

Determining the Infrastructure Needs to Support Offshore Floating Wind and Marine Hydrokinetic Facilities on the Pacific West Coast and Hawaii

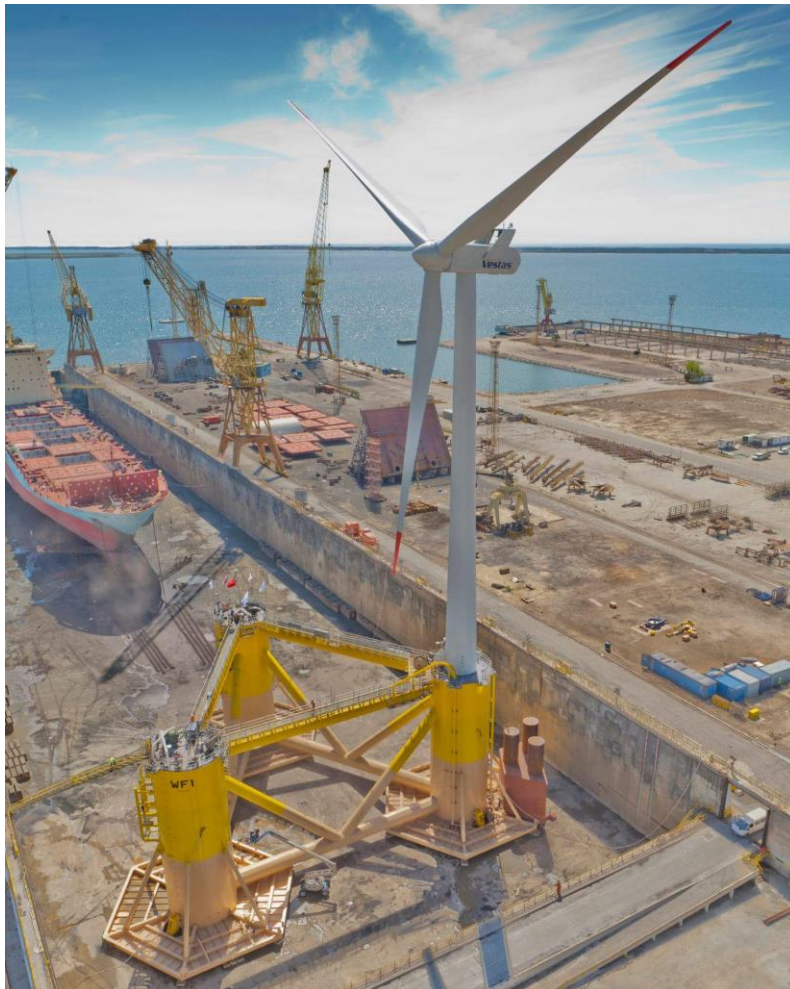

US Department of the Interior
Bureau of Ocean Energy Management
Pacific OCS Region

This page intentionally left blank.

Determining the Infrastructure Needs to Support Offshore Floating Wind and Marine Hydrokinetic Facilities on the Pacific West Coast and Hawaii

Authors

Aaron Porter and Shane Phillips
Coast & Harbor Engineering “A Division of Hatch Mott MacDonald”
110 James Street, Suite 101
Edmonds, WA 98020

Prepared under BOEM Contract
M15PD00019
by
ICF International
615 S.W. Alder Street, Suite 200
Portland, OR 97205

**US Department of the Interior
Bureau of Ocean Energy Management
Pacific OCS Region
March 3, 2016**



DISCLAIMER

Study concept, oversight, and funding were provided by the US Department of the Interior, Bureau of Ocean Energy Management, Environmental Studies Program, Washington, DC, under Contract Number M15PD00019. This report has been technically reviewed by BOEM and it has been approved for publication. The views and conclusions contained in this document are those of the authors and should not be interpreted as representing the opinions or policies of the US Government, nor does mention of trade names or commercial products constitute endorsement or recommendation for use.

REPORT AVAILABILITY

To download a PDF file of this Environmental Studies Program report, go to the US Department of the Interior, Bureau of Ocean Energy Management, [Environmental Studies Program Information System](#) website and search on OCS Study BOEM 2016-011.

This report can be viewed at select Federal Depository Libraries. It can also be obtained from the National Technical Information Service; the contact information is below.

US Department of Commerce
National Technical Information Service
5301 Shawnee Rd.
Springfield, VA 22312
Phone: (703) 605-6000, 1(800)553-6847
Fax: (703) 605-6900
Website: <http://www.ntis.gov/>

CITATION

A. Porter and S. Phillips. 2016. *Determining the Infrastructure Needs to Support Offshore Floating Wind and Marine Hydrokinetic Facilities on the Pacific West Coast and Hawaii*. US Department of the Interior, Bureau of Ocean Energy Management, Pacific OCS Region, Camarillo, CA. OCS Study BOEM 2016-011. 238 pp.

Table of Contents

LIST OF FIGURES	V
LIST OF TABLES	VI
ABBREVIATIONS AND ACRONYMS	VII
GLOSSARY	IX
1. INTRODUCTION.....	1
2. BASIS OF ANALYSIS AND EVALUATION CRITERIA.....	3
2.1 INTRODUCTION	3
2.2 BASIS OF ANALYSIS	3
2.2.1 Device Type and Components.....	3
2.2.2 Geographic Location	9
2.2.3 Metocean Conditions.....	11
2.2.4 Jones Act	12
2.3 EVALUATION CRITERIA	12
2.3.1 Port Functions	12
2.3.2 Supply Chain Logistics	17
2.3.3 Vessels.....	18
2.3.4 Assembly and Installation.....	19
3. ASSESSMENT OF VESSEL REQUIREMENTS TO SUPPORT OFFSHORE FLOATING WIND AND MARINE HYDROKINETIC TECHNOLOGY ON THE PACIFIC WEST COAST.....	21
3.1 INTRODUCTION	21
3.2 PROTOTYPE ANALYSIS.....	21
3.2.1 Existing Industry Prototypes.....	21
3.2.2 Demonstration-Scale OFW and MHK.....	25
3.2.3 Oil and Gas Industry – Floating Structures.....	30
3.3 METOCEAN ENVIRONMENT CONSIDERATIONS	33
3.3.1 Metocean Conditions.....	33
3.4 PROTOTYPE INDUSTRY VESSEL APPLICABILITY AND AVAILABILITY ANALYSIS ...	35
3.5 VESSEL INFRASTRUCTURE REQUIREMENTS	35
3.5.1 Vessel Activity Phases	35
3.5.2 Potential Vessel Fleet Database	36
3.6 KEY FINDINGS	42

4. ASSESSMENT OF PORT INFRASTRUCTURE CHARACTERISTICS NEEDED TO SUPPORT FLOATING OFFSHORE WIND AND MARINE HYDROKINETIC TECHNOLOGIES	46
4.1 INTRODUCTION	46
4.2 PROTOTYPE ANALYSIS.....	46
4.2.1 Fixed Foundation Offshore Wind	46
4.3 DEMONSTRATION-SCALE PROJECTS.....	51
4.3.2 Marine Hydrokinetic.....	53
4.3.3 Ocean Power Technologies	53
4.3.4 Oil and Gas Industry	54
4.4 REGULATIONS AND GUIDELINES.....	55
4.4.1 PIANC	55
4.4.2 U.S. Department of Transportation	56
4.4.3 Occupational Safety and Health Administration	56
4.4.4 American Bureau of Shipping.....	56
4.5 VESSEL NAVIGATION AND BERTHING.....	56
4.5.1 Navigation	56
4.5.2 Berthing.....	57
4.6 PORT INFRASTRUCTURE REQUIREMENT CRITERIA RESULTS	58
4.6.1 Quick Reaction Ports.....	58
4.6.2 Fabrication and Construction Ports.....	60
4.6.3 Assembly Ports	64
4.6.4 Cluster Ports	67
4.7 SUMMARY AND NEXT STEPS	67
4.8 KEY FINDINGS	67
5. CANDIDATE PORT PRE-SCREENING ANALYSIS	70
5.1 INTRODUCTION	70
5.2 SCREENING CLASSIFICATIONS.....	70
5.3 PRELIMINARY PORT SCREENING CRITERIA AND DATABASE	70
5.3.1 Navigation Access	70
5.3.2 Port Facility Infrastructure	72
5.4 PRE-SCREENING ANALYSIS AND RESULTS	74
5.4.1 California	76
5.4.2 Oregon	78
5.4.3 Washington.....	81
5.4.4 Hawaii.....	84
5.5 KEY FINDINGS	86

6. INVENTORY OF PACIFIC WEST COAST AND HAWAII CANDIDATE PORT FACILITIES AND CHARACTERISTICS	88
6.1 PORT ASSESSMENTS.....	88
6.1.1 Southern California	90
6.1.2 Northern California.....	92
6.1.3 Oregon and Northern California Coasts	93
6.1.4 Columbia River.....	95
6.1.5 Southwest Washington	97
6.1.6 Puget Sound.....	98
6.1.7 Hawaii.....	99
7. KEY STUDY FINDINGS AND CONCLUSIONS.....	101
7.1 KEY FINDINGS - PORTS AND NAVIGATION.....	101
7.1.1 OFW and MHK – General Findings.....	101
7.1.2 OFW – Primary and Secondary Findings	102
7.1.3 MHK Findings.....	103
7.1.4 Marine Navigation Assessment.....	103
7.2 KEY FINDINGS - VESSELS.....	104
7.2.1 Vessels – Primary Findings	105
7.2.2 Vessels – Secondary Findings	105
7.3 GENERAL STUDY CONCLUSIONS.....	106
7.4 PORT CLASSIFICATIONS CONCLUSIONS	107
7.4.1 Quick Reaction	107
7.4.2 Fabrication and Construction.....	107
7.4.3 Assembly	108
7.5 CURRENT STATE OF PORT INFRASTRUCTURE TO SUPPORT DEMONSTRATION- AND COMMERCIAL-SCALE OFW AND MHK.....	109
7.5.1 Demonstration-scale.....	109
7.5.2 Commercial Scale.....	109
8. REFERENCES.....	111
APPENDIX A. INVENTORY OF PACIFIC WEST COAST CANDIDATE PORT FACILITIES AND CHARACTERISTICS	117
APPENDIX B. WEST COAST AND HAWAII PORT DATABASE	190
APPENDIX C. PRELIMINARY PORT NAVIGATION ACCESS AND INFRASTRUCTURE DATABASES USED FOR PRE-SCREEN ANALYSIS.....	194
APPENDIX D. VESSEL APPLICABILITY CURSORY AVAILABILITY ASSESSMENT	199

APPENDIX E. VESSEL FLEET.....	202
APPENDIX F. ROAD AND RAIL TRANSPORT EVALUATION CRITERIA.....	209
APPENDIX G. VESSEL NAVIGATION AND BERTHING ANALYSIS.....	211
APPENDIX H. OFFSHORE WIND AND MARINE HYDROKINETIC PORT FACILITY LITERATURE REVIEW NOTES.....	216
APPENDIX I. HELIPAD REQUIREMENTS.....	224
APPENDIX J. FLOATING WIND PROJECTS, INCLUDING DEMONSTRATION-SCALE PROJECTS.....	226
APPENDIX K. SELECTED U.S. FLEET LOCATION SNAPSHOT.....	229
APPENDIX L. GEODATABASE OVERVIEW.....	232

List of Figures

Figure 2-1. Floating wind foundation types (Principle Power 2016)	5
Figure 2-2. Active wind-related manufacturing facilities at end of 2014 (AWEA 2015)	7
Figure 2-3. Wave Energy Converters types to be included in study (Columbia Power 2016, OmniGlobal 2015, PNNL 2014, Langlee Wave Power 2016)	8
Figure 2-4. Ocean Current Mean Annual Power Density (NREL 2015).....	9
Figure 2-5. Potential port locations	10
Figure 2-6. Example wave rose and wave height exceedance information.....	11
Figure 2-7. Example Crew Transfer Vessel at port (Opus Marine 2013)	14
Figure 2-8. Example of Constructed Component Transport (Renewable Energy Focus 2009).....	15
Figure 2-9. Example offshore wind (fixed foundation) Cluster Port in Bremerhaven, Germany (Eurogate 2015) 16	
Figure 2-10. U.S. Class 1 railroads (Freight Rail Works 2010)	17
Figure 2-11. Example wind turbine component delivery vessel (AAL Shipping, 2015).....	19
Figure 2-12. Example offshore wind staging area with land-based crane >300 ft. in height (Harland and Wolff 2010)	20
Figure 3-1. Typical vessel activities for fixed foundation offshore wind turbine energy farms (The Crown Estate (U.K.) 2016).....	22
Figure 3-2. Floating Crane Barge.....	24
Figure 3-3. Semi-Sub demonstration project installation (WindFloat, 2014)	25
Figure 3-4. Spar demonstration project installation example (Hywind 2015)	26
Figure 3-5. GICON-SOF TLP installation concept (GICON-SOF 2016)	27
Figure 3-6. Example Multicat Vessel at a Pelamis device (Delta Marine 2013).....	28
Figure 3-7. Wello Penguin Installation at EMEC by two multicat tugs (CEFOW 2015)	28
Figure 3-8. Spar (left panel) and Semi-Sub (right panel) towed by two Crowley Ocean Tugs (150-ton bollard pull each), with a support tug as auxiliary (Crowley 2013).....	31
Figure 3-9. Installation of Semi-Sub FPU utilizing tugs in star formation (Crowley 2014)	32
Figure 3-10. Floating cranes, Manson 1000 ton E.P. Paup (Manson, 2015).....	32
Figure 3-11. Example of Multi-purpose Vessel - Fugro Symphony (Fugro Symphony 2016)	38
Figure 4-1. BOW Terminal handling foundations (BOW Terminal 2014, Renews 2014).....	47
Figure 4-2. Existing Bremerhaven port terminal. (Bremerhaven Port 2016)	47
Figure 4-3. Hywind construction location in Pori, Finland (Technip 2013)	51
Figure 4-4. New potential Hywind installation procedures (Statoil 2015)	52
Figure 4-5. Pelamis device installation (Yemm <i>et al.</i> 2011).....	53
Figure 4-6. Example of staged full-size MHK device using scaffolding (Hug Energy Inc. 2015).....	54
Figure 4-7. MHK barge loading at Oregon Iron Works (NWSM 2013).....	54
Figure 4-8. Gulf Island Fabrication Company, Ingleside, Texas. (Center for Land Use Interpretation 2016)	55
Figure 4-9. Navigation channel width (left panel) and depth (right panel) diagrams (USACE 2006)	57

Figure 4-10. Conceptual-level vessel berthing diagram.....	58
Figure 4-11. Example of specialized upland equipment to maneuver blades (Siemens 2014).....	61
Figure 5-1. Port of Astoria and Astoria Bridge (Longshore Shipping News 2012).....	80
Figure 5-2. Grays Harbor Casting Basin for SR 520 Pontoons (Washington State Department of Transportation 2013)	83
Figure 5-3. Available depths and assembly ports in Puget Sound region (NOAA 2003)	84

List of Tables

Table 2-1. Prototypical floating and fixed offshore wind turbine geometry (6-8 MW)	4
Table 2-2. Floating wind turbine foundation developers.	4
Table 2-3. Summary of offshore floating wind device foundation characteristics.....	5
Table 2-4. Floating wind foundation types and parameters	6
Table 2-5. Assumed MHK device types and characteristics.....	8
Table 2-6. Port classification functions.....	13
Table 3-1. Example vessels required for fixed foundation activities	23
Table 3-2. Summary of Example Installation Vessels for OFW Demonstration Projects.	27
Table 3-3. Select Demonstration-scale MHK Device Installations.	28
Table 3-4. WEC Vessel Requirements (summarized from Slevin <i>et al.</i> 2012)	29
Table 3-5. Vessel dimensions.....	30
Table 3-6. Prototype oil and gas floating structures compared to OFW foundations	31
Table 3-7. Prototype fleet required for FPU transport and installation.....	32
Table 3-8. Metocean database summary	33
Table 3-9. Vessel metocean considerations.....	34
Table 3-10. Potential vessel activities (OFW and MHK).....	35
Table 3-11. Survey vessels.....	37
Table 3-12. Sub-sea work vessels.....	37
Table 3-13. Towing and transport vessels	38
Table 3-14. Assembly support vessels.....	40
Table 3-15. Installation support vessels.....	41
Table 3-16. Operation and maintenance vessels.....	42
Table 3-17. Potential vessel fleet shown by port classification.....	43
Table 4-1. Prototype port characteristics	48
Table 4-2. Literature review notes of fixed-foundation offshore wind characteristics as applied to OFW assembly ports (FCP, QRP as noted).....	49
Table 4-3. Quick Reaction Port facility criteria.....	59
Table 4-4. Fabrication and Construction Port facility criteria.....	62
Table 4-5. OFW Assembly Port facility criteria.....	64
Table 4-6. MHK Assembly Port facility criteria	65
Table 5-1. Pre-screen navigation access characteristics.....	71

Table 5-2. Pre-screen port infrastructure characteristics.....	74
Table 5-3. Pre-screening analysis key abbreviations.....	75
Table 5-4. Pre-screening analysis legend.....	75
Table 5-5. California ports pre-screening analysis.....	76
Table 5-6. Oregon ports pre-screening analysis.....	78
Table 5-7. Washington ports pre-screening analysis.....	81
Table 5-8. Hawaiian ports pre-screening analysis.....	85
Table 6-1. Port assessment scoring matrix.....	89
Table 6-2. Scoring summary: Southern California.....	91
Table 6-3. Regional gap analysis: Southern California.....	91
Table 6-4. Scoring summary: Northern California.....	93
Table 6-5. Regional gap analysis: Northern California.....	93
Table 6-6. Scoring summary: Oregon and Northern California coasts.....	94
Table 6-7. Regional gap analysis: Oregon and California coastal ports.....	95
Table 6-8. Scoring summary: Columbia River.....	96
Table 6-9. Regional Gap Analysis: Columbia River.....	96
Table 6-10 Scoring summary: SW Washington.....	97
Table 6-11. Scoring summary: Puget Sound.....	98
Table 6-12. Regional gap analysis: Washington.....	99
Table 6-13. Scoring summary: Hawaii.....	100
Table 6-14. Regional Gap Analysis: Hawaii.....	100

Abbreviations and Acronyms

ABS	American Bureau of Shipping
AHTS	Anchor Handling Tug Supply
AP	Assembly Port
ATR	Above Top of Rail
BOA	Basis of Analysis
BOEM	Bureau of Ocean Energy Management
BOW	Breakbulk and Offshore Wind
CTV	Crew Transfer Vessel
DWT	Deadweight tonnage
EMEC	European Marine Energy Centre
E.U.	European Union

Gross Tonnage	Gross Tonnage
HMM	Hatch Mott MacDonald
Hs	Significant Wave Height
Ft.	Feet
FCP	Fabrication and Construction Port
FPU	Floating Production Unit
LOA	Length Overall
m	Meter
MHK	Marine Hydrokinetic
MLLW	Mean Lower Low Water
mph	Miles per Hour
MPV	Multi-Purpose Vessel
mt	Metric Tons
MW	Megawatts
nmi	Nautical Miles
NOAA	National Oceanic and Atmospheric Administration
NDBC	National Data Buoy Center
O & M	Operations and Maintenance
OCS	Outer Continental Shelf
OCV	Offshore Construction Vessel
OFW	Offshore Floating Wind
PIANC	Permanent International Association of Navigation Congresses
psf	Pounds per Square Foot
QR	Quick Response
QRP	Quick Reaction Port
ROV	Remote Operated Vehicle
sec	Second
Semi-Sub	Semi-Submersible
SOW	Scope of Work
SPMT	Self-propelled Modular Transporter
SR	State Route

Tp	Peak Wave Period
U.K.	United Kingdom
U.S.	United States
WEC	Wave Energy Converter
WTG	Wind Turbine Generator

Glossary

Aids to Navigation	Device external to a vessel designed to assist in the determination of its position and its safe course or to warn of changes or obstructions. In the case of channels such devices include buoys, piled beacons, leading lights, sector lights, radar reflectors, etc.
Air Draft	Vertical distance measured from the device/vessel waterline to the highest point on the device/vessel.
Anchor Handling Tug Supply (AHTS) Vessel	Anchor Handling Tug Supply (AHTS) vessels are designed and equipped for anchor handling and towing operations. They are also used for rescue purposes in emergency cases.
Anchors	Secures the mooring lines to the seafloor. May be embedded, grouted, gravity or other type of anchors.
Assembly Port (AP)	Will be utilized during final assembly of the entire device for marine tow out to the installation location.
Assist Tug	Tugboat capable of less than 70 tons bollard pull which is used to either support other marine activities or may provide tow services.
Berth	Designated location where a vessel may be moored.
Blades	React to wind so that they rotate the rotor. Blades are considered part of the rotor.
Bulk Carrier	Vessel which provides transport of bulk or breakbulk cargo such as OFW nacelles, blades, hubs, etc.
Bunkering	The process of refueling ships.
Cable Laying Vessel	Deep sea vessel used to lay underwater cables.
Commercial-Scale	Ocean energy farms which consists of approximately 30 or more devices (MHK or OFW). (Terminology for farms between 5-30 devices in development).
Deadweight tonnage (DWT)	Weight (usually in metric tonnes) of a ship's cargo, fuel, water, crew, passengers and stores.
Deck Barge	Barge without spuds, requiring towing from a tug.
Demonstration-scale	Ocean energy farms which consists of approximately 5 or fewer devices (MHK or OFW).
Device Width	The beam of the device during marine transport.
Draft	Submerged depth of the device/vessel.
Dry dock	A structure able to contain a ship and to be drained or lifted so as to leave the ship free of water with all parts of the hull accessible.
Dynamic Positioning	Computer-controlled system to automatically maintain a vessel's position and

	heading by using its own propellers and thrusters.
Fixed Foundation	Refers to non-floating offshore wind foundation, like turbines presently operating in Europe.
Floating Crane	Barge outfitted with a crane.
Gross Tonnage (GT)	Measure of the overall size of a ship determined in accordance with the provisions of the International Convention on Tonnage Measurement of Ships, 1969. No units required as it is a non-dimensional quantity.
Handymax	Handymax vessel typically has a capacity between 35,000 and 50,000 DWT.
Handysize	Handysize vessel is typically a dry bulk carrier with a capacity between 15,000 and 35,00 DWT.
Hub	Part of the rotor and connects the wind turbine blades to the nacelle.
Fabrication and Construction Port (FCP)	Handle device components, sub-component assembly, and serve as a transport hub for overland or marine transport, and may construct larger device components.
Jack-up Barge	Typically a barge outfitted with a crane and spuds. The spuds are deployed into the water to the seafloor and provide stability to the barge which is lifted out of the water.
Jones Act	Prohibits any foreign built or foreign flagged vessel from engaging in coastwise trade within the United States.
Marine Railway	Tracks leading into the water so that a ship or other device can be transported to uplands from the water
Marine Hydrokinetic (MHK)	Ocean wave energy converter or ocean current energy converter devices.
Metocean Conditions	Wind, wave, ocean current, and tide conditions.
Mooring Lines	Lines which secure the device to anchors located on the seafloor.
Multicat	Multi-purpose tug (typically shallow draft) outfitted with one or two cranes. Typically has deck space for storage and maneuvering or cargo. May be capable of handling buoys and anchors depending on size and metocean conditions.
Multi-purpose Vessel	Large vessel capable of providing a range of offshore services such as ROV support, dive support, heavy tow, and mooring installation.
Nacelle	Sits on top of the tower and is connected to the rotor. Houses mechanical components.
Ocean Current Energy Converter	Convert ocean currents energy into electrical power.
Ocean Tug	Tug capable of providing service in ocean environments.
Offshore Construction Vessel	Large vessel capable of provide offshore construction and lift services such as ROV support, crane use, and mooring installation.
Offshore Floating Wind (OFW)	Floating wind turbines.
Peak Wave Period (T_p)	Peak wave energy period
Power Rating	Nameplate capacity rating. The maximum potential power output of the turbine generator at the time of installation.
Quick Response (QR) Port	Intended to be the homeport for operations and maintenance vessels.
Rotor	Consists of blades fixed to the hub.

Semi-Submersible (Semi-Sub)	Floating wind turbine foundation partially submerged in the water with a traditional mooring line system.
Significant Wave Height (Hs)	Average of top one third of measured wave heights
Spar	Approximately 70-85 m draft floating ballasted cylinder offshore wind turbine foundation.
Tension Leg Platform (TLP)	Floating wind-turbine foundation, anchored to seafloor with tension lines.
Tower	This is the support column for wind turbine.
Wave Energy Converter	Convert ocean wave energy captured directly from surface waves or from pressure fluctuations below the surface into electrical power.

1. Introduction

As the offshore renewable industry continues to develop and grow, the capabilities of established port facilities on the Pacific west coast of the United States (U.S.) and the Hawaiian islands of Oahu, Maui, and Kauai need to be assessed as to their ability to support the expanding offshore floating wind (OFW) and marine hydrokinetic industries (MHK). The Pacific Coast is characterized by rapidly increasing water depths that exceed the feasible limits of fixed platforms on the outer continental shelf (OCS) making the west coast more suitable to floating wind technology. This study shall assess current infrastructure requirements and projected changes to port facilities that may be required to support the OFW and MHK industry for Pacific west coast harbors and ports. The assessment of the infrastructure and available support facilities, vessels, and equipment necessary to support offshore renewable energy activities will aid in the environmental reviews and evaluations that will be required of future projects. Information obtained from this study and identified in this report will aid in the development of mitigation measures designed and initiated to minimize effects from offshore renewable energy activities to ensure environmentally safe and sound operations. Understanding the infrastructure needs of the offshore renewable industry will help to identify the port-related requirements for OFW and MHK development and assess the utilization of the available marine equipment and facilities along the U.S. West Coast.

The capabilities of established port facilities to support OFW and MHK are assessed in this study by evaluation of the following objectives:

- Vessel Requirements and Characteristics of OFW and MHK
- Assessment of Infrastructure Needs on the Pacific West Coast and Hawaii to Support OFW and MHK
- Inventory of Pacific West Coast and Hawaii Candidate Port Facilities and Characteristics

Findings of these objectives are described in the following chapters and are used to identify harbor and port facilities on the Pacific West Coast and islands of Hawaii that currently have capabilities, or can potentially have the capability with infrastructure improvements, to support large-scale (i.e., 30+ devices) OFW and MHK development. The capabilities of existing port infrastructure to support smaller demonstration-scale (i.e., 1-5) OFW and MHK projects are also included in this report.

The OFW and MHK industries are both in early stages of development, with no floating large-scale offshore energy farms yet deployed globally. The offshore wind energy market in Europe is well developed, but currently relies on shallower water, fixed foundation, installations. Small-scale OFW and MHK projects have been demonstrated and have generated electricity, but are not yet installed on a large commercial scale in the U.S. or elsewhere. Therefore, there is no existing industry to directly base evaluation criteria on for this study and instead, criteria must be developed based on existing information, similar industries, and assumed device characteristics.

To establish parameters for the study and to describe evaluation criteria developed in lieu of existing industry, the Basis of Analysis is presented in Chapter 2. The basis of analysis describes the energy device technologies included in the study, the geographic region of study, and study assumptions. The basis of analysis was initially developed as a separate document, and due to the dynamic nature of a nascent industry it was continually refined as the study progressed. The evaluation criteria described in Chapter 2 establish different criteria dependent on the different functions port may provide to support OFW and MHK development.

Ports were classified into the following categories based on available port, vessel, supply chain and assembly criteria presented in Chapter 2:

- Ports suitable for device assembly
- Ports suitable for device fabrication and construction facilities
- Quick Reaction Ports (located within 2 hours by vessel of a potential installation site)

The remaining chapters assess vessel and port infrastructure and develop findings for the study objectives. Vessel requirements to support OFW and MHK are assessed in Chapter 3. Findings related to estimated fleet requirements for the OFW and MHK technologies developed in turn support development of port facility infrastructure needs by establishing the vessels required to be accommodated by ports. Navigation requirements, port facility infrastructure, and supply chain characteristics of ports likely able to support OFW and MHK are described in Chapter 4. These requirements are based on review of the estimated vessel fleet, characteristics of offshore wind port facilities in Europe, literature review of potential requirements for fixed foundation offshore wind farms in the U.S., and other guidelines.

Information on existing and potential port characteristics was collected during the course of the study and results of this data collection effort are included in database format within this report, as well as narratives to capture non-quantitative aspects from the ports that may affect assessments. The information collected and presented in this study are not comprehensive, but include the information necessary to assess the capability of each port to potentially support OFW or MHK development. In Chapter 5, the ports in the study area are pre-screened into different classifications of providing potential port functions for further investigation, based on select information in the port database and several preliminary key navigation and facility characteristics developed for screening the ports. Results of this analysis aid in focusing an assessment of refined port navigation and facility characteristics in Chapter 6.

In Chapter 6, the ports are assessed against port facility, navigation, and supply chain criteria for different potential technologies and functions to support the industries, according to the classifications assigned in the pre-screening analysis. It is difficult to establish that ports can or cannot support specific OFW or MHK technologies in the near future because installation technology of these industries is still in development to improve the economics of installation globally. The study can therefore only assess port capabilities relative to existing proven technology. Based on existing technology, this study presents assessments of ports following a conceptual-level scoring matrix, relative to technology and function specific criteria. The scoring matrix is intended to estimate the relative levels of investment to support commercial-scale OFW and MHK, for existing installation technology. Results of port assessments are presented by region. Chapter 7 presents the conclusions and recommendations for the interpretation of port facilities to support the OFW and MHK industries on the Pacific West Coast and Hawaii.

2. Basis of Analysis and Evaluation Criteria

2.1 Introduction

This chapter describes the basis for analysis and evaluation criteria used to assess the infrastructure and vessel requirements to support commercial development of OFW and MHK. The assumptions and criteria described within are used to both develop the database of existing West Coast and Hawaiian Ports, and evaluate those ports relative to infrastructure requirements.

In this chapter, different classifications of ports are identified (i.e., Assembly, Fabrication and Construction, and Quick Response). In this study, ports are assessed against the appropriate classifications for the port and the different potential technology to be supported. The basis of analysis outlines the scope and basis for the study and is described in the section that follows. The evaluation criteria (Section 2.3) outlines the criteria the ports are assessed relative to, including port criteria, vessel criteria, supply chain criteria, and assembly criteria.

2.2 Basis of Analysis

The basis of analysis describes the OFW and MHK devices, geographic areas of interest evaluated in the study, and other relevant basic assumptions. Developing the components for analysis was the first step of the project development process and has been utilized as a basis for evaluation of port and vessel infrastructure for the study area. This section attempts to bracket the potential devices and installation technologies to provide a snapshot of the requirements at the present time, and potential technological developments required for commercial development.

2.2.1 Device Type and Components

This section describes the device prototypes to be assessed in the study. OFW and MHK components have some similarities in material, but in general, components related to OFW are significantly larger. For this study it is assumed that the prototypical commercial OFW/MHK farm consists of 30 or more devices, and potentially more than 100 devices. At present no commercial-scale (i.e., 30+ units) OFW or MHK farms are operating worldwide. No fixed-foundation offshore wind farms are currently in operations in U.S. waters, though one is presently under construction in Rhode Island (five jacket foundations installed in 2015), as of February, 2016. The largest producing wind farm outside the U.S. consists of 175 turbines and is rated at 630 megawatt (MW) (London Array, United Kingdom), with larger farms planned.

Demonstration-scale projects (approximately 1 to 5 devices) have different port infrastructure requirements than full commercial-scale projects, as the supply chain logistics and costs of scale will be significantly different. Scaling effects of demonstration-scale projects will be addressed in future phases of this study, however the primary focus will be on commercial-scale (30+ units) device energy farms.

2.2.1.1 Offshore Floating Wind

Turbine Selection and Components

OFW turbines are similar to the fixed-foundation offshore wind turbine technologies installed in Europe except that the foundation is floating rather than fixed to the seafloor. Floating wind turbine technology and sizes are similar to or larger than those used in the fixed-foundation turbine farms. The same turbine type may be used with different foundation technology (fixed or floating). For this study, it is assumed that commercial-scale offshore wind farms will utilize 6-8 MW or larger turbines. This size of turbine is selected as they are already being considered for similar installations including the Alpha Wind Energy Lease Application, WindFloat specifications, and Hywind Scotland Park Project. Based on industry

research, and as a basis for the study, HMM developed prototypical turbine component geometries and weights for typical OFW turbine technology which are shown in Table 2-1.

Table 2-1. Prototypical floating and fixed offshore wind turbine geometry (6-8 MW)

Component	Geometry	Total Component Weight
Tower	250-460 ft. height, 13-21 ft. diameter. Typically transported in 3-4 pieces.	~400 tons (in multiple pieces)
Hub	10-20 ft. Diameter, single piece.	50-85 tons
Blades	230-260 ft. length, single piece only.	~30-40 tons per blade
Nacelle	~50 ft. long ~20 ft. high May be transported in pieces overland	350-400 tons

Floating Wind Turbine Foundation Selection and Components

Most OFW technologies can be classified into three technology types: Semi-submersible (Semi-Sub); Tension-leg platform (TLP); and Spar-buoy (Spar). Examples of the floating foundation types are shown in Figure 2-1, and briefly described in Table 2-3. Table 2-2 shows a summary of OFW foundation technologies in development in the U.S. and around the world.

Table 2-2. Floating wind turbine foundation developers

Technology Name	Type	Location
WindFloat – Principle Power	Semi-submersible	Seattle, USA
VoltumUS - UMaine	Semi-submersible	Maine, USA
Nautica Wind Power	Semi-Submersible	USA
PelaStar - Glosten	Tension Leg Platform	Seattle, USA
Hywind – Statoli/Siemens	Spar-Buoy	Norway
GOTO FOWT	Semi-Submersible	Japan
Fukushima	Semi-Submersible	Japan
Poseidon Floating Wind	Semi-Submersible	Denmark
WINFLO – Nass and Wind	Semi-submersible	France
FloatGen	Semi-submersible	France
Blue H TLP	Tension Leg Platform	The Netherlands
Floating Halidade - Alstom	Tension Leg Platform	International/M.I.T.
IDEOL	Tension Leg Platform	France
Hexicon	Tension Leg Platform	Sweden
GICON-SOF	Tension Leg Platform	Germany

Appendix J contains a more detailed table of commercial- and demonstration-scale OFW technology projects which have been installed, planned, or cancelled. The technologies are in some cases similar to

floating-foundation technologies utilized for the offshore oil and gas industry. The study incorporates the three potential floating-foundation types. This study will not include fixed-foundation technologies, but due to similarities in fabrication requirements fixed-foundation projects are referenced as prototype examples.

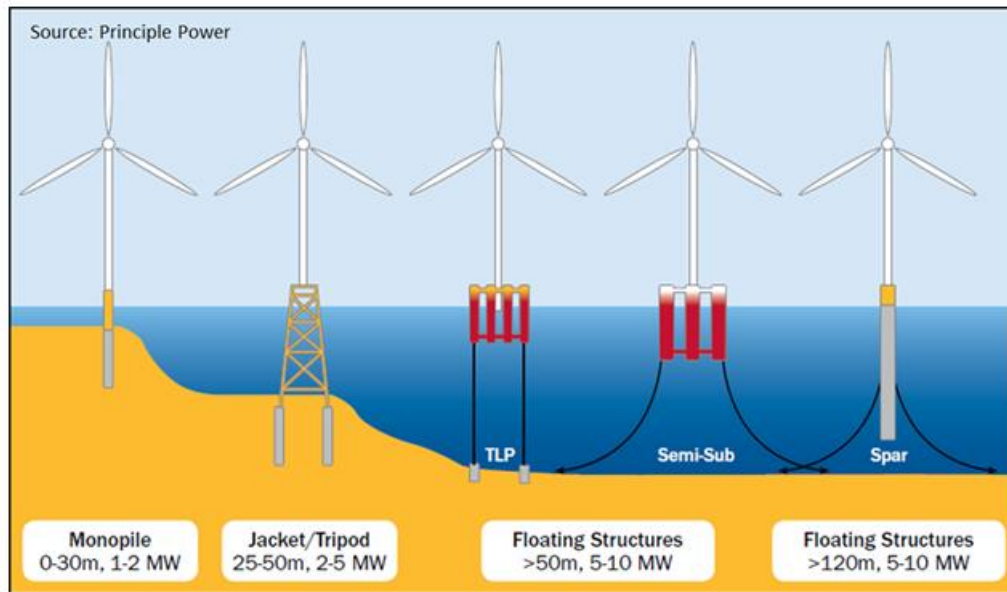

Figure 2-1. Floating wind foundation types (Principle Power 2016)

Table 2-3. Summary of offshore floating wind device foundation characteristics

Device	Material	Installation Concept	Primary Installation Vessels	Other
Semi-Sub	Steel	Assembled in port & towed to site	Anchor Handling Tug, support tugs	May be constructed in dry dock
TLP	Steel	Assembled in port & towed to site	Multiple Ocean Tugs	
Spar	Steel	In development. Prototype assembled in protected deep water location	Anchor Handling Tug, Crane Barge	May be towed horizontally to assembly site.

Differences of the floating foundation types may require variations in assembly, transport, and installation, as shown in Table 2-1. Evaluation and assessments included in this study are based on the floating wind turbine geometries and characteristics outlined in Table 2-4. Assumed device characteristics were developed based on communication with technology developers, review of publicly available publications, and coordination with BOEM. The device geometries are critical to determine the required support vessels and port facility infrastructure. Device parameters are in continuous refinement due to the nature of a nascent industry, future technology developments may result in refinement of these parameters. Specific mooring and anchoring requirements differ for the types of floating foundations and geotechnical conditions found at the project sites, and these details are outside the scope of this document.

Table 2-4. Floating wind foundation types and parameters

Component	Semi-Sub	Spar	TLP
Power Rating	6-10 MW	6 MW	6-10 MW
Draft (In Transit)	~10-12 m	~10 m to ~80 m, depending on installation method.	~8-10 m
Draft (Installed)	~20 m	~80 m	~30 m
Width (Diameter)	~50 m	~8 m	~42-70 m
Air Draft	Up to ~200 m depending on installation method	Up to ~200 m depending on installation method	Up to ~200 m depending on installation method
Displacement	~6,000-8,000 tons	~13,000-15,000 tons	~4,000-8,000 tons
Mooring Lines	3-6 catenary lines (traditional)	3-6 catenary lines (traditional)	3-8 tension lines (tendons)
Anchors	Varies: Depends on seafloor (Suction piles, drag embedded anchors, grouted rock anchors, etc.)	Varies: Depends on seafloor (Suction piles, drag embedded anchors, grouted rock anchors, etc.)	Varies: Depends on seafloor (Suction piles, drag embedded anchors, grouted rock anchors, etc.)
Installation Depth	~40 m+	~120 m+	~60 m+
Location	3-200 nautical miles (nmi) offshore	3-200 nmi offshore	3-200 nmi offshore

Component Manufacturing Locations

Components of the offshore wind system may be fabricated worldwide for assembly in Oregon, California, Washington, or Hawaii. These components may be transported via barge, bulk carrier vessels, truck, or rail, dependent on the most economical option. There already exists a large manufacturing base for on-shore wind farm components in the United States, as shown in Figure 2-2. This figure shows the active wind-related manufacturing facilities at the end of 2014, as well as wind energy generating capacity in MW by state. These facilities could potentially be used to fabricate components used to construct offshore turbines. However, because the sizes of commercial-scale offshore wind turbines (6-8 MW) are larger than the existing on-land windfarm turbines in the U.S., fabrication and transport requirements will be greater than the existing on-land U.S. wind industry. For this study, it is assumed that the turbine components will either be fabricated at the OFW assembly site or fabricated away from the assembly site at another port in coastal areas in the project area, along the Gulf of Mexico, the Atlantic Coast of the U.S. or be fabricated internationally (Europe, Asia). Due to the size of the larger fabricated components (i.e., blades, hubs, and tower sections) it is assumed that direct port access is needed for transport. Smaller electrical gear (i.e., transformers, switchgear, converters) are assumed to be reasonably transported by truck or rail, and existing manufacturing facilities are assumed to exist in the U.S. Due to the highly skilled and experienced workforce in the U.S., it is assumed that most repairs and replacement components will be competitively sourced domestically. Very large or highly specialized components (e.g., mechanical gear reducers) may still need to be supplied by international companies even in the event of unexpected component failures and damage.

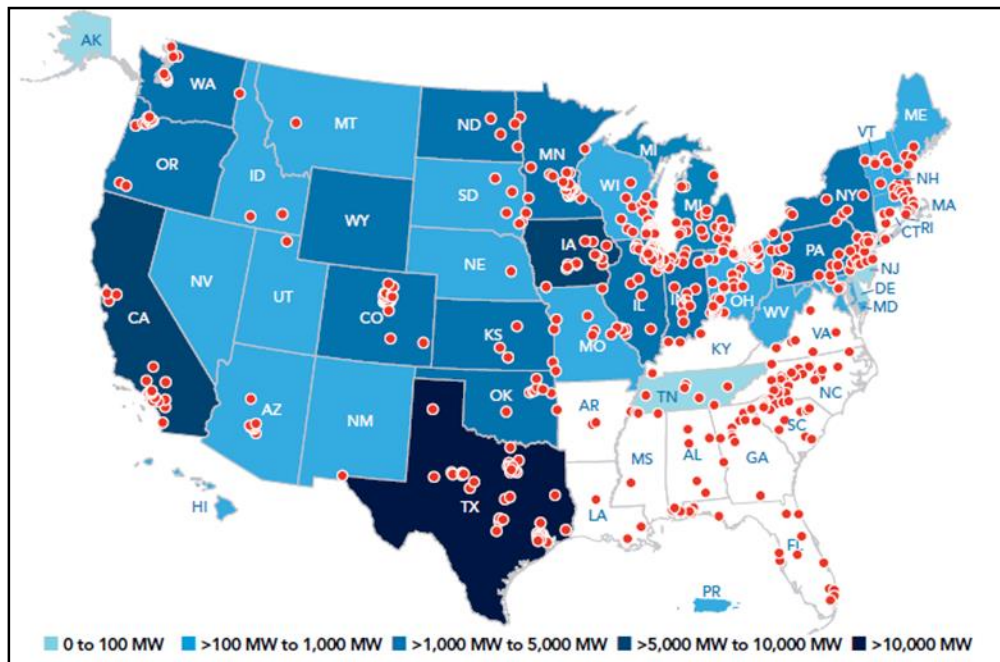

Figure 2-2. Active wind-related manufacturing facilities at end of 2014 (AWEA 2015)

Mooring and Anchoring

Commercial-scale OFW farms will require substantial mooring and anchoring installations. Anchor type is dependent on design load and sediment characteristics at the seafloor. Mooring systems are assumed to utilize conventional catenary spread mooring systems. Divers or remote operated vehicles (ROVs) may be required for support of mooring system assembly, and will be evaluated at a later stage. Existing OFW projects (i.e., WindFloat) are known to have used drag anchors.

2.2.1.2 MHK

MHK Technology Selection and Components

MHK technology is in a nascent stage of technology development, with few devices in the water, and none at commercial-scale development stage. The U.S. Department of Energy categorizes MHK into three categories: ocean wave energy; tidal stream; and ocean currents.

For this study HMM focuses on deep water floating ocean Wave Energy Converters (WECs) for deployment in BOEM submerged lands due to the available energy resources in the project area. In-lieu of the ability to analyze existing MHK systems, HMM has identified four potential prototype WEC-device types for deployment into MHK-farms for use in this study based on a screening analysis. Prototype component geometry is summarized in Table 2-5, and examples are shown in Figure 2-3. Though not indicated in Table 2-5, air draft will be a consideration in the study. Location of deployment is assumed to be between 3 nautical miles (nmi) and 30 nmi offshore. Device parameters were developed based on review of publically available publications, communication with developers, and coordination with BOEM.

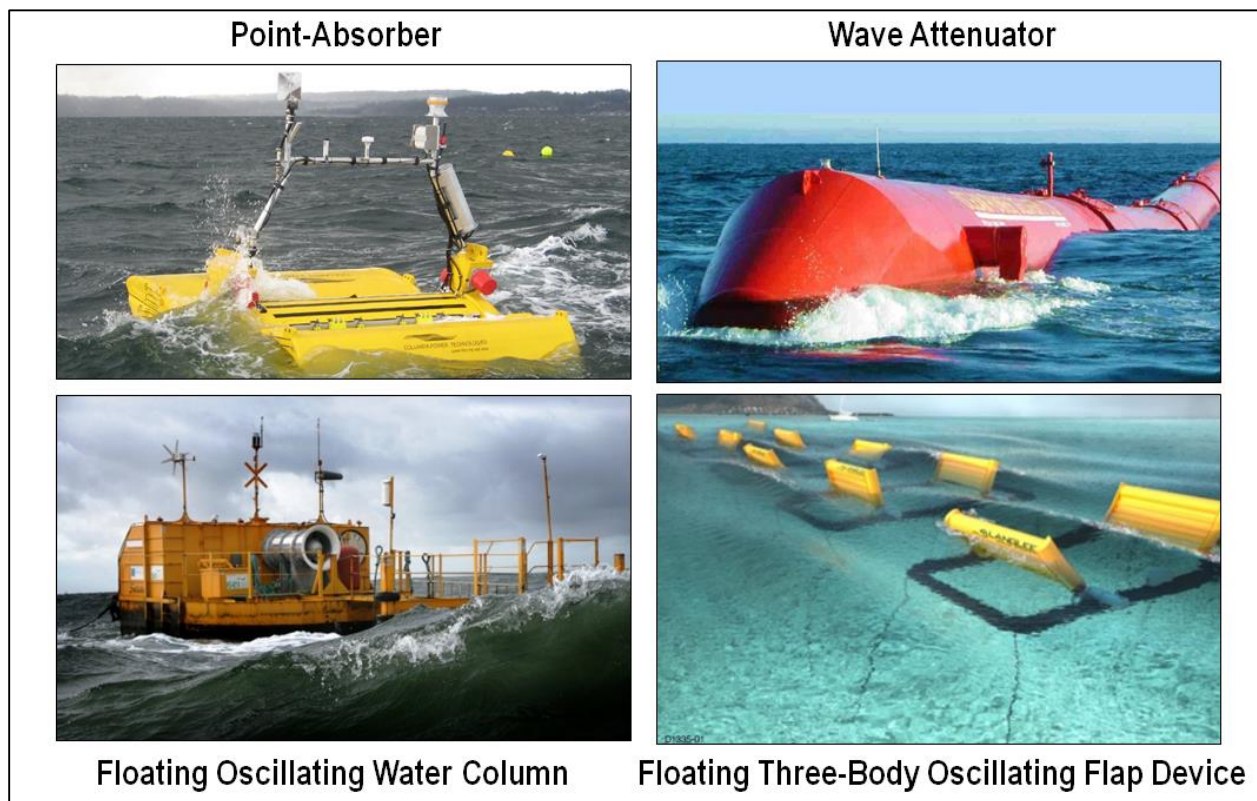

Figure 2-3. Wave Energy Converters types to be included in study (Columbia Power 2016, OmniGlobal 2015, PNNL 2014, Langlee Wave Power 2016)

Table 2-5. Assumed MHK device types and characteristics

Device Type	Water Depth	Approximate Displacement	Diameter	Installed Draft	Transport Draft
Floating Point-Absorber (e.g., Ocean Power Technologies, Columbia Power Technologies, Carnegie Wave Energy)	>20 m	~2000-5000 tons	~20 m	~50 m	~5-10 m
Attenuator (e.g., Pelamis)	>20 m	~1300 tons	4 m	2-3 m (~180 m length)	2-3 m
Wave Surge Converter (e.g., Langlee Wave Power)	>20 m	~700 tons	25 m	12 m	12 m
Floating Oscillating Water Column (e.g., Ocean Energy Ltd)	>20 m	~1800 tons	50 m x 25 m	13 m	13 m

Tidal turbines are assumed to be the offshore device of choice in Washington (i.e., San Juan Islands), and infrastructure needs may be similar to the needs of MHK devices. However, this device type is not the focus of this study. Figure 2-4 shows an assessment of energy production potential based on ocean

currents (including tidal currents) for the U.S., and indicates that the mean kinetic energy on the West Coast is significantly smaller than the Florida Coast. It is therefore assumed that ocean current energy production commercialization will most likely not be realized on the West Coast, and will not be a focus of this study.



Figure 2-4. Ocean Current Mean Annual Power Density (NREL 2015)

Mooring and Anchoring

Commercial-scale MHK device farms will require substantial mooring and anchoring installations and vessels. Anchor type is dependent on design load and sediment characteristics at the seafloor. Mooring systems are assumed to utilize conventional catenary spread mooring systems. Divers or ROVs may be required for support of mooring system assembly.

Manufacturing Locations

This study assumes that assembly or staging of the devices will be at a regional deep-water port (California, Oregon, Washington, Hawaii). Fabrication locations for the device components may be on the Pacific West Coast, Hawaii, elsewhere in the U.S., or located internationally. It is assumed that prior to installation of the devices, whether whole or in components, they will need to be transported (via ship or overland transport) to an assembly port on the Pacific West Coast or Hawaii. Limited MHK devices have been fabricated to date, and so supply chain logistics and manufacturing locations are less well-known than for offshore wind.

2.2.2 Geographic Location

2.2.2.1 Installation Locations

BOEM, as mandated by amendments to the Outer Continental Shelf (OCS) Lands Act Section 388(a) of the Energy Policy Act of 2005 (Pub. L. 109-58) was delegated authority by the Secretary of the Interior to regulate production, transportation, or transmission of renewable energy sources located on the OCS.

Irrespective of financial constraints, energy farm installations could be potentially located on the OCS out to the 200 nmi Exclusive Economic zone. However, due to limitations on commercial feasibility, it is assumed for this study that the potential wind farm locations are located within 30 nmi of the coast, and outside the 3 nmi state submerged lands of Oregon, California, and Hawaii. In Hawaii the study will focus on the islands of Oahu, Maui, and Kauai. Recent offshore windfarms in Europe have been up to 45 km (28 nmi) offshore, for example the Noblewind windfarm in Belgium.

On the West Coast, depths in the area of interest range from approximately 40 meters to over 1,000 meters, and vary considerably based upon local bathymetry. Around the Hawaiian Islands depths are generally 200 to 1000 meters or greater with patches of shallower waters less than 200 meters. Based on interviews with developers and marine contractors, the offshore distance of the study may be revised for commercial reasons.

2.2.2.2 Existing Ports

As part of this study, HMM reviewed existing harbor and port facilities on the Pacific West Coast to determine the capabilities required and available to support the adoption of commercial-scale OFW and MHK technologies. Facilities indicated in Figure 2-5 are assessed for existing infrastructure and potential future growth. Recommendations include candidate ports for each state on the Pacific West Coast which can serve a role supporting commercial deployment. The roles vary for different Ports depending on their available infrastructure and proximity to the energy farms.

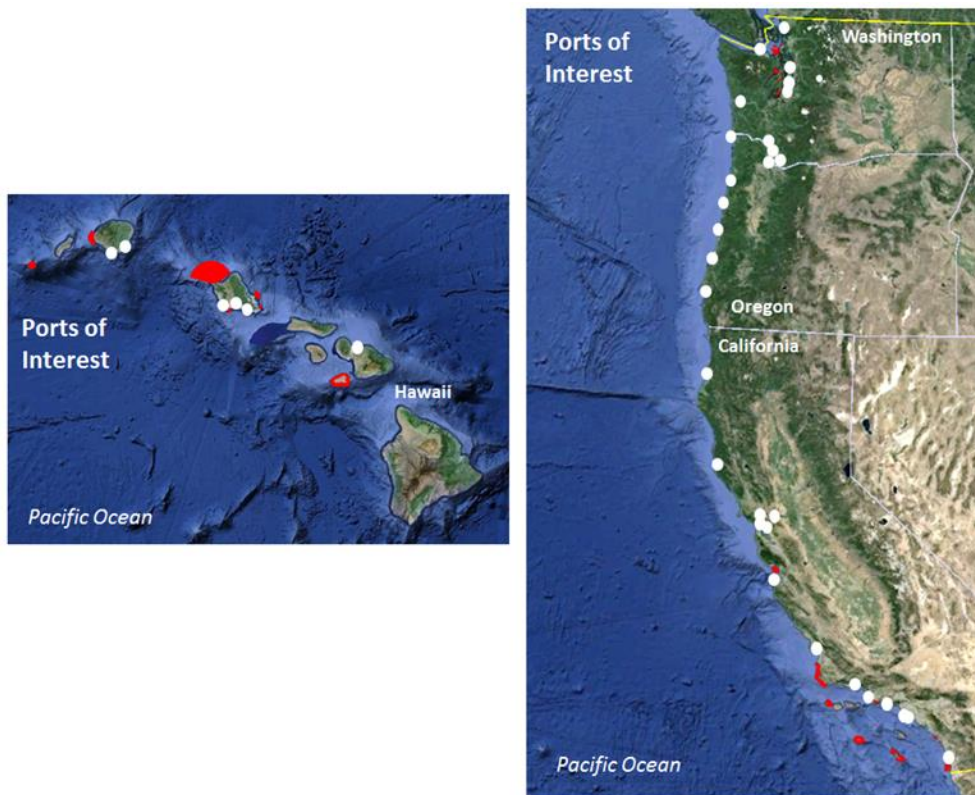

Figure 2-5. Potential port locations

Port locations are shown as white dots on Hawaii (left panel), and the Pacific West Coast (right panel). Example military restricted zones (Marine Cadastre 2015) are shown in red.

The geographic study area for port facilities considered in this study are shown in Figure 2-5. Discussions with marine contractors on the west coast indicated that port facilities in Washington State should also be considered as support facilities for assembly and installation support due to available deep navigable depths and few air draft restrictions.

2.2.2.3 Excluded Areas

The areas restricted by military use, marine sanctuaries, and other uses were considered during HMM’s review however the scale at which the study was conducted did not allow for detailed inclusion of specific zones. An example of exclusion zones are shown as red areas in Figure 2-5. Additional areas not shown on the map, such as marine sanctuaries, are assumed to be excluded from potential BOEM lease areas for submerged lands.

2.2.3 Metocean Conditions

Safe environmental conditions during transit, assembly, installation procedures, and maintenance have been evaluated for this study. Metocean conditions used for this evaluation were sourced from National Oceanic and Atmospheric Administration’s (NOAA) National Data Buoy Center (NDBC). Representative general metocean conditions sourced from NDBC were used to aid in the evaluation of local wind, wave and ocean current conditions, though port specific conditions may vary. Based on data collected from NDBC, a preliminary database of typical annual and seasonal wave conditions for the West Coast and Hawaii has been developed. Example wave climate information to be utilized in the study is shown in Figure 2-6 (Example data from NOAA Port Orford buoy).

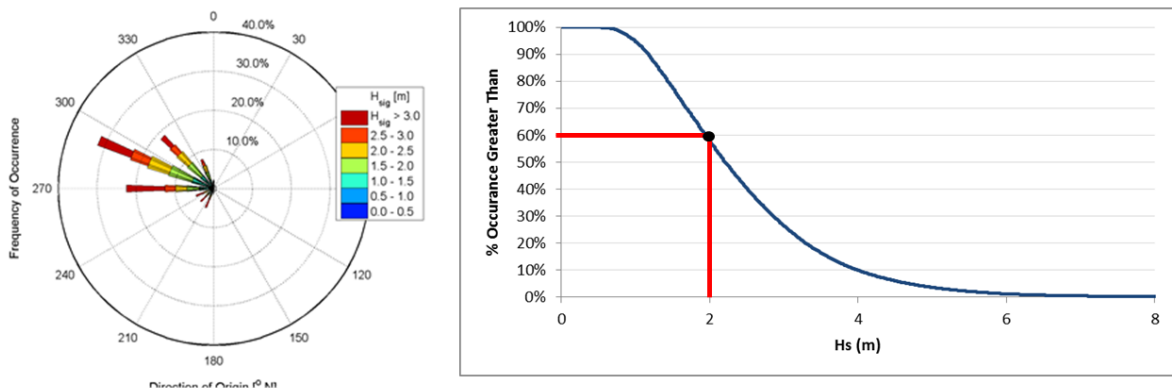

Figure 2-6. Example wave rose and wave height exceedance information
To be utilized in the study (example location – Port Orford, Central Oregon).

The data in this example consist of a wave rose (frequencies of occurrence of certain wave heights by direction, at left) and cumulative distribution of wave height occurrence (right). In this example, approximately 60 percent of all the data recorded a significant wave height of 2 meters or greater. This type of information has been collected for the California, Oregon, Washington, and Hawaiian coasts.

Wind and wave conditions are an important consideration to determine if the metocean conditions may preclude or necessitate the use of certain marine infrastructure at sea. For example, the derrick barge initially used for installation of jackets at the Block Island Wind Farm in Rhode Island could not operate in the wave conditions encountered at site, and a jack-up barge was required to be mobilized.

Metocean conditions have been used to evaluate operational limits of vessels for the following energy system development items:

- Component transport
- Installation
- Assembly
- Operations and Maintenance

The study findings of the metocean conditions are given in Section 3.3.

2.2.4 Jones Act

To access and construct OFW and/or MHK device farms, vessels will be required to transport material from support ports. The Jones Act regulates the transport of merchandise between points in the U.S., and requires the use of U.S.-built vessels owned and operated by U.S. citizens for the transportation of merchandise by water between these points (Douglas-Westwood 2014).

The OCS Lands Act indicates that points under BOEM jurisdiction include anything that is permanently or temporarily attached to the seabed on the outer U.S. Continental Shelf (Papavizas). This would include fixed foundation offshore wind turbines and any barges that use temporary piles (spuds) to affix themselves to the sea floor. The first fixed foundation offshore wind-farm in the U.S. received an exception to the Jones Act to allow a European flagged specialty wind-farm installation barge to be used in construction, since such vessels were not yet available in the U.S. The exception was based on the use of feeder barges taking components from a shore based harbor to the jack-up vessel, however, the project could potentially use the jack-up vessel to transport components from the European Union (E.U.) and deliver them directly to the site for installation.

Floating windfarms will be installed in waters that are too deep to utilize spud barges which attach to the seafloor. The Jones Act does not presently preclude foreign vessels from accessing OFW farms or MHK farms which are not attached to the seafloor. This could potentially allow a foreign vessel to access the site. However, it is possible that the Jones Act may be modified to include OFW or MHK construction. For the purposes of this study it is assumed that all vessels involved in the commercial-scale construction and maintenance of OFW and MHK energy production farms will be subject to the Jones Act.

2.3 Evaluation Criteria

Evaluation criteria have been developed to aid in determining which port facilities meet the expected infrastructure requirements for future energy facility production and installation. Evaluation criteria are organized into several categories: Ports Functions, Supply Chain Logistics, Vessels, and Assembly and Installation Criteria

2.3.1 Port Functions

The study considers pre-installation, installation and operation phases in the life cycle of an offshore renewable energy farm. Development of commercial-scale OFW and MHK requires a range of functions and activities to be conducted at marine facilities. The functions and activities would ideally occur primarily at a single Cluster Port which would provide facilities for fabrication, construction, staging, and assembly. Cluster Ports typically provide support to more than one windfarm and may have a significant number of purpose built facilities for catering to the requirements of each development phase. The different project phases and functions may also be provided across a Port Network, utilizing strengths among different ports. Demonstration-scale and early development OFW and MHK projects may utilize

the Port Network framework rather than rely on development of a Cluster Port. Ports in the Port Network can be classified based on the functions they provide and include:

- Quick Reaction Port (QRP)
- Fabrication and Construction Port (FCP)
- Assembly Port (AP)

Table 2-6 describes potential functions that each of these ports may provide. These functions are intended to generalize the scale of operations and infrastructure required for each port classification. A Cluster Port would incorporate features from each of these classifications.

Table 2-6. Port classification functions

Port Functions		
QRP	FCP	AP
<ul style="list-style-type: none"> • Crew Transfer • Minor maintenance and repairs • Operations homeport • Homeport for pre-installation surveys (bathymetric, benthic) 	<ul style="list-style-type: none"> • Construction, staging, and pre-assembly of device components • Transport hub for device components and materials • Fabrication of nacelle, blade, foundation, cable, generator, hub, cable 	<ul style="list-style-type: none"> • Support final assembly of OFW and MHK devices • Provide staging and storage areas • Marine tow to installation location • Potential cable-laying and mooring installation and monitoring base

Fabrication of components may or may not take place at the FCP facility. This fabrication may occur far from the assembly port, similar to the floating platforms built for the oil and gas industry. In some cases the floating foundations may be built internationally and towed to the Gulf of Mexico where the production unit is assembled on top of the floating foundation at an AP or at the installation site. Wind turbine blades, tower pieces, and nacelles typically may use specialized purpose-built fabrication facilities as well. Some or all of these components may be fabricated internationally and transported to the AP.

Specific OFW and MHK projects may have project-specific needs that do not exactly match the functions listed in Table 2-6. Infrastructure requirements needed for the port functions in Table 2-6 are analyzed in a later section of this study for each port classification.

The port classes will be utilized as a basis for the evaluation of port infrastructure requirements and will aid in conducting pre-screening of ports. This study will classify ports as meeting one or more classifications as part of a port network. In some cases the port may be classified as potentially supporting multiple port classifications (i.e., Cluster Port). Port classifications differ slightly from fixed-foundation offshore wind farms since much of the fixed-foundation assembly activities take place at sea rather than in a port. Differences between existing fixed-foundation offshore wind and floating offshore wind development are evaluated throughout this study. See Section 3.2 for a brief summary on fixed-foundation systems.

2.3.1.1 Quick Reaction Port (QRP)

QRPs are intended to be the homeport for operations and maintenance vessels. The ports must be close enough to the energy development site to allow vessels to reach the site in less than two hours. Operators

may use the “floating hotel” concept for scheduled maintenance, negating the need for short site access times except when responding to unscheduled maintenance requirements. However, this concept has not yet been deployed in the Pacific and will be subject to further evaluation relative to metocean conditions in the Pacific. In this study, the floating hotel concept is considered, but is not assumed to preclude the need for development of QRPs. The following criteria have been used as the approximate requirements in the screening and evaluation efforts for QRPs.

- Berthing requirements for quick response crew transfer vessels (CTVs) (see Figure 2-7)
 - Facility navigation depth
 - Facility navigation width
 - Facility air draft
 - Number of berths (dependent on number of devices in energy farm, typically one vessel per ~30-40 devices)
- Reachable to energy development site within 2 hours
- Helipad infrastructure



Figure 2-7. Example Crew Transfer Vessel at port (Opus Marine 2013)

2.3.1.2 Fabrication and Construction Port (FCP)

This type of port will be utilized during the Installation or Construction Phase. FCPs may handle device components or serve as a transport hub for overland or marine transport. They may also provide fabrication of turbine or MHK components, or construction of the floating foundation. Staging areas may be required to construct or pre-assemble device components prior to transport to an Assembly Port. Overland transport (road/rail) connections are critical for FCPs in order to handle component delivery for fabrication and construction needs. Final assembly may not be feasible at FCPs due to navigation facility limits (e.g., air draft, channel depth, channel width, etc.). Berth and navigation criteria are determined by the vessels required to access the port. Vessels transporting device components required to access FCPs are assumed to be primarily break bulk carriers of Handymax or Handysize size, though shallower draft barges may be feasible for certain projects as shown in Figure 2-8. Cable-lay vessels may also require access to an FCP port, depending on the location of cable manufacturing. These vessels are of similar size to Handysize bulk carriers. Cable manufacturing may be located outside the project area and is assumed to be conducted at existing fabrication facilities. FCPs may also support large component repairs and

therefore transport of the components to the project site. Early-stage projects will likely import turbine components from Europe until existing facilities are upgraded or new facilities are constructed to meet fabrication requirements. The following criteria have been used as minimum requirements in the screening and evaluation efforts of FCPs:

- Navigation channel geometry
- Navigation channel air draft
- Berth length
- Number of berths
- Quayside bearing capacity
- Crane (lift) requirements
- Class of rail access
- Quayside rail access
- Upland laydown and use area
- Dry dock facilities
- Large component (e.g. blade, nacelle, hub, cable) manufacturing facility proximity
- Skilled labor



Figure 2-8. Example of Constructed Component Transport (Renewable Energy Focus 2009)

2.3.1.3 Assembly Port (AP)

This type of port will be utilized during final assembly of the entire devices for marine tow out to the installation location. Navigation and berth restrictions for a fully assembled device follow the geometries outlined in Table 2-1, Table 2-2, and Table 2-5. Direct access to a high capacity deep water dock is required. Marine navigation access to the energy development site from the AP should be deep draft, and in the case of OFW not have any air draft restrictions. APs will likely be located as near as possible to the installation site.

The following criteria have been used in the screening and evaluation efforts as the minimum

- Navigation channel depth
- Navigation channel width
- Navigation channel air draft
- Berth length
- Upland area for storage, staging, and assembly
- Dry dock requirements
- Direct access to high load bearing deep water dock
- Quayside bearing capacity
- Upland laydown and use area
- Skilled labor
- Number of berths
- Distance to installation

Some ports may meet the requirements for multiple classes. The pre-screening analysis and detailed evaluation criteria used the port classification system described above. This system was intended to organize the types of port facilities requirements, organize the port database, and identify the activities Pacific West Coast and Hawaiian ports are able to support.

2.3.1.4 Cluster Port

Cluster ports are evaluated in accordance with the criteria listed above for QRPs, FCPs, and APs. Some efficiency in storage and staging land requirements may be achieved by co-locating fabrication and assembly. An example cluster port (Bremerhaven) is shown in Figure 2-9. Example offshore wind (fixed foundation) Cluster Port



Figure 2-9. Example offshore wind (fixed foundation) Cluster Port in Bremerhaven, Germany (Eurogate 2015)

2.3.2 Supply Chain Logistics

Details of the commercial ocean renewable energy supply chain will help drive the port infrastructure requirements for the industry. As shown by the map in Figure 2-2, wind farm components are presently manufactured across the continental United States. The different OFW and MHK device components will have different transport requirements and modes. Some device components (such as electrical) may be able to be transported overland via rail or road, but the economic feasibility is dependent on the geometry of the component and location of the manufacturing facility. A map of the continental North America Class 1 rail network is shown in Figure 2-10, and the project area is shown in yellow. The figure shows limited Class 1 rail connections on the coast between the Puget Sound and San Francisco Bay. Raw materials or fabricated components may be transported via this network.

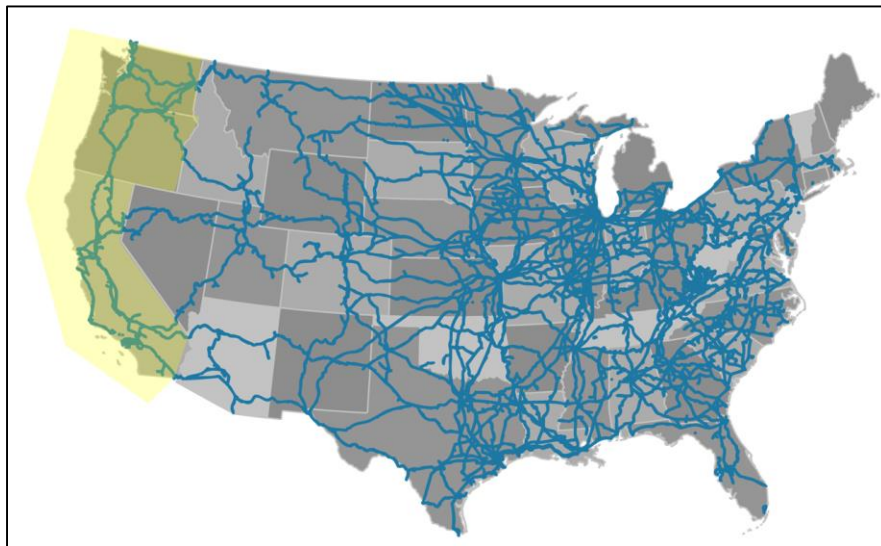

Figure 2-10. U.S. Class 1 railroads (Freight Rail Works 2010)
Project area displayed in yellow.

Oversize components may be subject to geometry restrictions during overland rail and road transport. If transported via rail, the maximum cargo geometry will be dependent on the available rail line classification. Transport by truck will have similar restrictions on geometry, and variable state-by-state oversize transport regulations. Additionally, many OFW and MHK developers are based outside the U.S. and may require marine transport on barges or bulk carriers. Additional details of limitations of road and rail transport are located in Appendix F.

HMM has evaluated the following criteria as they relate to commercial development of OFW and MHK farms:

- Rail Transport
 - Classification
 - Geometric limitations
- Road Transport
 - Classifications

- Oversize Load Regulations
- Marine Transport
 - Classification
- OFW component transport vessel characteristics
- MHK component transport vessel characteristics
- Geometric limitations
- Navigation channel depth, width, air draft

2.3.3 Vessels

The study-specific vessel fleet required for OFW and MHK commercial development services and activities is assessed. Exact vessel type and class requirements will likely differ between MHK and OFW, as well as for different technology types within each (i.e., Spar vs. Semi-Sub). Developers always do motion/acceleration analysis during ocean tows to determine impact, if any, on usage of fatigue life of the components. The vessels can be categorized by the following stages and activities:

- Pre-Installation
- Marine surveying
- Geotechnical surveying
- Assembly/Transport
- Power cable laying
- Anchor and mooring system deployment
- Delivery of device components to assembly port (Figure 2-11. Example wind turbine component delivery vessel (AAL Shipping 2015))
- Device assembly support
- Device tow out
- Device installation
- Dive support
- Maintenance/Operations
- Turbine maintenance
- Inspection and repair of shore and array power cables
- Mooring inspection and maintenance

Based on the above activities, the study will define the size, type, class and number of vessels required for each project stage. Ideally, vessels will be optimized (as they are in Europe) to provide multiple functions to reduce cost. Operation of these vessels will be dependent on industry criteria for safe operations within the environment they are working. For each vessel required the following criteria will be evaluated:

- Vessel geometry – Draft, length overall (LOA), Beam, Air Draft
- Bunkering requirements

- Certification for open ocean operations
- Availability
- Marine construction equipment
- Metocean requirements
- Deployment depth
- Offshore distance limits



Figure 2-11. Example wind turbine component delivery vessel (AAL Shipping 2015)

2.3.4 Assembly and Installation

Assembly and installation criteria of the energy farms are integral to the development and evaluation of vessel and port infrastructure requirements. The following criteria were developed to identify restrictions on activities such as wind limits during installation, crane lift requirements, and live load requirements on wharfs. An example gantry crane used for component maneuvering is shown in Figure 2-12.

Findings related to these criteria may preclude certain construction activities such as assembly at sea. Substation construction is assumed to be either located on-land or located at sea as a specialty operation utilizing existing global resources. The following criteria for assembly and installation will be evaluated:

- Assembly/Transport Requirements
 - Quayside crane requirements
 - Quayside bearing capacity requirements
 - Dry dock requirements/availability
 - Metocean restrictions
- Installation Requirements

- Lift Requirements
- Height/reach
- Mass
 - Land based crane operation
- Operational wind limits
 - Floating crane operation
- Operational wind, current, wave limits
- Other
 - Support equipment
 - Cable laying
 - Mooring/Anchoring
 - Assembly/Installation procedure (i.e., manufacturing port directly to installation location, or staging at AP)



Figure 2-12. Example offshore wind staging area with land-based crane >300 ft. in height (Harland and Wolff 2010)

3. Assessment of Vessel Requirements to Support Offshore Floating Wind and Marine Hydrokinetic Technology on the Pacific West Coast

3.1 Introduction

In this chapter, vessel requirements necessary to support the offshore renewable industry are described relative to the criteria developed in Chapter 2. The vessels estimated to be required to support the development of offshore floating wind (OFW) and marine hydrokinetics (MHK) are based in part on a review of the existing OFW and MHK projects, the highly developed fixed-foundation offshore wind industry in Europe, and the Oil and Gas industry in the U.S. In addition to identifying vessel requirements the findings presented in this memo will be utilized for:

- Determining the port facility and navigation infrastructure needed to support the required vessel fleet.
- Determining the availability of the required vessel fleet in the study region

Vessel requirements were developed based on discussions with marine contractors and vessel captains, literature review, and review of prototype industries. Because the OFW and MHK industries are in a nascent stage of development, assumptions regarding transport needs were required, and are outlined in this chapter. Because existing industries for OFW and MHK technology are not developed, analyses of industries with similar marine requirements were conducted and used as prototypes. The prototype analyses for identifying vessel requirements include fixed foundation offshore windfarms, demonstration-scale projects, and floating production units (FPUs) in the oil and gas industry.

3.2 Prototype Analysis

3.2.1 Existing Industry Prototypes

An analysis of existing industries with similar supply and installation requirements as the OFW and MHK technologies has been conducted. These similar industries have been labeled prototypes for the purposes of this study. Globally, installations of full-size OFW and MHK devices have been limited to demonstration-scale projects, which typically include a single device rather than the 30 or more devices likely required for a commercial farm. These demonstration projects have also been reviewed as part of this study as many of the installation requirements are similar.

The offshore wind industry in Europe is presently highly developed for fixed-foundation turbines (i.e., those with structures attached to the seafloor). In the U.S., one demonstration offshore wind farm is currently under construction, and consists of five turbines supported by fixed-foundation jacket structures. Many of the vessels required for installation and operations/maintenance of fixed-foundation offshore wind will also be required for floating offshore wind, though not all due to the differences in installation methods.

The oil and gas industry is highly developed in the U.S. and utilizes large-scale floating structures for production of oil and gas at sea where depths do not allow for fixed-foundation structures. Many of the same floating foundation technologies proposed for OFW are currently installed and used in the Oil and Gas industries.

Vessel use examples from fixed-foundation offshore wind industry, MHK, and OFW demonstration projects, and the Oil and Gas industry will be used as prototypes in this study and are described in the following sections.

3.2.1.1 Offshore Wind – Fixed Foundation

The offshore wind industry in Europe is highly developed with approximately 2500 turbines installed (Grington *et al.* 2015). The average depth of the fixed foundation turbines is approximately 75 feet, compared to depths on the order of 1000 feet for some of the initial commercial-scale floating wind project applications (i.e., WindFloat). Construction of the first U.S. based fixed foundation offshore windfarm (5 devices) began in 2015 off Block Island, Rhode Island. Example project phases for fixed-foundation projects are shown in Figure 3-1 and includes pre-installation, installation, and operations/maintenance activities (sourced from the United Kingdom’s Crown Estate).

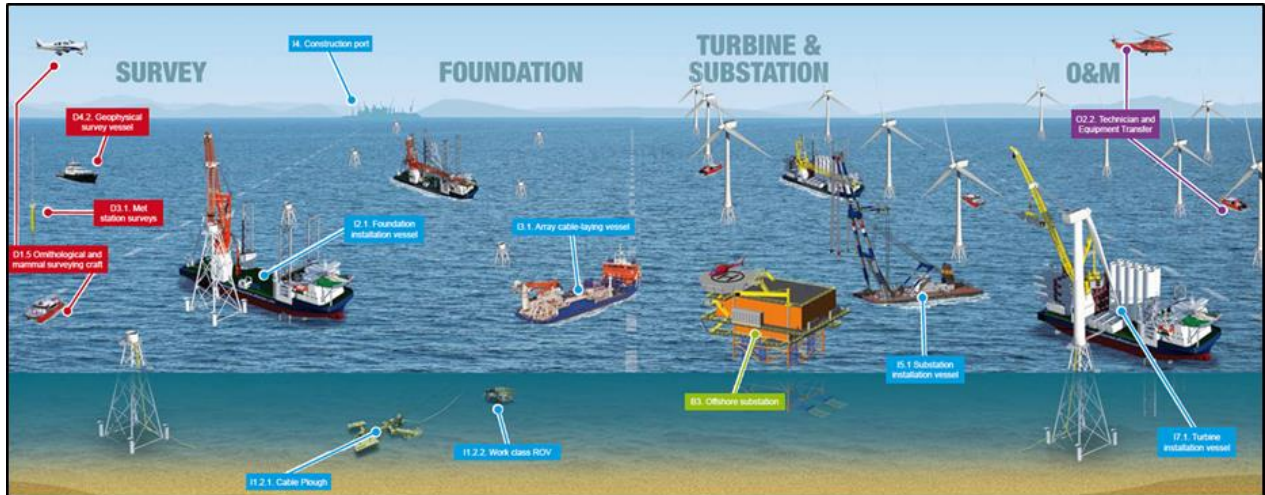

Figure 3-1. Typical vessel activities for fixed foundation offshore wind turbine energy farms (The Crown Estate (U.K.) 2016)

While not all activities shown in this figure may apply to floating offshore wind and MHK, certain activities are common to any offshore renewable energy installation. The common activities include:

- Pre-installation surveys (bathymetric, benthic, geotechnical, metocean);
- Component transport;
- Shore-power and array-power cable laying;
- ROV assistance; and
- Technician and Equipment Transfer

Because the device is floating rather than fixed, several significant differences in installation procedures will exist. OFW does not require any installation of a fixed foundation to the seafloor, and therefore will not require a foundation installation vessel such as a crane barge (Figure 3-2). It is anticipated, based on review of OFW developer concepts, that the wind turbines will be affixed to the floating foundation at an assembly port. However, depending on the exact technology available, some OFW devices may be able to be assembled in a protected harbor using floating or jack-up crane barges similar to fixed foundation technology, so these vessels are still included in this evaluation. Assembly and/or installation of OFW and MHK energy farms are dependent on metocean environment in the Pacific and the availability of such vessels on the Pacific West Coast and Hawaii. Environmental limits for the specific vessel types are shown in Table 3-1, as available.

Table 3-1 also outlines example vessels used for the activities listed above. Vessels in this table are intended to be indicative of the vessels currently in use in the fixed foundation offshore wind industry. Environmental limits are based on discussions with marine contractors and shipping companies (Foss, Crowley, Orion, Manson, Weeks, Global Marine, and Advanced American Construction), ports and literature review. The limiting sea state for marine equipment is a function of both wave height and wave period. Longer period waves (greater than 11 seconds), such as those found in the Pacific, have a greater effect on the operating window than shorter waves. Longer wave periods cause more vessel motion for the same wave height, therefore reducing the limiting wave height for operation.

Table 3-1. Example vessels required for fixed foundation activities

Vessel	Activity	Prototype Vessel	LOA (Ft.)	Beam (Ft.)	Draft (Ft.)	Max. Depth (Ft.)	Environmental Limit ¹ (Hs, Wind)
Cable Laying Vessel	Shore and Array Cable Install	C.S Sovereign	429	69	23	-	Hs <6-10 ft. ² Wind < ~17-27 knots
Cable Laying Barge	Shore and Array Cable Install	Networker	197	67.3	8.6	-	~6 ft. for 6 second wave period.
Ocean Class Tug (~150 ton Bollard Pull)	Barge and Device Transport	Crowley Ocean Wind	150	46	21	-	N/A
Anchor Handling Tug (120 ton bollard)	Anchor and Mooring Deployment	Maersk Chignecto	220	52	20	-	N/A
Anchor Handling Tug (275 ton bollard)	Anchor and Mooring Deployment	Mærsk Attender	300	75	25	-	N/A
Multi-Purpose Vessel	ROV support and Anchoring, Mooring	Fugro Symphony	428	79	24.6	-	Hs < 3-5 ft.
Jack Up Barge	Assembly, Installation of Turbine at Sea	J/U Wind	181	60	10	150	Hs < 4 ft.
Jack Up Vessel (with >500 ton crane)	In-water Assembly, Installation	Fred Olson Wind Carrier	430	125	N/A	~140	N/A
Floating Crane - 500 ton	In-water Assembly, Installation	Weeks 531	420	90	8	-	4-5 ft., @ Tp <11 seconds
Floating Crane – 700 ton	In-water Assembly, Installation	General	300	100	260	400-500	Wind<34 knots
Floating Crane – 1000 ton	In-water Assembly, Installation	Manson E.P. Paup	380	105	10	-	Hs < 4 ft. Wind < 30 knots.
Floating Crane (1000+ ton)	Substructure and Substation Installation	Rambiz 3000	275	150	10	-	N/A
Bulk Carrier	Blade and turbine	BBC. Maine	330-	66-75	21-32	-	N/A

Vessel	Activity	Prototype Vessel	LOA (Ft.)	Beam (Ft.)	Draft (Ft.)	Max. Depth (Ft.)	Environmental Limit ¹ (Hs, Wind)
	component transport		470				
Barge	Blade and turbine component transport	Nicon Industries UR96	300	90	16	-	N/A
Crew Transfer Vessel (CTV)	O&M Personnel Transport	TBA	~75	~30	~12	-	~2 m

¹ Crane capacity may be significantly reduced prior to environmental limit due to vessel motion, limiting heavy lift operations. Component assembly may also have tighter restrictions due to the assembly tolerances required.

² Limits depend on activity. Laying cable on seafloor may occur with swell up to 4 m, while trenching requires calmer seas and winds. Hs = significant wave height. Tp = peak wave period.

Not shown is the “mothership” operation and maintenance (O&M) vessel concept, but would service windfarms located a long distance (i.e., greater than ~40 nautical miles [nmi]) from a quick reaction port (QRP), and remain in offshore deep-water wind farms. The vessel would provide a safe haven for catamaran workboats to carry engineers to service turbines (Seasteading 2011). It would also serve as a floating hotel for crew. One example of a floating hotel is the Atlantic Enterprise which can support two catamaran vessels in a “garage” area. These vessels may include a built-in stability system to aid in passenger comfort. Limited information is available, but literature review indicates vessels may be able to remain safely on site in waves up to eight feet (Offshore Ship Designers 2011).

Vessel fleet requirements for these activities are described in Section 4. Estimates of the vessel requirements for these activities was based up on review of the fixed foundation offshore wind industry, discussions with U.S. based marine contractors, and marine surveyors.



Figure 3-2. Floating Crane Barge
Rambiz 3000 installing a wind turbine (Wind Energy The Facts, 2016).

3.2.2 Demonstration-Scale OFW and MHK

The global floating wind and MHK industries are in a nascent stage of development, similar to the conditions in the U.S. The European Marine Energy Centre (EMEC) is located in the Orkney Islands in the U.K. and provides a grid connected testing site for MHK devices such as the Pelamis device. Several other MHK devices are grid connected throughout the world, but not on a commercial-scale (i.e., greater than five devices).

Vessel requirements for the installation of demonstration-scale OFW and MHK devices were reviewed for inclusion into this study. Requirements universal to the construction of an offshore energy farm are discussed in Section 3.2.1.1. The demonstration projects reviewed in this study are limited and include only deployments of full-scale (or near full-scale) units deployed in deep water (i.e., not scaled down devices deployed in water depths greater than 150 ft.). It is important to note that though the size of the demonstration-scale OFW projects are on a similar order of magnitude to the proposed commercial projects, the numbers of the turbines and in some cases the size of the turbines (i.e., 2 megawatt [MW] vs. 6 MW) in the OFW demonstration projects are smaller than proposed for commercial use. Example OFW and MHK projects are described in the sections that follow.

3.2.2.1 OFW Example Projects

Semi-Sub Example

The company Principle Power deployed and installed a semi-sub supported, 2 MW wind turbine device as a demonstration 5 km off the coast of Portugal in 2011, in approximately 150 ft. of water depth. Fabrication and assembly were completed in two separate onshore sites (metal fabrication facility and Lisnave shipyard). The assembled device was then floated out to sea through the navigation channel using a system to add buoyancy, and decrease draft requirements. The device was towed 225 nmi from the installation location by a single anchor handling tug (AHT) vessel. Installation required the AHT and three support tugs. The same AHT vessel also installed the anchors and mooring system at the final location. Images from the installation are shown in Figure 3-3.



Figure 3-3. Semi-Sub demonstration project installation (WindFloat, 2014)

Spar Example

Statoil Hywind installed one spar-supported 2.3 MW wind turbine device as a demonstration off the coast of Norway in 2009 in 650 ft. of water. The spar device was fabricated in Finland and towed 900 nmi to Norway in a horizontal orientation, as shown in the top left panel of Figure 3-4 by two ocean tugs. The

spar was upended in semi-protected deep water (Åmøyfjorden, 400-ft. depth) using three tugs, with at least one having the capability to prepare the mooring chains via crane. Once upended and ballasted, the tower and rotor components were delivered to the floating assembly site via multi-purpose vessel (MPV). A floating crane was on site to install the components, with an additional moored barge providing stability during installation. The assembled turbine/spar system was towed upright to the final installation location by multi-purpose vessel (Normand Pioneer), and two assist tugs. The MPV hooked the spar up to the pre-installed mooring system.



Figure 3-4. Spar demonstration project installation example (Hywind 2015)

TLP Example

No commercial-scale offshore wind turbines supported by tension-leg platform (TLP) technology have yet been deployed at full-size scale, to the knowledge of Hatch Mott MacDonald (HMM). GICON, based in Germany, is planning a 2.3 MW Floating Offshore Foundation (GICON-SOF), a TLP, to be deployed in the Baltic Sea in 2016, and it is currently under construction. The commercial version of this specific device has a self-installing foundation, which is lowered to the seafloor once the entire assembled unit is towed to site. Construction of the demonstration will occur at Stralsund, Germany and assembly will occur at Sassnitz, Germany as depicted in Figure 3-5. The device will be towed to site by four ocean tugs, according to a GICON installation video. A spud barge appears to be proposed to be onsite for installation and ROV support.

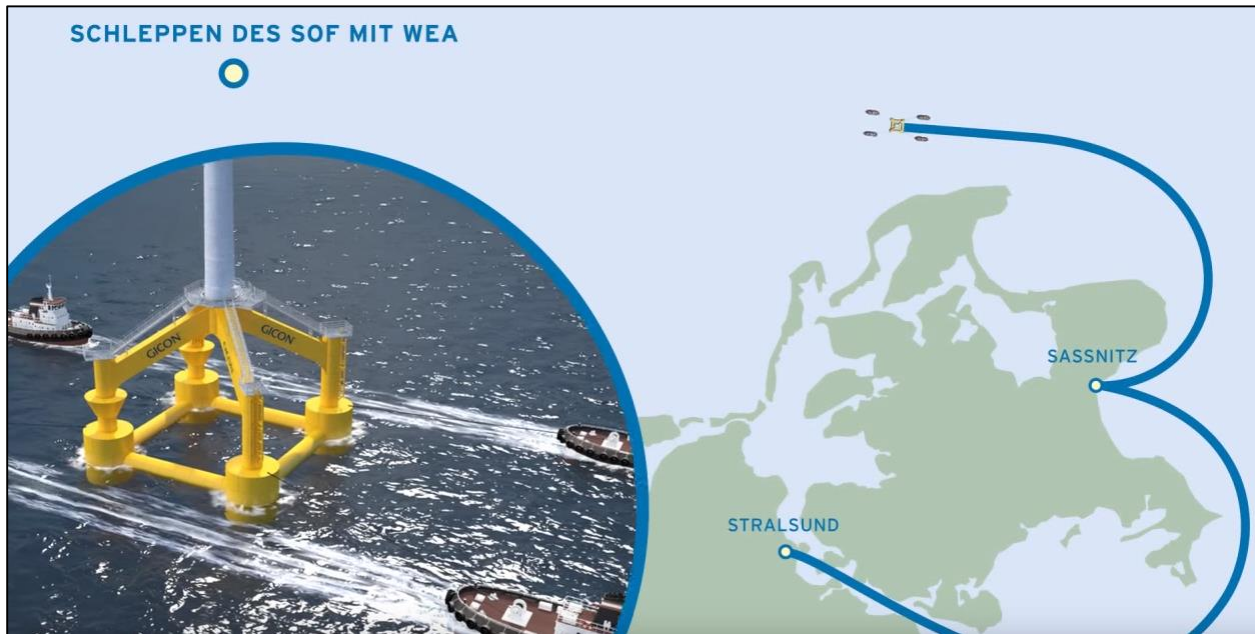

Figure 3-5. GICON-SOF TLP installation concept (GICON-SOF 2016)

OFW Installation Summary

A summary of vessels related to installation of the OFW demonstration-scale devices is shown in Table 3-2. These do not include vessels required for cable laying and other activities typically required for ocean energy farms such as those described in Section 2.1.1. Instead this table highlights technology specific needs.

Table 3-2. Summary of Example Installation Vessels for OFW Demonstration Projects.

Technology	Device	Country	Deployment Year	Installation Vessels
OFW – Semi-Sub	Principle Power - WindFloat	Portugal	2011	AHT, 3 support tugs
OFW - Spar	Statoil – Hywind	Norway	2009	Ocean tug, 2 crane barges, MPV, Anchor-handling Supply Vessel Tug, 2 assist tugs
OFW - TLP	GICON-SOF	Germany	2016	4 ocean tugs

3.2.2.2 MHK Example Projects

Pelamis and Wello Wave Energy Conversion (WEC) Devices

The European Marine Energy Center, located in the Orkney Islands, U.K. provides testing facilities for MHK devices, and includes a shore connected power cable. The shore connected cable was installed using a typical cable laying vessel (C.S. Sovereign). Two wave energy conversion (WEC) devices, the Pelamis and Wello Penguin, installed here have been reviewed for inclusion into this study, and are shown in Figure 3-6 and Figure 3-7.

The Pelamis was fabricated near the quayside, and loaded into the water via crane. Once in the harbor's water it was assembled and towed to the installation site at EMEC for installation to the pre-installed mooring system as shown in Figure 3-6. Installation appears to have been conducted by two multicat tugs. Outside of EMEC, three Pelamis devices were installed in Portugal after fabrication and transport from the U.K. The devices were transported upon an MPV for final assembly and tow-out in Portugal, the 300 ft. length overall (LOA) vessel M/V Sea Power. The Wello device was also installed using multicat tugs as shown in Figure 3-7. Multicat tugs typically have a bollard pull capability of approximately 30 tons, and are outfitted with one or two cranes rated at 15-30 tons. Availability of multcats are limited in the project study area.



Figure 3-6. Example Multicat Vessel at a Pelamis device (Delta Marine 2013)



Figure 3-7. Wello Penguin Installation at EMEC by two multicat tugs (CEFOW 2015)

Table 3-3. Select Demonstration-scale MHK Device Installations.

Technology	Device	Location	Deployment Year	Installation Vessels
MHK – Wave Attenuator	Scottish Power Renewables - Pelamis	Scotland	2012	2 Multicat tugs. MPV for long-haul device transport.
MHK -	Wello - Penguin	Scotland	2012	2 Multicat tugs

3.2.2.3 Literature Review

HMM included a 2012 study conducted by Slevin *et al.* as part of the literature review for this report. The study includes interviews with several offshore WEC developers to determine vessel requirements for installation. Their findings are summarized in Table 3-4 and are similar to observed vessels listed in

Table 3-4. WEC Vessel Requirements (summarized from Slevin *et al.* 2012)

Developer	Mooring Installation Vessel	WEC Installation Vessel	Operations and Maintenance	Developer
Wavebob	AHT	Custom catamaran barge with 100 ton winch and crane. 2 support tugs	Tugboat with crane. Rigid inflatable for routine maintenance.	Wavebob
Pelamis	AHT	Multicat Tug, 30 ton bollard pull	Multicat Tug, 30 ton bollard pull	Pelamis
Ocean Energy	AHT	Tugboat and service boat	Tugboat and service boat	Ocean Energy

Martinis (2015) identified the wind and wave access limits for WEC maintenance as approximately 5-6.5 ft. and 15-20 knots. Operating limits in the field will depend on the selected maintenance vessels, but some repairs may require towing into port to conduct the required maintenance.

Oregon State University has been conducting benthic habitat surveys at an MHK test site off the coast of Oregon, utilizing the vessel R/V Oceanus and the R/V Elakha. These vessels can be used as prototypes for potential benthic habitat survey requirements in future projects. Both are stationed in Newport, Oregon at the Hatfield Marine Science Center. Typically, benthic and other environmental surveys are conducted prior to environmental project approval and do not require specialized vessels.

3.2.2.4 MHK Summary

Based on this review of MHK existing projects, it appears that demonstration-scale MHK devices have typically utilized one or more tugboats, one of which may be outfitted with a crane (such as a multicat tug), for transport to the installation site from the assembly port, and installation of the device. Long distance transport of the devices appear to have been completed by towing the device in the water, placement of the device on a barge, or with the device as breakbulk cargo on a large (>300 ft.) vessel. The transport method of choice for each project may differ, and is subject to economic constraints. An example of port-to-port MHK transport is the 2007 transport of three Pelamis devices from Scotland to Portugal. In general, MHK devices have required less significant vessel infrastructure than OFW.

OFW and MHK Demonstration Project Summary

Based on review of the noted, existing OFW demonstration projects, it appears that AHTS and additional support tugs were required for transport of the assembled devices. A summary of observed demonstration-scale installation vessels is shown in Table 3-5.

Table 3-5. Vessel dimensions.

Vessel	Tech.	Prototype	LOA (Ft.)	Beam (Ft.)
AHTS (80 ton)	OFW	Bourbon Liberty 200 Class	200	50
Multi-Operation Service Vessel	OFW	Normand Pioneer	300	78
Assist Tug (~70ton Bollard)	OFW	Bourbon Kianda	105	40
Ocean Support Tug (110 ton Bollard)	OFW	Crowley Ocean Wind	150	46
Crane Barge (200 ton capacity)	OFW, MHK	Work Barge	130	50
Multicat Tug	MHK	Delta Marine Voe Viking	98	41
Harbor Support Tug (65 ton)	MHK	Signet Enterprise	105	34
Benthic Habitat Survey	OFW, MHK	R/V <i>Oceanus</i> Sea Otter	54-177	16-33

3.2.3 Oil and Gas Industry – Floating Structures

The U.S. Oil and Gas industry utilizes large floating production units (FPU) for operations in deep waters such as in the Gulf of Mexico. This industry has been operating in deep waters for over 60 years (3U Technologies 2009) and has significant marine assets. Because there are similarities in technology and scale, the distance from shore vessel requirements for this industry are considered as an additional prototype in this study. Similar to OFW, FPUs utilize Semi-Sub, Spar, and TLP floating structure technology which in the U.S. are deployed throughout the Gulf of Mexico and Alaska. MHK devices are typically of smaller scale and utilize different floatation technology therefore FPUs are not assumed to serve as a prototype example.

Example dimensions of Semi-Sub, TLP, and Spar devices used for FPUs are shown in comparison to similar OFW technology in Table 3-6. Sizes are approximate and are intended only to provide an order of magnitude comparison. Based on this comparison, OFW structures are estimated to be smaller than some of the largest FPUs currently installed worldwide.

Table 3-6. Prototype oil and gas floating structures compared to OFW foundations

Foundation	Length/Width (Ft.)	Transit Draft (Ft.)	Displacement (Tons)	Foundation
Oil and Gas				
Semi-Sub Unit	400 x 292	30	~46,000	Semi-Sub Unit
Spar Unit	110 Diameter, 605 Length	~30	~23,000	Spar Unit
TLP Unit	~250 X 250	N/A	~55,000	TLP Unit
OFW				
Semi-Sub OFW	~160 x 160	~30-35	~8,000	Semi-Sub OFW
Spar OFW	~30 Diameter, ~300 Length	~30-250	~15,000	Spar OFW
TLP OFW	~160 x 160	~30	~8,000	TLP OFW

Information on typical FPU installation and transport was collected from literature review and discussion with marine contractors. Figure 3-8 shows transport of two different types of FPU’s in the Gulf of Mexico utilizing two ocean tugs. Figure 3-9 shows installation of an FPU utilizing several tugs in a star formation.



Figure 3-8. Spar (left panel) and Semi-Sub (right panel) towed by two Crowley Ocean Tugs (150-ton bollard pull each), with a support tug as auxiliary (Crowley 2013)

The wave climate in the Gulf of Mexico is much different from the Pacific West Coast, the typically calmer seas allows for additional installation support from floating cranes. In some cases, the FPU foundation is towed to site and installed, and then a floating crane may install the rig platform on top of the floating foundation (see Figure 3-10). A summary of the information collected on FPU installation procedures is presented in Table 3-7 and is intended to be representative of a fleet that may be used for the towing and installation of FPUs.

Table 3-7. Prototype fleet required for FPU transport and installation

Vessel	Activity	Prototype	LOA (Ft.)	Beam (Ft.)
AHT (200 ton Bollard)	Lead tug	M/V Aiviq, Tor Viking II	275-360	60-75
Assist Tug (~45-80 ton Bollard)	Assist tug	Garth Foss, Daniel Foss	95-155	32'46
Ocean Tug (150 ton Bollard)	Dual lead tugs	Crowley Ocean Wind	150	46
MPV	Geotechnical, subsea inspection, ROV support	Fugro Symphony	428	79
Floating Crane (1000 ton)	Rig Platform Installation	E.P. Paup	380	105
Floating Crane (3000 ton)	Rig Platform Installation	Rambiz 3000	275	150



Figure 3-9. Installation of Semi-Sub FPU utilizing tugs in star formation (Crowley 2014)



Figure 3-10. Floating cranes, Manson 1000 ton E.P. Paup (Manson, 2015)

3.3 Metocean Environment Considerations

3.3.1 Metocean Conditions

Use of the vessels identified in the prototype analysis may be constrained by environmental operating limits. Vessel operating limits were identified in the tables in Section 2.1. A database of typical wind and wave conditions for the Pacific West Coast and Hawaii was generated to cross-reference with typical limiting operation conditions of vessels identified in Section 2. Generalized Southern and Northern Hawaii sea states are parameterized by the two buoys included in the summary. A summary of typical wind and wave conditions in this database is shown in Table 3-8.

Table 3-8. Metocean database summary

Parameter	Southern CA	Northern CA	OR	WA	Southern HI	Northern HI
Min Deployment Depth	~200 ft.	~200 ft.	~200 ft.	~200 ft.	~200 ft.	~200 ft.
Ave Wind Speed	~13 mph	~13 mph	~14 mph	~14 mph	~18 mph	~15 mph
Ave. Significant Wave Height (Hs)	~6.5 ft.	~7.5 ft.	~7.5 ft.	~8 ft.	~8 ft.	~7.5 ft.
Ave. Peak Wave Period (Tp)	11.6 sec	11.4 sec	10.8 sec	11.1 sec	10.1 sec	10.9 sec
Ave. Summer ¹ Wind Speed	~13 mph	~11 mph	~12 mph	~12 mph	~18 mph	~14 mph
Ave. Summer Hs	~5.5 ft.	~6 ft.	~5.5 ft.	~6 ft.	~7 ft.	~6 ft.
Ave. Summer Tp	10.3 sec	9.9 sec	9.4 sec	9.9 sec	9.1 sec	9.6 sec
Ave. Winter ² Wind Speed	~13 mph	~15 mph	~15 mph	~15 mph	~18 mph	~15 mph
Ave. Winter Hs	~7.3 ft.	~9.3 ft.	~9.0 ft.	~9.3 ft.	~9 ft.	~8 ft.
Ave. Winter Tp	12.5 sec	12.4 sec	11.8 sec	12.0 sec	10.9 sec	11.7 sec
NOAA Buoy #	46011	46022	46050	46029	51002	51001

¹ May – September

² October - April

A comparative analysis of metocean conditions was conducted relative to operation restrictions of potential vessels to be used for OFW and MHK installation, and is shown in Table 3-9. In this table, a green “+” symbol indicates little to no potential issues with operating at the installation site, a yellow “+/-” symbol indicates potential conflicts with metocean conditions at the installation site, and an orange “-” indicates unfavorable conditions for the vessel at the installation site (i.e. significant downtime) but does not mean that all use is precluded. Not all the vessels in are required for installation of any specific OFW or MHK device. Vessels shown in Table 3-9 are only being analyzed for the potential use relative to installation site conditions and are not intended to be associated with a specific technology.

Table 3-9. Vessel metocean considerations

Vessel Type	Southern CA	Northern CA	OR	WA	HI	Comment
Jack-Up Barge	-	-	-	-	-	Depths preclude use of jack-up spuds at installation sites. Hs < 4 ft. May be considered at intermediary assembly location.
Crane Barge ~500 tons	-	-	-	-	-	Construction requires wave height < ~4-5 ft.
Crane Barge > 500 tons < 1000 tons	-	-	-	-	-	~500' depth max. Long period waves in Pacific may limit lift capacity due to vessel motion.
Crane Barge >=1000 tons	-	-	-	-	-	Construction may require wave height < ~4 ft. Special uses would need to be coordinated with weather window.
Cable Laying Vessel	+	+	+	+	+	Favorable in summer (Ave. wave height < 6 ft.)
Cable Laying Barge	+/-	+/-	+/-	+/-	+/-	Reduced wave height limit for wave periods greater than 6 seconds
Anchor/Mooring Installation	+/-	+/-	+/-	+/-	+/-	Should be coordinated with favorable seas, less than 4 ft.
CTV Mothership	-	-	-	-	-	May support CTVs in offshore environment up to approximately 8-10 ft. wave height. Winter wave climate may preclude long term use.

Not shown in this table is the impact of wind speed limitations during assembly of the turbine blades to the tower. A typical limit on wind speed for assembly of wind turbine blades is approximately 17 mph (Grignon *et al.* 2015). This limiting wind speed is approximately the same as average annual wind speed on the Pacific West Coast and Hawaii, which could result in significant at sea construction downtime due to excessive wind speed.

The use of jack-up barges during installation may have significant downtime based on the metocean conditions present at the installation site relative to their operational limits, and depth limitations (~250 feet). They may however, be used for assembly at an intermediary location, similar to the Hywind Spar demonstration project assembly. Floating crane barges may be used at the installation site, though some equipment is limited by depth since they require moorings, and may also be subject to long periods of downtime. However, it is not likely that large scale installations at sea will utilize floating barges due to the typical wave heights and long wave periods present in the Pacific Ocean (typical annual average wave height ~11 seconds).

Access to a safe harbor will be a requirement for those vessel types that have operational wind and wave limits. Additionally, if vessels are not certified to have living quarters, they will likely need to return to port to exchange crews. In the case that unfavorable wave conditions occur, the vessel must be able to find refuge in a protected harbor. Moored floating barges of this size have been utilized on the Pacific West Coast before for specialized construction (Point Loma Outfall Extension) in depths of 200-300 ft. Smaller crane barges may be utilized for MHK installation, but as with the larger crane barges they must be certified for open ocean use by the American Bureau of Shipping (ABS). Without proper certification, the United States Coast Guard does not allow the vessel to conduct operations in the open ocean.

3.4 Prototype Industry Vessel Applicability and Availability Analysis

Vessels and vessel related activities found during the prototype analysis for fixed foundation offshore wind, demonstration-scale projects, and the oil and gas industry have been evaluated qualitatively for applicability to commercial-scale OFW and MHK as well as availability in the project area. Vessel-by-vessel analysis can be found in Appendix D for each prototype industry. Ocean and coastal tugboats will be required, and are readily available in the project area. Larger required vessels, such as cable laying vessels and anchor handling vessels may not necessarily be available locally because of limited ocean construction in the project area, but may be mobilized from elsewhere in the U.S. Crane barges and large vessels such as MPVs are not necessarily required vessels on their own for OFW and MHK projects, but may be used on a project-to-project basis. Crane barges are available in the project area, but MPVs are limited. Ocean barges and bulk carriers are expected to be available for use, and will be required for transport of components.

3.5 Vessel Infrastructure Requirements

This section presents an overview of a project activity timeline from project start up to operation, and describes the potential fleet database to support OFW and MHK.

3.5.1 Vessel Activity Phases

Because at the time of this study no commercial floating offshore wind farms or MHK farms are in existence, a vessel activities timeline was developed based on our review of the existing practices for fixed foundation offshore windfarms, the operations in the U.S. of the oil and gas industry, and the farm technology specific construction constraints. Potential approximate phases which rely on vessel activities for floating ocean energy projects (both OFW and MHK) are shown in Table 3-10.

Typically, the first activity phase is a series of surveys conducted at the project site to establish baseline conditions for marine mammals, depths, geotechnical conditions, and metocean conditions. It is assumed that after the surveys are conducted, the anchors and mooring system will be installed prior to device arrival. In parallel to the mooring system installation, it is assumed that the power cable to shore and array power cables will be installed. Due to the limitations on construction and assembly at sea in the Pacific, it is expected that devices will be towed to site fully assembled. However, assembly may occur in an intermediary protected deep water location stationed between the port and installation area. Assembly of the generating devices may take several tugs in order to position the device. Once the devices begin generating power, routine maintenance and component replacement support is required. Section 3.2 describes the potential vessel fleet and the required activities assumed in this study.

Table 3-10. Potential vessel activities (OFW and MHK)

Phase	Activity
Pre-Installation (Duration will vary with size of farm)	<ul style="list-style-type: none"> • Baseline Surveys: <ul style="list-style-type: none"> ○ Bathymetric ○ Geotechnical ○ MetOcean ○ Marine Mammals/Birds/Benthic
Assembly/Installation (Duration depends on size of installation)	<ul style="list-style-type: none"> • Anchors and Mooring System Installation • Power Cable Installation • Array Power Cable Installation

Phase	Activity
	<ul style="list-style-type: none"> • Device and Foundation Component Transport • Assembled Device Transport • Installation Support • ROV and Dive Support
Operations/Maintenance	<ul style="list-style-type: none"> • Maintenance Crew Transfer (needs may differ for MHK) • Device Repair • Inspection of shore and array power cables • Inspection of mooring lines • Towing to port for major repairs
Assumptions	<ul style="list-style-type: none"> • OFW and MHK devices likely transported to site fully assembled • Major repairs to floating devices may require towing back to assembly port • Anchors and mooring system will be installed prior to device arrival • Routine maintenance and component replacement will be required during operations

3.5.2 Potential Vessel Fleet Database

Potential vessel fleet requirements for OFW and MHK devices have been developed based on a review of existing offshore wind farms, demonstration-scale ocean energy projects, the oil and gas industry, metocean and depth constraints, and device geometry. In this section, potential vessel requirements are categorized into the following activities:

- Survey
- Subsea work
- Towing/Transport
- Assembly
- Installation
- Maintenance and Operation

The vessels listed in these sections do not necessarily represent all of the vessels or the minimum number of vessels required. Many vessel combinations are possible that could provide the necessary capabilities for an OFW or MHK project. More than one vessel may provide several services, and in some cases vessels shown in each section provide the same function as others in the section. Exact vessel fleet will be dependent on developer technology, vessel availability, economics, timeline requirements, location, proximity to port, and metocean conditions. Additionally, because these industries are in a nascent stage, new vessels may be developed that are specific to the OFW and MHK industries. These potential new vessels are not included herein.

3.5.2.1 Survey

Preliminary estimates for survey activities (bathymetric, geotechnical, metocean) to support OFW and MHK development are described in Table 3-11.

Table 3-11. Survey vessels

Vessel	Activity	Technology	LOA (Ft.)	Beam (Ft.)	Draft (Ft.)	Port
Survey Vessel	Marine Surveying	OFW, MHK	50-231	24-42	7-14.3	QRP
Research Vessel	Marine Mammal/Birds/Benthic Habitat Survey	OFW, MHK	54-177	16-33	5-17.5	QRP

Bathymetric Survey Vessels are typically available along the Pacific West Coast and Hawaii in a range of geometries.

Sub-Sea Work

Sub-sea work vessels are utilized primarily at the installation site, and may or may not be involved in the transport or installation of the devices. These vessels are able to provide specialty services such as ROV and dive support, cable lay, or geotechnical investigation. Preliminary estimates of required vessels for sub-sea work activities to be required to support OFW and MHK development are shown in Table 3-12.

Table 3-12. Sub-sea work vessels

Vessel	Activities	Technology	LOA (Ft.)	Beam (Ft.)	Draft (Ft.)	Port
Cable-Laying Vessel	Shore Cable Laying, Array Cable Laying, Trenching	OFW, MHK	305-425	60-75	21-33	FCP or AP
OCV/MPV	Mooring Installation, Geotechnical Surveying, Meteorological Buoy installation, ROV, Cable Lay	OFW, MHK	200-425	50-80	18-25	FCP or AP

Sub-sea work vessels are specialized equipment, which may not currently be available in the project study area. They are available however, in the global marketplace as “vessels of opportunity” (3U Technologies 2009). A single multi-purpose vessel may be able to provide cable laying, mooring, geotechnical survey, and ROV services given a “Swiss army knife approach.” This approach can provide a more costly option on a per day basis, but it does have advantages. With one primary vessel performing all stages of the installation process, risk of delays due to the coordination and availability of multiple assets is eliminated, minimizing potential for schedule growth. Offshore Construction Vessels (OCV) and MPVs are capable vessels for all types of offshore construction activity, including alternative energy projects. The typical MPV and OCV has a large flat deck area for mobilization of a variety of equipment and other resources depending on job requirements, and a crane, as shown in Figure 3-11. The downside to utilizing an MPV or OCV includes cost & schedule requirements for demobilization and re-mobilization of different deck layouts to perform different stages of the installation process. (3U Technologies 2009).

Divers can be utilized in shallow water areas for inspection and installation services. Generally speaking, diver working depth for this type of work is limited to 75-150 ft. Divers are normally utilized in the near shore cable installation activities such as cable landing services, post lay inspection, and installation of cable protection in environmentally sensitive areas where burial may be prohibited. (3U Technologies 2009).



Figure 3-11. Example of Multi-purpose Vessel - Fugro Symphony (Fugro Symphony 2016)

3.5.2.2 Towing/Transport

Towing and transport vessels are utilized to transport either components of the devices or assembled devices, and may or may not be involved in the assembly and installation of the devices. Preliminary estimates of required vessels for transport activities to be required to support OFW and MHK development are shown in Table 3-13.

Based on discussion with marine contractors, it appears that vessels with bollard pull of 70 tons or greater will likely be required. However, any heavy tow will likely require a marine warranty survey to ensure adequate bollard pull is provided by the towing vessels in order to insure the voyage. The engineering work to complete the warranty is completed by a third party and includes assessment of the metocean environment and checking the resistance calculations. Bulk import cargo, such as nacelle and tower components, may be transported overland to the assembly port.

Table 3-13. Towing and transport vessels

Vessel	Activities	Tech	LOA (Ft.)	Beam (Ft.)	Draft (Ft.)	Port
Bulk Carrier	Blade transport, turbine and foundation component transport	OFW, MHK	330-470	66-75	21-32	FCP & AP
Deck Barge	Blade transport, turbine and foundation component transport	OFW, MHK	343 300	76 90	18 16	FCP & AP
Ocean Tug	Assembled Device Transport	OFW, MHK	145	50	18	FCP & AP
AHT	Assembled Device Transport	OFW	200-360	45-80	15-26	FCP & AP
Multi-Purpose Vessel	Assembled Device Transport, Device component transport	OFW, MHK	200-425	50-80	18-25	FCP & AP
Support Tugs	Assembled Device Transport support	OFW, MHK	105	40	16	FCP & AP

AHTs have been utilized to transport FPUs to and from the Puget Sound Area to Alaska, and may be available for towing OFW units in the study region. AHTs may be utilized to tow assembled OFW foundation structures to the U.S. from manufacturers in Asia, prior to assembly of the turbine units. As shown with the spar and semi-sub demonstration-scale prototypes, OFW floating foundations are able to be towed a significant distance in the water if needed. AHTs are required to maintain ABS certification.

Ocean tugs are typically available for use from marine contractors on the west coast such as Crowley, Foss, Harley Marine, and Sause Brothers. Multicat tugs are not typically available in the study area, but are widely available in Europe and may be procured for installment of commercial-scale MHK farm installation. All ocean going tugs require ABS certification.

MPVs may or may not be required for transport of OFW and MHK devices depending on the selection of other vessels which may provide similar functions. Should the developer select a MPV, for assistance during installation or assembly, it may also be able to provide tow or device component transport services.

Ocean going barges are designed for the transportation of cargo in open sea states. The deck barges provide advantages with open deck space for over-sized cargo, as well as shallow port access. Deck Barges are available from regional marine contractors such as Crowley, Sause Brothers, Foss, Manson, Kiewit, and Dutra. These barges are built to the requirements set by the U.S. Coast Guard and the ABS, as the building Class Society. The Class Society is charged with vessel inspection, construction parameters, and verification of standards. The corresponding Class Society documents are required to be carried on board the vessel at all times.

Bulk carriers are presently used to move wind turbine components on the U.S. West coast and elsewhere around the country. The size of the bulk carrier will be dependent on blade length and storage arrangement, and carriers operating in the open ocean environment will require appropriate ABS certification.

3.5.2.3 Assembly

Assembly support vessels are utilized in the assembly of the device, but not necessarily the installation at the project site. Assembly may occur on land, or in the water. As shown in Table 3-9, jack-up barges are not feasible for installation at the required depths, therefore, many of the specialized at-sea assembly vessels utilized for fixed-foundation offshore wind assembly are not able to be utilized and are not included as assembly vessels for this study. Table 3-14 summarizes vessels that may be utilized to conduct assembly procedures of wind turbines or MHK devices. This table includes only vessels already available and not OFW foundation specific vessels that may develop in the future to aid in installation of semi-sub, spar, or TLP foundations.

Table 3-14. Assembly support vessels

Vessel	Activities	Tech.	LOA (Ft.)	Beam (Ft.)	Draft (Ft.)	Port
Crane Barge (1000+ ton)	Substation Assembly	OFW ¹ , MHK	275	150	10	QRP & FCP or AP
Crane Barge (700-1000 ton)	Turbine Assembly	Spar, OFW	380	105	10	QRP & FCP or AP
Crane Barge (~100-500 tons)	MHK installation	MHK	100-200	40-70	5-10	QRP & FCP or AP
Ocean Tug	Device transport	OFW	145	50	18	AP
Multicat Tug	Device Assembly	MHK	85	38	8	AP
MPV	Device component transport, Assembled device transport, Device assembly	OFW, MHK	200-425	50-80	18-25	FCP & AP
Support Tugs	Assembly Support	OFW, MHK	105	40	16	AP

¹ Unless otherwise noted, OFW label applies to all three of Semi-sub, TLP, and Spar foundation technologies

Crane barges may or may not be required for OFW and MHK assembly, depending on the technology and installation location and depth. For example, the Spar may require a floating crane for installation of the turbine to the foundation, whereas a semi-sub technology may be fully assembled in dry dock and floated out.

Floating cranes are most feasible for use in assembly in a protected or semi-protected sea environment, rather than the open ocean of the Pacific Ocean. The longer period waves (i.e., >11 second peak wave period [Tp]) typically encountered in the Pacific Ocean affect motion of floating cranes greater than the shorter period waves typically encountered in the Gulf of Mexico due to a longer fetch length. It could therefore be difficult to assemble the wind turbine in exposed seas. Additionally, any crane barge used at sea must be properly ABS certified.

If in-water assembly of the turbine is not feasible, the turbine may need to be assembled on the floating foundation by a land-based crane in a dry dock or quayside. Should a jack-up barge or floating crane be deployed to open ocean sites, the barges must be in close proximity to a safe harbor that can accommodate it.

A cursory review of floating cranes availability on the west coast was conducted and found some, though limited, availability. Transport of the cranes may be required from the Gulf of Mexico or elsewhere in the U.S., and the marine contractors contacted for this study indicated that it could be done. In lieu of the availability of multicat vessels, crane barges may be required for installation of MHK devices. Smaller crane barges for support of MHK installations (if needed) are typically available on the west coast by marine contractors such as Manson and Kiewit.

MPVs have been utilized in demonstration projects in Europe, possibly due to their availability in the region. Depending on the project, MPVs may or may not be required for assembly of OFW and MHK devices, as many of their capabilities can be provided by a combination of vessels. However, if a developer decides to utilize an MPV for assembly of an OFW or MHK device, significant port facilities may be required.

3.5.2.4 Installation

Installation support vessels are utilized at the installation site, and may or may not be involved in the transport or assembly of the devices. A combination of vessels shown in Table 3-15 is expected to be required for installation of OFW and MHK devices. Exact vessel choice will vary and is dependent on the selected installation procedure for the selected device. However, at a minimum an AHT will be required for installation of the Semi-Sub OFW device. The towing vessel may be the same vessel that installs moorings for the device.

Table 3-15. Installation support vessels

Vessel	Activities	Tech.	LOA (Ft.)	Beam (Ft.)	Draft (Ft.)	Port
AHT	Installation Support	OFW	200-360	45-80	15-26	AP
Ocean Tugs	Installation Support	OFW	105	40	16	AP
MPV/OCV	ROV Installation Inspection, Dive support, MHK Device Installation, OFW Installation Support	OFW, MHK	200-425	50-80	18-25	FCP or AP
Crane Barge (<500 tons)	MHK installation	MHK	100-200	40-70	5-10	FCP or AP
Multicat Tug	Device Installation	MHK	85	38	8	FCP or AP
Support Tug	Device Installation	MHK	85	38	8	FCP or AP

3.5.2.5 Operations and Maintenance (O&M)

Table 3-16 summarizes vessels that may be required to support OFW and MHK development. At the time of this study there is not an O&M industry yet developed for OFW and MHK so assumptions are required. The majority of vessels supporting O&M requirements will likely be stationed at a QRP. It is expected that repair and maintenance will be either performed at sea or quayside. Unlike construction, repairs may be required to be conducted in winter wave conditions. The winter wave climate and depth of deployments may preclude repairs from being conducted at sea and therefore may require towing back to shore. Large repairs to OFW devices may not be able to be conducted in a QRP, and so long distance towing by an anchor handling supply vessel tug is another possible requirement.

According to one study, to support OFW O&M, one crew transfer vessel (CTV) vessel may be required for every 30 to 40 turbines, and for major repairs one MPV or offshore support vessel may be required for approximately every 80 turbines (ORRECA, 2014). Therefore, for a large windfarm (~80 turbines), two CTV vessels and one MPV or offshore support vessel may be required. In practice, one CTV vessel may be able to support an energy farm of 80 or more devices. Larger workboats or offshore support vessels may also be utilized, which can provide walk-to-work access via motion-compensating gangway.

Motherships to support CTV vessels at OFW or MHK farms that are far from any potential QRP may or may not be feasible with the wave climate in the study area (annual average significant wave height of approximately 7.5 ft.).

In order to conduct repairs in protected waters or in dry dock, MHK devices may be hauled on a barge or

in the water. Device removal may be on the order of every 2 to 5 years for scraping, repainting, maintenance, and repair (Advanced Research 2009). At sea repairs may be conducted via multicat vessel or a medium size workboat (Sandia 2014). Depending on the MHK technology, the vessel may require the following characteristics (Sandia 2014):

- Sufficient deck-space to handle mooring lines and cable repair;
- Dynamic positioning to allow for more effective operation; and
- Crane lifting capacity of 5 tons at 20-ft. radius.

Table 3-16. Operation and maintenance vessels

Vessel	Activities	Technology	LOA (Ft.)	Beam (Ft.)	Draft (Ft.)	Port
CTV	Operations and Maintenance	OFW	65	22	7	QRP
MPV (or barge)	Larger repairs	OFW	200-425	50-80	18-25	AP
Repair Barge	Larger repairs	OFW, MHK	343 300	76 90	18 16	AP
AHT	Tow to port for major repairs	OFW	200-360	45-80	15-26	AP
Crane Barge (700-1000 ton)	Turbine Repairs	OFW	380	105	10	AP
Crane Barge (<500 tons)	MHK installation	MHK	100-200	40-70	5-10	FCP or AP
Multicat Tug	Device Maintenance/Repair	MHK	85	38	8	QRP
Workboat or Offshore Support Vessel	Device Maintenance/Repair	MHK	85-200	30-50	-	QRP
Support Tug	Device Repairs, barge towing	MHK	85	38	8	QRP

3.6 Key Findings

A potential vessel database was developed based on the analysis of project prototypes and existing industries, metocean conditions, and vessel related activities identified for OFW and MHK development. Availability of vessels relative to specific OFW and MHK needs will be further addressed in Chapter 6 and have been preliminarily assessed as described in Appendix D. Example photographs of the vessels described in this chapter are located in Appendix E.

A summary of potential vessels for each port classification has been developed based on the potential vessel fleet and functions, and is shown in Table 3-17. A check mark indicates that the select vessel may need to be accommodated by each QRP, FCP, or AP for OFW and MHK. The navigation and berth requirements developed for assessment in Chapters 4 and 5 are based in part on the geometry of the vessels listed in Table 3-17. The vessels do not represent all vessels required for a single project; several of the same vessels in Table 3-17 can provide the same function. Ideally, and in most cases, one vessel may provide several functions (such is the case in Europe). Exact vessel selection will be dependent on project-specific variables not available at this time.

Table 3-17. Potential vessel fleet shown by port classification

Potential Vessel	Port			Technology		Comment
	QRP	FCP	AP	OFW	MHK	
Bathymetric Survey Vessel	<input checked="" type="checkbox"/>		<input checked="" type="checkbox"/>	<input checked="" type="checkbox"/>	<input checked="" type="checkbox"/>	QRP or AP
Research Vessel	<input checked="" type="checkbox"/>		<input checked="" type="checkbox"/>	<input checked="" type="checkbox"/>	<input checked="" type="checkbox"/>	QRP or AP
Cable Laying Vessel/Barge			<input checked="" type="checkbox"/>	<input checked="" type="checkbox"/>	<input checked="" type="checkbox"/>	Special-use
Offshore Construction Vessel (OCV)		<input checked="" type="checkbox"/>	<input checked="" type="checkbox"/>	<input checked="" type="checkbox"/>	<input checked="" type="checkbox"/>	Function may overlap with AHT/MPV
Multi-Purpose Vessel (MPV)		<input checked="" type="checkbox"/>	<input checked="" type="checkbox"/>	<input checked="" type="checkbox"/>	<input checked="" type="checkbox"/>	Function may overlap with AHT/MOCV
Bulk Carrier		<input checked="" type="checkbox"/>	<input checked="" type="checkbox"/>	<input checked="" type="checkbox"/>	<input checked="" type="checkbox"/>	May overlap with Deck Barge
ABS Certified Deck Barge	<input checked="" type="checkbox"/>	<input checked="" type="checkbox"/>	<input checked="" type="checkbox"/>	<input checked="" type="checkbox"/>	<input checked="" type="checkbox"/>	May overlap with Bulk Carrier
Ocean Tug		<input checked="" type="checkbox"/>	<input checked="" type="checkbox"/>	<input checked="" type="checkbox"/>	<input checked="" type="checkbox"/>	Multiple tugs may be required, project dependent
Support Tug	<input checked="" type="checkbox"/>	<input checked="" type="checkbox"/>	<input checked="" type="checkbox"/>	<input checked="" type="checkbox"/>	<input checked="" type="checkbox"/>	Multiple tugs may be required, project dependent
Multicat Tug	<input checked="" type="checkbox"/>		<input checked="" type="checkbox"/>		<input checked="" type="checkbox"/>	MHK only
AHT			<input checked="" type="checkbox"/>	<input checked="" type="checkbox"/>		May overlap with MPV, OCV
O&M Mothership		<input checked="" type="checkbox"/>	<input checked="" type="checkbox"/>	<input checked="" type="checkbox"/>	<input checked="" type="checkbox"/>	May not be required or feasible. Safe harbor needed.
Crew Transfer Vessel (CTV)	<input checked="" type="checkbox"/>			<input checked="" type="checkbox"/>		Operations and Maintenance.
Workboat or Offshore Supply Vessel			<input checked="" type="checkbox"/>	<input checked="" type="checkbox"/>	<input checked="" type="checkbox"/>	May be utilized for large component repairs
Crane Barge (100-500 ton)			<input checked="" type="checkbox"/>	<input checked="" type="checkbox"/>	<input checked="" type="checkbox"/>	Use depends on assembly procedure
Crane Barge (700-1000 ton)			<input checked="" type="checkbox"/>	<input checked="" type="checkbox"/>		Use depends on assembly procedure
Crane Barge (1000+ ton)			<input checked="" type="checkbox"/>	<input checked="" type="checkbox"/>	<input checked="" type="checkbox"/>	Use depends on facility power production

Key findings from the assessment of vessel requirements to support OFW and MHK on the Pacific West Coast are summarized below in primary, and secondary key findings:

Primary Findings OFW and MHK

- Many vessel combinations are possible that could provide the necessary capabilities for an OFW or MHK project. More than one vessel may provide several services and in some cases vessels shown in each section provide the same function as others in the section. The exact vessel fleet for installation work will be dependent on developer technology, vessel availability, economics, timeline requirements, location, proximity to port, and metocean conditions.

- Metocean conditions and depths in the study area most likely will preclude the use of certain marine equipment (or will be subject to downtime) during assembly and installation activities when subject to open ocean sea state (such as floating cranes, jack-up barges, and CTV motherships).
- Demonstration-scale energy farms will likely only use the vessel fleet already in use across the United States with potentially some limited specialty vessel charters for specific tasks. Manufacturing of new vessels is not expected to be financially feasible for use in demonstration-scale projects.
- Specialty cable laying vessels or barges will be required to lay the shore and array power cables for most grid connected OFW and MHK projects unless a power cable is already in place.
- Specialized vessels may require mobilization from elsewhere in the U.S., such as floating cranes, MPVs, AHTs, and Cable Laying Vessels.
- Specialty anchor-handling vessels will likely be required to install the moorings for OFW and MHK. They may also provide tow out of OFW devices. Vessel fleet findings for each port (QRP, FCP, and AP type) and technology (OFW, MHK) will be utilized to determine port berth and navigation requirements.

Primary Findings OFW

- Anchor-handling vessels which install moorings may also provide tow-out of OFW devices.
- The fixed foundation offshore wind market in Europe is highly developed and select vessel functions to be required for the OFW and MHK industries carryover to the U.S. HMM anticipates that individual vessels may be subject to Jones Act restrictions.

Primary Findings MHK

- MHK mooring installations will likely require a vessel capable of anchor handling and mooring installation.
- Installation vessel requirements for MHK technology may vary significantly due to variations in device geometry between MHK technologies. Vessels presented in this study are intended to be within the same order of magnitude for any MHK project; however, device specific vessels may be constructed for installation of the MHK devices.
- Vessels that have been used to install and maintain MHK in Europe (multicats) are not typically available in the study area, and therefore other vessels outfitted with cranes will likely be required for development of demonstration-scale projects. Multicats may be fabricated for commercial-scale MHK development.

Secondary Findings

- Project specific towing of OFW and MHK devices will likely be subject to a marine warranty survey in order to be insured during transport, based on similar tows in the oil and gas industry. This process requires detailed analysis to determine required bollard pull of the towing vessels.
- Vessel related activities for floating ocean energy development typically includes, at a minimum, the following:
 - Pre-installation surveys (bathymetric, marine mammal/birds, benthic, geotechnical, metocean)

- Shore-power and array-power cable laying
 - Mooring installation
 - Energy device installation
 - Technician and equipment transfer including regular maintenance
- Similar floating foundation technology has been utilized for FPU's in the Oil and Gas Industry (Spar, Semi-Sub, TLP), though the FPU substructures appear to typically be larger. Because of the similarities, installation and transport requirements of these units has been considered as prototypes for this study, while also considering differences in magnitude.
 - Demonstration projects may opt to utilize a single MPV vessel which could be modified to conduct cable laying, ROV, mooring installation, and device install in order to reduce costs.
 - OFW Assembly ports should be able to accommodate an AHT.
 - OFW QRPs must be able to accommodate CTVs.
 - Floating cranes may be utilized for OFW or MHK demonstration projects, but due to downtime associated with the wave and wind climate in the Pacific, alternative methods may be developed for commercial-scale projects.
 - Vessels utilized for installation will be required to have certification through the U.S. Coast Guard for use in open ocean conditions outside of protector harbors.
 - Safe harbor must be accessible within close proximity for vessels utilized which are sensitive to sea state conditions.

4. Assessment of Port Infrastructure Characteristics Needed to Support Floating Offshore Wind and Marine Hydrokinetic Technologies

4.1 Introduction

In this chapter, port infrastructure characteristics for classifications of port functions to support offshore floating wind (OFW) and marine hydrokinetic (MHK) industry development are described. Results from this analysis are used to assess existing port facility infrastructure and develop a gap analysis. Similar to Chapter 3, port infrastructure requirement findings are based on prototype analysis of similar industries, literature review, project assumptions, and operational and facility restrictions. In addition to higher volume commercial-scale ports, requirements for demonstration and smaller scale wind and MHK projects will be addressed. Analysis and findings in this chapter are divided into the following sub-sections:

- Identifying functions and activities that the ports need to provide the capability to support OFW and MHK technology development;
- Conducting a prototype analysis and literature review for fixed-foundation offshore wind ports;
- Describing the regulations and restrictions that apply to the port functions and activities; and
- Determining a range of port infrastructure facility requirements, depending on technology type.

The potential vessel requirements developed in Chapter 3 are critical to determining harbor entrance and berth geometries required for OFW and MHK development. These vessels are shown by port classification and technology in Table 4-1.

4.2 Prototype Analysis

A review of existing ports providing facilities for offshore wind development and literature review of studies evaluating U.S. ports was conducted. Additionally, a cursory review of port infrastructure and procedures was conducted. Several studies have been developed to assess port infrastructure requirements for fixed-foundation offshore wind farm development in the U.S., which are referenced in this report. In addition, several ports in Europe currently provide services for offshore wind farm construction. These studies and existing ports have been reviewed for their applicability to OFW. Several demonstration-scale MHK devices have been deployed, as described in Chapter 3 for vessel-related aspects and will be described below as they relate to port infrastructure requirements.

4.2.1 Fixed Foundation Offshore Wind

This prototype analysis for offshore wind port facilities is divided between existing offshore wind port facilities in Europe, literature review of several studies for fixed-foundation wind estimating port facility requirements to support future U.S. offshore wind development, and a review of port facilities utilized for the deployment of demonstration-scale projects (existing and proposed).

4.2.1.1 European Wind Farm Port Facilities

Many ports and private facilities in Europe presently support construction and maintenance of offshore wind farms due to the highly developed nature of the industry in the area. To conduct a prototype analysis two ports were selected that provide different functions. The two selected ports are located in Bremerhaven, Germany (see Figure 4-2) and the Breakbulk and Offshore Wind (BOW) Terminal in Vlissingen, The Netherlands (see Figure 4-1).



Figure 4-1. BOW Terminal handling foundations (BOW Terminal 2014, Renewables 2014)



Figure 4-2. Existing Bremerhaven port terminal. (Bremerhaven Port 2016)

Bremerhaven is used as an example of an existing offshore wind cluster location (FCP and AP); whereas, BOW terminal is an example of a fabrication site terminal (FCP). Bremerhaven is planning for an additional offshore-specific terminal to be constructed in the near future in addition to its existing facilities. Both of these ports provide for commercial-scale offshore wind and are not representative of the scale of facilities required for demonstration-scale projects.

The fixed-foundation turbines are typically assembled offshore at the project site after installation of the foundation. The ports supporting offshore wind in Europe are often referred to as “Staging Ports,” as the major components are staged for transport and assembly at site. These ports are typically used to transport the major components (foundations, nacelles, etc.) onto vessels or barges that will assist or conduct the assembly of the complete unit at sea using jack-up technology. Though the foundation technology is different (i.e., fixed vs. floating), material and assembly requirements may be similar to floating foundations, and so should be considered similar for commercial-scale staging needs for OFW. Because the turbines are assembled at sea, foundations and turbine components may be fabricated and mobilized

from different ports, only meeting at the installation location at sea.

Characteristics of these terminals are shown in Table 4-1. The characteristics shown below will be used to aid in establishing a range of expected assembly port infrastructure characteristics for OFW. The future offshore terminal at Bremerhaven is expected to be able to handle assembly and load out of approximately 160 turbines per year.

Table 4-1. Prototype port characteristics

	Bremerhaven Proposed Offshore Terminal Facilities (Bremenports 2011)	BOW Terminal (BOW 2016)
Throughput Capacity	160 turbines/year	Fixed Foundations
Navigation Channel Width	N/A	250 m
Navigation Channel Depth	46 ft.	34 ft.
Air Draft	Unlimited	Unlimited
Berth	1640 ft. quay length 2-3 berths 230 ft. heavy duty slab	1110 ft. + 4590 ft. berth length 35 ft. draft Accommodates jack up vessels
Harbor Location	~25 miles to open sea	1 hour to open sea. Project sites > 500 miles
Crane	Multiple 750 metric ton (mt) Crawler Cranes (Existing Terminal)	1200 mt fixed crane Mobile telescopic cranes up to 400 mt Mobile harbor cranes 100-400 mt Cherry pickers
Other Equipment	24/7 access Logistics center	SMPTs for loads up to 1000 mt Trailers, Offices, Scaffolding Heavy lift personnel 24/7 access Breakbulk terminal on site
Area	60 acres Staging areas for 6 foundation structures, 18 tower segments, 6 hubs, 6 nacelles and 18 rotor blades, 6 “rotor stars” Assembly area for the erection of jackets and tower segments, transformer substation	50 acres of storage Covered Storage Typically does not stage turbine components, foundations only.
Road/Rail	Transport routes > 300 ft. in length > 100 ft. in width	Railway siding on terminal Direct Highway Access

4.2.1.2 Literature Review

To estimate existing and future port infrastructure needs in the U.S. and Europe to support offshore wind, a number of studies have been conducted for various entities (U.S. Dept. of Energy, State of Maryland,

Massachusetts Clean Energy Center, New Jersey Dept. of Transportation, Federal Highway Administration, and European Commission). The studies focus primarily on fixed-foundation offshore wind as this technology is already in use in Europe on a wide scale, unlike OFW, which is not in use. Selected notes from several of these studies is found in Appendix H, and a summary of the notes is shown in Table 4-2. The characteristics shown below will be used to aid in establishing a range of expected infrastructure characteristics for the three OFW port classifications used in the current study.

Table 4-2. Literature review notes of fixed-foundation offshore wind characteristics as applied to OFW assembly ports (FCP, QRP as noted)

Criteria	Minimum Requirement
Throughput Capacity	Commercial-scale: 30+ turbines. Demonstration-scale: <5 turbines.
Navigation Channel Width	Approximately 300 ft. 400 ft. horizontal clearance for transport of blades.
Navigation Channel Depth	24 -32 ft. minimum depth.
Air Draft	Unlimited
Berth	450 ft. length, 24-ft. depth minimum. Ideally more than 1 berth 450 ft. long. Ideally one 80-ft. berth. ~1000 ft. quayside length. ~100 ft. clear width on the berth for maneuvering. 1000 pounds per square foot (psf) minimum bearing capacity (potentially less for MHK). Ideally 2000 psf bearing capacity.
Harbor Location	QRP within 2 hours of devices. Staging port may be hundreds of miles from installation location. Larger distance from port will result in lower throughput rate
Crane	1000 ton crane. Preferred to be on rails. Other smaller cranes needed for component assembly/movement.

Criteria	Minimum Requirement
Area	<p>Studies provide a wide range of upland acreage requirements (i.e. 11, 20, 60,100, and 200 acres.</p> <p>Upland acreage requirements based on size of the project, co-located manufacturing facilities, and efficiency of installation.</p> <p>Demonstration projects likely will likely used existing facilities and not buy project-specific land.</p> <p>10 acres for MHK assembly and staging.</p> <p>0.5-2.5 acres for offices (QRP).</p> <p>Offices may be located remotely (QRP).</p> <p>Tower manufacturing: 3 to 50 acres</p> <p>Nacelle manufacturing: 15 to 25 acres</p> <p>Blade manufacturing: 37 to 62 acres</p> <p>Generator manufacturing: 15 to 19 acres</p> <p>Foundation manufacturing and staging: 30 to 50 acres</p> <p>Submarine cable: 20 to 22 acres</p> <p>Substation construction: Specialty construction in existing shipyard</p> <p>Construction Staging: 40-50 acres</p>
Air Draft	Unlimited
Other Equipment	Crawler cranes, forklifts, cherry pickers, multiple axle trailer, self-propelled modular trailers (SPMTs)
Road/Rail	<p>Highway and Rail connections needed.</p> <p>90-ton limit typically, up to 400 tons on rail. Curvature limits exist and may restrict blade transport.</p> <p>First generation vertical rail clearance is 19 feet above the top of rail (ATR). Second generation generally 22.5 feet ATR. Lines to ports may differ.</p> <p>Most OFW components can be transported by rail.</p> <p>MHK likely to be designed for transport over rail/road. Otherwise barges needed.</p>
Dock/Quayside Bearing Capacity	<p>1000 psf minimum with mitigation measures. 2000 psf preferred.</p> <p>2000 psf usually not feasible on pile supported wharves.</p> <p>1000 psf may be required at QRP.</p> <p>SPMTs likely required for larger OFW turbine components to meet allowable bearing capacity.</p>
Offshore substation	<p>May be in excess of 1300 tons for large scale projects</p> <p>Specialized crane required.</p> <p>Smaller projects may not require substation at sea</p> <p>Typically ~6.5 tons per MW at substation.</p>
Manufacturing/Labor	Secondary criteria. Few specifics on requirements.
Vessels	<p>Accommodate vessels 450 ft. LOA, 22-27 ft. draft, and 75-150 ft. beam.</p> <p>1 Crew Transfer Vessel per 35-40 turbines.</p>

4.3 Demonstration-scale Projects

Some existing demonstration-scale projects were identified in Chapter 3 as the Hywind Spar Buoy device in the North Sea off the coast of Norway and the WindFloat Semi-Submersible device in the Atlantic Ocean off the coast of Portugal. The two projects utilized similar size wind turbines, but varied greatly in assembly procedure. A brief description of the two projects follows. Currently, a three-device project is planned for the Oregon Coast outside Coos Bay utilizing the WindFloat technology.

4.3.1.1 Hywind Spar

The 2.3 MW Hywind Spar Buoy was constructed and deployed in 2009. The main spar was constructed by Technip in Pori, Finland (see Figure 4-3). The Technip yard constructs spars and other floating foundations for the oil and gas industry, which are transported to the Gulf of Mexico for final assembly. The Technip facility can be considered an example of a construction port (FCP) since the final assembly took place elsewhere. The construction facilities at Technip include the following (Technip 2016):

- 9-acre heated covered workshop space.
- Main assembly hall ~500 ft. x 100 ft. x 100 ft., with 80-ft. hook height.
- ~4 acres of office and heated storage areas.
- 330-ton, 160-foot assembly crane, and 2,400 ton lifting system.
- Two (2) heavy (450 t/m and 280 t/m) assembly and loadout rails for spar hull loadout.
- Purpose built 11,000-ton barge.

The Hywind demonstration device was towed 650 nautical miles (nmi) to intermediary sheltered deep water near Gotheburg, Sweden where it was uprighted. Once uprighted in water depth of approximately 350 ft., the turbine tower, nacelle, and rotor were assembled by floating crane (example of assembly port). The assembled unit was towed upright 250 nmi to the final installation location. It is located 10 km off the coast of Norway in approximately 650 ft. of water, and displaces approximately 5300 m³ of water (Hywind 2015).



Figure 4-3. Hywind construction location in Pori, Finland (Technip 2013)

Due to constraints the deep draft (>250 ft.) of the Hywind floating foundation has on installation and assembly procedure, the developer (Statoil) is interested in developing technology specific marine infrastructure to aid in deployment of the technology. The technology would allow installation in locations where sheltered water areas with depth greater than 300 ft. is limited (such as the West Coast of the U.S.). Statoil conducted a competition to develop new methods for installation and assembly of wind turbines on the Hywind technology. Three winners were announced in August 2015 (Atkins, MODEC, and Ulstein), but limited information is available on the type of infrastructure that would be required. Figure 4-4 shows visualizations of the potential installation types. This potential change installation methodology is an example of how technology in this industry is still in development.

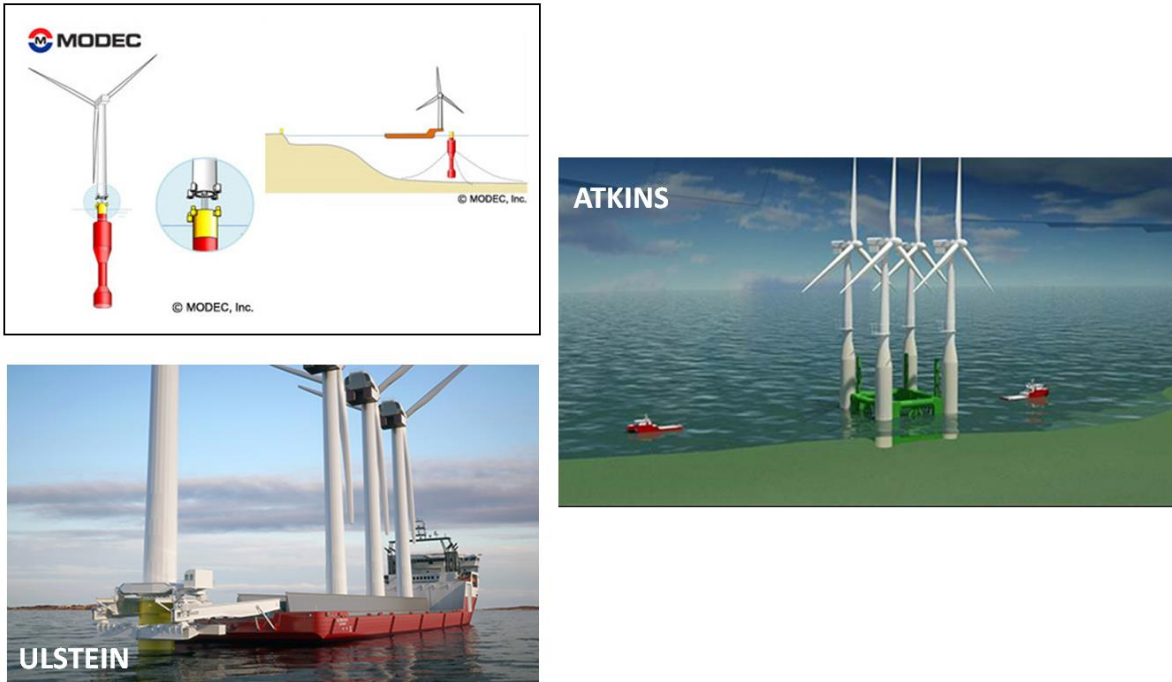

Figure 4-4. New potential Hywind installation procedures (Statoil 2015)

4.3.1.2 WindFloat

The WindFloat demonstration project in 2009 was constructed in Lisbon, Portugal, and used a 2.6 MW device. The components were fabricated by a metal fabricator in the area and assembled at dry dock in the Lisnave Shipyard. The primary crane at the dry dock where the device was constructed has a capacity of 500 tons. The entire unit was assembled in dry dock including the floating foundation, the tower, nacelle, and rotor. The dry dock used has a width of approximately 250 ft.. In addition to the 500 ton crane, several 100 ton cranes were used. The assembled unit was floated out of the dry dock using additional floats to reduce the draft for transportation in the river. It was then towed out to the Atlantic where it was installed in 150 ft. of water, 225 miles from port.

The WindFloat technology is also proposed to be installed offshore of Coos Bay, Oregon in a demonstration-scale project. It is proposed to construct the floating foundations at a construction port, and then tow the foundations to an assembly port (transit draft approximately 23-27 ft. without turbine affixed). At the assembly port the tower, nacelle, hub, and blades will be assembled and affixed to the floating foundation using a temporary mobile crane. Required hub height is approximately 330 ft. and requires lifting a 400 ton nacelle. Minimum depth requirements once assembled are approximately 32-40

ft., dependent on project specifics. In order to handle the blades quayside, a clear space of 120 ft. wide by 650 ft. in length may be required.

Larger commercial-scale projects will likely require larger permanent infrastructure. In order to be constructed in dry-dock, the facility must meet minimum width requirements for the device (exact device dimensions may vary for each project need). Construction of the foundation may be located in a different port than the final device assembly location.

4.3.2 Marine Hydrokinetic

Example MHK demonstration projects were identified in Chapter 3 and vessels used for installation and assembly were discussed. This section describes port facility infrastructure used in these prototype example projects.

4.3.2.1 Pelamis

The Pelamis device deployed off the coast of Scotland was constructed in Leith, Edinburgh, U.K., as shown in Figure 4-5 (Yemm *et. al.* 2011). According to these authors, “Land-based modular construction requiring minimal weather windows for rapid offshore installation is an essential engineering feature necessary for viable commercialization.” and “The harsh offshore environment prohibits general access for repairs and maintenance, so a method is required to enable rapid removal and installation of machines across a range of sea conditions commonly available throughout the year. As Pelamis has a long, thin shape, it can be easily towed by small vessels, and its shallow draft requires only a few meters of water depth to enter sheltered facilities.” (Yemm *et. al.* 2011). Inspection and maintenance work is currently carried out at the village of Lyness, on the Orkney Islands, where the machine is located when not at the wave test site, ready for redeployment in suitable weather windows (European Marine Energy Center 2011). The pier at Lyness was previously a naval facility.

The major device components (similar to those shown in Figure 4-5) were transported from the fabrication facility to the quayside area by use of a self-propelled modular trailer (SPMT) by Mammoet. At the quayside location the device was lifted into the harbor in tandem by two 500 metric ton (mt) cranes lifting in tandem (i.e., four sections, each section weighs approximately 190 mt) (Renewable Energy World 2011).



Figure 4-5. Pelamis device installation (Yemm *et al.* 2011)

4.3.3 Ocean Power Technologies

The Ocean Power Technologies (OPT) Power Buoy device was constructed at Oregon Iron Works, and

had been planned for deployment off the coast of Reedsport, Oregon. Though the device (Figure 4-6) completed construction, it was not deployed in Oregon. OPT had planned to use the services of several companies in Oregon: American Bridge of Reedsport, Oregon; Northwest Underwater Construction (mooring); and Knutson Towboat Company. The buoy was transported via barge, with the largest component 18-ft. wide, 117-ft. long and weighing 150 tons (Northwest Structural Moving (NWSM 2013)). NWSM was contracted to move the components from the fabrication site to the pier where they would be loaded onto two barges. The three smaller components consisting of the “heave plate,” “float,” and “bridge assembly” were loaded onto the first barge. The main component known as the “spar” was loaded onto the second barge. NWSM used its remote control self-propelled transport system to ensure smooth and level movement of the components without the use of a truck. Use of the SMPT is shown in Figure 4-7.



Figure 4-6. Example of staged full-size MHK device using scaffolding (Hug Energy Inc. 2015)



Figure 4-7. MHK barge loading at Oregon Iron Works (NWSM 2013)

4.3.4 Oil and Gas Industry

Semi-subs, Spars, and tension-leg platform (TLP) devices which are installed in the Gulf of Mexico are typically constructed in the Gulf of Mexico (Brownsville, Houma, Ingleside), or constructed internationally (Asia, Europe) and transported to an assembly port on the Gulf of Mexico.

An example of this is the facility where the Hywind prototype was constructed. A Technip facility was responsible for construction of the Heidelberg foundation, a 110-ft. diameter, 600-ft. long, Truss Spar

which was installed in the Gulf of Mexico. The device was towed to Ingleside, Texas, and final assembly of the topside took place in the Gulf of Mexico (see Figure 4-8). This device is approximately twice as long and three times the width as the Hywind prototype.



**Figure 4-8. Gulf Island Fabrication Company, Ingleside, Texas.
(Center for Land Use Interpretation 2016)**

4.4 Regulations and Guidelines

To estimate infrastructure requirements based on required port functions and activities, the regulations and restrictions that govern these requirements need to be considered in order to be properly evaluated.

The following regulations, restrictions, and organizational standards were reviewed for incorporation into port facility infrastructure assessment:

- The World Association for Waterborne Transport Infrastructure (PIANC)
- United States Department of Transportation
- Occupational Safety and Health Administration (OSHA)
- American Bureau of Shipping (ABS) Building and Classing Standards for Offshore Floating Wind

4.4.1 PIANC

The World Association for Waterborne Transport Infrastructure (PIANC) provides guidelines for the design of navigation channel depth and width in their publication Harbour Approach Channels - Design Guidelines Report n° 121 – 2014 (PIANC 2014). PIANC has Technical Commissions concerned with inland waterways and ports (InCom), coastal and ocean waterways (including ports and harbors) (MarCom), environmental aspects (EnviCom) and sport and pleasure navigation (RecCom). Report n° 121 was produced by an international Working Group convened by the Maritime Navigation Commission (MarCom). Members of the Working Group represent several countries and are acknowledged experts in their profession. The objective of the report is to provide information and recommendations on good

practice. Conformity is not obligatory and engineering judgement should be used in its application, especially in special circumstances (PIANC 2014). Guidelines in this report were developed to provide conceptual level estimates of navigation channel access requirements for the design vessels and devices for the study.

4.4.2 U.S. Department of Transportation

4.4.2.1 Helipad Requirements

The advisory circular Heliport Design #150/5390-2C (Federal Aviation Administration 2012) provides standards for the design of heliports serving helicopters with single rotors. The helicopter landing and takeoff pad (TLOF) and other safety parameters for the helipad are shown in Appendix I.

4.4.2.2 Overland Transport Regulations and Standards

Overland transport regulations and standards were discussed in Chapter 2 and are summarized in Appendix F.

4.4.3 Occupational Safety and Health Administration

OSHA provides guidance on port lighting restrictions, which can impact the ability to handle very long cargo. Based on 29 C.F.R. 1917.123, areas where employees are working must provide at least 5 candles of light, and must not be in the line of sight of workers. Typically this results in light pole spacing of 250-400 ft., depending on the power and height of the lights.

4.4.4 American Bureau of Shipping

ABS is one of the major classification societies in the marine industry. In addition to classifying vessels, ABS has developed certification criteria for OFW structures.

In order for the floating wind turbine to be ABS certified as an “A1 Offshore Wind Turbine Installation (Floating)”, the installation must follow guidelines in the ABS document, Guide For Building and Classing Floating Offshore Wind Turbine Installations (ABS 2013).

In this document, periodic minimum periodic inspections are required as follows:

- An Annual Survey of the Floating Offshore Wind Turbine Installation is to be carried out.
- A Special Periodical Survey of the Floating Offshore Wind Turbine Installation is to be carried out within five (5) years of the initial Classification Survey, and at five-year intervals thereafter.
- Underwater inspections can be considered as an alternative to the dry-docking surveys. A minimum of two underwater inspections is to be carried out during each five-year period of Special Periodical Survey.

4.5 Vessel Navigation and Berthing

4.5.1 Navigation

Based on an assessment of the potential vessel fleet which may be required to support these industries, conceptual-level navigation horizontal channel geometry requirements were estimated based on international guidelines (PIANC 2014) and the United States Army Corps of Engineers (USACE 2006) to support the fleet. Additionally, conceptual-level analysis of the navigation requirements for OFW and

MHK devices was conducted. Figure 4-9 shows a visualization of the cross-section of a navigation channel.

The channel dimensions are defined not only by its geometric characteristics but also by its aids to navigation, its limiting operating conditions and by any need to use the assistance of tugs or patrol vessels to safely navigate the channel. A more detailed design phase is required to assess the adequacy of the navigation channel, and may result in less conservative requirements.

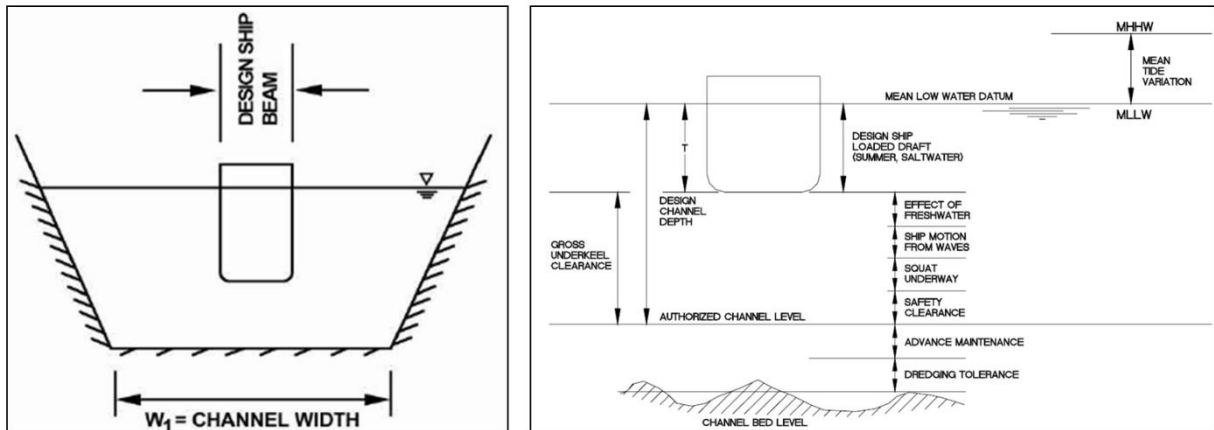

Figure 4-9. Navigation channel width (left panel) and depth (right panel) diagrams (USACE 2006)

Some vessels shown have a range of sizes based on potential geometry discussed in Chapter 3. USACE document EM 1110-2-1613 states a value (navigation channel width) of 2.5 times the design ship beam for canals with negligible currents should be conservative (USACE 2006). Therefore, an approximate lower bound of potential navigation channel width requirements is assumed to be 2x vessel (or device) beam (herein referred to as “ideal”), for 1-way traffic for channels with negligible currents. Appendix G shows conceptual level limiting navigation channel geometry in ideal conditions. Ideal conditions were selected as to not preclude certain ports from being considered, even if only accessed with ideal conditions.

4.5.2 Berthing

Based on an assessment of the vessel fleet that may be required to support OFW and MHK conceptual-level berth requirements were estimated. The assessment is based on national (USACE 2006) and international standards (ABS 2014, PIANC 2002) and the potential vessel fleet. A more detailed design phase is required to assess the adequacy of the facility, which considers specific metocean conditions to the location of the facility, and may result in less conservative requirements. Furthermore, it is assumed that should a port state the capability to support a certain length vessel, that the port facilities meet standards. General requirements for shore parallel berths include the clearance between vessels at berth, width of dredged tidal berth, and the length of the dredged area, as shown in Figure 4-10. Conceptual-level vessel berthing diagram More detailed analysis of berthing requirements for the potential vessel fleet is located in Appendix G.

OFW foundations, and some MHK devices, have significant beam, and berthing width requirements, greater than most of the support vessels that will be using the ports. If berthed quayside at an Assembly Port, Construction Port, or Cluster Port, the device should have a clearance from the edge of the nearby navigation channel (and passing vessels) that meets local USACE requirements. The specific offset

distance may vary by restriction, but based on initial review the required offset distance is approximately 100 ft.

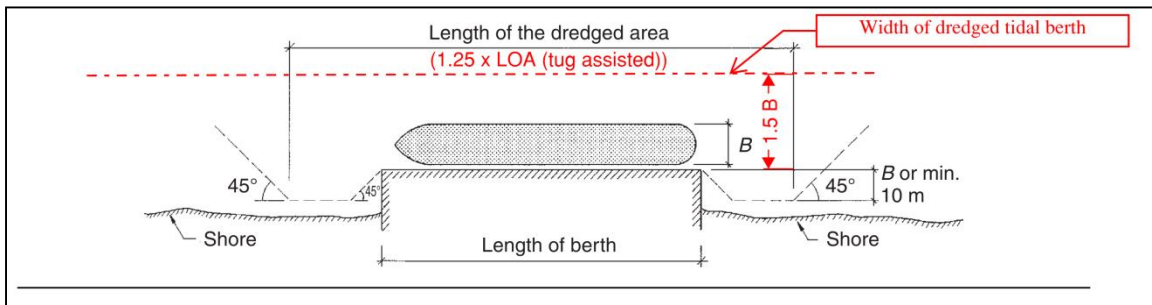

Figure 4-10. Conceptual-level vessel berthing diagram

4.6 Port Infrastructure Requirement Criteria Results

Port facility infrastructure requirements for commercial-scale and demonstration-scale OFW and MHK development is assessed in this section and is based on the prototype analysis, vessel analysis, review of existing studies, and discussions with developers. Port facility requirement criteria will differ for each port classification and technology as the functions and vessel requirements are different. Because the industry is early-stage, and deployment technologies and methodologies are still in development, the requirements presented in this section are intended only as a broad review of likely port facility requirements based on available data and technology. Technology yet to be developed that is device or project specific cannot be estimated or included in the study at this time. Specific projects will have individual needs that will need to be analyzed in more detail prior as part of project planning, and which may differ from the criteria presented herein. Additionally, the requirement criteria presented is not necessarily applicable to demonstration-scale projects, unless otherwise noted. Demonstration and other early stage projects will likely rely on available infrastructure and will not have the resources to develop technology specific facilities that would increase production efficiency to the level needed for commercial-scale projects.

Primary and secondary facility requirement criteria are presented for each port. Primary criteria include port characteristics that are very difficult to mitigate, whereas secondary criteria represent port characteristics that may be mitigated by redevelopment, construction of new infrastructure, or procurement of equipment.

Because each port classification provides different functions, the primary and secondary criteria may differ for each port classification. Estimated requirements for the port classifications are divided between OFW and MHK for the QRP and FCP ports since these requirement criteria were found to differ between the technologies. The estimated requirements for AP ports are divided between two tables: one for OFW which details the different OFW technologies separately (Semi-Sub, Spar, TLP); and one that parameterizes requirements for MHK.

4.6.1 Quick Reaction Ports

4.6.1.1 Navigation and Berthing

It is likely that bathymetric, benthic, and other pre-construction surveys will be based out of the QRP for both OFW and MHK projects. The crew transfer vessels (CTVs) will be based out of the QRP for OFW projects and must be able to reach the windfarm within 2 hours. This may limit the available location of windfarms to being sited near a QRP. The number of berths required is dependent on the number of

turbines in the array. Navigation requirements are based on conceptual-level navigation channel analysis.

MHK operation and maintenance requirements are less well known than that of the OFW devices since the industry is in its nascent stage. It has been assumed that MHK maintenance will be conducted by a coastal or multicat tug, and may require towing of the device to shore for repairs.

4.6.1.2 Upland Infrastructure

Operations and maintenance will require service parts and other equipment to be delivered to the QRP. To meet this demand, the QRP should have at a minimum highway access.

Rail may not be required since major repairs will be conducted out of either the construction port or the assembly port. Based on review of existing QRPs and literature, 1-2 acres of upland space will be needed to serve as a base of operations.

The WindFloat device is outfitted with a helipad, and maintenance work may be accessed via helicopter. Helicopter access may also be available by landing on top of the nacelle. The helipad at the QRP must meet FTA standards. Cranes should be available to load the crew transfer vessel with minor repair components. Floating wind devices will require periodic maintenance and inspection of the structure, which may include towing to port (not to QRP) or dive inspections. Depending on the device type, MHK technology may need to be towed to port for maintenance and repair (i.e., Pelamis)

Table 4-3. Quick Reaction Port facility criteria shows navigation and facility infrastructure divided between primary and secondary criteria.

Table 4-3. Quick Reaction Port facility criteria

Criteria	OFW	MHK	Comment
Throughput Capacity	30+	30+	Demonstration-scale project requirements may differ.
Primary Criteria			
Navigation Channel Width	100 ft.	100 ft.	CTV and coastal tug.
Navigation Channel Depth	12 ft.	12 ft.	CTV and coastal tug.
Air Draft	~100 ft.	~100 ft.	CTV and coastal tug.
Max Vessel Length	75 ft. LOA	75-85 ft. LOA	CTV and coastal tug.
Max Vessel Draft	10 ft. draft	10-11 ft. draft	CTV and coastal tug.
Number berths	1 berth	1 berth	Assume similar vessel count requirements for MHK farms and OFW.
Harbor Location	<40 nmi from the project site	<40 nmi from the project site	Must be within 2 hours of project site.
Area	1-2 acres	1-2 acres	MHK may be remotely operated, but staging area for repair and maintenance facility required.

Criteria	OFW	MHK	Comment
Secondary Criteria			
Other Equipment	Forklifts, crawler cranes, cherry pickers.	Forklifts, crawler cranes, cherry pickers	Transport of minor repair components and maintenance equipment.
Skilled Labor Pool and Manufacturing	Base of skilled technicians required.	Base of skilled technicians required.	
Helipad	84 ft. Safety Zone	Likely not required	
Quayside Bearing Capacity	N/A	N/A	Major components not handled at QRPs. Significant repairs will occur at assembly port.
Road/Rail	Highway connection	Highway connection	Repair and maintenance components.
Crane	~5 ton	~5 ton	Could be purpose-built. If the device needs to be lifted out of the water for repairs, a larger crane may be required.

4.6.2 Fabrication and Construction Ports

4.6.2.1 Navigation and Berthing

Navigation and berthing requirements at FCP OFW ports are likely to be limited by the vessels utilized to transport large components (blade, nacelle, etc.) and the transport of constructed OFW foundations (not including the turbine).

Table 4-6 shows likely port facility characteristics for fabrication, construction, and transport of floating foundation in one column, and floating foundations in another column. Port facility characteristics for MHK technologies are shown in the right column. Transport of components will likely be conducted either by bulk carriers or deck barges. Bulk carrier vessels may be up to approximately 500 ft. in length, and FCP OFW ports should be able to accommodate these vessels. Alternatively, the manufactured components may be shipped via barge. A higher throughput rate may require larger-scale bulk carrier vessels, which may require deeper channel dimensions than those shown in Table 4-6.

Transport of constructed foundations will require adequate navigation depth, navigation channel width. Navigation depth required to tow the floating foundation at the FCP is less than at the AP because the turbine is not yet affixed, similar to a light draft vessel with a light load. Another consideration is berth clearance from nearby passing vessels. The beam (width) of the OFW devices is considerably larger than vessels of the same tonnage. Berthing of the device quayside should allow approximately 100 ft. from the edge of the structure to the edge of the navigation channel (specific requirements vary based on USACE district).

MHK port navigation and berths are likely to be controlled by either bulk carrier vessels or deck barges. MHK device components are assumed to be transported to the assembly port location for final assembly. Marine towing of fully assembled devices will occur from the AP port only. Demonstration-scale MHK projects may not require deep draft bulk carrier for transport of MHK components.

4.6.2.2 Upland Infrastructure

FCPs include manufacturing and construction of the OFW and MHK units, and component import/export. Based on review of the existing offshore wind industry in Europe, studies conducted evaluating potential U.S. facilities, and discussions with developers, significant manufacturing capability is required for the construction of OFW foundations and turbines. Significant upland area is required to house the manufacturing facilities required to support OFW. Different manufacturing and construction activities will likely have different component specific transport and upland area requirements. Each element of the turbine (blades, nacelle, tower), could require 10-20 acres, or more, for commercial-scale fabrication facilities. Staging and transport could require another 10-50 acres depending on the throughput and component type. Facility requirements in

Table 4-4 indicate the likely minimum facility requirements for a port to produce a single component type. Array and shore cables are assumed to be fabricated at existing facilities elsewhere.



Figure 4-11. Example of specialized upland equipment to maneuver blades (Siemens 2014)

Dry dock capability may be preferred by developers for construction of the floating foundation. Depending on project specifics the dry dock may need to accommodate a device (Semi-Sub, Spar) width between 175 and 225 ft. or greater. The Principle Power pilot project in Portugal showed an example of construction of the foundation co-located with assembly in dry dock. Alternatively the foundations and turbine components may be constructed upland or in other purpose-built facilities, as found in Europe at ports like Blexen, Cruhaven, and Bremerhaven. Early stage or demonstration projects will likely utilize available construction and fabrication facilities rather than purpose built facilities.

To manage movements of the raw material and smaller components required for fabrication and construction of the foundation and turbine components adequate overland transport connections are required. This could be a combination of road and rail, or direct rail access. The size of the larger constructed components (nacelle, tower, etc.) precludes the use of truck transport. The components need to be transported from the fabrication facility to the assembly port via either rail or marine transport. Ideally the fabrication facilities are co-located with the assembly port as a cluster.

Table 4-6 shows navigation and facility infrastructure divided between primary and secondary criteria.

Table 4-4. Fabrication and Construction Port facility criteria

Criteria	OFW Foundations	OFW Turbine	MHK	Comment
Throughput Capacity	30+	30+	30+	The number and rate of turbines constructed.
Primary Criteria				
Navigation Channel Width	Spar: <200 ft. Semi-Sub: ~330 ft. TLP: 300-450 ft.	~150-200 ft.	150-200 ft.	MHK components assumed to be transported via barge or bulk carrier. 2x device width (beam) as ideal conceptual minimum:
Navigation Channel Depth	28 ft. minimum. Specific devices may have slightly different values.	25 ft. minimum. 38 ft. ideal.	25 ft. minimum. 38 ft. ideal.	Constructed foundation transport and bulk carrier.
Harbor Location	Worldwide	Worldwide	Worldwide	May be limited by Panama Canal (106 foot beam).
Skilled Labor Pool and Manufacturing	Significant skilled labor pool required	Significant skilled labor pool required	Significant skilled labor pool required	
Area	~50 acres, depending on throughput.	10-20 acres minimum to provide an element of construction. May be up to ~100-200 acres for multiple fabrication facilities. ~650 feet of quayside length may be required for blade maneuvering	1-5 acres	Dependent on size of project. Not counting assembly staging. Demonstration-scale area requirements are smaller.
Road/Rail	Highway connection required. Rail preferred.	Transport of constructed turbine components via rail require non-standard rail cars	Highway connection required. Rail preferred.	Required for delivery of raw materials. Next generation of wind components likely not transportable via road.
Secondary Criteria				
Max Vessel Length	~470 ft. vessel	Device moored appx. >100 ft. from Nav. Channel	~470 ft. vessel	Bulk carrier. Demonstration-scale projects will likely use smaller barges.
Air Draft	150 ft.	150 ft.	150 ft.	Bulk carrier. Less if barges are utilized.
Berth Depth/ Max	28 ft. berth depth	25 ft. berth depth	25 ft. berth	Minimum for bulk carrier.

Criteria	OFW Foundations	OFW Turbine	MHK	Comment
Throughput Capacity	30+	30+	30+	The number and rate of turbines constructed.
Vessel Draft	minimum. 38 ft. ideal.	minimum. 38 ft. ideal.	depth minimum. 38 ft. ideal.	Larger carriers up to 38 ft. Demonstration-scale projects will likely use smaller barges.
Number of Deep Draft Berths	1 (minimum) - 2 (ideal)	1	1 (minimum) - 2 (ideal)	Assume deep draft is 25 ft. or greater.
Crane	~500-1000 ton	~500-1000 ton	~500-1000 ton	Dependent on construction procedure and technology. Mobile crane may be sufficient. SPMT to dry dock may be utilized to bypass crane requirement.
Dry dock and Shipyard	Dry dock may be preferred. Width/length varies by technology Spar: ~300 ft. length Semi-Sub: ~175 ft. width TLP: ~175-230 ft. width	Dry dock not required for turbine component fabrication and transport	Dry dock does not appear to be required, though may be beneficial for efficiency.	Demonstration-scale projects may prefer dry dock but not necessarily required.
Other Equipment	Forklifts, crawler cranes, cherry pickers.	Specialized equipment, Forklifts, crawler cranes, cherry pickers, SPMT	Forklifts, crawler cranes, cherry pickers, SPMT.	Blade movements require specialized equipment.
Quayside Bearing Capacity	1000 psf.	1000 psf.	N/A	
Berth Length/ Max Vessel Length	575 ft. berth length /~470 ft. vessel	Device moored appx. >100 ft. from Nav. Channel	575 ft. berth length /~470 ft. vessel	Bulk carrier. Demonstration-scale projects will likely use smaller barges.
Berth Depth/ Max Vessel Draft	28 ft. berth depth minimum. 38 ft. ideal.	25 ft. berth depth minimum. 38 ft. ideal.	25 ft. berth depth minimum. 38 ft. ideal.	Minimum for bulk carrier. Larger carriers up to 38 ft. Demonstration-scale projects will likely use smaller barges.

4.6.3 Assembly Ports

4.6.3.1 Navigation and Berthing

Assembly Ports must have the capability to handle import of constructed components and tow-out of assembled devices to the installation site. Depending on the location and the technology assembly may occur quayside, in dry-dock, or offshore in a sheltered or semi-sheltered deep-water. Table 4-5 and Table 4-6 describe the port facility characteristics assumed to be required to act as an Assembly Port for OFW and MHK, respectively.

Table 4-5. OFW Assembly Port facility criteria

Criteria	OFW			Comment
	Semi-Sub	Spar	TLP	
Throughput Capacity	30+	30+	30+	Assumed commercial-scale
Primary Criteria				
Navigation Channel Width	>=~330-440 ft.	~200-300 ft.	>~300-440 ft.	If berthed quayside, device must have 100 ft. minimum offset from navigation channel.
Navigation Channel Depth	32-39 ft. (conceptual)	~20-30 ft. if assembled at sea (depending on vessel). ~ 300 ft. if assembled in protected waters.	32-39 ft.	
Air Draft	Unlimited	Unlimited	Unlimited	
Area	10-15 acre minimum 50-100 acre ideal	10-15 acre minimum 50-100 acre ideal	10-15 acre minimum 50-100 acre ideal	Assembly only. Depends on size of windfarm.
Secondary Criteria				
Quayside Bearing Capacity	Minimum 1000 psf	Minimum 1000 psf	Minimum 1000 psf	
Crane	1000 ton	1000 ton	1000 ton	
Road/Rail	Highway connection required. Rail preferred.	Highway connection required. Rail preferred.	Highway connection required. Rail preferred.	
Max Vessel Length	~470 ft. vessel	~470 ft. vessel	~470 ft. vessel	

Criteria	OFW			Comment
	Semi-Sub	Spar	TLP	
Throughput Capacity	30+	30+	30+	Assumed commercial-scale
Max Vessel Draft	39 ft. (conceptual)	25 ft. (minimum) 39 ft. (ideal)	Not available	Based on device transit draft (Semi-Sub) and bulk carriers (Spar),
Number of Deep Draft Berths	1-2	1-2	1-2	Deep draft >25 ft.
Other Equipment	Specialized equipment, Forklifts, crawler cranes, cherry pickers, SPMT or marine railway	Specialized equipment, Forklifts, crawler cranes, cherry pickers. SPMT or marine railway	Specialized equipment, Forklifts, crawler cranes, cherry pickers. SPMT or marine railway	Component maneuvering requires specialized equipment.
Skilled Labor Pool and Manufacturing	Skilled Labor needed.	Skilled Labor needed.	Skilled Labor needed.	
Dry dock Use and Width	May be assembled in dry dock. ~175+ ft. width. May also be assembled quayside.	Demonstration project did not use dry dock.	~150-250 ft. width May also be assembled quayside. Dry dock not planned for demonstration project	

Table 4-6. MHK Assembly Port facility criteria

Criteria	MHK	Comment
Throughput Capacity	30+	
Navigation Channel Width	210-300 ft.	Information on Floating Oscillating Water Column device width is conceptual only. Width required may be ~330 ft.
Navigation Channel Depth	25 ft. minimum, 39 foot ideal	Information on Floating Oscillating Water column draft is conceptual only. Depth Requirement may be up to 50 feet for such a device.
Road/Rail	Highway connection required. Rail preferred.	Components will be assembled at the port. Depending on location of fabrication facility, components may be shipped overland via truck or rail.
Secondary Criteria		
Berth Length/ Max Vessel Length	~470 ft. vessel	Bulk carrier
Berth Depth/ Max Vessel Draft	25 ft. (minimum) 39 ft. (ideal)	Bulk carrier. Device specific draft requirements of devices in development may exceed bulk carrier draft. If barges are used instead, draft may be less.

Number of Deep Draft Berths	1	
Crane	500-1000 ton	Depends on Technology
Area	10 acres	Source: ORECCA Report. May differ for specific devices and projects.
Air Draft	150 ft.	Potential bulk carrier air draft requirements. Bulk carrier assumed to move more components on commercial-scale. If barge used instead air draft would be reduced
Other Equipment	SMPT, Forklifts, crawler cranes	Marine railway may also be utilized.
Skilled Labor Pool and Manufacturing	Skilled Labor needed.	

The height of the assembled OFW devices (>600 ft.) does not allow for any bridges or other air draft obstructions seaward of the assembly location. Assembly locations may also occur at private terminals. Semi-Sub and TLP devices will likely be towed out from port fully assembled and therefore the navigation channel must be able to accommodate the draft of the assembled device, the width of the assembled device, and the clear width needed for the wingspan of the blades. Assembly procedure for Spar technology is still in development and specific navigation requirements for the newest developments have not yet been tested in the field. The Hywind demonstration project was assembled in deep water offshore of an assembly port where turbine components were staged, which is the assumption for this study. For this study it is assumed that cable laying vessels will not require access to the Assembly Port.

4.6.3.2 Upland Infrastructure

OFW Assembly Ports must have the capability to store, maneuver, and attach turbine components to the foundation. MHK assembly ports must accommodate component import, have lay-down area for component assembly, and have crane capability to move the device to either a barge or into the water. MHK devices may be fully constructed at the FCP port, but require staging at the AP prior to deployment.

Weight of the components requires a heavy-slab for storage, movement, and staging of the components, likely on the order of 1000 pounds per square foot (psf). Some components may require additional capacity, but actions such as SPMTs or spreaders may be used to mitigate. Other specialized equipment will be required to maneuver the blades and other components.

Assembly of Semi-Subs and TLPs may occur in dry dock if available. Spars may be constructed in dry dock, but due to draft requirements, assembly is not likely (given existing technology). Crane capability will likely need to be on the order of 1000 ton capacity (ideally) to assemble the heavier components (i.e. nacelle) for the scale of turbines anticipated for OFW (6 MW+). Marine railways may be utilized.

Staging and assembly area estimates vary based on review of existing literature and fixed-foundation staging ports. The area will also vary depending on the throughput and proximity to the installation location. It's assumed in this study that a minimum area will be approximately 10-15 acres for assembly and staging, with 50-100 acres as the ideal.

Skilled labor is necessary but not at the same scale as needed for the FCPs. Depending on the assembly location (private/public) labor from the longshoreman unions may be available.

4.6.4 Cluster Ports

In this study Cluster Ports are assumed to typically contain fabrication, construction, staging, and assembly functions. There is additional efficiency in co-locating upland staging and transport requirements that can be utilized by co-locating functions from the FCPs and APs, however, the amount of land required is extensive and may be difficult to find with adequate navigation geometry. The ideal OFW Cluster Port would have no air draft restrictions, deep draft navigation channel (~38 ft.), significant manufacturing capabilities and a large skilled workforce, over 100 acres of upland space available for development, highway and rail connections, a 1000 ton crane, multiple deep draft berths, 1000-2000 psf bearing capacity, a dry dock, and be located near several OFW installation locations. The ideal MHK cluster port would have a deep draft navigation channel, significant manufacturing capabilities, a large skilled workforce, 10-20 acres of upland space available for development, and be located near MHK installation sites. It is assumed that power cable manufacturing will utilize existing facilities, and may require mobilization from outside the project area.

4.7 Summary and Next Steps

Recommended parameters outlined described in this chapter for the QRPs, FCPs, and APs will be used to conduct a gap analysis against facilities currently available on the West Coast. This will include facilities available at public ports as well as private facilities such as dry docks and other shipyards. Specific OFW and MHK projects requirements may differ from what was presented in this report due to the dynamic nature of the industry and very specific needs for each technology type, but information presented in this study is intended to be representative of the expected facility requirements based on available information and the direction of the industry.

4.8 Key Findings

A range of port facility and navigation requirements was developed for OFW and MHK development and the different activities to support the industries. Findings in this assessment will be used to develop the gap analysis and port facility assessment in the following chapter.

Key findings are summarized below:

Primary Findings OFW and MHK

- Depending on the throughput, commercial-scale fabrication facilities may require approximately 10-50 acres or more of upland area, depending on the component and number of components being fabricated on site.
- APs and FCPs will likely accommodate either a deck barge or bulk carrier to transport OFW and MHK components to the Assembly Port, since jack-up vessels are likely not likely to be used.
- A large skilled labor pool is required for commercial-scale OFW and MHK fabrication and construction. Skilled labor is needed at the assembly site as well, but more critical for fabrication and construction. A single fabrication facility could require as many as 1,000 skilled workers.

Primary Findings OFW

- In Europe, the offshore wind turbine foundations and turbine components are typically mobilized directly to the installation location site from the fabrication or construction port using jack-up vessels. The foundations may be constructed at the same port as the wind turbine, but is not required to be staged at the same port.

- Because OFW is most likely to be assembled at port, unlike fixed foundation wind, the port requirements for floating offshore wind have some differences. Instead of requiring large jack-up vessels to assemble the turbines at sea, offshore floating wind turbines will likely be assembled in port and then towed to site. While this reduces the amount of vessel infrastructure required (i.e. no large jack-up vessels), the port should be able to provide adequate infrastructure to assemble the turbine on site, such as a heavy duty crane, assembly area, and deep draft berth, dry dock or marine railway.
- Ports supporting OFW require significant area with high bearing load capacity for staging of the materials. Because of the size of the components, especially for the next generation of 6-8MW+ turbines, direct port access is required from the fabrication facilities. Overland transport restrictions will likely preclude many of the fabricated components from being transported over road or rail due to the size of the components required for 6-8 MW turbines.
- Ports supporting OFW assembly must have no air draft restrictions between the assembly site and the open ocean, with existing assembly technology.
- To assemble OFW components it appears a crane with capacity of approximately 1000 tons at a height of 300 ft. may be required.
- Because the turbine is assumed to be assembled in or near port, navigable waterways must also provide adequate depth and air draft for transport of the assembled device (foundation with turbine affixed) to open sea.
- Quayside bearing capacity of approximately 1000 psf or more appears to be characteristic for staging, storage, and transport of OFW components.
- In order to co-locate commercial-scale OFW fabrication and construction at a Cluster Port could require a significant amount of land (potentially 100+ acres) with bearing capacity above 1000 psf, deep (~38 ft.) draft navigation channel access greater than 300 feet wide, a large skilled workforce, multiple deep draft berths, and a 1000 ton lift capacity. The on-site facilities and cranes would need to be optimized for the type of technology.

Primary Findings MHK

- MHK device installation procedures will vary depending on the technology type. Crainage requirements may differ for each technology type in development.
- Prototype MHK projects have used SPMTs and mobile cranes to transport fabricated components on land.
- Berth bearing capacity analysis relative to specific MHK device loads will need to be conducted
- MHK commercial-scale cluster ports would likely need to have a deep draft navigation channel, significant manufacturing capabilities, a large skilled workforce, 10-20 acres of upland space available for development, and be located near MHK installation sites.

Secondary Findings OFW and MHK

- Minimum navigation channel width for Semi-Subs and TLPs (with turbine affixed, and not affixed) is approximately 300-350 ft., in ideal conditions. Navigable channel width requirements may differ for specific devices and towing operations.
- Floating wind foundation installation procedures are still in the developmental stage. New

technologies may be developed to improve economy and efficiency of installation which could affect the port infrastructure requirements associated with them.

- Transport of OFW and MHK components will likely require self-propelled modular transporters to distribute the loads. Though fabrication and construction ports may be located worldwide, if they are located closer, or at the assembly port, throughput is likely to be higher.
- With existing technology, Spars require approximately 250 ft. of water depth for assembly, which is significantly deeper than most seaports. If the Spar is affixed with the turbine outside the port, the navigation channel geometry required from the port to the installation site will be limited by component transport vessels and installation support vessels rather than the device.

5. Candidate Port Pre-Screening Analysis

5.1 Introduction

In this Chapter, port requirements are short-listed down to a smaller set of criteria for the purpose of conducting a pre-screening analysis in advance of the complete assessment. During the course of the study the pre-screen analysis was conducted in parallel with the vessel and port infrastructure requirements outlined in Chapters 3, and 4. Because of the timing of the work, there are slight differences between the preferred criteria used to group ports in this analysis and the more detailed requirement criteria developed in previous chapters. These differences are due to refinement of the criteria, based in part on the results of pre-screening analysis presented in this chapter. The purpose of the pre-screening analysis is to assist in differentiating the identified port facilities on the Pacific West Coast and Hawaii from each other relative to each of the three port classifications (Assembly, Fabrication and Construction, and Quick Response). The screening analysis results were used to focus subsequent work on those ports which are the most applicable to each port classification. Results of this analysis do not necessarily represent whether or not a port can provide the functions required by the different port functions, but instead guide the analysis to determine how each port should be evaluated, and to what set of criteria.

5.2 Screening Classifications

As outlined in Chapter 2, port functions have been organized relative to three potential port classifications. Each combination of port classification and technology type requires unique consideration. The pre-screening analysis considers the following technologies for each port classification: offshore floating wind (OFW); Spar; Semi-Submersible (Semi-Sub); tension-leg platform (TLP) and; marine hydrokinetic (MHK).

5.3 Preliminary Port Screening Criteria and Database

This section outlines preliminary limiting criteria for navigation access and port infrastructure required to be classified as a quick reaction port (QRP), fabrication and construction port (FCP), and assembly port (AP) for OFW and MHK technologies in the pre-screen analysis. These characteristics were selected as representative port characteristics, which indicate the general capacity of the port. These criteria were developed based on a selection of references and conceptual-level analysis. Preliminary limiting criteria requirements were found to vary between technologies, and as such, have been evaluated differently. The study does not intend to screen ports based on restrictions of a single technology.

The navigation and infrastructure characteristics described in the following sections have been collected for each port within the geographic region of study described in Chapter 2 (California, Oregon, Washington, Hawaii), and have been incorporated into the project database. The data organized specifically for the pre-screening analysis is located in Appendix A. The following sub-sections describe the evaluation criteria and present the preliminary port navigation and infrastructure databases separately. The result of the pre-screening analysis, which cross-references available infrastructure and criteria, is provided on a state by state basis.

5.3.1 Navigation Access

Navigation access characteristics are a critical measure of the port classification each port may be able to provide, and are difficult to mitigate without substantial lost time and re-development if conditions are not met (such as air draft). The following navigation access criteria were developed for use in the pre-screening analysis in order to characterize the available navigation access for each port. Preliminary assumptions for marine transport are required in order to develop the navigation restrictions. Detailed vessel requirements were described in Chapter 2, and will be utilized in the more detailed port assessment. Descriptions of the criteria are listed below in Section 5.3.1.1.

5.3.1.1 Pre-Screening Navigation Access Characteristics

Navigation Depth

This is the representative facility access depth used to estimate restrictions to vessels and device towing. Assumed vessel characteristics to be used in the analysis are shown in Table 5-1. Pre-screen navigation access characteristics

Navigation Width

This is the representative facility access width of facility depth used to estimate restrictions on vessels and device towing. Assumed vessel characteristics to be used in the analysis are shown in Table 5-1. Pre-screen navigation access characteristics

Air Draft

Available air draft limit assembled device towing and potentially vessel access. This includes bridges such as Golden Gate Bridge and other coastal bridges. In some cases a portion of the port may have restricted air draft, but the entrance area of the port does not (i.e., Coos Bay, San Diego). In these cases the air draft restriction is reported as the air draft at then entry to the port, so the port is not screened against criteria which do not apply to the port as a whole. Assumed vessel characteristics to be used in the analysis are shown in Table 5-1. Pre-screen navigation access characteristics

Transit Time to Site

In order to provide quick response to the energy facility, the QRP ports need to be within approximately 2 hours of vessel transit to the site. Typical quick response vessels in Europe have a transit speed of approximately 20-25 knots. Therefore, QRPs should be located within approximately 40 nmi of the project site.

Navigation Access Criteria Summary

Navigation criteria described above are summarized for each port classification and technology type combination in Table 5-1. The navigation criteria outlined in Table 5-1 represent preliminary navigation access requirements in ideal conditions, and is meant at this stage only to focus the study. Values shown in this Table 5-1 should not be interpreted as a final analysis. At this stage in analysis it is assumed that the OFW devices must be fully assembled at or near the AP. Assembly of components at sea and not sheltered in harbor is not assumed to be feasible for the screening analysis due to metocean conditions and depths in the Pacific.

Table 5-1. Pre-screen navigation access characteristics

Port Type	Limiting Vessel/Device	Vessel/Unit Dimensions (Ft)	Navigation Width (Ft)	Navigation Depth (Ft)	Air Draft (Ft)	Transit Time
<u>Quick Reaction</u>	Catamaran Crew Vessel	36 Beam 65 Length Overall (LOA)	100	12	100	40 nautical miles (nmi) (2 hours)
<u>Import/Export And Construction</u>						

Port Type	Limiting Vessel/Device	Vessel/Unit Dimensions (Ft)	Navigation Width (Ft)	Navigation Depth (Ft)	Air Draft (Ft)	Transit Time
OFW	Handysize Vessel	75 Beam 500' LOA	150	30	100- 150	N/A
MHK	Handysize Vessel	75 Beam 500 LOA	150	30	100- 150	N/A
<u>Assembly</u>						
OFW Spar	Spar Device/ Handysize	75 Beam 500 LOA	150	300	650	N/A
OFW Semi-Sub	Semi-Sub Device/Handysize	165 Beam 500 LOA	330	32	650	N/A
OFW TLP	TLP Device/ Handysize	230 Beam 500 LOA	450	32	650	N/A
MHK	MHK device/ Handysize	75 Beam 500 LOA	150	30	100	N/A

5.3.1.2 Port Navigation Access Characteristics

Navigation characteristics for ports in the project area (Navigation Depth, Height, Air Draft, and Proximity to Open Ocean) were collected for ports on the West Coast and Hawaii for cross-reference to the preliminary criteria developed for this analysis. Port data used in the pre-screening analysis is found in Appendix A. Additional port information is required to determine capability at a finer scale, as was outlined in Chapter 2, and is addressed in Chapter 6.

5.3.2 Port Facility Infrastructure

Preferred port facility infrastructure characteristics were evaluated for the pre-screening analysis. Table 5-2 describes the port facility infrastructure evaluation criteria used in the analysis. Descriptions of the criteria are listed below in Section 5.3.2.1

5.3.2.1 Port Facility Infrastructure Criteria

Berth Length

The berth lengths recorded and referenced for the pre-screen analysis are intended to be representative of the facility berths in order to determine capability to moor different size vessels only, and is not necessarily representative of the berth which may be used by an OFW or MHK installation or maintenance vessel. Preliminary vessel assumption for each port class and technology is listed in Table 5-1. Additional berth length may be required for staging areas and or multiple vessels. Ranges of berth length requirements are based on literature review and conceptual level analysis.

Upland Area

For the purposes of pre-screen analysis this is the representative area of potentially available upland area for staging and fabrication based on cursory review of the facility. Potentially available land area is refined in Chapter 6 for assessment purposes. Bearing capacity of quayside areas is critical for the

offloading and loading of components. Ground investigations and strengthening of quaysides may be required at some locations, for component laydown and crainage considerations.

Road and Rail Access

Oversize components may be subject to geometry restrictions during overland rail and road transport. Road/Rail score was determined by assigning a rating to road and rail access types. Class 1 rail is rated as very high, interstate access and Class 3 (Secondary) rail is rated as high, U.S. highway access only is rated as medium, and state roads access only is rated as low.

Dry dock Facilities

Partial or full assembly of device components may be required to occur within a dry-dock facility. OFW assembly may require a dry dock at either the FCP for partial construction or the AP. At this stage ports are rated either high, as having significant dry-dock facilities, and low for smaller dry-docks. If no dry-dock facilities are known at this time to exist, Appendix A indicates this with a “-“ symbol.

Manufacturing Capability and Workforce

A significant skilled labor pool will be required for construction and assembly of the devices. Skilled workforce and manufacturing capability are rated from low to high based on a cursory review of manufacturing capabilities in the area, and the size of the metropolitan area.

Port facility infrastructure criteria described above are summarized for each port classification and technology type combination in Table 5-2. The criteria outlined in Table 5-2 represent preliminary infrastructure requirements, and is meant at this stage only to focus the study. Values shown in this table should not be interpreted as a final analysis.

Table 5-2. Pre-screen port infrastructure characteristics

Port Type	Berth Length (Feet)	Upland Area	Road and Rail Access Rating ¹	Dry-dock Facility	Manufacturing and Workforce Rating
Quick Reaction	~250	1-2 Acres	Medium	None	Medium
Import/Export And Construction					
OFW	500-1000	5-10 Acres	Very High	Preferred	High
MHK	500-1000	2-5 acres	High	Preferred	Medium
Assembly					
OFW Spar	500-1750	10-25 Acres	Very High	Preferred	Medium
OFW Semi-Sub	500-1750	10-25 Acres	Very High	Preferred	Medium
OFW TLP	500-1750	10-25 Acres	Very High	Preferred	Medium
MHK	500-750	2-5 acres	High	Preferred	Medium

¹ Road/Rail score was determined by assigning a rating to road and rail access types. Class 1 rail is rated as very high, interstate access and Class 3 (Secondary) rail is rated as high, U.S. highway access only is rated as medium, and state roads access only is rated as low.

5.3.2.2 Port Facility Infrastructure Database

The port facility characteristics shown in Appendix A were collected for ports on the West Coast and Hawaii for cross-reference to the preliminary criteria developed for the pre-screening analysis shown in Table 5-1 and Table 5-2. Additional port information is required to determine capability with more at a finer scale, as was outlined in Chapter 2, and is addressed in Chapter 6.

5.4 Pre-Screening Analysis and Results

The following sub-sections present the pre-screening analysis and result by state in table format. Results of the analysis identify preliminary port classifications for each port to be considered for detailed evaluation in Section 6. Identification of potential port classification establishes the port classification criteria each port is evaluated against in Chapter 6. Results shown in this section should be interpreted as preliminary analysis results only. Ports were evaluated on a three tier basis, appearing to meet port classification characteristics (“+”), not yet meeting all characteristics but may with mitigation measures (“+/-“), and not appearing to meet characteristics without substation changes (“-“). Ports screened with a “+” or “+/-“ for the different classifications are assessed as a potential port for that classification in Chapter 6. A summary of abbreviations (Table 5-3), and symbols (Table 5-4) is provided below.

Table 5-3. Pre-screening analysis key abbreviations

Ports	Technology
QRP - Quick Reaction Port	OFW - Offshore Floating Wind
FCP - Import/Export & Construction	Semi-Sub – Semi-Submersible OFW supported device
AP- Assembly	TLP – Tension Leg Platform OFW supported device
	Spar – Spar (80m draft) OFW supported device
	MHK – Marine Hydrokinetic devices

Table 5-4. Pre-screening analysis legend

Symbol	Definition
+	Appears to meet Port Classification Characteristics
(+/-)	May be able to meet Port Classification Characteristics, but may require additional site development or mitigating procedures
-	Does not appear to meet Port Classification Characteristics without substantial changes

5.4.1 California

5.4.1.1 Pre-Screen Analysis

The pre-screening analysis for California Ports is shown in Table 5-5.

Table 5-5. California ports pre-screening analysis

California Port	QRP			FCP		AP			Comment
	OFW/MHK	OFW	MHK	Semi-Sub	TLP	Spar	MHK		
San Diego	+	+	+	(+/-)	(+/-)	-	+	Upland Acreage seaward of Coronado Bridge to be confirmed	
Los Angeles	+	+	+	+	+	-	+	Spar requires ~280 ft. depth	
Long Beach	+	+	+	+	+	-	+	Spar requires ~280 ft. depth	
Hueneme	+	+	+	+	+	-	+	Navigation Channel Width may limit TLP	
Morro Bay	+	-	-	-	-	-	-	Limited Navigation Depth and width.	
Oakland	+	+	+	-	-	-	+	Air Draft: Golden Gate Bridge	
Richmond	+	+	+	-	-	-	+	Air Draft: Golden Gate Bridge	
Stockton	-	(+/-)	(+/-)	-	-	-	-	Air Draft: Antioch Bridge (~135 ft.)	
San Francisco	+	+	+	-	-	-	+	Air Draft: Golden Gate Bridge. Dry dock.	
West Sacramento	-	(+/-)	(+/-)	-	-	-	-	Air Draft Benicia Martinez Bridge (~138 ft.)	
Benicia	(+/-)	-	(+/-)	-	-	-	-		
Redwood City	-	-	-	-	-	-	-	Air Draft: Antioch Bridge (~135 ft.). Limited upland Area available	
Humboldt Bay	+	(+/-)	(+/-)	+	+	-	+	Limited overland connections.	

5.4.1.2 Pre-Screen Results

The following subsections present the results for each port type (QRP, FCP, and AP).

Quick Reaction Ports (QRP)

Based on the pre-screening analysis, the following ports are classified as a potential QRP for the purposes of focusing the study:

- San Diego
- Los Angeles
- Long Beach
- Morro Bay

- Hueneme
- Oakland
- Richmond
- San Francisco
- Humboldt Bay

Distance from BOEM waters for the Stockton and West Sacramento ports preclude their use as QRPs (<40 nmi). It should be noted, that although many of the ports located in California can serve as a QRP, many of the ports are focused in one area. There may be regions off the coast of California that are not within 40 nmi of any suitable port, which could require either new infrastructure to be built, or the feasibility of a larger floating service vessel permanently moored near the site would need to be investigated.

Fabrication and Construction Ports (FCP)

Based on the pre-screening analysis, the following are classified as a potential FCP for either OFW or MHK technologies, for the purposes of focusing the study:

- San Diego
- Los Angeles
- Long Beach
- Hueneme
- Oakland
- Richmond
- San Francisco
- Humboldt Bay
- Benicia
- West Sacramento

The ports appear to meet preliminary requirements of labor force, manufacturing ability, supply chain connections, and navigation access to be analyzed as potential FCPs. At Humboldt Bay the supply chain connections will need to be analyzed further to determine if it is a viable port for this need. Its remote location and lack of rail connection may be an issue. Overall, the Bay Area and Southern California may be expected to provide the majority of the import/export, fabrication, and construction services, as ports located here are among the largest in the world.

Assembly Ports (AP)

Based on the pre-screening analysis, the following ports are classified as a potential AP for OFW technologies, for the purposes of focusing the study:

- San Diego
- Los Angeles
- Long Beach
- Hueneme
- Humboldt Bay

These ports are not restricted by air draft for transit of assembled OFW devices, such as is the case for ports in the San Francisco Bay which are affected by the Golden Gate Bridge and as well as other bridge

crossings. San Francisco, Oakland, and Richmond have been classified as potentially providing assembly services for MHK devices as the air draft restrictions will be significantly less for these technologies.

5.4.2 Oregon

5.4.2.1 Pre-Screen Analysis

The pre-screening analysis for Oregon Ports is shown in Table 5-6.

Table 5-6. Oregon ports pre-screening analysis

Oregon Port	QRP	FCP			AP			Comment
	OFW/MHK	OFW	MHK	Semi-Sub	TLP	Spar	MHK	
Brookings	(+/-)	-	-	-	-	-	-	Sufficient nav. depth for QR, but limited berth length
Gold Beach	-	-	-	-	-	-	-	Recreational Marina. Insufficient depths
Port Orford	-	-	-	-	-	-	-	Small Unsheltered Berth
Bandon	-	-	-	-	-	-	-	Recreational Marina.
Coos Bay	+	(+/-)	(+/-)	(+/-)	(+/-)	-	+	Limited overland supply chain connections. Additional land available for development
Umpqua	(+/-)	-	-	-	-	-	-	Sufficient nav. depth for QR, but limited berth area and located 10 nmi inland.
Siuslaw	-	-	-	-	-	-	-	Recreational Marina
Newport	+	-	(+/-)	-	-	-	(+/-)	May be limited on air Draft and ground connections
Toledo	(+/-)	-	(+/-)	-	-	-	-	Located 12 nmi inland. 300 ton dry dock. Services commercial and scientific fleets.
Tillamook Bay	-	-	-	-	-	-	-	Recreational Marina
Garibaldi	(+/-)	-	-	-	-	-	-	Port may be limited by berth length.
Nehalem	-	-	-	-	-	-	-	Recreational Marina
Astoria	+	(+/-)	+	+	+	-	+	Some rail, upland area may limit construction/assembly
St. Helens	-	(+/-)	(+/-)	-	-	-	(+/-)	Limited existing infrastructure. Requires development. Located on Columbia River. Air Draft limited by bridges.
Portland	-	+	+	-	-	-	+	Air Draft limited by bridges on the Columbia River

5.4.2.2 Pre-Screen Results

The following subsections present the results for each port type (QRP, FCP, and AP).

Quick Reaction Ports (QRP)

Based on the pre-screening analysis, the following ports are classified as a potential QRP for the purposes of focusing the study:

- Brookings
- Coos Bay
- Umpqua
- Newport
- Garibaldi
- Astoria
- Newport

Many of the ports located on the Oregon Coast are intended for recreational use or for commercial fishing vessels, and do not meet the needs for quick reaction vessels and infrastructure. The ports listed above will be evaluated more closely to evaluate their existing facilities, and potential improvements required. There may be regions off the coast of Oregon that are not within 40 nmi of any suitable port, which could require either new infrastructure to be built, or the feasibility of a larger floating service vessel permanently moored near the site would need to be investigated.

Fabrication and Construction Ports (FCP)

Based on the pre-screening analysis, the following ports are classified as a potential FCP for either OFW or MHK technologies, for the purposes of focusing the study:

- Coos Bay
- Newport
- Astoria
- St. Helens
- Portland

These ports will be investigated further to determine capabilities to support OFW and MHK technology component import/export and construction. Newport does not have the infrastructure required to support OFW, but may be able to support MHK, depending on the size of the energy farm and device. St. Helens does not currently have the capability to provide as an FCP, but appears to have significant upland acreage for development along the Columbia River. Coos Bay may or may not be able to provide FCP services for OFW and MHK devices due to limited supply chain connections, manufacturing base, and upland area. There is a potential for new terminal development downriver of the bridge at Coos Bay, which is where an OFW terminal may be proposed.

Assembly Ports (AP)

Based on the pre-screening analysis, the following ports are classified as a potential AP for OFW technologies.

- Coos Bay
- Astoria

Many of the ports in Oregon are limited by either size, or air draft restrictions, and are not able to provide the facilities needed for device assembly and tow out. Parts of Coos Bay, downriver of the bridge, may be developed for OFW assembly in order to remove air draft restrictions for device transport via tow. However, navigation width provided at the mouth of Coos Bay may not be sufficient for OFW device tow-out without additional analysis or safety procedures, as the devices may be greater than 150 ft. wide and the navigation channel is twice that width (300 ft.).

The Newport, Portland, and St. Helens areas may be able to provide MHK assembly services since the MHK devices have significantly less air draft restrictions and are not limited by the bridges on the Columbia River.



Figure 5-1. Port of Astoria and Astoria Bridge (Longshore Shipping News 2012)

5.4.3 Washington

5.4.3.1 Pre-Screen Analysis

The pre-screening analysis for Washington Ports is shown in Table 5-7.

Table 5-7. Washington ports pre-screening analysis

Washington Port	QRP	FCP		Semi-Sub	AP			Comment
	OFW/MHK	OFW	MHK		TLP	Spar	MHK	
Vancouver	-	+	+	-	-	-	+	Currently handles land-based wind farm components. Limited by bridges on the Columbia River
Bellingham	-	(+/-)	+	-	-	-	(+/-)	Draft may limit AP for MHK. Limited upland space
Woodland	-	(+/-)	(+/-)	-	-	-	-	Limited existing port facilities, may be developed as Columbia River Port
Kalama	-	(+/-)	+	-	-	-	+	Supply chain connections and berth length. Access to Columbia River
Longview	-	(+/-)	+	-	-	-	+	Supply chain connections and berth length. Access to Columbia River
Ilwaco	-	-	-	-	-	-	-	Limited navigation depth and berth facilities
Grays Harbor	-	+	+	+	+	-	+	Protected harbor, rail connection, upland acreage and no air draft restriction. Dry dock may be available.
Port Angeles	-	(+/-)	+	+	+	-	(+/-)	No Air draft restrictions. No rail or interstate highway connection
Anacortes	-	(+/-)	(+/-)	(+/-)	(+/-)	(+/-)	(+/-)	No Air draft restrictions. No rail or interstate highway connection
Everett	-	+	+	+	+	(+/-)	+	Specializes in over dimensional cargo. No air draft restrictions
Seattle	-	+	+	+	+	(+/-)	+	No air draft restrictions. Dry dock at Port. Skilled workforce available.
Tacoma	-	+	+	(+/-)	(+/-)	(+/-)	+	No air draft restrictions. Skilled workforce available
Olympia	-	(+/-)	+	-	-	-	+	Air draft restriction. Rail and interstate highway connections. May be limited by berth length.

5.4.3.2 Pre-Screen Results

The following subsections present the results for each port type (QRP, FCP, and AP).

Quick Reaction Ports (QRP)

Most QRP facilities will not be located in Washington State, which is outside the criteria of 40 nmi from an installation site. Illwaco is a possibility, but the effort required to cross the Columbia River Bar likely precludes this location as an option

Fabrication and Construction Ports (FCP)

Based on the pre-screening analysis, the following ports are classified as a potential FCP for either OFW or MHK technologies, for the purposes of focusing the study:

- Vancouver
- Bellingham
- Kalama
- Woodland
- Longview
- Grays Harbor
- Port Angeles
- Anacortes
- Everett
- Seattle
- Tacoma
- Olympia

These ports will be investigated further to determine capabilities to support OFW and MHK technology component import/export and construction. Several of these ports already handle wind farm components for transport overland to sites in the state interior (i.e., Vancouver, Everett). Some sites, such as Woodland and Kalama, may not have the existing facility infrastructure to handle OFW devices, but are located on the deep draft Columbia River, and may have the potential to serve as an FCP. Grays Harbor is located in southwest Washington, is approximately 13 miles from the Pacific Ocean 40 miles north of Oregon, and contains a dry dock, Class 1 rail, and significant upland staging area, as well as no air draft restrictions. Pontoons for the State Route (SR) 520 Floating Bridge in Washington were constructed here between 2011-2015, in a 4-acre casting basin, as shown in Figure 5-2.



Figure 5-2. Grays Harbor Casting Basin for SR 520 Pontoons (Washington State Department of Transportation 2013)

Assembly Ports (AP)

Based on the pre-screening analysis, the following ports are classified as a potential AP for OFW technologies, for the purposes of focusing the study:

- Grays Harbor
- Port Angeles
- Anacortes
- Everett
- Seattle
- Tacoma

The ports listed above do not have any air draft restrictions and therefore may be feasible for assembly and transport of fully constructed OFW devices. Because the Puget Sound is able to provide depths greater than 90 m in places, it may be feasible to construct and assemble the Spar technology in protected deep waters offshore of select Washington Ports. Figure 5-3 shows the available depths in the Puget Sound region. Refined analysis will be conducted in later phases of the work to determine feasibility of passage of the Spar through Admiralty Inlet.

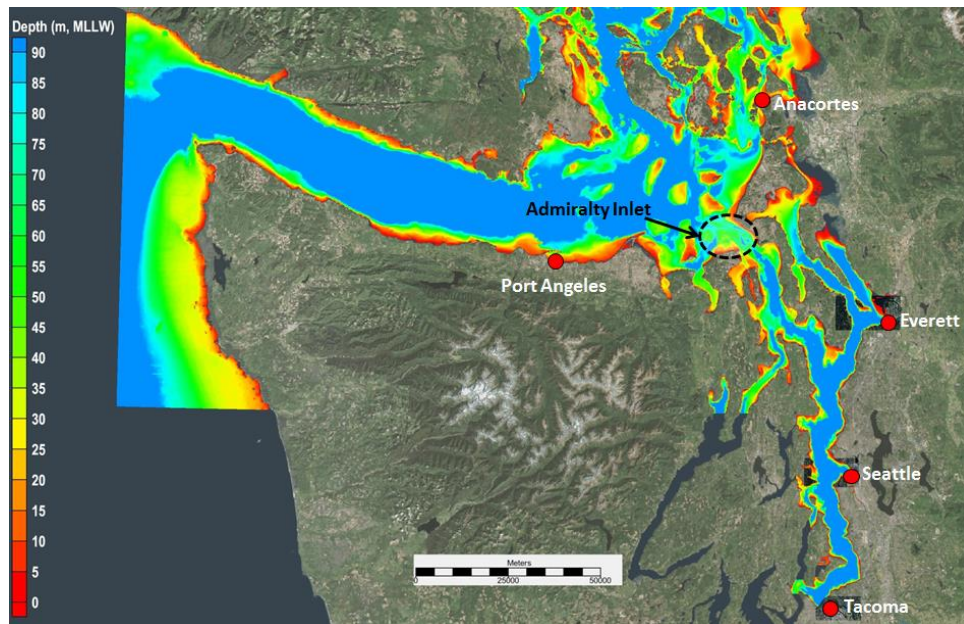

Figure 5-3. Available depths and assembly ports in Puget Sound region (NOAA 2003)

The following ports are classified as a potential AP for MHK technologies, in addition to the OFW classified ports:

- Olympia
- Vancouver
- Bellingham
- Kalama
- Longview

The above ports will be investigated further for their capability to provide as an AP for MHK technology.

5.4.4 Hawaii

5.4.4.1 Pre-Screen Analysis

The pre-screening analysis for Hawaiian Ports is shown in Table 5-8.

Table 5-8. Hawaiian ports pre-screening analysis

Hawaii Port	QRP			FCP		AP			Comment
	OFW/MHK	OFW	MHK	Semi-Sub	TLP	Spar	MHK		
Honolulu	+	+	+	(+/-)	(+/-)	-	+	Largest port in the State	
Barbers Point	+	(+/-)	(+/-)	(+/-)	(+/-)	-	-	Berth length may restrict use	
Kewalo	-	-	-	-	-	-	-	Depth and berth length not sufficient	
Kahului	+	(+/-)	(+/-)	(+/-)	(+/-)	-	(+/-)	Potentially limited fabrication support	
Nawiliwili	+	(+/-)	(+/-)	(+/-)	(+/-)	-	(+/-)	Potentially limited fabrication support	
Port Allen	+	-	-	-	-	-	-	Upland space limitations	

5.4.4.2 Pre-Screen Results

The following subsections present the results for each port type (QRP, FCP, and AP).

Quick Reaction Ports (QRP)

Based on the pre-screening analysis, the following ports are classified as a potential QRP for the purposes of focusing the study:

- Honolulu
- Barber’s Point
- Kahului
- Nawiliwili
- Port Allen

The above ports will be investigated further for the capability to serve as QRPs.

Fabrication and Construction Ports (FCP)

Based on the pre-screening analysis, the following ports are classified as a potential FCP for either OFW or MHK technologies, for the purposes of focusing the study:

- Honolulu
- Kahului
- Nawiliwili

The above ports will be investigated further for the capability to serve as FCPs. Honolulu is the largest port with the most capabilities on the islands by a significant amount, and has over 30 berth facilities. Nawiliwili Harbor serves as the primary commercial harbor for Kaua’i. Kahului Harbor is the only commercial harbor on Maui and handles overseas containers, cruise ships, and inter-island cargo.

Assembly Ports (AP)

Based on the pre-screening analysis, the following ports are classified as a potential AP for OFW and MHK technologies, for the purposes of focusing the study:

- Honolulu
- Kahului
- Nawiliwili

The above ports will be investigated further for the capability to serve as APs.

5.5 Key Findings

The pre-screen analysis classified ports as potentially providing different roles to be assessed in Chapter 6 against more specific criteria. In addition to providing focus to the port assessment), results of this analysis were useful in focusing detailed data collection and communications with Ports. Below are key findings by region.

- Southern California
 - Southern California appears to have several ports meeting cursory level requirements for further investigation of fabrication and construction ports for OFW and MHK.
 - Several ports in Southern California may be able to provide facilities for OFW and MHK assembly, but require further assessment.
- Northern California
 - OFW assembly port capability is limited by the presence of the Golden Gate Bridge, which precludes OFW assembly in the San Francisco Bay.
 - Northern California Southern California appears to have several ports meeting cursory level requirements for further investigation of fabrication and construction supporting OFW and MHK.
- Oregon Coast
 - Many of the ports located on the Oregon Coast are intended for recreational use or for commercial fishing vessels, and do not meet the needs for OFW or MHK development, including quick reaction ports.
 - There may be regions off the coast of Oregon that are not within 40 nmi of any suitable port, which could require either new infrastructure to be built, or the feasibility of a larger floating service vessel permanently moored near the site would need to be investigated.
 - Coos Bay and Astoria are pre-screened as potential QRPs, FCPs, and APs. These are the only ports directly on the coast that are pre-screened as a potential FCP or AP.
- Columbia River
 - Ports along the Columbia River are limited by air draft restrictions (~200 ft.), and are not classified as potential OFW APs, but may be suitable as FCPs.
 - The distance from BOEM waters precludes the ability of the ports to provide quick reaction services to OFW or MHK installations.
- Washington
 - Grays Harbor is classified as a potential FCP and AP, and is connected to the Pacific by a deep-draft navigation channel.

- The Puget Sound has significant opportunity for fabrication, construction and assembly since many of the ports in Washington do not have any air draft restrictions, have a large skilled labor pool, and are in semi-sheltered bays and harbors.
 - Due to available depths, the Puget Sound may be able to accommodate Spar assembly.
- Hawaii
 - Honolulu is the largest port in the state and will be assessed as a potential QRP, FCP, and AP.
 - Nawiliwili Harbor serves as the primary commercial harbor for Kaua'i.
 - Kahului Harbor is the only commercial harbor on Maui and handles overseas containers, cruise ships, and inter-island cargo. Maui is dependent on throughput of good through this harbor.
 - Barbers Point is potentially suitable as an FCP or AP.
 - In general, ports in Hawaii have less available upland space than mainland ports.
- General
 - Bearing capacity of quayside areas is critical for the offloading and loading of components. Ground investigations and strengthening of quaysides may be required at some locations, for component laydown and crainage considerations.

6. Inventory of Pacific West Coast and Hawaii Candidate Port Facilities and Characteristics

Port characteristics on the West Coast and Hawaii have been assessed against the criteria developed in Chapter 4. This chapter summarizes the findings of the detailed port-by-port assessments by region (detailed assessments located in Appendix A). Ports have been scored relative to the capabilities to support OFW and MHK development. The scoring system was developed parameterize port capabilities and to assess ports equally across the study region in order to be able to characterize port capability across the study area. Scores are relative only to the assumptions and criteria developed for this study. Port capabilities relative to specific OFW or MHK projects may differ.

The assessment was conducted according to the potential port classifications identified in Chapter 5. Each port was scored relative to the readiness and future capability to accommodate commercial- and demonstration-scale development offshore floating wind (OFW) and marine hydrokinetic (MHK) technologies for quick reaction port (QRP), fabrication and construction port (FCP), and assembly port (AP) functions, based on an approximation of infrastructure required to accommodate commercial-scale development. The key port facility and navigation characteristics that are strengths and those that are potential limitations, are described within each assessment. In addition, a cursory gap analysis was conducted for each to estimate the types of facilities that would be required to support OFW and MHK development if the port was not scored as such. Both the scores and gap analysis were conducted with respect to existing technology at the time of this study, future installation technology developments (such as modular turbine blades, lighter components) may result in different port characteristics.

6.1 Port Assessments

Each port has been assessed and scored relative to the scoring matrix in Table 6-1 for each port classification and technology type. The primary criteria are first assessed for each port classification. If the port does not meet all of the primary criteria it would receive either a score of a zero or a one. If the primary criteria are not met for commercial-scale projects (which require significant upland area for staging), but smaller demonstration-scale may be feasible by requiring less land, the ports are scored as a “1”. In many cases the port was not assessed for a certain classification because primary criteria were not met in the pre-screening analysis, and these cases are indicated by a gray “-” as the score.

Because of the amount of information developed during the individual port assessments, the existing port characteristics, scoring, and gaps are have been summarized regionally in the following sections. Scoring for OFW FCP ports has been broken down between turbine components and foundation construction since they may occur at different types of port facilities. As previously mentioned, these scores are based on existing technology only, as well as existing port characteristics and strategic plans. Scores are summarized for each region by port.

The scoring is intended to describe the readiness to support, and investment of facility improvements needed to support OFW or MHK development at each port. In demonstration-scale projects OFW turbine fabrication is assumed to be sourced from outside the region, and not necessarily fabricated within the study area. To construct the turbine components (e.g., blades, hub, nacelle), large permanent factories are required and temporary fabrication facilities are not assumed to be economically feasible.

Additional port characteristics not shown in these key characteristics tables are included in 0. Results from this appendix are summarized in Chapter 6.

Table 6-1. Port assessment scoring matrix

Score	Definition
-	Was not assessed based on results of Pre-screening analysis
0	Does not meet primary criteria and is not suitable with existing technology due to not meeting one or more of the primary criteria (e.g. air draft restriction, upland area restrictions)
1	May not meet all primary criteria (such as available upland area), but temporary use of facilities will allow demonstration-scale project (e.g. staging area for 1 device is temporarily cleared at port).
2	Meets primary criteria. Land redevelopment, new purpose built marine terminal or berth required.
3	Meets primary criteria, and some secondary criteria. Moderate level of improvements needed, such as new high capacity (500+ tons) crane, existing berth upgrades, or berth bearing capacity investigation
4	Meets all primary criteria and most if not all secondary criteria. Minimal improvements are needed such as new small cargo crane (<10 tons), warehouses, helipad.

Associated with each score in the detailed assessment of each port, the gaps in key navigation and infrastructure which are likely needed to support the port classification for each technology type are included. For each region, the key gaps in facility characteristics is described which would likely be required to support the commercial-scale OFW and MHK industries. Assigning a score to each region is not appropriate since the port network to support OFW or MHK development could potentially include multiple regions. For example, MHK fabrication in the San Francisco Bay area and assembly in Hawaii.

Port assessments and regional key gaps are included in the following subsections:

- Southern California;
- Northern California;
- Oregon and Northern California Coast;
- Columbia River;
- Southwest Washington; and
- The Puget Sound

For all regions it was found that permanent and floating crane infrastructure would not be able to support OFW assembly requirements. The need is equal across all regions and so is not a focus of the regional gap analysis. Similarly, sheltered deep water with no air draft restrictions is not found anywhere except for the Puget Sound region and is, therefore, not addressed in the gap analysis.

Several assessment assumptions are important to note, and include the following:

- Facilities related to container shipping are not included;
- The assessment of existing port facilities focuses on general, project and breakbulk cargo facilities;
- Because commercial-scale OFW development will require significant upland land to support fabrication, construction, and assembly, the potential for available upland area for development is included;
- Smaller equipment specific to OFW or MHK transport needs is assumed to be included in project specific procurements, and is not assessed; and

- Data sources for port characteristics are based on communication with port representatives, review of port fact sheets, review of port facilities, and direct observation.

6.1.1 Southern California

6.1.1.1 Overview

In the pre-screening analysis Southern California ports were screened as potentially providing ports to support quick reaction, fabrication and construction, and assembly of OFW and MHK devices. The ports in the region are typically accessed by deep navigation channels and are protected from large swell waves on the Pacific Ocean by either breakwaters or natural harbors. Long Beach and Los Angeles are both major container ports, and have large amounts of land, with much of the available land being used to handle throughput. San Diego has significant shipyard facilities and has two marine terminals at the port which handle a mix of cargo. Portions of San Diego Bay and the Long Beach and Los Angeles ports have bridges crossing the navigable waterways.

6.1.1.2 Assessment

Capabilities of Southern California ports to support development of OFW and MHK are summarized in Table 6-2. Scoring summary: Southern California Detailed assessments are located in Appendix A. The significant shipbuilding capability in San Diego, cargo import/export facilities in Los Angeles/Long Beach, and potential for development at Port of Hueneme position Southern California well for OFW and MHK development. Port facilities are located near BOEM waters and will likely be able to provide QRP services, depending on the location of the development. Depending on the dimensions, the shipbuilding facilities in San Diego may be able to support some OFW foundation and MHK device construction, but the facilities are primarily used for defense contracts and cannot necessarily be relied upon to construct devices on a commercial-scale. The total amount of land at the ports of Long Beach and Los Angeles is very high and would likely be able to accommodate fabrication, construction, and assembly of OFW and MHK devices if existing use is repurposed. Presently available upland area is limited due to the high demand for container cargo throughput. Port Hueneme appears to have upland land available, has no air draft restrictions, has multiple deep draft berths, has rail access, and appears to be a good candidate for accommodating OFW and MHK development. Though the Los Angeles and Long Beach ports are major international ports and likely have high quayside bearing capacities to accommodate the large container cranes, berth specific bearing capacity investigations should be conducted, as well as San Diego and Hueneme prior to handling of OFW components. Overall, to support OFW fabrication requirements for multiple component types it is likely that at least some new land development and marine terminal facilities will need to be built; Hueneme may not be able to accommodate fabrication and transport of blades, nacelles, hubs, tower sections, and foundations which would require 100-200 acres of upland area.

Table 6-2. Scoring summary: Southern California

Port Classification	Technology	San Diego	Los Angeles	Long Beach	Hueneme
Quick Reaction	OFW & MHK	4	4	4	4
Fabrication & Construction	OFW Turbine	2	2	2	3
	OFW Foundation	3	2	2	3
	MHK	4	3	3	4
Assembly	OFW Semi-Sub	2	2	2	3
	OFW Tension-leg Platform (TLP)	2	2	2	3
	OFW Spar	-	-	-	-
	MHK	4	3	3	3

Table 6-3. Regional gap analysis: Southern California

Port Classification	Technology	Potential Gap
Quick Reaction	OFW & MHK	No major gaps
Fabrication & Construction	OFW Turbine	Total amount of available land is high, but currently available land is very low at Los Angeles and Long Beach. Upland redevelopment and berth specific bearing capacity investigations should be conducted. .
	OFW Foundation	OFW may require wider dry docks than available in San Diego and use will also be a function of shipyard availability (dependent on throughput). Otherwise purpose-built facilities may be required. At Los Angeles and Long Beach land redevelopment would be required. Berth-specific bearing capacity investigations should be conducted.
	MHK	No major gaps. Berth bearing capacity investigation dependent on technology.
Assembly	OFW Semi-Sub	Terminal re-use at Los Angeles and Long Beach likely required. Channel or berth deepening may be required at Hueneme depending on technology.
	OFW TLP	Identical to Semi-Sub.
	OFW Spar	Depth limitations (may require ~300 ft.) and open ocean swell waves preclude assembly with existing technology in protected waters.
	MHK	No major gaps. Berth bearing capacity investigation dependent on technology.

6.1.2 Northern California

6.1.2.1 Overview

The Northern California ports were screened as potentially supporting OFW manufacturing and construction, and MHK fabrication and construction, and assembly. Air draft heights are limited to 220 ft. or less due to the Golden Gate Bridge, and other bridges crossing waterways. Similar to Southern California, Northern California ports provide high volume cargo throughput and have few navigation restrictions. Ports in the bay are protected from Pacific Ocean swell waves and do not require breakwaters. The total amount of area at Port of Oakland is very high, but is primarily used for container terminals currently.

6.1.2.2 Assessment

Capabilities of Northern California ports to support development of OFW and MHK are summarized in

Table 6-4. Detailed assessments are located in Appendix A. Northern California has a network of ports which have characteristics that may be able to support future OFW and MHK Fabrication and Construction activities. A potential limitation of ports in the San Francisco Bay area is the present availability of developed upland areas which have direct quayside access for transport of the large OFW components. Ports such as Oakland have substantial upland area with marine access, and should it become available for a change in use, these areas would be a good candidate for OFW or MHK fabrication site. Overall, to support OFW fabrication requirements for multiple component types it is likely that at least some upland or terminal redevelopment is required, or marine terminal facilities will need to be built. The dry dock facilities within San Francisco Bay may be able to support OFW and MHK fabrication and are among the largest on the West Coast, but the width may not be large enough to support all OFW technologies. QRPs within San Francisco Bay and Humboldt Bay may have reduced range in the open ocean due to the transit distance from the ports to the Pacific. Though not assessed, the ports of Stockton and West Sacramento may be able to provide FCP functions. Although many of the ports located in California appear to be able to serve as a QRP, many of the ports are focused in one area. There may be regions off the coast of California that are not within 40 nautical miles (nmi) of any suitable port, which could require either new infrastructure to be built, or the feasibility of a larger floating service vessel permanently moored near the site would need to be investigated. Smaller harbors such as Crescent City, Seal Beach, Moss Landing, Half Moon Bay, and Monterey may be suitable as quick reaction sites in addition to those listed in this report.

Table 6-4. Scoring summary: Northern California

Port Classification	Technology	Oakland	San Francisco	Richmond	Benicia
Quick Reaction	OFW & MHK	4	4	4	0
Fabrication & Construction	OFW Turbine	2	2	2	0
	OFW Foundation	2	1	2	0
	MHK	2	3	2	3
Assembly	OFW Semi-Sub	-	-	-	-
	OFW TLP	-	-	-	-
	OFW Spar	-	-	-	-
	MHK	2	2	2	0

Table 6-5. Regional gap analysis: Northern California

Port Classification	Technology	Potential Gap
Quick Reaction	OFW & MHK	No major gaps
Fabrication & Construction	OFW Turbine	Total amount of land is high, but land re-development is likely required since much of upland land areas are already leased. Berth specific bearing capacity investigations may be required.
	OFW Foundation	Though dry-dock facilities are available, OFW may require wider dry docks and use will also be a function of shipyard availability (dependent on throughput). Otherwise purpose-built facilities may be required. Total amount of land is high, but land re-development is likely required since much of upland land areas are already leased.
	MHK	No major gaps. Dry-dock use dependent on throughput. Land re-development may be required since much of upland land areas are already leased.
Assembly	OFW Semi-Sub	Golden Gate Bridge Air Draft (Bay Area)
	OFW TLP	Golden Gate Bridge Air Draft (Bay Area)
	OFW Spar	Golden Gate Bridge Air Draft (Bay Area)
	MHK	No major gaps. Dry-dock use dependent on throughput. Land re-development may be required since much of upland land areas are already leased.

6.1.3 Oregon and Northern California Coasts

6.1.3.1 Overview

Although there are deep draft ports in this region, there are no major international ports. The deep draft ports on the Oregon and Northern California Coasts without air draft restrictions are Astoria, Coos Bay,

and Humboldt Bay. Coos Bay and Humboldt Bay have large protected harbors and land potentially available for development. Astoria is located just seaward of the Astoria-Megler Bridge and has several terminals. As compared to Coos Bay and Humboldt, Astoria has less land available with direct port access. The Coos Bay area has the largest population on the coast with approximately 26,000 people. Newport is a deep draft harbor and is the home for the NOAA Pacific Fleet as well as a commercial fishing harbor.

6.1.3.2 Assessment

Capabilities of Oregon and California coastal ports to support development of OFW and MHK are summarized in Table 6-6. Detailed assessments are located in Appendix A. The Oregon and Northern California Coasts have a network of ports that appear to be able to support MHK construction and assembly, primarily in Coos Bay, Humboldt Bay, and Newport. OFW fabrication and construction appears technically feasible. For example, the Port of Coos Bay owns a significant amount of land with rail access near the water, but is dependent and requires major marine terminal development. There is likely enough land to develop multiple fabrication facilities (nacelle, foundation, etc.) in the region, but the skilled labor pool may not be populous enough to support the amount of fabrication facilities which are needed to support all aspects of OFW. Without the implementation of the Lower Coos Bay Channel Modification project, device transport in and out of Coos Bay may be difficult. OFW Assembly appears feasible at Astoria, but throughput will be limited by terminal acreage available. Humboldt Bay has the upland area and navigation characteristics to support OFW and MHK development, but will require purpose-built upland facilities and berth infrastructure. Overland connections to Humboldt may limit feasibility of a large OFW manufacturing facility. Several ports along the coast can provide QRP services, but there are large areas outside the range of a 2 hour response by QRP vessels between the ports in the Pacific that may limit installation locations. MHK commercial fabrication and assembly could feasibly be supported in Newport without additional significant port infrastructure, but other options on the coast are somewhat limited.

Table 6-6. Scoring summary: Oregon and Northern California coasts

Port Classification	Technology	Astoria	Coos Bay	Newport Toledo	Brookings	Umpqua	Garibaldi	Humboldt
Quick Reaction	OFW & MHK	3	3	4	2	2	2	4
Fabrication & Construction	OFW Turbine	-	2	-	-	-	-	2
	OFW Foundation	-	2	-	-	-	-	2
	MHK	2	2	3	-	-	-	2
Assembly	OFW Semi-Sub	1	2	-	-	-	-	2
	OFW TLP	1	2	-	-	-	-	2
	OFW Spar	0	-	-	-	-	-	-
	MHK	2	2	3	-	-	-	2

Table 6-7. Regional gap analysis: Oregon and California coastal ports

Port Classification	Technology	Potential Gap
Quick Reaction	OFW & MHK	New exclusive use berths and facilities may be required. Facilities are not equally distributed along the coast.
Fabrication & Construction	OFW Turbine	Improvements to un-developed land is likely required. New or modified marine terminal required. Larger labor pool would likely be required in order to provide all manufacturing needs. Limited rail connections may limit supply chain capabilities.
	OFW Foundation	Improvements to un-developed land is likely required. New or modified marine terminal required. Larger labor pool would likely be required in order to provide all manufacturing needs. Limited rail connections may limit supply chain capabilities.
	MHK	Existing facilities may require berth capacity investigations.
Assembly	OFW Semi-Sub	Purpose built facility required (berth, upland development) at deep draft port with no air draft restriction.
	OFW TLP	Purpose built facility required (berth, upland development) at deep draft port with no air draft restriction.
	OFW Spar	Depths preclude assembly in region with existing technology.
	MHK	Existing facilities may require berth capacity investigations.

6.1.4 Columbia River

6.1.4.1 Overview

Ports along the Columbia River are accessed by the 43 ft. deep, 600 ft. wide deep draft Columbia River Navigation Channel. Ports at Vancouver and Portland are both major international ports. Marine traffic between the Pacific and ports upriver must pass under the Astoria-Megler Bridge, with an air draft restriction of approximately 200 ft. The region has a large manufacturing base and capability, as well as a major shipyard in Portland. The widest dry dock on the West Coast is located at Vigor Shipyards in Portland. Several ports along the Columbia have significant land available for re-development.

6.1.4.2 Assessment

Capabilities of Ports along the Columbia River to support development of OFW and MHK are summarized in Table 6-8. Detailed assessments are located in Appendix A. The Columbia River region is well suited to support development manufacturing of OFW and MHK components, with minor or major modifications to existing facilities based on component type. The deep draft navigation channel of the Columbia River, existing infrastructure, labor pool, and available land provide for a good opportunity to support OFW and MHK. Though existing manufacturing is significant, overall, to support OFW fabrication requirements for multiple component types it is likely that at least some new land development and marine terminal facilities will need to be built. The existing dry dock capabilities at Vigor Shipyard, though the widest on the West Coast, may not be wide enough to support all commercial-scale OFW technologies. The region is similar to some of the purpose-built fabrication sites in Europe, which are located on inland waterways where land and workforce is available. It is possible that multiple components could be fabricated at a single facility with a new marine terminal. The bridges crossing the Columbia River preclude assembly of the devices at the ports in this region, given existing technology; as such the ports were not assessed for that function. The ports are located too far inland (i.e., greater than 40 nmi) to serve as QRPs.

Table 6-8. Scoring summary: Columbia River

Port Classification	Technology	Portland	Vancouver	St. Helens	Woodland	Longview	Kalama
Quick Reaction	OFW & MHK	-	-	-	-	-	-
Fabrication & Construction	OFW Turbine	2	3	2	2	2	0
	OFW Foundation	2	2	2	2	2	0
	MHK	3	3	2	2	3	3
Assembly	OFW Semi-Sub	-	-	-	-	-	-
	OFW TLP	-	-	-	-	-	-
	OFW Spar	-	-	-	-	-	-
	MHK	3	3	2	2	3	3

Table 6-9. Regional Gap Analysis: Columbia River.

Port Classification	Technology	Potential Gap
Quick Reaction	OFW & MHK	Distance from Pacific Ocean precludes use as QRP
Fabrication & Construction	OFW Turbine	Land development or re-use of existing facilities is likely required to provide necessary upland area. At existing facilities berth-specific bearing capacity investigations should be conducted.
	OFW Foundation	Dry dock, though widest on West Coast, may not be wide enough for all OFW technology types. Depending on throughput requirements, and device width, a purpose-built marine terminal with developed uplands is likely be required
	MHK	Existing facilities may require berth capacity investigations. Shipyard availability may affect throughput.
Assembly	OFW Semi-Sub	Columbia River Bridge Air Draft precludes assembly with existing technology.
	OFW TLP	Columbia River Bridge Air Draft precludes assembly with existing technology.
	OFW Spar	Columbia River Bridge Air Draft and depths preclude assembly with existing technology.
	MHK	Existing facilities may require berth capacity investigations. Shipyard availability may affect throughput.

6.1.5 Southwest Washington

6.1.5.1 Overview

Major coastal seaports in Washington are limited to Grays Harbor. The Grays Harbor Federal Navigation Channel connects port facilities to the Pacific Ocean, and is dredged regularly. At the port there are several terminals with various levels of land development over approximately 250 acres of land. The port has no air draft restrictions to its main terminals. The port has a marine terminal rail system with access to the terminals. The Washington State Department of Transportation (WSDOT) built and owns a graving dock (~ 175 ft. x 800 ft.) used to construct pontoons for a state highway project, and the facility may be available for sale after the project is completed (WSDOT 2010).

6.1.5.2 Assessment

Along with no air draft restrictions, the significant upland areas with marine access could be developed to support OFW or MHK construction and assembly. To support OFW fabrication requirements for multiple component types it is likely that at least some new land development and marine terminal facilities will need to be built. Navigation channel depth (36 ft. Mean Low Lower Water [MLLW]) may require phasing of device tow-out with favorable tides, or de-ballasting of the devices. Further investigation of the WSDOT graving dock should be conducted to assess viability for re-use as an OFW or MHK assembly facility. In some cases, additional upland infrastructure, such as paved storage areas, may be required. The port has strong rail connections to support OFW and MHK fabrication. Major construction and fabrication projects (State Highway 520 Pontoons) have shown that a large skilled workforce is available.

Table 6-10 Scoring summary: SW Washington

Port Classification	Technology	Grays Harbor
Quick Reaction	OFW & MHK	-
Fabrication & Construction	OFW Turbine	3
	OFW Foundation	2
	MHK	3
Assembly	OFW Semi-Sub	2
	OFW TLP	2
	OFW Spar	0
	MHK	3

6.1.6 Puget Sound

6.1.6.1 Overview

Ports in the Puget Sound region were classed as potentially supporting development of OFW and MHK fabrication, construction, and assembly. In general the ports exhibit good deepwater, protected port facilities with access to upland infrastructure and workforce with no air draft limitations. The Puget Sound has depths up to over 300 ft. The region has a large population and manufacturing base. The two largest ports in the state, Tacoma and Seattle, handle primarily container cargo, but also move breakbulk and project cargo.

6.1.6.2 Assessment

Capabilities of Washington ports, outside the Columbia River, to support development of OFW and MHK are summarized in Table 6-11. Detailed assessments are located in Appendix A. Because of the available labor pool, total land with marine access, and navigation conditions, the Puget Sound has potential to provide support to the development of OFW and MHK facilities. The region could potentially support manufacturing as well as assembly, with devices towed over a longer distances to the installation sites, since towing is potentially more economical than building major infrastructure elsewhere. Existing facilities will likely be able to support MHK development without significant land re-development. Due to the acreage required to support OFW component manufacturing and assembly, it's likely that the available upland areas with deep water access will need to be developed for these purposes, or repurposed from existing uses. Puget Sound regions Ports could be a good option for a prototype development due to the low cost for infrastructure investment combined with good unrestricted navigable access.

Table 6-11. Scoring summary: Puget Sound

Port Classification	Technology	Seattle	Tacoma	Everett	Anacortes	Olympia	Port Angeles	Bellingham
Quick Reaction	OFW & MHK	-	-	-	-	-	-	-
Fabrication & Construction	OFW Turbine	2	3	2	1	-	2	3
	OFW Foundation	2	2	2	1	-	2	1
	MHK	3	4	3	3	3	3	3
Assembly	OFW Semi-Sub	2	2	1	1	-	2	-
	OFW TLP	2	2	1	1	-	2	-
	OFW Spar	2	2	1	1	-	-	-
	MHK	3	3	1	3	0	2	3

Table 6-12. Regional gap analysis: Washington

Port Classification	Technology	Potential Gap
Quick Reaction	OFW & MHK	N/A
Fabrication & Construction	OFW Turbine	Land redevelopment or re-purposing in Tacoma, Seattle, or elsewhere with marine access is likely required to support fabrication.
	OFW Foundation	OFW will require wider dry docks than available in the Puget Sound area. A purpose-built marine terminal with developed uplands is likely be required for foundation construction and deployment.
	MHK	Berth specific bearing capacity investigations is likely required.
Assembly	OFW Semi-Sub	Purpose built facility required (berth, upland development), or major renovations to Terminal 5 at Port of Seattle or elsewhere. Berth specific bearing capacity investigations.
	OFW TLP	Purpose built facility required (berth, upland development), or major renovations to Terminal 5 at Port of Seattle, or Grays Harbor Graving Dock. Berth specific bearing capacity investigations.
	OFW Spar	Assembly in deep protected water may be possible, but would require procurement or long term lease of floating crane.
	MHK	Berth specific bearing capacity investigations likely required.

6.1.7 Hawaii

6.1.7.1 Background

The Port of Honolulu is a major port, is by far the largest port in the state, and handles the majority of the cargo from the mainland U.S. and international locations. The other ports in Hawaii’s network have significantly reduced throughput in comparison, but with some providing services not available in Honolulu. Most of the ports in Hawaii are referred to as “just-in-time” ports, which highlight the quick turnarounds of vessels and heavy traffic through the ports to ensure a constant stream of supplies to the island population and its industries. Though air draft restrictions do not exist on the islands, availability of upland areas at the ports is sparse; with Barbers Point being the exception.

6.1.7.2 Assessment

Capabilities of Hawaiian ports to support development of OFW and MHK are summarized in Table 6-13. Detailed assessments are located in Appendix A. All the Hawaiian ports described in this report are well positioned as QRPs if this region is selected for OFW and MHK energy development. Shipyard facilities located at Pearl Harbor may be able to provide demonstration-scale OFW or MHK construction, but is subject to availability and size of specific technologies. The Port of Honolulu has the navigation parameters to support OFW and MHK, but land with direct port access is very limited, and it would be difficult to find enough land to build permanent exclusive-use facilities in the port. The islands rely heavily on the seaports to transport goods. Additionally, the ports in Hawaii have very limited port land to re-purpose, unlike major international ports on the mainland where currently available land may be limited but total land in use by the port is large. Barbers Point is likely the most attractive candidate for development of assembly and fabrication facilities for both OFW and MHK due to the depth, size of the harbor, and available land. It, however, does not have the upland area to provide for fabrication and assembly for all OFW development stages. Overall, Hawaii will likely be able to provide some manufacturing or assembly services, but will likely rely on manufacturing outside the state as well due to

limited quayside area availability. As Barbers Point appears to be the only port available to support commercial-scale OFW fabrication and assembly or MHK assembly, it would not likely be able to accommodate multiple exclusive use facilities, and the scores presented in Table 6-13 should be considered independent of each other. The remote location requires all supplies and components for OFW and MHK technology having to arrive by ship or air. A large supply of skilled labor outside of Oahu is unlikely. Many, if not all, of the ports also require project specific solutions for handling heavy-lift and project cargoes of the scale associated with current OFW and MHK technology.

Table 6-13. Scoring summary: Hawaii

Port Classification	Technology	Honolulu	Barbers Point	Kahului	Nawiliwili	Port Allen
Quick Reaction	OFW & MHK	4	4	4	4	3
Fabrication & Construction	OFW Turbine	0	2	1	1	-
	OFW Foundation	1	1	1	1	-
	MHK	3	3	1	1	-
Assembly	OFW Semi-Sub	1	2	1	1	-
	OFW TLP	1	2	1	1	-
	OFW Spar	-	-	-	-	-
	MHK	3	3	1	1	-

Table 6-14. Regional Gap Analysis: Hawaii.

Port Classification	Technology	Potential Gap
Quick Reaction	OFW & MHK	No major gaps
Fabrication & Construction	OFW Turbine	Larger labor pool and additional upland areas with marine access would be needed for full fabrication requirements. Likely that import of at least some components are required to assembly location. Total land with marine access is limited.
	OFW Foundation	Purpose-built marine terminal with developed uplands is required, but total land with marine access is limited
	MHK	Berth-specific bearing capacity investigations likely required.
Assembly	OFW Semi-Sub	Major land redevelopment is required for staging. Limited redundancy in potential locations. Limited protected deep water areas. Total land with marine access is limited.
	OFW TLP	Major land redevelopment is required for staging. Limited redundancy in potential locations. Limited protected deep water areas. Total land with marine access is limited.
	OFW Spar	Harbor depths preclude assembly with existing technology.
	MHK	Berth-specific bearing capacity investigations likely required.

7. Key Study Findings and Conclusions

The primary key findings in the study are described in Section 7.1. The key findings are used to develop the study conclusions in Section 7.2

7.1 Key Findings - Ports and Navigation

Because floating offshore wind is most likely to be assembled at port, the port requirements for floating offshore wind have some differences. Instead of requiring large jack-up vessels to assemble the turbines at sea, offshore floating wind turbines will likely be assembled in port and then towed to site. While this reduces the vessel fleet requirements (i.e., no large jack-up vessels), the port should be able to provide adequate infrastructure to assemble the turbine on site, such as a heavy duty crane, assembly area, and deep draft berth, high capacity and potentially a dry dock. Similar to fixed foundation staging ports, the quayside bearing capacity must be adequate (e.g. 1000 psf or greater) to accommodate the point loads from OFW components.

The primary key findings in the study are described in the following sub-sections. The key findings are used to develop the study conclusions in Section 7.2.

7.1.1 OFW and MHK – General Findings

- Available wharf and vessel fleets to support large offshore structure fabrication is generally not as available on the Pacific West Coast as the U.S. Gulf and East Coasts or Europe.
- Commercial- and demonstration-scale developments will likely use different facilities as a result of economies of scale, investment requirements for infrastructure, and availability of upland space relative to requirements.
- The exact vessel fleet for installation work for both OFW and MHK will be dependent on developer technology, vessel availability, economics, timeline requirements, location, proximity to port, and metocean conditions.
- Ports that have excess land and no air draft restrictions, typically have more navigation channel restrictions (e.g., Humboldt, Hueneme, Coos Bay, Grays Harbor).
- Many of the high volume ports in California, Oregon, and Washington have large total port and terminal acreage areas, which could later be re-purposed for OFW or MHK. However, presently available developed land is limited for medium (10+ acre) or large (50+ acre) exclusive use OFW and MHK terminals.
- Inland Columbia River Ports (Portland, Vancouver, St. Helens, Woodland, Longview) and ports in the San Francisco Bay (Oakland, San Francisco, Richmond) are good candidates for supporting manufacturing and fabrication of MHK and OFW, but are not in a position to support OFW assembly due to restrictions on air draft.
- Several Ports along the Columbia River (e.g., St. Helens) have land with marine access available for MHK purpose built fabrication and assembly, with existing deep draft berths.
- Considering presently available non-leased area, the high-volume ports (e.g., Los Angeles, Long Beach, Seattle, Tacoma, Oakland) will likely not be able to serve as a major assembly or fabrication facility port, but may be able to accommodate one or several fabrication facilities as part of a larger port network. However, because the existing terminals have large areas, if they were re-purposed to OFW or MHK the ports could likely provide multiple functions with appropriate crane and wharf bearing capacity improvements.

7.1.2 OFW – Primary and Secondary Findings

7.1.2.1 Primary Findings

- OFW installation requirements at the portside is different than fixed-foundation wind requirements portside. Fixed foundation is typically assembled at sea, where OFW is likely to be assembled at port (semi-sub, TLP).
- Spars may be assembled at sea, but will likely require assembly operations to occur in protected waters with adequate depths, which are not common to the West Coast.
- Offshore wind turbine fabrication requires specialty manufacturing, unless shipped from overseas.
- Offshore wind components for 6 to 8 megawatt turbines are expected to be too large to transport over road or rail and will likely be fabricated where there is access to quayside areas. Therefore, a network of ports may likely need to be developed, with different ports providing different functions; for example, fabrication at a particular port and assembly at another.
- Crainage requirements to support OFW assembly are not currently commonly found on the Pacific West Coast (e.g., ~1000 ton, with lift height of approximately 300 feet), either land or water-based. MHK components will not require the same crainage requirements for assembly as OFW components because MHK components are not required to be lifted and affixed atop a tower and are generally available.
- Quayside bearing capacity to support OFW components is likely a minimum of 1,000 psf, and may require use of Self-Propelled Modular Transporters to distribute loads. 2,000 psf quayside bearing capacity will likely be preferred.
- A large skilled labor pool is required for commercial-scale OFW fabrication and construction.
- Commercial-scale OFW assembly and construction will likely require exclusive use terminals depending on the size of the wind farm development.
- Ports supporting OFW assembly must have no air draft restrictions (i.e., bridges) between the assembly site and the open ocean.
- Many of the high volume ports in California have limited land available for medium (10+ acre) or large (50+ acre) exclusive-use OFW terminals and ports that have excess land and no air draft restrictions typically have more navigation channel restrictions.
- The width of potential future OFW foundations could exceed the maximum width of existing dry docks on the West Coast and Hawaii, necessitating fabrication elsewhere (such as Asia), modification of existing facilities, or construction of new facilities.

7.1.2.2 Secondary Findings

- Ports supporting offshore windfarms in Europe are not necessarily the ports with the highest throughput volume, and may be located in more rural areas to accommodate the requirements for exclusive-use area acreage and quayside bearing capacity. Facilities at these ports appear to be tending towards purpose-built upland development and quayside facilities (e.g. Port Hull, Bremerhaven, Cuxhaven). Similar developments could occur on the Pacific West Coast.
- At the time of this study, no multiple device (e.g. commercial-scale) OFW energy

developments had yet been installed globally. Therefore, no existing industry was available for direct-comparison to facilities in the study area.

- Floating wind foundation installation procedures are still in the developmental stage. New technologies may be developed to improve economy and efficiency of installation which could affect the port infrastructure requirements, and result in different capabilities for existing ports in the study area to support OFW.
- Location of Assembly Ports and Fabrication and Construction Ports is of less importance than access to upland space, infrastructure, and protected harbor. Towing longer distances is feasible and requires less investment in infrastructure and is currently commonplace in other similar industries deploying large offshore floating structures.

7.1.3 MHK Findings

- MHK technology has not advanced to the same level of refinement as offshore wind technologies. Assumptions were required for the types of devices being deployed and new technologies are in continuous development and refinement.
- Ideally all of the MHK supporting functions would occur at the same port (cluster port). However, the cluster port concept requires more land (30+ acres) which also must provide marine access. A port network may be developed instead, with different ports providing different functions. For example, fabrication on the Columbia River, assembly in Coos Bay.
- Though MHK technology components could potentially weigh over 100 tons each, they will not require the same crainage requirements for assembly as OFW since components are not required to be lifted to be affixed atop a tower.
- A large skilled labor pool is required for commercial-scale MHK fabrication and construction.
- Dry-dock and existing fabrication facilities are capable to support most demonstration-scale projects.
- The port network on the West Coast and Hawaii appears capable to support commercial-scale MHK without significant land redevelopment or purpose built marine terminal.

7.1.4 Marine Navigation Assessment

Several major port facilities in the study area are subject to regional restricted air draft, and others are subject to air draft restrictions with in select areas of the ports. Ports with no air draft restrictions are candidates for supporting OFW assembly with appropriate quayside and upland improvements. MHK assembly sites are not likely to be limited by air draft restrictions of the devices.

- Major Ports without any Air Draft Restrictions
 - Hueneme, Humboldt Bay, Grays Harbor, Port Angeles, Bellingham, Everett, Seattle, Tacoma, Anacortes, Honolulu, Barbers Point.
- Major Ports with no regional Air Draft restrictions, but select areas of the port are limited in air draft.
 - San Diego, Los Angeles, Long Beach, Coos Bay
- Regional Air Draft Restrictions
 - San Francisco Bay, Columbia River, Newport (OR)

7.2 Key Findings - Vessels

This section presents a summary of vessel availability and likelihood of use in the study area, and associated key findings. Table 7-1 shows a summary of the vessel fleet assessment to support OFW and MHK. Availability of vessels which are used in similar industries to OFW and MHK development was assessed in Chapter 3, and Appendix D. The potential vessel fleet to support OFW and MHK development was identified in Chapter 4. A selection of representative specialty vessels available on the West Coast and Hawaii was developed, and is included in Appendix K.

Because OFW and MHK specific fleets do not yet exist, and may vary depending on future technology development, not all vessels may be required, or have equal likelihood of being required. The likelihood of use assessment is based on vessel capabilities, required vessel functions described in Chapter 3, existing cargo transport methods observed for prototype industries, and device component characteristics. The availability assessment is based on the findings in the representative database, vessel availability published by the U.S. Department of Transportation Marine Administration (MARAD, 2016), and discussions with marine contractors.

Table 7-1. Vessel fleet assessment to support OFW and MHK

Vessel	Likelihood of Use	Availability (CA, OR, WA, HI)	Comment
Bathymetric Survey Vessel	High	High	Typically available in study area
Research Vessel	High	High	Typically available in study area
Cable Laying Vessel/Barge	High	Low	Most likely will mobilize from outside study area.
Offshore Construction Vessel	Medium	Low	Not typically utilized on West Coast
Multi-Purpose Vessel	Medium	Medium	May require mobilization from outside study area.
Bulk Carrier	High	Medium	Limited U.S. Flagged Bulk Carriers
ABS-Certified Deck Barge	High	High	Many marine transport companies in study area.
Ocean Tug	High	High	Many marine transport companies in study area.
Support Tug	High	High	Many marine transport companies in study area.
Multicat Tug	Low	Low.	Not typically available in U.S. presently, primarily in Europe.
AHT	High	Medium	May require mobilization from outside study area. MPV may also provide service
O&M Mothership	Low	Very low	Likely a purpose-built vessel
Crew Transfer Vessel	High (OFW)	Low	First CTV delivered to East Coast in 2016.
Offshore Service Vessel	High	Medium	Offshore Supply Vessels currently available in CA, and other parts of U.S. Wind-specific offshore service vessels in Europe only.
Crane Barge (100-500 ton)	Low	High	Available in NW and CA. May mobilize from Gulf.
Crane Barge (700-1000 ton)	Low	Medium	Available in NW and CA. May mobilize from Gulf.
Crane Barge (1000+ ton)	Low	Low	Limited availability worldwide for special-use

7.2.1 Vessels – Primary Findings

- Demonstration-scale OFW or MHK energy developments will likely only use the vessel fleet already in use across the U.S. with potentially some limited specialty vessel charters for specific tasks.
- It is unlikely that large scale open ocean installations will utilize floating barges due to vessel motions associated with the typical wave heights and long wave periods present in the Pacific Ocean (typical annual average wave period ~11 seconds, significant wave height ~7-8 ft.).
- Depths at potential installation sites in the project area will likely preclude the use of jack-up vessels, and the wave climate likely precludes the use of other floating cranes on a commercial-scale. It is most likely that OFW devices will be fully assembled at the port facility then towed to site by tugs. Therefore jack-up vessels or barges with spuds would not be needed, and U.S. flagged vessels should be capable of doing all installation activities.
- Current availability of vessels potentially required to support MHK and OFW is varied, as follows:
 - Vessels not presently common to West Coast and Hawaii
 - *Anchor Handling Tugs and Service Vessels*
 - *Offshore- Wind Service Vessels*
 - *Multi-Purpose Vessels*
 - *Crew Transfer Vessels*
 - *Cable-Laying Vessels*
 - *Multicat Tugs*
 - Vessels common on the West Coast and in Hawaii
 - *Bathymetric, geotechnical, and benthic survey vessels*
 - *Coastal, Ocean, and Harbor Tugs*
 - *ABS Certified Barges*
 - *Bulk Carriers*

7.2.2 Vessels – Secondary Findings

- Installation vessel requirements for MHK technology may vary significantly due to significant variations in device geometry between MHK technologies. Vessels presented in this study are intended to be within the same order of magnitude for any MHK project; however, device specific vessels may be constructed for installation of the MHK devices.
- Cable-laying vessels will require mobilization from elsewhere or be purpose built (commercial-scale) for OFW and MHK projects.
- Ocean tugs are available from companies like Foss, Crowley, and Sause Brothers for towing of devices long distances.
- Multi-purpose vessels may provide similar towing services as anchor handling tugs. If mobilized, multi-purpose vessels could potentially serve several purposes for demonstration-scale, and potentially larger, projects.

- The first crew transfer vessels in the U.S. are being constructed for the Block Island Wind Farm development in Rhode Island. It is expected that purpose built CTVs would be constructed for OFW developments in the study area.
- Similar to CTVs, purpose built vessels to service MHK developments would likely be constructed to fit the needs for a commercial-scale MHK development.
- Offshore wind development specific service vessels (used for larger repairs and personnel transfer) are not currently available on the west coast, and would likely need to be purpose built to meet the demand of the high swell conditions in the Pacific. Offshore wind service vessels would not be stationed at QRPs, and would likely be moored at either the AP or FCP. Offshore service vessels not specific to wind development are present on the West Coast and presently service the oil platforms in California

7.3 General Study Conclusions

Ports on the Pacific West Coast and islands of Oahu, Maui, and Kauai have various levels of existing and potential suitability to support OFW and MHK. Although the Pacific West Coast currently has very good Port infrastructure, there is no single Port facility that currently has the infrastructure which would allow the full fabrication, construction and assembly of OFW technology at one location. Commercial-scale development will most likely utilize a network of ports to provide fabrication and assembly support.

Because commercial-scale OFW development requirements would exceed the current capabilities of port facilities, investment in new wharf and upland infrastructure would be required. A majority of these improvements would be related to wharf structures, laydown areas, storage, heavy-load high-reach cranes and potentially dredging of any new berth facilities. Navigation, rail and road access to the mid to major ports and availability of workforce is relatively good for the development of commercial scale project on the mainland U.S. Implementation of demonstration-scale OFW may require the use of port facilities farther away (within or outside the study area) from the installation site to take advantage of existing infrastructure for fabrication and construction then shipped to a more local port facility for final assembly.

Considering existing technology, regional height limits preclude OFW assembly in many areas of the Pacific West Coast, though these regions are still good candidates for supporting offshore renewable technology fabrication. Existing high-volume ports have the total land area to support OFW and MHK, but most of the land is currently in use for other purposes. Terminals may become available for use at a later date at market rates. A greater number of ports can accommodate MHK fabrication and assembly without significant redevelopment as compared to OFW, primarily because less land is anticipated to be required.

Ports in Washington and Southern California could eventually support OFW and MHK fabrication and assembly, due to the large manufacturing bases, deep-draft navigation channels, and no regional height restrictions on marine traffic. However, these ports would likely require either additional terminal development or re-purposing of existing terminals. Ports in Hawaii generally have limited space available for long-term staging, storage, and manufacturing, which likely precludes their capability to support commercial-scale OFW or MHK fabrication.

Port facilities for servicing an operational demonstration- or commercial-scale development would be limited to the nearby coastal areas in which the OFW and MHK facilities are developed to provide the assumed response time of two hours. Port facilities are not uniformly located along the coasts of Oregon and California. For areas outside the maximum distance to a port, use of a large floating tender vessel to provide the necessary support services has been investigated in Europe. The type and size of these vessels

is in development and may require project-specific design to be operational throughout the winter months in the Pacific Ocean due to the very large average wave climate that exists for the study area.

The Pacific West Coast has good availability of marine vessel technologies relative to the existing industries in those areas, but it varies from availability that exist in other areas of the U.S. The marine vessel technologies currently found on the Pacific West Coast have an emphasis on protected water marine construction, vessel shipping industry, and cross-Pacific navigation, but less emphasis on offshore construction, operations, and service. Specialty construction equipment will require large lead time for either mobilization from other regions (Gulf Coast and East Coast) or to be purpose built for a larger commercial scale project. Additionally, the offshore ocean operating conditions are significantly more energetic on the Pacific West Coast on a year-round basis relative to the Gulf Coast or East Coast of the U.S., which will limit the available time periods for both installation and support service operations. Specialty vessels for assembly and installation of OFW or MHK farms have not yet been developed in the U.S. or Europe and may be further limited as a result of Jones Act vessel restrictions prohibiting foreign-flagged vessels. Existing European wind farm installation jack-up vessels may not be available for long-term use in the U.S. as a result of Jones Act vessel restrictions or may not be suitable due to water depths in the study area. Water depths at potential installation sites in the study area and the wave climate likely precludes the use of floating cranes. Therefore, it is most likely that OFW devices will be fully assembled at the port facility then towed to site by tugs. Jack-up vessels or barges with spuds would not be needed, and U.S. flagged vessels should be capable of performing all installation activities.

7.4 Port Classifications Conclusions

In order to provide quick reference to study conclusions relative to specific technologies, the following subsections were developed and provide a brief overview of the port infrastructure capabilities to support each technology and support function.

7.4.1 Quick Reaction

Throughout many reaches on the Pacific West Coast and Hawaii, QRP locations leave gaps in coastline which cannot be reached by vessel in two hours. The wave climate in the Pacific may preclude the feasibility of floating hotels to serve the energy installations with continuous deployment at sea to mitigate the gaps in coverage.

7.4.2 Fabrication and Construction

7.4.2.1 OFW Turbine

The size and weight of 6 to 8 MW wind turbine generator (WTG) components will require fabrication facilities with direct port access, deep draft channels, a skilled workforce, supply chain connections, and significant upland space available for exclusive use operations. Many of the major ports optimize space to maximize throughput and facilities may need to be built either at smaller ports as part of a port network. Facilities to fabricate the different components may be constructed on undeveloped or redeveloped land directly adjacent to new purpose built marine terminals. Demonstration-scale and other early-stage projects will likely import components directly to the assembly port from existing facilities outside the port network since purpose-built facilities are not economical for smaller projects. Likely locations for this type of development are Port Hueneme, the San Francisco Bay area, the Columbia River, Grays Harbor, and the Puget Sound. The larger ports in Southern California could likely support OFW fabrication should land become available. If all the WTG components are fabricated at the same port, up to 100 acres of space or more is required.

7.4.2.2 OFW Foundations

Similar to WTG components, the size and weight of the foundations will require fabrication facilities with direct port access, a skilled workforce, supply chain connections, and significant upland space available for exclusive use operations. Demonstration-scale projects may likely use existing fabrication shops or shipyards, but commercial-scale projects will require long-term commitments, which could require exclusive use construction facilities. Exclusive use facilities will require a significant amount of land (50+ acres). Developed land area of this size with the necessary berth and quayside bearing capacity is not commonly available, or is currently used for another purpose. Available land is more likely to be found at one of the medium-size ports (e.g., Hueneme) or yet to be developed land. The major international ports in California, Oregon, and Washington have the land required for fabrication, but would require re-use of existing terminals. The foundations may be constructed in existing dry docks, but would be limited in throughput if using existing facilities and are limited to approximately 180 ft. in width. Semi-subs and TLPs could potentially be as wide as 230 feet, which would preclude the use of existing dry docks in the project area.

7.4.2.3 MHK

Because MHK fabrication and staging requirements are assumed to require less upland area, more ports have the capability to support the industry with moderate to minimal infrastructure improvements as compared to OFW. Candidate ports that could support MHK fabrication with a moderate level of infrastructure improvements exist in CA, OR, WA and HI, though opportunities in HI appear limited to one port only, as opposed to several ports in CA, OR and WA. Smaller MHK components that can be transported overland can be considered project cargo and served are served by many ports in the study area.

7.4.3 Assembly

7.4.3.1 OFW - Semi-Submersible

Ideally assembly of Semi-sub foundations would occur at the fabrication facility, which requires substantial upland infrastructure and area. No facilities exist in the study area that can currently assemble devices on a commercial scale due to the crainage (1000 ton, 300 ft. height), upland staging area, quayside bearing capacity, and marine navigation requirements. Redeveloped or newly developed land at existing deep draft ports, with construction of a new crane and a high capacity quayside area would be needed to support Semi-sub assembly. In some cases berth dredging would be required. New or re-purposed berths could potentially support assembly in Southern California, the Oregon Coast, Grays Harbor, and Puget Sound. With existing technology and considering the wave climate of the Pacific, assembly of devices in and around the San Francisco Bay area does not appear feasible due to air draft limitations in the bay.

7.4.3.2 OFW – Tension-Leg Platform

Conclusions related to TLP foundation assembly align with Semi-Sub conclusions described above.

7.4.3.3 OFW – Spar Buoy

Existing technology does not allow for assembly of spar devices quayside at any port in the project area. The wave climate of the Pacific Ocean appears to preclude assembly at the installation site area with existing technology. Assembly is potentially feasibly with water-based cranes and staging barges in the Puget Sound since it is protected from ocean swell and typically has depths greater than 300 feet. New installation technology intended to improve existing spar assembly methods is in development.

7.4.3.4 OFW – MHK

Because MHK assembly and staging requirements are assumed to require less upland area, more ports have the capability to support the industry with moderate to minimal infrastructure improvements as compared to OFW. Existing port facilities will likely require new or temporary quayside crane infrastructure, unless the devices are constructed and assembled in dry dock. Bearing capacity of the wharf should be assessed prior to use.

7.5 Current state of Port Infrastructure to support demonstration- and commercial-scale OFW and MHK

In order to provide quick access to the current state of port infrastructure to support future demonstration-scale and commercial-scale developments by region, a brief summary of state-by-state capabilities are summarized below. In all states, additional crane infrastructure at ports appears to be required to support OFW assembly. For demonstration-scale projects land-based mobile cranes can potentially be rented for short-term use.

7.5.1 Demonstration-scale

- **California** – California ports are the largest on the West Coast, and have a good workforce, overland connections, and existing upland infrastructure. Ports in Southern California could support temporary assembly staging. Ports in the San Francisco Bay do not have the capability to support any OFW assembly with existing technology. Humboldt Bay would likely require quayside upgrades in order to support staging and transport of materials.
- **Oregon** – Ports on the Columbia River could be good candidates for supporting manufacturing of OFW foundations, or MHK devices due to capable existing manufacturing facilities, but are not suitable for OFW assembly due to air draft. OFW manufacturing on the Columbia River could be coupled with assembly at one of the Coastal Ports with no air draft restrictions.
- **Washington** – Good deepwater, protected port facilities with access to upland infrastructure and workforce with no air draft limitations. Puget Sound regions Ports could be a good option for a prototype development due to the low cost for infrastructure investment combined with good unrestricted navigable access.
- **Hawaii** – Ports on the island are heavily relied upon for movement of necessary goods from the mainland. Available space is limited, but may be available at Barber’s point. This site could be a good option for prototype development due to navigation access and area available for upland staging. Investigations on available temporary cranes and quayside bearing capacity would be required. Fabrication of devices could also be supported by the shipyard in Pearl Harbor.

7.5.2 Commercial Scale

- **California** – Ports in the San Francisco Bay do not have the capability to support any OFW assembly with existing technology due to air draft restrictions. Humboldt Bay would likely require quayside upgrades in order to support staging and transport of materials. Upland staging area is currently limited in availability at the larger Southern California Ports, but land could potentially be available with re-use of existing terminals. The Port of Hueneme may be able to provide MHK or OFW fabrication, construction, or assembly services.
- **Oregon** – Ports on the Oregon Coast have limited developed upland area available to support assembly staging. New development would be required in Coos Bay to support OFW assembly.

Land for development is available along the Columbia River which could potentially support OFW and MHK fabrication and construction.

- **Washington** – Good deepwater, protected port facilities with access to upland infrastructure and workforce with no air draft limitations. Puget Sound region ports could be a good option for commercial-scale OFW component fabrication, and assembly due to the potential for low-cost infrastructure investment, good unrestricted navigable access, overland connections, and a large skilled workforce.
- **Hawaii** – Limited upland area will likely require at least several OFW or MHK components to be fabricated outside the state. Assembly may be feasible at Barber’s Point but other ports on the islands, including Honolulu, do not have the available upland areas required for staging. There is also limited room available for potential future expansion at the ports.

8. References

- A. Babarit, J. Hals, M.J. Muliawan, A. Kurniawan, T. Moan, J. Krokstad. 2012. *Numerical benchmarking study of a selection of wave energy converters*. Renewable Energy 41 (2012) 44-63.
- AAL Shipping. 2016. *Cargo Overview*. Available online at: <http://aalshipping.com/cargo/>. Accessed November 2015.
- Advanced Research Corporation. 2009. *Wave Energy Infrastructure in Oregon*. Prepared for Oregon Wave Energy Trust. December 1.
- American Bureau of Shipping. 2013. *Guide for Building and Classifying – Floating Offshore Wind Turbine Installations*. Available online at: https://www.eagle.org/eagleExternalPortalWEB/ShowProperty/BEA%20Repository/Rules&Guides/Current/195_FOWTI/Guide. Accessed February 2016.
- American Wind Energy Association. 2015. *Key Definitions*. Available online at: <http://www.awea.org/Resources/Content.aspx?ItemNumber=5839>. Accessed November 6, 2015.
- American Wind Energy Association. 2015. *Ten top trends for wind power in 2014*. Available online at: <http://www.aweablog.org/ten-top-trends-for-wind-power-in-2014/>. Accessed February 2016.
- Axelsson, T. 2008. *Submarine Cable Laying and Installation Services for the Offshore Alternative Energy Industry*. Energy Ocean 2008.
- Bard, J., Thalemann, F. ORECCA N.d. *Offshore Infrastructure: Ports and Vessels, A report of the Off-shore Renewable Energy Conversion platforms – Coordination Action*. Available online at: http://www.orecca.eu/c/document_library/get_file?uuid=6b6500ba-3cc9-4ab0-8bd7-1d8fdd8a697a&groupId=10129. Accessed February 2016.
- BAE Systems. 2016. *Hawaii Ship Repair*. Available online at: <http://www.baesystems.com/en-us/product/hawaiiinbspship-repair>. Accessed February 2016.
- BOW Terminal. 2016. Available online at: <http://www.bowterminal.nl/offshore-and-heavy-lift>. Accessed February 2016.
- Bremenports. 2016. *Bremerhaven Offshore Terminal*. Available online at: http://www.bremenports.de/en/location/the-ports/bremerhaven#project_6. Accessed February 2016.
- Bremenports. 2011. *Offshore Terminal Bremerhaven. Information for Infrastructure Investors*.
- BVG Associates. 2010. *A Guide to an Offshore Wind Farm*. Published on Behalf of the Crowne Estates. Available online at: <http://www.thecrownestate.co.uk/media/5408/ei-a-guide-to-an-offshore-wind-farm.pdf>. Accessed February 2016.

- BVG Associates. 2015. *Virginia offshore wind port readiness evaluation*. Reports 1-3. April, 2015.
- California Department of Transportation (CalTrans). 2007. *Seaports*. Available online at: <http://www.dot.ca.gov/hq/tpp/offices/ogm/seaports.html>. Accessed January 2016.
- C. Slevin, L. Crerar, M. Whelan, R. Hart, E. Doogan. 2012. *Supply Chain for the WestWave Project*. Proceedings of International Conference on Ocean Energy, 2012.
- Columbia Power Technologies. 2016. Available online at: <http://columbiapwr.com/#>. Accessed February 2016.
- D. Martins, G. Muraleedharan. 2015. *Analysis on weather windows defined by significant wave height and wind speed*. Renewable Energies Offshore. Taylor and Francis Group, London.
- Det Norske Veritas AS. 2013. *Design of Floating Wind Turbine Structures. OFFSHORE STANDARD: DNV-OS-J103*. June.
- Det Norske Veritas AS. *Hywind Assembly and Installation Study*. Available online at: <http://innovate.statoil.com/challenges/hywind/Documents/HywindAssemblyAndInstallationStudy.pdf>. Accessed February 2016.
- Det Norske Veritas. 2013. *Offshore Standard: DNV-OS-J103. Design of Floating Wind Turbine Structures*. June. Available online at: <https://rules.dnvgl.com/docs/pdf/DNV/codes/docs/2013-06/OS-J103.pdf>. Accessed February 2016.
- Douglas-Westwood. 2013. *Assessment of Vessel Requirements for the U.S. Offshore Wind Sector – Prepared for the Department of Energy*. Available online at: http://wind.energy.gov/pdfs/assessment_vessel_requirements_US_offshore_wind_report.pdf. Accessed February 2016.
- EDP. WindFloat Project. 2012. *Implementation of a 2 MW Deep Offshore Wind Demonstration Project in Portuguese Waters*. All Energy Conference, Aberdeen, UK. May.
- Eurogate. N.d. *HANDLING OF ON- AND OFFSHORE WIND TURBINES*. Available online at: <http://www1.eurogate.de/en/Products/Wind-energy>. Accessed December 2015.
- European Marine Energy Center. 2011. *Lyness First Client*. Available online at: <http://www.emec.org.uk/emec-lyness-first-client/>. Accessed January 2016.
- Federal Aviation Administration. 2012. Advisory Circular. *Helipad Design*. AC No. 150/5390-2C. April 24.
- Freight Rail Works. 2010. *Class 1 Railroads*. Available online at: <http://archive.freightrailworks.org/network/class-i/>. Accessed February 2016.
- GL Garrad Hassan. 2013. *A guide to UK Offshore Wind Operations and Maintenance*. Scottish

Enterprise and The Crown Estate.

GL Garrad Hassan. 2014. *Assessment of Port for Offshore Wind Development in the United States*. Prepared for the U.S. Department of Energy, Document # 700694-USPO-R-03. March.

GICON-SOF. N.d. *Impressions from development and fabrication*. Available online at: <http://www.gicon-sof.de/en/impressions.html>. Accessed February 2016.

Glosten. 2014. *PelaStar Cost of Energy: A cost study of the PelaStar floating foundation system in UK waters*. January 21. Available online at: <http://www.eti.co.uk/wp-content/uploads/2014/03/PelaStar-LCOE-Paper-21-Jan-2014.pdf>. Accessed February 2016.

Grignon, L., Abend, H., Bacon, D. 2015. *Reducing the cost of offshore wind construction*. EWEA Offshore 2015, Copenhagen, March 10-12, 2015.

Hatch Mott MacDonald. 2015. *Technical Memorandum #1– DRAFT BOEM Ocean Energy On-Call: Task Order #1 Basis of Analysis and Evaluation Criteria*.

Hawaii Department of Transportation. N.d. *A Guide to Port of Hawaii*. Available online at: <http://hidot.hawaii.gov/harbors/files/2012/10/A-Guide-To-Port-Hawaii.pdf>. Accessed February 2016.

AW Hawaii Wind LLC. 2015. *Hawaii Offshore Wind Energy Lease Application Oahu Northwest*. January. Available online at: <http://www.boem.gov/AWH-Northwest-Project-Lease-App/>. Accessed February 2016.

Harland and Wolff. Robin 2010. *Rigg Offshore Wind Farm*. Available online at: <http://www.harland-wolff.com/Projects/Renewable-Energy-Project-Synopsis/Robin-Rigg-Offshore-Wind-Farm.aspx>. Accessed February 2016.

Hywind Scotland Pilot Park. 2015. *Environmental Statement*. April.

Fugro. 2016. *Fugro Symphony*. Available online at: <http://www.fugrosubsea.co.uk/vessels/fugro-symphony/>. Accessed February 2016.

Kinetic Partners. 2011. *Analysis of Maryland Port Facilities for Offshore Wind Energy Services*. Prepared for the State of Maryland. December.

Langlee Wave Power. 2016. *Media Centre* Available online at: <http://www.langleewavepower.com/media-centre>. Accessed February 2016.

Longshore & Shipping News. 2012. *Port of Astoria connects with \$1 million state grant for Pier 2*. June 21. Available online at: <http://www.longshoreshippingnews.com/2012/06/port-of-astoria-connects-with-1-million-state-grant-for-pier-2/>. Accessed February 2016.

Manson Construction (Manson). N.d. *E.P. Paup*. Available online at: <http://www.mansonconstruction.com/ep-paup/>. Accessed February 2016.

- MARAD. 2016. *MARAD Open Data Portal | Maritime Data & Statistics*. Available online at: <http://www.marad.dot.gov/resources/data-statistics/>. Accessed February 2016.
- MarineCadastre.gov. 2015. *An Ocean of Information*. Available online at: www.MarineCadastre.gov. Accessed August 2015.
- Mercury News. 2013. *Left Coast Lifter set to leave Bay Area after Bay Bridge work*. May 28. Available online at: http://www.mercurynews.com/ci_23320626/left-coast-lifter-set-leave-bay-area-after. Accessed February, 2016.
- National Geospatial-Intelligence Agency. 2015. *World Port Index*. 24th edition. 2015.
- Navigant Consulting, Inc. 2013. *U.S. Offshore Wind Manufacturing and Supply Chain Development*. Prepared for the U.S. Department of Energy. February 22. Available online at: https://www1.eere.energy.gov/wind/pdfs/us_offshore_wind_supply_chain_and_manufacturing_development.pdf. Accessed February 2016.
- National Oceanic Atmospheric Administration (NOAA). “U.S. Maritime Limits and Boundaries.” Published September 13, 2013. Accessed August 6, 2015
- NOAA. N.d. *Strait of Juan de Fuca, WA 5 arc-second MHW DEM*. Available online at: <http://www.ngdc.noaa.gov/dem/squareCellGrid/download/655>. Accessed June 2015.
- National Renewable Energy Laboratory. 2015. *MHK Atlas*. Available online at: https://maps.nrel.gov/mhk-atlas/#/?activeLayers=H_Oqyh%2CO_IC_G&baseLayer=groad&mapCenter=40.21244%2C-91.625976&zoomLevel=4. Accessed November 2015.
- Northwest Structural Movers. 2016. *Wave Energy Project*. Available online at: <http://www.nwstructuralmoving.com/projects/wave-energy-project/>. Accessed December 2015.
- Office of Energy Efficiency and Renewable Energy. *The Inside of a Wind Turbine*. Available online at: <http://energy.gov/eere/wind/inside-wind-turbine-0>. Accessed November 2015.
- Offshore Ship Designers. 2015. *Concept design Offshore Wind-Farm Vessel (WMV) launched*. Available online at: <http://www.offshoreshipdesigners.com/news/latest-news/concept-design-offshore-wind-farm-vessel-wmv-launched/>. Accessed December 2015.
- OmniGlobal Group LLC. *OmniGlobal Energy*. Available online at: http://www.omniglobalgroup.com/second%20layer%20pages/omniglobal_energy.htm. Accessed February 2016.
- Oregon Wave Energy Trust. 2009. *Advanced Anchoring and Mooring Study*. November 30. Available online at: <http://oregonwave.org/oceanic/wp-content/uploads/2013/09/Advanced-Anchoring-and-Mooring-Study-November-2009.pdf>. Accessed February 2016.

- Pacific Maritime Magazine. 2015. *Shipyard Directory*. March. Available online at: http://www.pacmar.com/customer_files/specialpubs/PMM_shipyard_directory.pdf. Accessed February 2016.
- Papavizas, C. *The Jones Act and Offshore Wind Farms*. North American Clean Energy, Volume 6, Issue 5.
- Permanent International Association of Navigation Congresses (PIANC). 2002. *Guidelines for the Design of Fender Systems*. Working Group MarCom WG 33, Fendering Guidelines.
- PIANC. 2014. *Harbour Approach Channels Design Guidelines*. Report No. 121-2014.
- BSI British Standards Publication BS6349-4. 2014. *Maritime Structures, Part 4: Code of Practice for Design of Fendering and Mooring Systems*. 3rd Ed.
- Port of Bremerhaven. 2016. *Port Information Guide*. Available online at: <http://www.hbh.bremen.de/sixcms/media.php/13/PORT-INFORMATION-GUIDE-Bremerhaven.pdf>. Accessed February 2016.
- Port of Long Beach. 2016. *Cargo Types*. Available online at: <http://www.polb.com/facilities/maps/cargo.asp>. Accessed January 2016.
- Port of Los Angeles. 2016. *Breakbulk Facilities*. Available online at: <https://www.portoflosangeles.org/facilities/breakbulk.asp>. Accessed January 2016.
- Port of Oakland. 2016. *Terminal Specifications*. Available online at: <http://www.portofoakland.com/maritime/terminal.aspx>. Accessed, January 2016.
- Port of San Francisco. 2016. *Cargo: Breakbulk – Project – Bulk*. Available online at: <http://www.sf-port.org/index.aspx?page=152>. Accessed January 2016.
- Principle Power Inc. 2013. *Unsolicited Application for an Outer Continental Shelf Renewable Energy Commercial Lease: Principle Power WindFloat Pacific Pilot Project*. May 14. Available online at: <http://www.boem.gov/Wind-Float-Lease-Report/>. Accessed February 2016.
- Principle Power. 2014. *WindFloat Pacific OSW Project*. BOEM Workshop Sacramento, CA. July 29.
- Renewable Energy World. 2010. *Marine Energy: Daring to be Different*. April 7. Available online at: <http://www.renewableenergyworld.com/articles/print/volume-13/issue-2/ocean-energy/key-players-marine-energy.html>. Accessed November 2015.
- Seasteading.com. 2011. *Windfarm Mother Ships*. January. Available online at: <http://www.seasteading.org/2011/01/windfarm-mother-ships/>. Accessed December 2015.
- Siemens. 2014. *Siemens D6 Offshore brochure*. April.
- Siemens. 2015. *Ed Davey marks ground-breaking of Siemens Hull development*. Available online at: https://www.siemens.co.uk/pool/news_press/news_archive/2014/siemens-

- b75.jpg. Accessed February 2016.
- Statoil. 2015. *Winners Announced for the Hywind Installation Challenge*. Available online at: <http://innovate.statoil.com/challenges/hywind/pages/winner-announcement.aspx>. Accessed February 2016.
- Sverdrup-Thgeson, J., 2008. *Hywind Demo Project*. December.
- Technip. 2013. *Technip Offshore Finland Construction Yard Facilities*. May. Available online at: https://www.tem.fi/files/37699/Technip_Offshore_Finland-2013_Uutta_liiketoimintaa_merituulivoimasta_lyhennetty.pdf. Accessed January 2016
- Tethys. September, 2014. *Testing of Ocean Energy Buoy at Galway Bay, Ireland*. Available online at: <https://tethys.pnnl.gov/annex-iv-sites/testing-ocean-energy-buoy-galway-bay-ireland>. Accessed February 2016.
- Tetra Tech. 2010. *Port Infrastructure Analysis for Offshore Wind Energy Development*. Prepared for Massachusetts Clean Energy Center. February.
- Thoresen, C. 2003. *Port Designer's Handbook 1st edition*. Thomas Telford Books.
- Vincent S. Neary, Mirko Previsic , Richard A. Jepsen1 , Michael J. Lawson , Yi-Hsiang Yu, Andrea E. Copping , Arnold A. Fontaine , Kathleen C. Hallett , Dianne K. Murray. 2014. *Methodology for Design and Economic Analysis of Marine Energy Conversion (MEC) Technologies*. SANDIA REPORT SAND2014-9040. March.
- Yahalom, S. 2014. *Offshore Wind Development Research*. Sponsors New Jersey Department of Transportation, Federal Highway Administration. April.
- Yemm, R., Pizer P., Retzler, C., Henderson, R., 2012. *Pelamis: experience from concept to connection*. Philosophical Transaction of the The Royal Society. 370, 365–380
- U.S. Army Corps of Engineers. 1999. *Deep Draft Coastal Navigation Channel Practice. Coastal Engineering Technical Note I-63*. March.
- U.S. Army Corps of Engineers. 2006. *Hydraulic Design of Deep-Draft Navigation Projects*. EM110-2-1613. May.
- Washington State Department of Transportation. 2013. *Cycle 3 pontoon construction in Aberdeen*. Available online at: <https://www.flickr.com/photos/wsdot/9603206330/in/album-72157634303311781/>. Accessed February 2016.

Appendix A. Inventory of Pacific West Coast Candidate Port Facilities and Characteristics

Introduction

Analysis presented in this appendix builds on the preliminary database information and analysis which was presented during the pre-screening analysis in Chapter 2. For each port, the facility infrastructure characteristics are presented and assessed relative to infrastructure estimated to be required to support offshore floating wind (OFW) and marine hydrokinetic (MHK) development. At each port, key characteristics are presented as strengths and potential limitations. Not all table cells are populated since key characteristics are different for each port. Additional port characteristics not shown in these key characteristics tables are included in 0, and contributed to the assessment. Ports are assessed and scored relative to their relative readiness to support the various OFW and MHK activities. Scores are summarized in a scoring summary table for each port and classification. The potential gaps between existing facility characteristics and infrastructure needed to support industry development is shown next to the score for each port score. Results from this appendix are summarized in Chapter 6.

Assessment Assumptions

In some cases, multiple sites within a single port are assessed. Facilities related to container shipping are not included. The assessment of existing port facilities focuses on general, project, and breakbulk cargo. Because commercial-scale OFW development will require significant upland land to support fabrication, construction, and assembly, the potential for available upland area for development is included. Small and specialty equipment is assumed to be included in project specific procurements and not assumed to be already available (such as forklifts, etc.). Data sources for port characteristics are based on communication with port representatives, review of port fact sheets, review of port facilities, and direct observation.

A.1. California

A1.1 San Diego

Existing Facilities

The Port of San Diego is a natural deep water harbor located approximately 96 miles southeast of Los Angeles and 10 miles north of the United States-Mexico border. San Diego Bay is protected from the Pacific Ocean by two peninsulas, and the area's temperate climate makes it conducive to year-round cargo handling. It contains a full service shipyard, and two ship repair yards. The port operates two primary cargo marine terminals, Tenth Avenue and National City and specializes in breakbulk cargo (CalTrans 2016). The Tenth Avenue Terminal has previously handled wind farm components such as hubs, blades, and nacelles. To support breakbulk cargo handling and staging the terminal has 25 acres of open space and a 100-ton mobile crane, as well as 24 hour operations. National City Marine Terminal is south of the Coronado San Diego Bay Bridge, which has a clearance of 200 ft. NASSCO General Dynamics and BAE Systems shipyards are also located inland of the bridge. Dry docks at the shipyards have a maximum width of approximately 175 ft., with a lift capability of 650 tons.

Table A-1. San Diego key characteristics

Characteristic	Strength	Potential Limitation
Harbor Location	Sheltered harbor and near BOEM waters	
Navigation	Wide (600 ft) deep navigation channel (~42 ft.)	
Air Draft	Some facilities are seaward of Coronado bridge (~200 ft. clearance)	Shipyards are inland of Coronado bridge (~200 ft. clearance)
Upland Area	135 acres of potential port upland use.	Limited upland area not presently in use for new fabrication facilities with access to the water seaward of the Coronado Bridge.
Crane	650 ton shipyard crane	100 ton mobile crane

Characteristic	Strength	Potential Limitation
Shipyard	Large shipyard	Shipyard is primarily located inland of air draft restriction
Road & Rail Access	Highway access. Class 1 and Shortline Rail access.	
Quayside Facilities		Quayside clear area is limited due to proximity of buildings or existing uses.
Helipad	Airport located near seaport.	
Workforce & Fabrication	Significant manufacturing and shipbuilding capability. Large metropolitan population and manufacturing base.	
Other	Previous experience importing wind turbine components. 24 hour operations	

Assessment

The port is a major harbor and meets many of the criteria for quick reaction port (QRP), fabrication and construction port (FCP), and assembly port (AP) classification for OFW and MHK technologies. Because of the significant shipbuilding capability, San Diego would likely be able to support fabrication and construction of OFW foundations and MHK devices, if the facilities have availability. Shipyard crane capacity would be able to support fabrication of Semi-sub, tension-leg platform (TLP foundations if the devices are narrow enough). Semi-sub and TLP width is expected to be between 140 ft. and 230 ft., so the larger devices would be wider than the dry docks. Spars and MHK devices geometry would likely allow fabrication within the dry dock. Existing crane capability outside shipyard does not meet requirements for wind turbine assembly. Limited (i.e., demonstration-scale) OFW assembly is potentially feasible at Terminal 10, however, quayside staging area appears to be limited and may not provide the necessary space needed for commercial-scale OFW assembly without change in use at the terminal. Land with water access is already highly developed in San Diego Bay, especially seaward of the Coronado Bridge, and though possible, it is unlikely that enough area is available for purpose built fabrication, assembly, or cluster port facilities for OFW, which would be on the order of 50+ acres. MHK assembly is technically feasible at one of the shipyards (BAE/NASSCO). The existing terminals could potentially fit as a QRP, and appear to have adequate upland infrastructure. Purpose built berths for crew transfer vessels (CTVs) may be required. The port could likely also support the larger offshore wind farm service vessels with existing infrastructure (such as berths, upland area, available cranes, etc.).

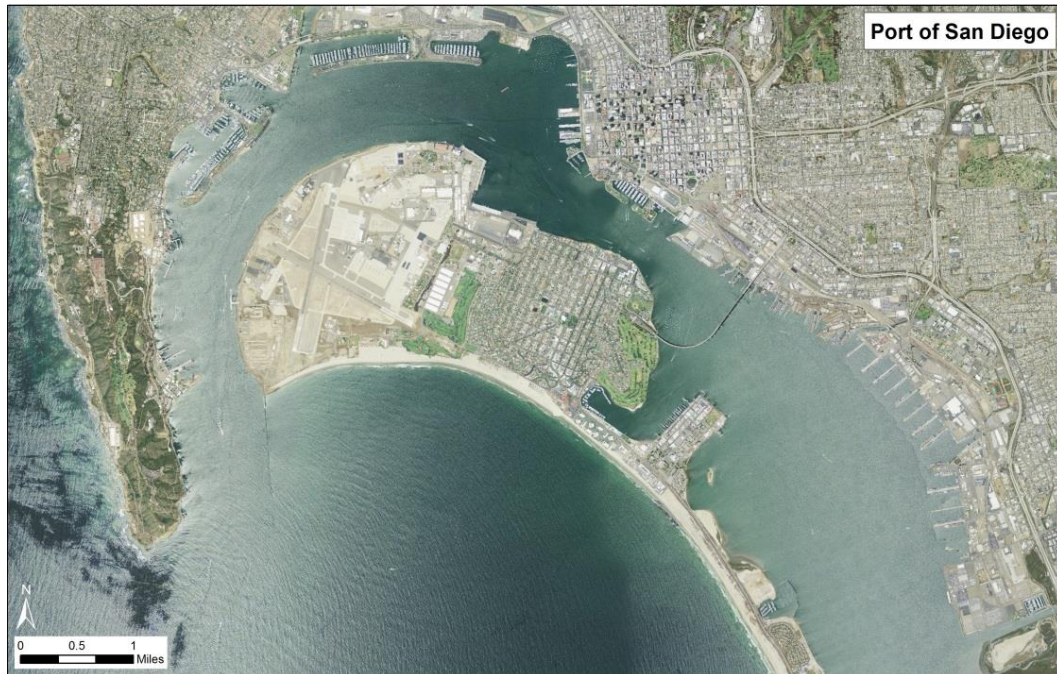

Figure A-1. Port of San Diego

Table A-2. San Diego port assessment and cursory gap analysis

Port Classification	Technology	Score	Potential Gap
Quick Reaction	OFW & MHK	4	No major gaps. Vessel specific moorage may be required.
Fabrication & Construction	OFW Turbine	2	Quayside land (10+ acres) for exclusive use deep draft berth. Requires change in terminal use.
	OFW Foundation	3	Shipyards availability. Wider dry dock or exclusive fabrication terminal (50 acres +) required if wider than ~175 ft.
	MHK	4	Shipyards availability.
Assembly	OFW Semi-Sub	2	Quayside land (10+ acres) for exclusive use deep draft berth seaward of bridge. Requires change in terminal use.
	OFW TLP	2	Quayside land (10+ acres) for exclusive use deep draft berth seaward of bridge. Requires change in terminal use.
	OFW Spar	-	N/A
	MHK	4	Shipyards availability.

- = Was not assessed based on results of Pre-screening analysis.

0 = Does not meet criteria and is not suitable due to not meeting primary criteria.

1 = May not meet all primary criteria for long-term use, but may be used for demonstration –scale projects.

2 = Meets primary criteria. Land redevelopment or purpose-built marine terminal or berth required.

3 = Meets primary criteria, and some secondary criteria. Moderate level of improvements needed.

4 = Meets all primary criteria and most if not all secondary criteria. Minimal improvements needed.

A1.2 Los Angeles

Existing Facilities

The Port of Los Angeles (POLA) is located on San Pedro Bay, 20 miles south of downtown Los Angeles (LA), at the south end of Interstate (I-) 110. The Port is the busiest container port in the U.S. (ranked 1st since 2000) and the 16th busiest container port in the world (CalTrans. 2016). The port has 23 cargo terminals, 270 berths, and 85 gantry cranes over an area of 1600 terminal acres. Of interest to OFW and MHK development, the port operates three (3) breakbulk terminals, with a total of seven (7) berths, and a total of 76 acres (POLA 2016). Existing crane capacity is approximately 45 tons. The Port does not have a major dry dock, though some ship repair facilities are in the area (e.g., Al Larson Boat Shop). The existing breakbulk terminals currently handle steel and are located landward of the Vincent Thomas Bridge, which has a clearance of 184 ft. Expansion of breakbulk facilities is included in the port master plan, but is primarily located inland of the bridge. The port has significant overland connections (Interstates, Class 1 rail, shoreline rail) as a result of the cargo volume handled.

Table A-3. Los Angeles key characteristics

Characteristic	Strength	Potential Limitation
Harbor Location	Sheltered harbor and near BOEM waters	-
Navigation	Deep (53 ft.) and wide (750 ft.) primary navigation channel	-
Air Draft	No regional restrictions	Some areas of the port which may be available are located inland to air draft restriction (184 ft.)
Upland Area	Appx. 1600 total acres	Limited upland area with direct access to the water seaward of the Vincent Thomas Bridge.
Crane	-	45 ton crane
Dry Dock	-	Some shipbuilding and waterside manufacturing facilities.
Road & Rail Access	Class 1 and Shortline Rail access, Interstate access.	-
Quayside Facilities	7 existing breakbulk berths	Quayside berth loading capacity not known.
Helipad	Helipad located at the port	-
Workforce & Fabrication	Large metropolitan population and manufacturing base.	-
Other	24 hour operations	-

Assessment

The port is a major harbor and was classified as potential FCP, AP, and QRP for OFW and MHK. Because the existing breakbulk terminals are located inland of the bridge, OFW assembly at these facilities likely is not feasible due to air draft restriction. Assembly may be feasible seaward of the bridge in the port, but would likely need to displace existing uses and may require project-specific infrastructure development. MHK assembly may be feasible at the port, but will likely require construction or rental of a crane with appropriate lifting capacity. To support fabrication of several components (such as blades, hubs, and towers), additional land may need to be developed. Five acres are currently available at Berths 153-155 (Pasha 2016). Because steel is currently handled at the port, heavy slabs are available for storage and transport may be sufficient for storage of OFW and MHK components. The port appears to have facilities to support CTVs for OFW and MHK. CTVs and offshore wind farm service vessels can both likely be stationed at the port.

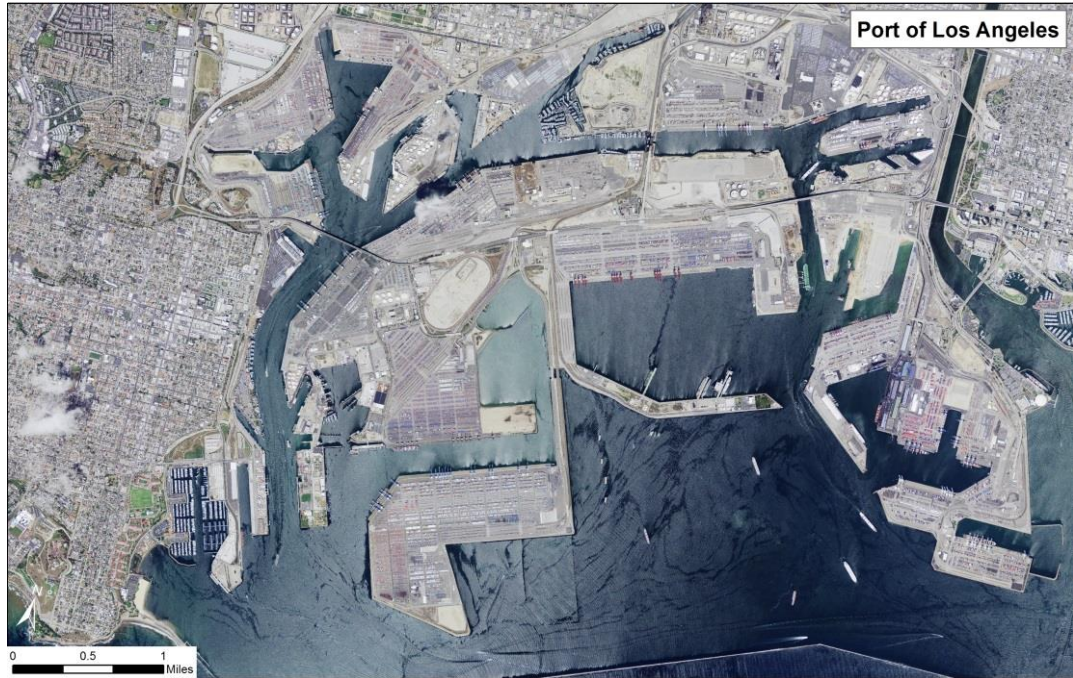

Figure A-2. Port of Los Angeles and Long Beach aerial view

Table A-4. Los Angeles port assessment and cursory gap analysis

Port Classification	Technology	Score	Potential Gap
Quick Reaction	OFW & MHK	4	No major gaps. Vessel specific moorage may be required.
	OFW Turbine	2	Quayside land (10+ acres) for exclusive use deep draft terminal seaward of bridge. Requires change in terminal use.
Fabrication & Construction	OFW Foundation	2	Quayside land (50+ acres) for exclusive use deep draft terminal seaward of bridge. Requires change in terminal use.
	MHK	3	Fabrication facility (1-5 acres). Crawler cranes may be required. Water access may not be required.
Assembly	OFW Semi-Sub	2	Quayside land (10+ acres) for exclusive use deep draft terminal seaward of bridge. Requires change in terminal use.
	OFW TLP	2	Quayside land (10+ acres) for exclusive use deep draft terminal seaward of bridge. Requires change in terminal use.
	OFW Spar	-	N/A
	MHK	3	10 acre facility with new crane.

- = Was not assessed based on results of Pre-screening analysis.

0 = Does not meet criteria and is not suitable due to not meeting primary criteria.

1 = May not meet all primary criteria for long-term use, but may be used for demonstration –scale projects.

2 = Meets primary criteria. Land redevelopment or purpose-built marine terminal or berth required.

3 = Meets primary criteria, and some secondary criteria. Moderate level of improvements needed.

4 = Meets all primary criteria and most if not all secondary criteria. Minimal improvements needed.

A1.3 Long Beach

Existing Facilities

The Port of Long Beach (Port) is located at the south end of the I-710 Freeway and approximately 25 miles south of downtown LA. It has one of the deepest harbors of any seaport in the world and handles approximately 5,000 vessel calls a year (CalTrans 2016). The port is located directly adjacent to the Port of Los Angeles. Five breakbulk terminals are located at the Port, two (Pier F, Pier T) of which are located seaward of the Gerald Desmond Bridge (clearance of 155 ft.). Existing breakbulk crane capacity is approximately 40 tons.

Table A-5. Long Beach key characteristics

Characteristic	Strength	Potential Limitation
Harbor Location	Sheltered harbor and near BOEM waters	-
Navigation	One of the deepest harbors in the world (76 ft.)	-
Air Draft	Appx. 1600 total acres	Several terminals located inland of air draft restriction (155 ft.)
Upland Area	-	Limited undeveloped upland area for new fabrication facilities with access to the water.
Crane	-	40 ton crane
Shipyard	-	Minor shipbuilding and waterside manufacturing facilities.
Road & Rail Access	Interstate Highway and Class 1 rail	-
Quayside Facilities		-
Helipad	Located at Port	-
Workforce & Fabrication	Large metropolitan population and manufacturing base.	-
Other	Experience with wind turbine components	-

Assessment

The port is a major harbor and was classified as potential FCP, AP, and QRP for OFW and MHK. Because of the significant vessel traffic the port already accommodates, few to no navigation restrictions will likely be present. The significant road and rail connections would be able to provide the necessary overland connections for fabrication and assembly support. Limited vessel fabrication is available in this area and may limit experience and available facilities for construction of OFW foundations, and MHK devices. Because the port currently handles a large volume of containers and other cargo, space is limited for new fabrication facilities (requiring over 10 acres each), and foundation construction facilities (~50 acres). The port has significant amount of land that, if repurposed, could support OFW and MHK manufacturing and assembly. The existing crane capacity is not sufficient for handling wind turbine components for 6 MW devices or larger, or for assembly of wind turbines.

Table A-6. Long Beach port assessment and cursory gap analysis

Port Classification	Technology	Score	Potential Gap
Quick Reaction	OFW & MHK	4	No major gaps. Vessel specific moorage may be required.
	OFW Turbine	2	Quayside land (10+ acres) for exclusive use deep draft terminal seaward of bridge. Requires change in terminal use.
Fabrication & Construction	OFW Foundation	2	Quayside land (50+ acres) for exclusive use deep draft terminal seaward of bridge. Requires change in terminal use.
	MHK	3	Fabrication facility (1-5 acres). Crawler cranes may be required. Water access may not be required.
Assembly	OFW Semi-Sub	2	Quayside land (10+ acres) for exclusive use deep draft terminal seaward of bridge. Requires change in terminal use.
	OFW TLP	2	Quayside land (10+ acres) for exclusive use deep draft terminal seaward of bridge. Requires change in terminal use.
	OFW Spar	-	N/A
	MHK	3	10 acre facility with new crane.

- = Was not assessed based on results of Pre-screening analysis.

0 = Does not meet criteria and is not suitable due to not meeting primary criteria.

1 = May not meet all primary criteria for long-term use, but may be used for demonstration –scale projects.

2 = Meets primary criteria. Land redevelopment or purpose-built marine terminal or berth required.

3 = Meets primary criteria, and some secondary criteria. Moderate level of improvements needed.

4 = Meets all primary criteria and most if not all secondary criteria. Minimal improvements needed.



Figure A-3. Port of Long Beach map

A1.4 Hueneme

Existing Facilities

Port of Hueneme is the only deep draft harbor between Los Angeles and San Francisco Bay. The Ports specializes in handling automobiles, produce, and bulk cargo. It also provides support services for the offshore oil industry. (CalTrans 2106). The port has 6 deep draft berths, which appear to be supported by concrete piles, and handles break bulk cargo at the south terminal. It is known as a handler of automobiles and fresh produce. The port has outdoor storage capacity of 50 acres, 165 acres of maritime operations, and 210 acres of industrial land. Shortline rail access is available at the port, but not direct to dock. The port can handle vessels up to 800 ft. in length. At present, it has approximately 130 acres up for commercial lease and 280 acres in additional private parcels. In 2013 Ports America, a terminal operator at the port purchased a LHM 420 mobile harbor crane with a maximum lifting capacity of 136 tones and a radius of approximately 150 ft. Existing cargo storage bearing capacity appears to be approximately 600 psf (findthedata 2015). Presently the navigation channel is maintained at 35 ft. mean lower low water (MLLW), and is planned for deepening to 40 ft.

Table A-7. Hueneme key characteristics

Characteristic	Strength	Potential Limitation
Harbor Location	Sheltered harbor and direct ocean access	-
Navigation	-	35 ft. MLLW navigation depth
Air Draft	No air draft restrictions	-
Upland Area	Over 100+ acres of land available for lease	-
Crane	110+ ton crane	-
Shipyard	-	-
Road & Rail Access	Shortline Rail access	No direct highway access
Quayside Facilities	Multiple deep draft berths	Quayside berth loading capacity investigation may be required.
Helipad	Helipad located near the port	-
Workforce & Fabrication	Large metropolitan area to draw from	Few shipbuilding and waterside manufacturing facilities.
Other	Experience with wind turbine components	-

Assessment

The port was classified as potential FCP, AP, and QRP for OFW and MHK. Because of the large amount of leasable land that appears to be available, no restrictions on air draft, and deep draft navigation, Port of Hueneme is a good candidate to support fabrication, construction, assembly, and operations of floating offshore wind farms and marine hydrokinetic technologies. Purpose built facility construction would be required with water access for fabrication, construction, and assembly and bearing capacity of the berths and storage areas may need to be improved to support OFW. Blade handling may be difficult depending on location of facility if importing from fabrication facility. Channel depth dimension may restrict tow out operations to high tide conditions only, but may be remediated by the planned channel-deepening project. Because the south channel is approximately 400 ft. wide, staging an OFW foundation in this area would likely not allow any other operations in the channel.

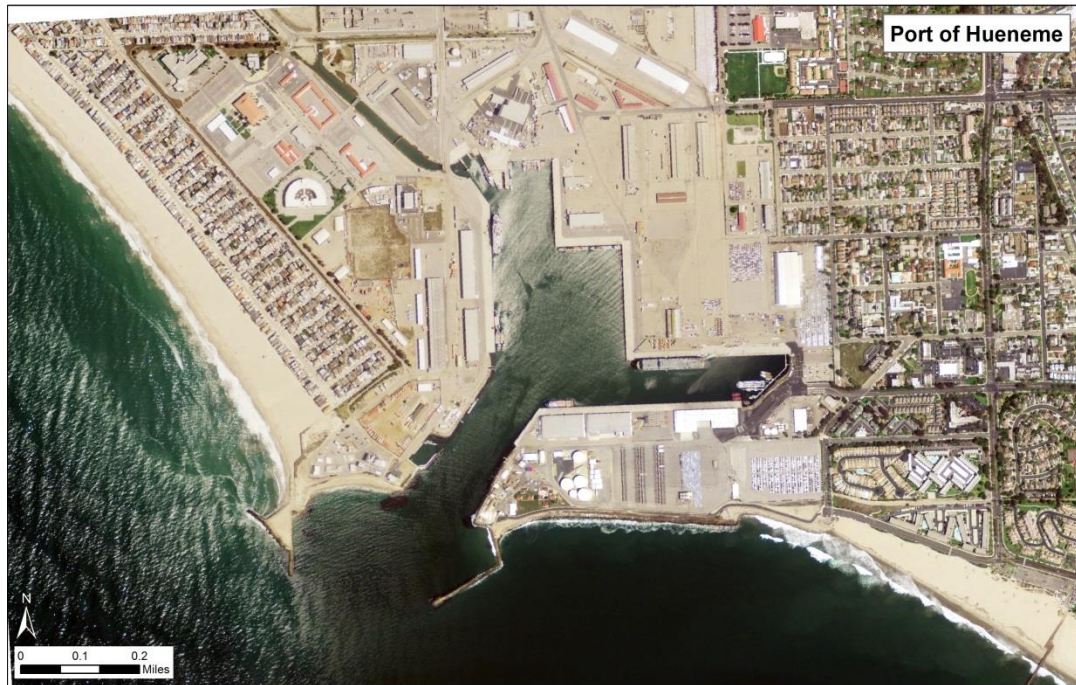

Figure A-4. Port of Hueneme

Table A-8. Hueneme port assessment and cursory gap analysis

Port Classification	Technology	Score	Potential Gap
Quick Reaction	OFW & MHK	4	No major gaps. Vessel specific moorage may be required.
	OFW Turbine	3	Crane capacity improvements may be required. Quayside bearing capacity investigation.
Fabrication & Construction	OFW Foundation	3	Crane capacity improvements may be required. Quayside bearing capacity investigation.
	MHK	4	Fabrication facility (1-5 acres) may not be required to be on water. Quayside bearing capacity investigation.
Assembly	OFW Semi-Sub	3	Exclusive use of 1-2 berths. Crane capacity improvements. Quayside bearing capacity investigation.
	OFW TLP	3	Exclusive use of 1-2 berths. Crane capacity improvements. Quayside bearing capacity investigation.
	OFW Spar	-	N/A
	MHK	3	Crane capacity improvements may be required.

- = Was not assessed based on results of Pre-screening analysis.

0 = Does not meet criteria and is not suitable due to not meeting primary criteria.

1 = May not meet all primary criteria for long-term use, but may be used for demonstration –scale projects.

2 = Meets primary criteria. Land redevelopment or purpose-built marine terminal or berth required.

3 = Meets primary criteria, and some secondary criteria. Moderate level of improvements needed.

4 = Meets all primary criteria and most if not all secondary criteria. Minimal improvements needed.

A1.5 Port of Oakland

Existing Facilities

Port of Oakland is the largest port in San Francisco Bay by volume, and is located on the east side of San Francisco Bay, approximately 16 nmi from BOEM waters, inland of the Golden Gate Bridge (220 ft. clearance). Because it is a major container port; most berths are designed for container cargo. The Port is dredged to a depth of 50 feet annually, and has 1300 acres of maritime area over seven marine terminals, and 20 deep water berths. The Union Pacific and BNSF railroad facilities are located adjacent to the marine terminal facilities. Presently the 18.5 acre, 700 ft. long, Berth 33 is available for lease (Port of Oakland 2016), and has previously handled breakbulk cargo (seaport.findthedata.com 2016). In February 2016, Ports America terminated their lease at the 200+ acre Outer Harbor Terminal. Oakland port officials also said they'd consider other uses for the soon-to-be-vacant terminal apart from container operations (Wall Street Journal 2016). There does not appear to be a helipad at the port or in the vicinity. The Left Coast Lifter crane barge had been used to construct the Bay Bridge, and is now located in New York State after being moored at Pier 7 at the Port of Oakland (Mercury News, 2013)

Table A-9. Oakland Key Characteristics

Characteristic	Strength	Potential Limitation
Harbor Location	Sheltered harbor	-
Navigation	50 ft. dredge depth, accommodates major container ships.	-
Air Draft	-	San Francisco Bay Bridge (190 ft.)
Upland Area	200 acres may be available for redevelopment.	Existing quayside area is limited and used primarily for container throughput.
Crane	-	Primarily container cranes
Shipyard	-	Significant dry docks not on site.
Road & Rail Access	Interstate Highway and Class 1 Rail	-
Quayside Facilities	Multiple deep draft berths	-
Helipad	-	-
Workforce & Fabrication	Large workforce population to pull from	Few shipbuilding and waterside manufacturing facilities.
Other	Potentially large (200+ acre) facility for repurpose from container use.	Historically a container port

Assessment

The Port of Oakland was classified as a potential QRP for OFW and MHK, a FCP for OFW and MHK, and an AP for MHK. The Port was not developed with the intent to handle large quantities of breakbulk cargo or manufacturing on site. Supporting a new industry would be a significant shift from existing operations. The port could feasibly support construction and some fabrication, especially if the Ports America Terminal is repurposed, but it would be a major change in the type of operations that are conducted at the port. Due to air draft restrictions of the Bay Bridge and the Golden Gate Bridge, assembly of OFW devices is not possible in the San Francisco Bay Area. Assembly of MHK devices could occur, but may require purpose built facilities and a new crane. It is not ideally suited to be a QRP since it is located almost an hour (via boat) to BOEM waters but could serve wind farms outside the San Francisco Bay to reach ocean energy sites within 2 hours.

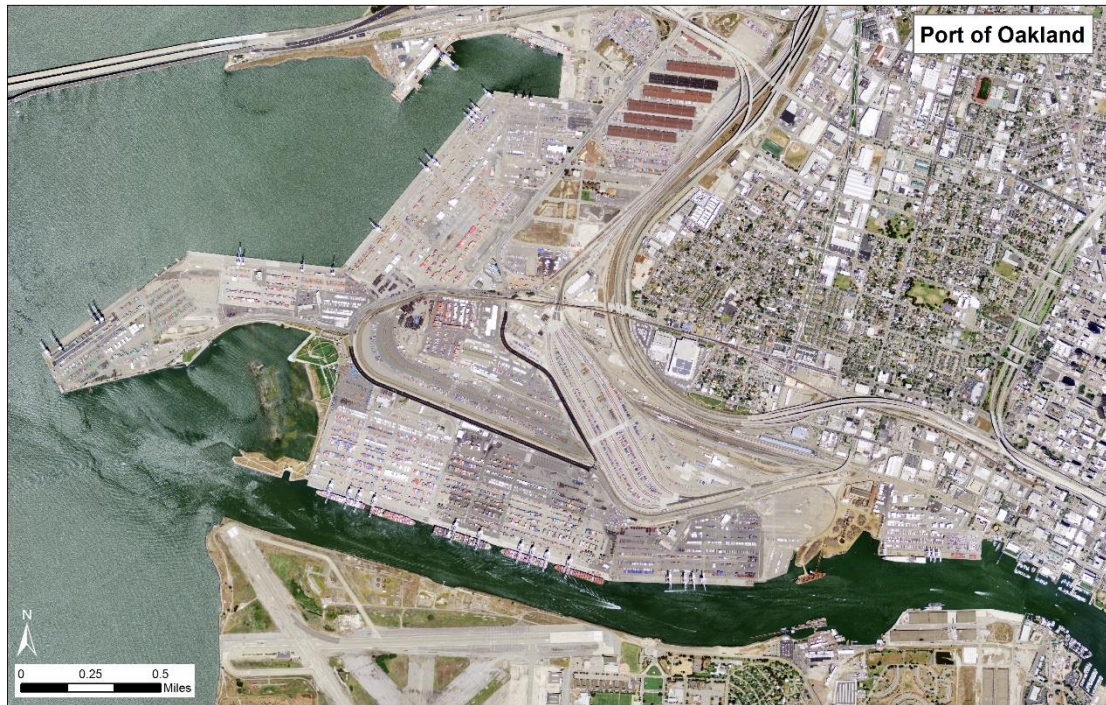

Figure A-5. Port of Oakland

Table A-10. Oakland port assessment and cursory gap analysis

Port Classification	Technology	Score	Potential Gap
Quick Reaction	OFW & MHK	4	No major gaps. Vessel specific moorage may be required.
	OFW Turbine	2	Requires major change in type of operations conducted at Port. Quayside bearing capacity investigation. Crane capacity improvements.
Fabrication & Construction	OFW Foundation	2	Exclusive fabrication terminal. Quayside bearing capacity investigation. Crane capacity improvements.
	MHK	2	Fabrication facility (1-5 acres), may not be required to be on water. Quayside bearing capacity investigation. Purpose built facility.
Assembly	OFW Semi-Sub	-	N/A
	OFW TLP	-	N/A
	OFW Spar	-	N/A
	MHK	2	Requires major change in type of operations conducted at Port. Facility redevelopment with water access with new crane.

- = Was not assessed based on results of Pre-screening analysis.

0 = Does not meet criteria and is not suitable due to not meeting primary criteria.

1 = May not meet all primary criteria for long-term use, but may be used for demonstration –scale projects.

2 = Meets primary criteria. Land redevelopment or purpose-built marine terminal or berth required.

3 = Meets primary criteria, and some secondary criteria. Moderate level of improvements needed.

4 = Meets all primary criteria and most if not all secondary criteria. Minimal improvements needed.

A1.6 Port of Richmond

Existing Facilities

The Port of Richmond is a deepwater port located approximately nine miles from the Golden Gate Bridge in Contra Costa County on the east shore of the San Francisco Bay at the end of Canal Boulevard in South Richmond. The port is accessible through the 38 ft. deep Richmond Harbor Channel. Currently, the port ranks #1 in liquid bulk and automobile tonnage among the five ports on the San Francisco Bay. The port has five city-owned terminals and ten privately owned terminals for handling bulk liquids, dry bulk materials, vehicle and break-bulk cargoes. The port does not handle containers (CalTrans 2016). The port has interstate highway access, shortline rail, and Class 1 rail Access. There are 5 public terminals and 10 private terminals over 200 acres, and 32 miles of shoreline. Pt. Potero Marine Terminal has approximately 130 acres of land, a concrete wharf and pier, multiple berths, two warehouses, and multiple graving docks (four docks measuring 575 ft. x 100 ft. and one dock measuring 750 ft. x 100 ft.). The graving docks are currently flooded.

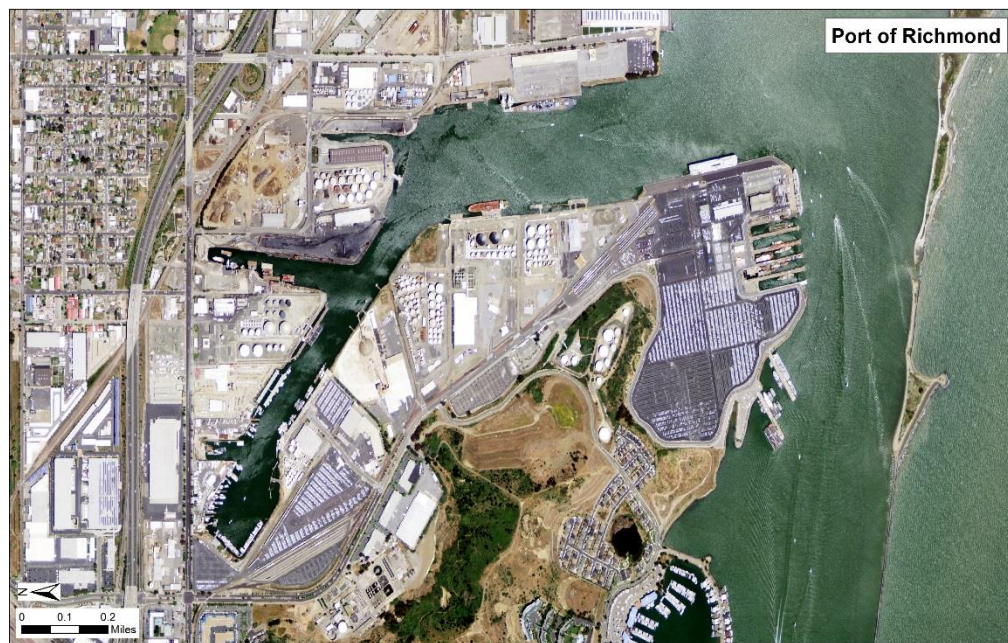

Figure A-6. Port of Richmond.

Table A-11. Richmond key characteristics

Characteristic	Strength	Potential Limitation
Harbor Location	Protected Harbor	Not directly on ocean
Navigation	38 ft. Navigable Depth. Accommodates 500 ft. LOA vessels. 500 ft. wide Navigation Channel.	-
Air Draft	-	Air draft limited by Golden Gate Bridge
Upland Area	Potentially available land available for redevelopment (130 acres)	Much of available upland appears to be used for roll-on roll-off automobile cargo
Crane	-	55 ton breakbulk crane capacity.
Shipyards	Existing graving docks	Graving docks are presently flooded
Road & Rail Access	Interstate Highway and Class 1 Rail	-
Quayside Facilities	Existing breakbulk cargo handling	-
Helipad	Helipad in vicinity	-
Workforce & Fabrication	Large workforce population to pull from	-
Other	-	-

Assessment

The port was classified as a potential QRP for OFW and MHK, and fabrication and construction port for OFW and MHK, and an assembly port for MHK. Because the port is located inland of the Golden Gate Bridge, OFW assembly is not feasible at this location. Crane capacity at the port is limited because cargo at the Port of Richmond is primarily Liquid Bulk and Automobile, which do not require the use of large cargo cranes. To support OFW or MHK new crane or cranes would need to be procured. An investigation of bearing capacity would need to be conducted for the concrete wharves to ensure the area is suitable for handling heavy cargo. The graving docks which are on site (5 graving docks) would likely not be large enough to support OFW foundation construction, but could potentially be modified to an adequate width or depth for specific devices. Existing graving dock geometry is likely suitable for MHK assembly, but would likely require major rehab of the flooded docks. The site has good overland connectivity with Class 1 rail and interstate access. The port currently accommodates vessels over 500 ft. in length, and would be able to handle cargo vessels and barges required to transport OFW and MHK components.

Table A-12. Richmond port assessment and cursory gap analysis

Port Classification	Technology	Score	Potential Gap
Quick Reaction	OFW & MHK	4	No major gaps. Vessel specific moorage may be required.
Fabrication & Construction	OFW Turbine	2	Exclusive upland area development (10+ acres depending on throughput), and bearing capacity investigation. Graving dock rehabilitation may be conducted. New crane/SPMT.
	OFW Foundation	2	Exclusive upland area development (50+ acres depending on throughput), and bearing capacity investigation. Graving dock rehabilitation may be conducted. New crane/SPMT.
	MHK	2	Berth bearing capacity investigation. New crane/SPMT. Graving dock rehabilitation may be conducted.
Assembly	OFW Semi-Sub	-	N/A
	OFW TLP	-	N/A
	OFW Spar	-	N/A

Port Classification	Technology	Score	Potential Gap
MHK		2	10 acre facility with water access and new crane. May be conducted in rehabilitated graving dock.

- = Was not assessed based on results of Pre-screening analysis.

0 = Does not meet criteria and is not suitable due to not meeting primary criteria.

1 = May not meet all primary criteria for long-term use, but may be used for demonstration –scale projects.

2 = Meets primary criteria. Land redevelopment or purpose-built marine terminal or berth required.

3 = Meets primary criteria, and some secondary criteria. Moderate level of improvements needed.

4 = Meets all primary criteria and most if not all secondary criteria. Minimal improvements needed.

A1.7 San Francisco

Existing Facilities

The Port of San Francisco, located in the City and County of San Francisco, lies on the western edge of the San Francisco Bay. The port has 145 acres of paved cargo staging area (Port of San Francisco 2016). It has six deepwater berths, covers 7.5 miles of waterfront, and has four gantry cranes. The port specializes in non-containerized cargo, which includes experience handling wind turbine component. The port is unable to develop container trade due to poor rail access, inability to move double-stack container trains due to tunnel height restrictions, and limited room for expansion. Major State Highway System routes serving the Port include US 101, I-80, I-580, I-680, I-880, SR-84, SR-92 (CalTrans 2016)

The Port is also known for having a large floating dry dock dedicated to ship repair (CalTrans 2016). The dry docks are operated by BAE systems, and have approximate dimensions of 530 ft. by 90 ft., and 900 ft. by 150 ft. Crane capacity at the dry dock is approximately 15 tons, and 60 tons, respectively. In addition to the floating dry docks, four full-service layberths, and small boat shops are located nearby.

The Pier 80 breakbulk terminal is 69 acres, with 1000 psf bearing capacity, 2,700 ft. lineal length, multiple 40 ton cranes, and a depth of 40 ft. MLLW. The Pier 94/96 breakbulk terminal has 3 berths, 2,450 feet of lineal length, 800 psf bearing load capacity, on dock rail access, a 40 ton crane, 15 acres of paved land, and a berth depth of 40 ft. MLLW. Behind Piers 90-94 there are approximately 23 acres of unimproved land which the port is planning to re-develop for new uses (Port of San Francisco 2016).

Table A-13. San Francisco key characteristics

Characteristic	Strength	Potential Limitation
Harbor Location	Sheltered harbor	No direct access to Ocean
Navigation	38 ft. depth, 600 ft. width navigation channel.	-
Air Draft	-	Restricted by regional bridges
Upland Area	-	Limited available land available for redevelopment (~25 acres)
Crane	-	60 ton crane
Shipyard	900 ft. by 150ft dry dock	-
Road & Rail Access	-	No class 1 Rail
Quayside Facilities	Multiple deep draft berths 800-1000 psf load bearing capacity	-
Helipad	-	-
Workforce & Fabrication	Large workforce population to pull from	-

Characteristic	Strength	Potential Limitation
Other	Existing breakbulk cargo handling. Experience with wind turbine components.	-

Assessment

The port was classified as a potential QRP for OFW and MHK, and fabrication and construction port for OFW and MHK, and an assembly port for MHK. Because of the ship repair facilities at BAE systems shipyard, and the large metropolitan area skilled labor is readily available. The cranes on the dry dock are likely sufficient to aid in construction of MHK or OFW devices. The size of the dry docks would likely be able to accommodate construction and assembly of an MHK device, but staging area may be limited for assembled devices, and long-term availability may be difficult to obtain. The width (~150 ft.) of the dry dock may not be wide enough for construction of Semi-sub or TLP foundations, which could be ~175 ft. or greater. Construction and staging of OFW foundations on the uplands appears difficult due to the limited amount of potentially available quayside. Construction of the OFW foundations or fabrication of OFW components would also likely require procurement of a new heavy lift crane to transfer to a transport vessel. Upland area availability, navigation channel geometry, and proximity to BOEM waters should allow for a QRP facility to be constructed. Because the port is located inland of the Golden Gate Bridge and Bay Bridge, OFW assembly is not feasible at this location.



Figure A-7. Port of San Francisco.

Table A-14. San Francisco assessment and cursory gap analysis

Port Classification	Technology	Score	Potential Gap
Quick Reaction	OFW & MHK	4	No major gaps. Vessel specific moorage may be required.
	OFW Turbine	2	Exclusive-use area (10+ acres) with direct quayside access. Crane/SPMT.
Fabrication & Construction	OFW Foundation	1	New Crane, exclusive upland area development (50+ acres depending on throughput). Dry dock width expansion may be required.
	MHK	3	Fabrication and quayside facility (1-5 acres).

Port Classification	Technology	Score	Potential Gap
Assembly	OFW Semi-Sub	-	N/A
	OFW TLP	-	N/A
	OFW Spar	-	N/A
	MHK	2	Quayside facility (~10 acres acres), exclusive quayside access. Crane/SPMT.

- = Was not assessed based on results of Pre-screening analysis.

0 = Does not meet criteria and is not suitable due to not meeting primary criteria.

1 = May not meet all primary criteria for long-term use, but may be used for demonstration –scale projects.

2 = Meets primary criteria. Land redevelopment or purpose-built marine terminal or berth required.

3 = Meets primary criteria, and some secondary criteria. Moderate level of improvements needed.

4 = Meets all primary criteria and most if not all secondary criteria. Minimal improvements needed.

A1.8 Benicia

Existing Facilities

The private Port of Benicia is located in Solano County on the northern bank of the Carquinez Strait approximately 19 miles northeast of the Port of Oakland and 25 miles northeast of the Port of San Francisco. Cargo at the port is primarily automobiles, but it also handles break-bulk and other heavy lift cargo. The Port is accessed by a single 2,400 ft. long pier deep-water pier with three berths on a 38 ft. depth navigation channel. The port is located one mile from Interstate access. Union Pacific railroad operations provide on-terminal rail service. Marine operations cover 645 acres, and appears to be primarily auto staging. The Benicia Industrial Park is an additional 4,000 acres (CalTrans 2016). A number of private facilities are located across the Strait, including the C&H Sugar docks at Crockett, while other installations are located to the east at Pittsburgh and Antioch, one of the largest being the USS-POSCO complex at Pittsburgh which handles steel coils. (Pacmar 2015)

Table A-15. Benicia key characteristics

Characteristic	Strength	Potential Limitation
Harbor Location	Protected	Not directly on Pacific Ocean
Navigation	Deep wide natural channel. Accommodates 500 ft. LOA vessels.	-
Air Draft	-	140 ft. limited by bridges.
Upland Area	Appx. 650 acres with marine access.	Primarily auto staging.
Crane	-	Limited crane infrastructure.
Shipyard	-	-
Road & Rail Access	Interstate Highway, Class 1 Rail	-
Quayside Facilities	2,400 ft. long pier	Appx. 80 ft. wide pier
Helipad	-	-
Workforce & Fabrication	Large metropolitan population	-
Other	Large paved area exists	-



Figure A-8. Benicia

Assessment

The port appears to be developed ideally for small cargo and autos, and large cargo may be difficult to maneuver from uplands to the pier, limiting manufacturing and capability for OFW and MHK, though less so for MHK. The pier is less than 100 feet wide is not likely to be wide enough to handle the larger OFW components. To accommodate OFW fabrication and construction, a new wharf/pier would need to be constructed, and a change in terminal uses would be required. Due to its location and berth arrangement, it is not well suited for QRP. Assembly of OFW is not feasible due to air draft restrictions from the Golden Gate Bridge. The industrial park may be able to provide manufacturing services for MHK devices, but an appropriate crane may be required if shipping components via vessel.

Table A-16. Benicia port assessment and cursory gap analysis

Port Classification	Technology	Score	Potential Gap
Quick Reaction	OFW & MHK	0	Distance from BOEM waters
Fabrication & Construction	OFW Turbine	2	New pier/wharf, access route, and redevelopment of upland areas from auto staging.
	OFW Foundation	2	New pier/wharf, access route, and redevelopment of upland areas from auto staging.
	MHK	3	High capacity cranes or SMPTs likely required.
Assembly	OFW Semi-Sub	-	Spar draft does not allow for assembly with existing technology within the port.
	OFW TLP	-	Spar draft does not allow for assembly with existing technology within the port.
	OFW Spar	-	Spar draft does not allow for assembly with existing technology within the port.

Port Classification	Technology	Score	Potential Gap
MHK		0	10 acre facility. New crane. Enough maneuvering area on pier.

- = Was not assessed based on results of Pre-screening analysis.

0 = Does not meet criteria and is not suitable due to not meeting primary criteria.

1 = May not meet all primary criteria for long-term use, but may be used for demonstration –scale projects.

2 = Meets primary criteria. Land redevelopment or purpose-built marine terminal or berth required.

3 = Meets primary criteria, and some secondary criteria. Moderate level of improvements needed.

4 = Meets all primary criteria and most if not all secondary criteria. Minimal improvements needed.

A1.9 Port of Morro Bay

Existing Facilities

The Port of Morro Bay is a small harbor located on the California coast, approximately 200 miles Northwest of Los Angeles. The harbor is home to a commercial fishing fleet and full-service marina with launch ramp. The port also provides a harbor patrol and Coast Guard station. There appears to be limited upland area available for staging operations. There is no crane or helipad infrastructure at the port.

Table A-17. Morro Bay key characteristics

Characteristic	Strength	Potential Limitation
Harbor Location	Protected. Directly on Pacific Ocean	-
Navigation	Channel Depth = 18 ft. Channel Width = 250 ft.	-
Air Draft	No air draft	-
Upland Area	-	-
Crane	-	Limited crane infrastructure
Shipyard	-	-
Road & Rail Access	-	-
Quayside Facilities	-	-
Helipad	-	-
Workforce & Fabrication	-	-
Other	Coast Guard Station	Remote area



Figure A-9. Morro Bay

Assessment

The port was classified as a potential QRP for OFW and MHK. Due to its proximity to BOEM waters (3 miles), POMB is physically well positioned as a QRP. Existing available quayside staging area appears to be limited (<1 acre) with most of the harbor surrounded by parking and public recreational boating and commercial fishing facilities. A purpose built crane may be required for cargo transfer. Purpose built berths for CTVs may be required.

Table A-18 Morro Bay port assessment and cursory gap analysis

Port Classification	Technology	Score	Potential Gap
Quick Reaction	OFW & MHK	2	New quayside exclusive-use berth likely required.
	OFW Turbine	-	Not assessed
Fabrication & Construction	OFW Foundation	-	Not assessed
	MHK	-	Not assessed
	OFW Semi-Sub	-	Not assessed
Assembly	OFW TLP	-	Not assessed
	OFW Spar	-	Not assessed
	MHK	-	Not assessed

- = Was not assessed based on results of Pre-screening analysis.

0 = Does not meet criteria and is not suitable due to not meeting primary criteria.

1 = May not meet all primary criteria for long-term use, but may be used for demonstration –scale projects.

2 = Meets primary criteria. Land redevelopment or purpose-built marine terminal or berth required.

3 = Meets primary criteria, and some secondary criteria. Moderate level of improvements needed.

4 = Meets all primary criteria and most if not all secondary criteria. Minimal improvements needed.

A1.10 Humboldt Bay

Existing Facilities

The Port of Humboldt Bay, located in Humboldt County, is California’s northernmost deep-water shipping port and the only port between San Francisco (258 miles south) and Coos Bay, Oregon (180 miles north). Forest products continue to dominate this Port, but a recent drop in trade (by more than 50 percent) has had a substantial impact on the Port. The Port can accommodate Panama Canal-class (Panamax) vessels. The Harbor entrance is 48 ft. deep and the Shipping Channel is 38 ft. deep. The port contains 9 deep draft berths. 15 percent of Humboldt Bay’s 33 miles is considered appropriate for harbor facility development. (humboldtby.org). According to CalTrans, truck length is limited due to highways (US 1010 and SR 299), and cargo handling facilities are in disrepair. The Redwood 1 terminal has 35 ft. depth, 1100 ft. length berth, wood dock, 60 acres of storage, 2 warehouses, and a 2 ton crane. It is currently being used for various purposes. The Redwood 2 terminal has a 38’ depth, 1200 ft. length berth, warehouses, 89 acres of storage, and 20 acres of tarmac. This terminal is presently in hazard cleanup process. The long-term goal for the terminal is to repurpose the area into a National Marine Research and Innovation Park. Schneider Dock is located at the old Pacific Affiliates Dock and according to port specifications has unlimited Load, 400 ft. berth length, 35 ft. depth, 11 acres upland storage. Fields Landing boatyard can accommodate boats up to 100 ft. in length for open air storage, and has a 150 ton capacity lifting hoist. An indoor facility is available for boat repair for vessels up to 80 ft. in length.

Table A-19. Humboldt Bay strengths and potential limitations to support OFW and MHK

Characteristic	Strength	Potential Limitation
Harbor Location	Sheltered harbor	-
Navigation	38 ft. Depth, 400 ft. width Navigation Channel. Accommodates 500 ft. LOA vessels.	-
Air Draft	No air draft restrictions	-
Upland Area	Quayside land available for redevelopment (~170 acres).	-
Crane	-	2 ton crane
Shipyard	-	150 ton capacity lifting hoist
Road & Rail Access	-	No rail access and no Interstate Highway Access
Quayside Facilities	Multiple deep draft berths	-
Helipad	-	No helipad in vicinity
Workforce & Fabrication	Minor boat repair facilities	No major manufacturing facilities. Small metropolitan area with remote location.
Other	Historically active port	

Assessment

The port was classified as a potential QRP for OFW and MHK, a potential fabrication and construction port for OFW and MHK, and an assembly port for OFW Semi-Sub and TLP, and MHK. The port’s biggest assets related to OFW and MHK development (land, no air draft restriction, and navigation channel geometry, proximity to the ocean), show that assembly and quick reaction facilities appear feasible with some significant facility upgrades. Anchor handling tugs, bulk carriers, and other offshore construction vessels would likely be able to be accommodated, but may require upgrades to upland facilities such as crane capability. Manufacturing and fabrication at the port is less likely due to the remote location and limited overland transport connections. OFW assembly could potentially be conducted quayside at one of the Redwood terminals, but would potentially require

purpose built facilities such as construction of a new concrete wharf, and potential berth dredging. Channel depth may limit tow-out operations to high tide. Schneider dock may require lengthening and other various upgrades prior to use. MHK construction and assembly at these sites is also possible, but would likely require wharf upgrades (bearing capacity, crane).



Figure A-10. Humboldt Bay shipping terminals map (left), and log transport vessel at the port (right)

Figure A-20. Humboldt Bay assessment and cursory gap analysis.

Port Classification	Technology	Score	Potential Gap
Quick Reaction	OFW & MHK	3	May require berth rehabilitation. Vessel specific moorage may be required. Helipad may be required
	OFW Turbine	2	Exclusive-use area (10+ acres) with direct quayside access. New berth. Crane/SPMT.
Fabrication & Construction	OFW Foundation	2	New Crane, exclusive upland area development (50+ acres depending on throughput). New berth. Crane/SMPT.
	MHK	2	Fabrication facility (1-5 acres). Likely a new berth. Crane/SPMT.
Assembly	OFW Semi-Sub	2	Berth dredging may be required. New crane. Rehabilitation and strengthening of existing docks or construction of new facility.
	OFW TLP	2	Berth dredging may be required. New crane. Rehabilitation and strengthening of existing docks or construction of new facility.
	OFW Spar	0	Spar draft does not allow for assembly with existing technology within the port.
	MHK	2	10 acre facility with berth. Likely a new crane. Berth may need rehabilitation and strengthening.

- = Was not assessed based on results of Pre-screening analysis.

0 = Does not meet criteria and is not suitable due to not meeting primary criteria.

- 1 = May not meet all primary criteria for long-term use, but may be used for demonstration –scale projects.
- 2 = Meets primary criteria. Land redevelopment or purpose-built marine terminal or berth required.
- 3 = Meets primary criteria, and some secondary criteria. Moderate level of improvements needed.
- 4 = Meets all primary criteria and most if not all secondary criteria. Minimal improvements needed.

A.2. Oregon

A2.1 Brookings

Existing Facilities

The Port of Brookings Harbor (POBH) is a shallow draft harbor located at the meeting point of the Chetco River and Pacific Ocean, approximately 5 miles north of the Oregon-California border. It owns approximately 60 acres of marine property. The harbor is home to a commercial fishing fleet and features a full-service marina, six-lane launch ramp and TravelLift services for haul out. POBH is listed as a “Harbor of Refuge” by the U.S. Coast Guard. According to the POBH strategic plan, commercial marina enlargement is a potential port project opportunity. The port owns a vacant piece of property used for parking and another warehouse type building which is vacant.

Table A-21. Brookings key characteristics

Characteristic	Strength	Potential Limitation
Harbor Location	Sheltered harbor with direct ocean access	-
Navigation	14 ft. draft available.	-
Air Draft	No air draft restriction	-
Upland Area	Additional port property may be developed	Limited existing available staging area.
Crane	-	No Crane
Shipyards	Minor ship repair facilities.	-
Road & Rail Access	-	State Road access only.
Quayside Facilities	130 ft. berth length	-
Helipad	-	No helipad located at the port
Workforce & Fabrication	-	Limited supply skilled workforce.
Other	-	-

Assessment

The port was classified as a potential QRP for OFW and MHK. Due to its proximity to BOEM waters (3 miles), the port is physically well positioned as a QRP. Existing available quayside staging area appears to be limited (<1 acre) with most of the harbor surrounded by parking, dry dock, or staging for the current commercial fishing fleet. Enlargement of the marine could provide for a QRP facility. A purpose built crane may be required for cargo transfer. Although not located at the harbor, there is a helipad at the Brookings State Airport, approximately 5 miles away.

Table A-22. Brookings port assessment and cursory gap analysis

Port Classification	Technology	Score	Potential Gap
Quick Reaction	OFW & MHK	2	Additional quayside area is required for maintenance and operational support.
Fabrication & Construction	OFW Turbine	-	Not assessed
	OFW Foundation	-	Not assessed
	MHK	-	Not assessed
Assembly	OFW Semi-Sub	-	Not assessed
	OFW TLP	-	Not assessed
	OFW Spar	-	Not assessed
	MHK	-	Not assessed

- = Was not assessed based on results of Pre-screening analysis.
- 0 = Does not meet criteria and is not suitable due to not meeting primary criteria.
- 1 = May not meet all primary criteria for long-term use, but may be used for demonstration –scale projects.
- 2 = Meets primary criteria. Land redevelopment or purpose-built marine terminal or berth required.
- 3 = Meets primary criteria, and some secondary criteria. Moderate level of improvements needed.
- 4 = Meets all primary criteria and most if not all secondary criteria. Minimal improvements needed.



Figure A-11. Port of Brookings harbor

A2.2 Coos Bay

Existing Facilities

The Port of Coos Bay is located 95 miles north of the Oregon-California border and 18 miles from BOEM waters, is the largest deep-draft port between San Francisco and Washington State. Maintained by the USACE, the channel (37 ft. deep) is 1,150 ft. wide at the entrance mark, reducing to 700 ft. by Channel Mile 0, and further reducing to 300 ft. at Channel Mile 1. There is a horizontal clearance of 197 ft. at the railroad bridge spanning from Jordan Point to North Point (Channel Mile 9.2) and a vertical clearance restriction of 149 ft. at the U.S. 101 Bridge

(Channel Mile 9.5). The Port owns more than 1,000 acres of land on the North Spit area of lower Coos Bay. Port jurisdiction currently includes seventeen terminals, five of which are located seaward of both bridges and their associated horizontal or vertical clearance restrictions. It appears that no crane infrastructure currently exists at the port. The port has access to U.S. Hwy 101 and Class 3 rail network. A rail spur runs down the west and west bank of the bay. Helipad infrastructure can be found nearby at the Southwest Oregon Regional Airport. Developed upland area appears to be available (~20 acres), primarily at the 5 port facilities seaward of the rail and Hwy. 101 bridges. The port currently services vessels on the order of 500 ft. in length. Shipyard facilities can be found nearby the port at Charleston Shipyard. The Jordan Cove project proposed on Coos River's North Spit in North Bend includes an application for a new access channel and marine slip. Southern Oregon Marine, Inc. operates a 40-hectare marine oriented construction and repair facility located 16 km upstream from the harbor entrance (Advanced Research, 2009). Port is considering the feasibility of developing a General Purpose Cargo Terminal. Such a terminal could be utilized by break bulk, project or similar cargos, and could also serve as a staging, assembly, and deployment area for offshore wind energy platforms.

Figure A-23 Coos Bay key characteristics

Characteristic	Strength	Potential Limitation
Harbor Location	Sheltered harbor and near BOEM waters (13 miles).	-
Navigation	Deep-water draft port. Currently serves +500 ft. vessels – limited vessel navigation restrictions anticipated	The existing navigable depth (37 ft.) is less than the conceptual-level estimate for required depth for assembled Semi-sub and TLP tow out, though with favorable tides, (diurnal tide range of approximately 7.6 ft.), tow-out may be possible.
Air Draft	150 ft. 5 terminals without horizontal and vertical clearance restriction	Horizontal and vertical clearance restrictions at 12 of 17 terminals
Upland Area	Approximately 1000 acres of potential development area owned by the port.	Limited developed staging area available.
Crane	-	-
Shipyard	Ship repair services available nearby. include haul out services are available for vessels up to 60 tons	-
Road & Rail Access	Access to Hwy. 101 and Class 3 rail network	-
Quayside Facilities	-	-
Helipad	-	No helipad located at the port
Workforce & Fabrication	Coos Bay is manufacturing hub for central/south Oregon coast. Southwestern Oregon Community College	-
Other	Potential development at Jordan Cove to support OFW.	-

Assessment

The port was classified as a potential QRP for OFW and MHK, a potential fabrication and construction port for OFW and MHK, a potential assembly port for Semi-Sub and TLP, and an assembly port for MHK. Port proximity to BOEM waters (14 miles) is within the 40 mile criteria for quick reaction ports. Available upland areas appear sufficient to meet quick reaction operation criteria (1-2 acres). Shipyard facilities appear to be appropriate for repair and maintenance of quick reaction vessels. Because the port currently services vessels 500 ft. in length, few navigation issues should arise as an fabrication and construction port seaward of the highway and rail bridges.

However, Semi-Sub and TLP OFW foundations channel width guidelines (~330 ft.) are not met by the limiting width of the channel (300 ft.), and so more detailed navigation analysis would be required to allow transport of specific devices. The horizontal clearance of 197 ft. at the rail bridge will likely preclude the fabrication and construction of OFW foundations to/from ports landward of the bridge due to the width restriction. The vertical clearance of 149 ft. at the Hwy. 101 Bridge will affect the fabrication and construction of OFW Foundations and MHK units. Fabrication, construction, and assembly facilities would be best suited seaward of the bridges. Though privately held land is potentially available, commercial-scale facilities would most likely require land redevelopment for component storage and transport, as well as a new heavy load wharf. The proposed Jordan Cove project which proposes creation of a new slip with access to the navigation channel could also potentially serve as access for OFW or MHK construction and assembly. Required development is similar in scope to Humboldt Bay. The existing navigable depth (37 ft.) is less than the conceptual-level estimate for required depth for assembled Semi-sub and TLP tow out, though with favorable tides, (diurnal tide range of approximately 7.6 ft.), tow-out may be possible. The Lower Coos Bay Channel Modification project is planned, and would increase available navigable depths which would improve navigation conditions for OFW foundations.

Table A-24. Coos Bay port assessment and cursory gap analysis

Port Classification	Technology	Score	Potential Gap
Quick Reaction	OFW & MHK	3	Small crane, helipad may be required. Vessel specific moorage may be required.
Fabrication & Construction	OFW Turbine	2	Exclusive-use area (10+ acres) with direct quayside access. New berth. Crane/SPMT.
	OFW Foundation	2	Exclusive-use area (50 acres) with direct quayside access. New berth. Crane/SPMT.
	MHK	2	Fabrication facility (1-5 acres). Likely a new berth. Crane/SPMT.
Assembly	OFW Semi-Sub	2	Berth dredging may be required. New crane. Rehabilitation and strengthening of existing docks or construction of new facility. Detailed navigation analysis.
	OFW TLP	2	Berth dredging may be required. New crane. Rehabilitation and strengthening of existing docks or construction of new facility. Detailed navigation analysis.
	OFW Spar	-	Spar draft does not allow for assembly with existing technology within the port.
	MHK	2	10 acre facility with berth. Likely a new crane. Berth may need rehabilitation and strengthening.

- = Was not assessed based on results of Pre-screening analysis.

0 = Does not meet criteria and is not suitable due to not meeting primary criteria.

1 = May not meet all primary criteria for long-term use, but may be used for demonstration –scale projects.

2 = Meets primary criteria. Land redevelopment or purpose-built marine terminal or berth required.

3 = Meets primary criteria, and some secondary criteria. Moderate level of improvements needed.

4 = Meets all primary criteria and most if not all secondary criteria. Minimal improvements needed.



Figure A-12. Port of Coos Bay

A2.3 Umpqua

Existing Facilities

The Port of Umpqua, located on the Umpqua River, is a small port with docking facilities mainly catering to commercial fishing vessels. The port has shipyard facilities nearby at Fred Wahl Marine Construction Inc. and Reedsport Machine & Fabrication LLC., located in Reedsport and Salmon Harbor Marina respectively. The commercial dock has a crane with a 2,200 lbs capacity. Upland staging area appears to be limited without redevelopment. Winchester Bay Marina is located approximately 2 miles inland from the Pacific.

Table A-25. Umpqua key characteristics

Characteristic	Strength	Potential Limitation
Harbor Location	Sheltered Harbor Close to BOEM waters (14 miles)	-
Navigation	Channel Depth = 22 ft. Channel Width = 200 ft.	-
Air Draft	No air draft.	-
Upland Area	-	Limited upland area (~1 acre)
Crane	-	1 ton crane
Shipyard	2 shipyard facilities nearby.	No dry dock
Road & Rail Access	State Road access	No Hwy/Interstate access. No rail access.
Quayside Facilities	-	-
Helipad	-	No helipad on-site.
Workforce & Fabrication	-	Remote area
Other	-	-

Assessment

The port was classified as a potential QRP for OFW and MHK. Because the port has facilities close the Pacific. Since the area meets the primary criteria a QRP facility could potentially be constructed at Winchester Bay or in Reedsport. CTV vessel maintenance appears to be available with two local shipyards in the near vicinity of the port. No helipad infrastructure is available at the port or at nearby airport facilities.

Table A-26. Umpqua port assessment and cursory gap analysis

Port Classification	Technology	Score	Potential Gap
Quick Reaction	OFW & MHK	2	Purpose built berth for CTV, Helipad, and upland development likely to be required
Fabrication & Construction	OFW Turbine	-	N/A
	OFW Foundation	-	N/A
	MHK	-	N/A
Assembly	OFW Semi-Sub	-	N/A
	OFW TLP	-	N/A
	OFW Spar	-	N/A
	MHK	-	N/A

- = Was not assessed based on results of Pre-screening analysis.

0 = Does not meet criteria and is not suitable due to not meeting primary criteria.

1 = May not meet all primary criteria for long-term use, but may be used for demonstration –scale projects.

2 = Meets primary criteria. Land redevelopment or purpose-built marine terminal or berth required.

3 = Meets primary criteria, and some secondary criteria. Moderate level of improvements needed.

4 = Meets all primary criteria and most if not all secondary criteria. Minimal improvements needed.

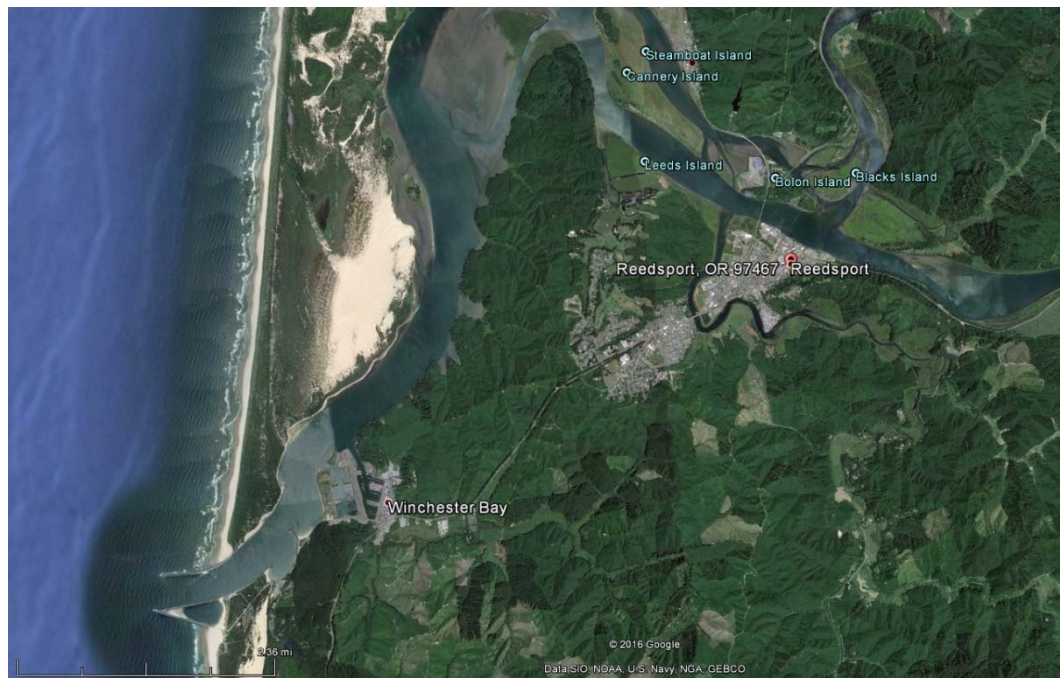

Figure A-13 Port of Umpqua Area

A2.4 Newport

Existing Facilities

The Port of Newport, located in Yaquina Bay 113 miles south of the Columbia River Mouth, is one of three deep draft ports on the Oregon Coast. The port's Newport International Terminal primarily deals with fabrication of forest products. Ten (10) acres of industrial land is currently vacant and features utilities in addition to 30 acres of bulk cargo storage adjacent to the terminal. The cargo docks at the terminal are 1.5 miles from the ocean entrance. A 30-ton mobile crane is available for use at the terminal. The port also features a small port with both commercial and recreational marina facilities. With moorage for approximately 200 commercial fishing vessels, the commercial marina also features a 300 ft. service berth with 4 hoists (1-5 ton) and a 200 ft. floating dock for dockside vessel repair. Shipwright services are available on-site and marine supplies can be found nearby. Although no helipad facility is found at the port, one is located at the Newport Municipal Airport, less than 5 miles from the port

Table A-27. Newport key characteristics

Characteristic	Strength	Potential Limitation
Harbor Location	Sheltered Harbor. Close to BOEM waters (5 miles).	-
Navigation	Channel Depth = 30 ft., Channel Width = 300 ft., Deep-draft berth	-
Air Draft	-	135 ft.
Upland Area	Upland staging area and possible development available (~40 acres).	-
Crane	30 ton mobile crane	-
Dry Dock	Shipwright on-site.	No dry-dock
Road & Rail Access	Access to Hwy. 101.	No rail access.
Quayside Facilities	-	-
Helipad	-	No Helipad on-site.
Workforce & Fabrication	-	Remote area
Other	-	-

Assessment

The port was classified as a potential QRP for OFW and MHK, as well as a potential fabrication and construction port and assembly port for MHK. The close proximity of the port to potential BOEM waters, lack of navigation issues and available upland staging area makes its location attractive as a quick reaction port and a potential fabrication and construction port and assembly port for MHK. Considerations for air draft requirements for MHK import-export port (IEP) and AP should be carefully assessed due to the 135 ft. air draft of the Hwy. 101 bridge seaward of the port. Barges may be required for component transport rather than bulk carriers. Additional crane capacity may be required for MHK construction and assembly operations (depending on technology type), but the 30 ton crane on site is sufficient for quick response crew transfer vessels.



Figure A-14 Port of Newport

Table A-28. Newport port assessment and cursory gap analysis

Port Classification	Technology	Score	Potential Gap
Quick Reaction	OFW & MHK	4	No major gaps. Helipad may be required. Vessel specific moorage may be required.
	OFW Turbine	-	N/A
Fabrication & Construction	OFW Foundation	-	N/A
	MHK	3	Crane upgrades may be required.
Assembly	OFW Semi-Sub	-	N/A
	OFW TLP	-	N/A
	OFW Spar	-	N/A
	MHK	3	Crane upgrades required.

- = Was not assessed based on results of Pre-screening analysis.

0 = Does not meet criteria and is not suitable due to not meeting primary criteria.

1 = May not meet all primary criteria for long-term use, but may be used for demonstration –scale projects.

2 = Meets primary criteria. Land redevelopment or purpose-built marine terminal or berth required.

3 = Meets primary criteria, and some secondary criteria. Moderate level of improvements needed.

4 = Meets all primary criteria and most if not all secondary criteria. Minimal improvements needed.

A2.5 Toledo

Existing Facilities

The port of Toledo, located on the Yaquina River, upstream of Newport, is a small port mainly catering to recreational use and commercial fishing vessels. Although currently limited, waterfront property is available for development from the port. The port is located 16 miles from BOEM waters. Vessel repairs are located just south of the port at the Port of Toledo Boatyard which, appears to have haul-out facilities, ship repair services, and limited on-land vessel storage. A 54 ft. vertical clearance restriction exists at the entrance to the marina facilities where moorage is available.



Figure A-15 Port of Toledo

Table A-29. Toledo key characteristics

Characteristic	Strength	Potential Limitation
Harbor Location	Sheltered Harbor. Close to BOEM waters (16 miles).	-
Navigation	Channel Depth = 10 ft. Channel Width = 150 ft.	-
Air Draft	-	135 ft.
Upland Area	-	Limited upland area.
Crane	-	No Crane.
Dry Dock	Ship repair services. Vessel haul-out.	No Dry-dock.
Road & Rail Access	State Road access	No Hwy/Interstate access. No rail access.
Quayside Facilities	-	-
Helipad	-	No Helipad on-site.
Workforce & Fabrication	-	Remote area
Other	-	-

Assessment

The port was classified as a potential QRP for OFW and MHK, as well as a potential fabrication and construction port for MHK. Available developed upland areas are limited and would likely require redevelopment for quick reaction (OFW and MHK) and fabrication and construction port for MHK. Purpose built berths for CTVs may be required if used as a home port. Ship repair services are likely available to service CTV vessels for vessels in Newport or Toledo. Both QRP and IEP operations at the port would require purpose built crane facilities. Development at or adjacent to the existing marina would be restricted by the 54 ft. vertical clearance identified by the port.

Table A-30. Toledo port assessment and cursory gap analysis

Port Classification	Technology	Score	Potential Gap
Quick Reaction	OFW & MHK	2	Developed upland area. Small cargo crane.
	OFW Turbine	-	
Fabrication & Construction	OFW Foundation	-	N/A
	MHK	0	Upland staging area requirements. Crane upgrades required.
	OFW Semi-Sub	-	
Assembly	OFW TLP	-	N/A
	OFW Spar	-	N/A
	MHK	-	N/A

- = Was not assessed based on results of Pre-screening analysis.

0 = Does not meet criteria and is not suitable due to not meeting primary criteria.

1 = May not meet all primary criteria for long-term use, but may be used for demonstration –scale projects.

2 = Meets primary criteria. Land redevelopment or purpose-built marine terminal or berth required.

3 = Meets primary criteria, and some secondary criteria. Moderate level of improvements needed.

4 = Meets all primary criteria and most if not all secondary criteria. Minimal improvements needed.

A2.6 Garibaldi

Existing Facilities

Port of Garibaldi, located on Tillamook Bay directly adjacent to the Pacific Ocean, is a small shallow draft port that serves the charter, lumber, and commercial fishing industries. The port has moorage for 277 vessels. There is currently no crane at the port. A helipad is available at the port with a 100 ft. wide octagonal safety zone. The Corps maintains an 18 ft. deep channel over the ocean bar at the entrance to Tillamook Bay; an 18 ft. deep, 200 ft. wide, three-mile-long channel to Miami Cove; a turning basin at Miami Cove; and a 12 ft. deep access channel to the Garibaldi small-boat basin. Existing area around the port may be limited at this time, but the port may have the option to purchase additional land around the marine to increase upland area available.

Table A-31. Garibaldi key characteristics

Characteristic	Strength	Potential Limitation
Harbor Location	Sheltered Harbor. Close to BOEM waters (6 miles).	-
Navigation	Channel Depth = 10 ft., Channel Width = 100 ft.	-
Air Draft	No air draft restriction	-
Upland Area	Additional upland area may purchase by the port.	Limited existing upland area.
Crane	-	No crane.
Shipyard	Big Tuna Marine and at Greg's Marine Service in the marina	-
Road & Rail Access	Hwy. access	No rail access. No Interstate access.
Quayside Facilities	-	-
Helipad	Helipad on-site	-
Workforce & Fabrication	-	Limited supply in skilled workforce.
Other	-	-



Figure A-16. Port of Garibaldi

Assessment

The port was classified as a potential QRP for OFW and MHK. Due to its proximity to BOEM waters (6 miles), POG is physically well positioned as a QRP. Available quayside staging area appears to be limited with most of the harbor surrounded by parking or staging for the current commercial fishing and lumber industries. With the purchase of additional land for storage and offices, the port would be a good option for a QRP. Because crane availability appears limited, a small cargo crane to support quick response operations is likely required. Garibaldi meets the navigation requirements for QRP, has an existing marina is suitably close to BOEM waters, and has suitable overland connections for QRP ports, but may be lacking in available quayside staging and storage area without redevelopment.

Table A-32. Garibaldi port assessment and cursory gap analysis

Port Classification	Technology	Score	Potential Gap
Quick Reaction	OFW & MHK	2	Limited upland staging area. Crane upgrades likely required.
	OFW Turbine	-	N/A
	OFW Foundation	-	N/A
Fabrication & Construction	MHK	-	N/A
	OFW Semi-Sub	-	N/A
	OFW TLP	-	N/A
Assembly	OFW Spar	-	N/A
	MHK	-	N/A

- = Was not assessed based on results of Pre-screening analysis.

0 = Does not meet criteria and is not suitable due to not meeting primary criteria.

1 = May not meet all primary criteria for long-term use, but may be used for demonstration –scale projects.

2 = Meets primary criteria. Land redevelopment or purpose-built marine terminal or berth required.

3 = Meets primary criteria, and some secondary criteria. Moderate level of improvements needed.

4 = Meets all primary criteria and most if not all secondary criteria. Minimal improvements needed.

A2.7 Astoria

Existing Facilities

Located just upstream from the meeting of the Columbia River and Pacific Ocean, but seaward of any air draft restrictions (such as the Astoria Bridge), the Port of Astoria is a deep water draft port with three piers, servicing the cruise ship, commercial fishing, and lumber industries. The 7.35 acre Pier 1 supports Astoria Forest products (Pier 1 West), as well as port-of-call berthing for cruise ships (Pier 1 North). Pier 2 (13.2 acres) serves the bulk fishing fleet with 3 faces: North, East and West (2,990 ft. total length). Pier 3 is used as a debarking and storage facility for Astoria Forest products as well as upland storage for boat haul out and vessel storage. However, Pier 3 is not currently a deep water berth. It is planned to upgrade Pier 3 into a deep draft terminal. The port has access to highway, state road and Class 3 rail facilities. Permanent on-dock crane equipment doesn't current exist at any of the piers.

Table A-33. Astoria key characteristics

Characteristic	Strength	Potential Limitation
Harbor Location	Sheltered Harbor. Close to BOEM waters (15 miles).	-
Navigation	Channel Depth = 43 ft. Channel Width = 600 ft.. Deep-draft port	-
Air Draft	No air draft restrictions	-
Upland Area	-	Pier 1 – 7 acres Pier 2 – 13 acres
Crane	-	No permanent crane.
Dry Dock	-	-
Road & Rail Access	Hwy. and state road access. Class 3 rail.	-
Quayside Facilities	-	-
Helipad	Helipad nearby – Astoria regional airport.	No helipad on-site
Workforce & Fabrication	-	Remote Area
Other	-	-

Assessment

The port was classified as a potential QRP for OFW and MHK, a potential fabrication and construction port for OFW, a fabrication and construction port for MHK, and an assembly port for OFW Semi-Sub, OFW TLP and MHK. Because of the large cruise ship vessels the port already accommodates, few to no navigation restrictions will likely be present for vessels associated with QR, IEP, and AP operations. Existing rail and road access would be able to provide adequate overland access to support fabrication, construction and assembly at the port. Although Pier 2 has 13.2 acres of area, its orientation and present use for the fishing industry may not leave enough room for commercial-scale fabrication and assembly support, or limit throughput capacity. A project crane would be required to support transport of fabricated components and assembly because no crane equipment is currently in place at the terminal. Demonstration-scale assembly is likely feasible, but would require temporary staging area and crane investigations. Considering other uses at the port, though Astoria is well positioned geographically to be an assembly Port, however, the total area at the port appears to limit the capability to provide full commercial scale assembly and staging infrastructure, based on study assumptions for commercial-scale development.



Figure 8-17. Port of Astoria

Table A-34. Astoria port assessment and cursory gap analysis

Port Classification	Technology	Score	Potential Gap
Quick Reaction	OFW & MHK	3	Small cargo crane and helipad. Vessel specific moorage may be required.
	OFW Turbine	-	N/A
Fabrication & Construction	OFW Foundation	-	N/A
	MHK	2	Re-use of exiting port land required with crane or SPMT. Berth bearing capacity would need to be evaluated relative to specific MHK technology.
Assembly	OFW Semi-Sub	1	Limited area to develop an exclusive-use terminal. Crane required.
	OFW TLP	1	Limited area to develop an exclusive-use terminal. Crane required.
	OFW Spar	0	Limited area to develop an exclusive-use terminal. Crane required.
	MHK	1	Limited area to develop an exclusive-use terminal. Crane required.

- = Was not assessed based on results of Pre-screening analysis.

0 = Does not meet criteria and is not suitable due to not meeting primary criteria.

1 = May not meet all primary criteria for long-term use, but may be used for demonstration –scale projects.

2 = Meets primary criteria. Land redevelopment or purpose-built marine terminal or berth required.

3 = Meets primary criteria, and some secondary criteria. Moderate level of improvements needed.

4 = Meets all primary criteria and most if not all secondary criteria. Minimal improvements needed.

A2.8 St. Helens

Existing Facilities

Approximately 25 miles north of Portland, Port of St. Helens is 98 miles upriver of the entrance to the Columbia River. There is 800 acres available for upland staging activities. Located at River Mile 53, the port's Westward Industrial Park features an existing deep draft berth with a 1200 ft. wharf. An additional 700 acres of land at Port Westward is on the process of being rezoned for use. The existing deep water wharf at Port Woodward does not appear to have a crane, and is primarily used for liquid bulk. The wharf was not built for heavy component transport. The Columbia City Industrial Park has 40 acres available and a draft between 24 ft. and 29 ft. The Highway 101 Bridge near the outlet of the Columbia River, which all OFW and MHK units would have to pass under, has a vertical clearance of 197 ft.



Figure A-18 St. Helens

Table A-35. St. Helens key characteristics

Characteristic	Strength	Potential Limitation
Harbor Location	Sheltered harbor.	Far from BOEM waters (98 miles).
Navigation	Channel Depth = 43 ft. Channel Width = 600 ft. Deep-draft berth available	-
Air Draft	-	197 ft.
Upland Area	1500 acres of potentially available upland area.	-
Crane	-	No crane.
Dry Dock	-	No dry-dock.
Road & Rail Access	Hwy 30 – 10 mins. Interstate 5 – 35 mins. On-site rail access for unit trains	-

Characteristic	Strength	Potential Limitation
Quayside Facilities	-	Likely in need of upgrade for OFW/MHK use.
Helipad	-	No helipad
Workforce & Fabrication	-	-
Other	-	-

Assessment

The port was classified as a potential fabrication and construction port for OFW and MHK, and an assembly port for MHK. Because of the existing upland area availability and existing and potential for marine terminals, St. Helens is likely we suited to provide for MHK and OFW fabrication with significant upland and marine terminal development. The existing deep draft wharf should be adequate to accommodate vessels on the order of at least 500 ft. in length, but to accommodate heavy components (and potentially a crane), the wharf will most likely require strengthening. Ports upstream of St Helens such as the Port of Portland regularly service large vessels (~500 – 1000 ft.) so few if any navigations restrictions are anticipated. The regional air draft restrictions preclude assembly at the port.

Table A-36. St. Helens port assessment and cursory gap analysis

Port Classification	Technology	Score	Potential Gap
Quick Reaction	OFW & MHK	-	N/A
Fabrication & Construction	OFW Turbine	2	Quayside area (10+ acres) to develop an exclusive-use terminal. Crane/SPMT likely required.
	OFW Foundation	2	Quayside area (50+ acres) to develop an exclusive-use terminal. Crane/SPMT likely required.
	MHK	2	Quayside area (1-5 acres) to develop an exclusive-use terminal. Crane/SPMT likely required.
Assembly	OFW Semi-Sub	-	N/A
	OFW TLP	-	N/A
	OFW Spar	-	N/A
	MHK	2	Quayside area (10+ acres) to develop an exclusive-use terminal. Crane/SPMT likely required.

- = Was not assessed based on results of Pre-screening analysis.

0 = Does not meet criteria and is not suitable due to not meeting primary criteria.

1 = May not meet all primary criteria for long-term use, but may be used for demonstration –scale projects.

2 = Meets primary criteria. Land redevelopment or purpose-built marine terminal or berth required.

3 = Meets primary criteria, and some secondary criteria. Moderate level of improvements needed.

4 = Meets all primary criteria and most if not all secondary criteria. Minimal improvements needed.

A2.9 Portland

Existing Facilities

The Port of Portland, located 100 miles upstream of the Pacific Ocean at the confluence of the Columbia and Willamette Rivers, handles over 17 million tons of marine cargo per year. The port owns several large industrial parks (Rivergate, Troutdale, Swan Island) totaling over 3,500 acres. Terminals 5, and 6 handle dry and liquid bulk materials, grain and mineral bulk, and multi-user container cargoes at the Rivergate Industrial District. Terminal 4 is multipurpose, 262-acre facility features seven ship berths capable of handling a variety of cargoes including

autos, forest products, steel, and dry and liquid bulks. Terminal 2 (53 acres, with open storage areas of 14.5 and 13.0 acres) is directly managed by the Port of Portland and features 2 cranes with 40 and 50 ton capacities. It has the deepest (29-37 ft.) berth, has multi-cargo capability with previous experience handling: forest products, steel, project cargo, bulk cargo, and roll-on/roll-off (Ro-Ro) cargo. It has direct ship-to-rail transfer with connections to Class 1 rail networks. The port also has significant dry-dock and ship building/repair capabilities at the Vigor dry-docks located at Swan Island Industrial Park. The largest dry dock at the Vigor shipyard has a width of 186 ft. and length of 960 ft. and a capacity of 90,000 tons. Along the Willamette and Columbia River, private or other governmental parcels with water access exist for potential purchase and redevelopment (Such as the 15 acre Terminal 1 property owned by the City of Portland, which includes a pier).

Table A-37. Portland key characteristics

Characteristic	Strength	Potential Limitation
Harbor Location	Sheltered harbor.	Far from BOEM waters (103 miles).
Navigation	Channel Depth = 43 ft. Channel Width = 600 ft. Deep-draft port	-
Air Draft	-	197 ft.
Upland Area	28 acres of developed land with open storage. Rivergate industrial district	-
Crane	600 ton gantry crane at Vigor Shipyard. 200 ton cranes at Gunderson Marine.	40 & 50 – ton capacity cranes
Dry Dock	Vigor Shipyard at port Dry-dock: 960 x 186 ft.	-
Road & Rail Access	Interstate access. Direct rail to ship transfer. Class 1 rail access.	-
Quayside Facilities	-	-
Helipad	-	No Helipad on-site.
Workforce & Fabrication	Major metropolitan area. Strong supply of skilled workforce.	-
Other	Gunderson Marine manufactures barges and has the West Coast's longest side-launch.	-

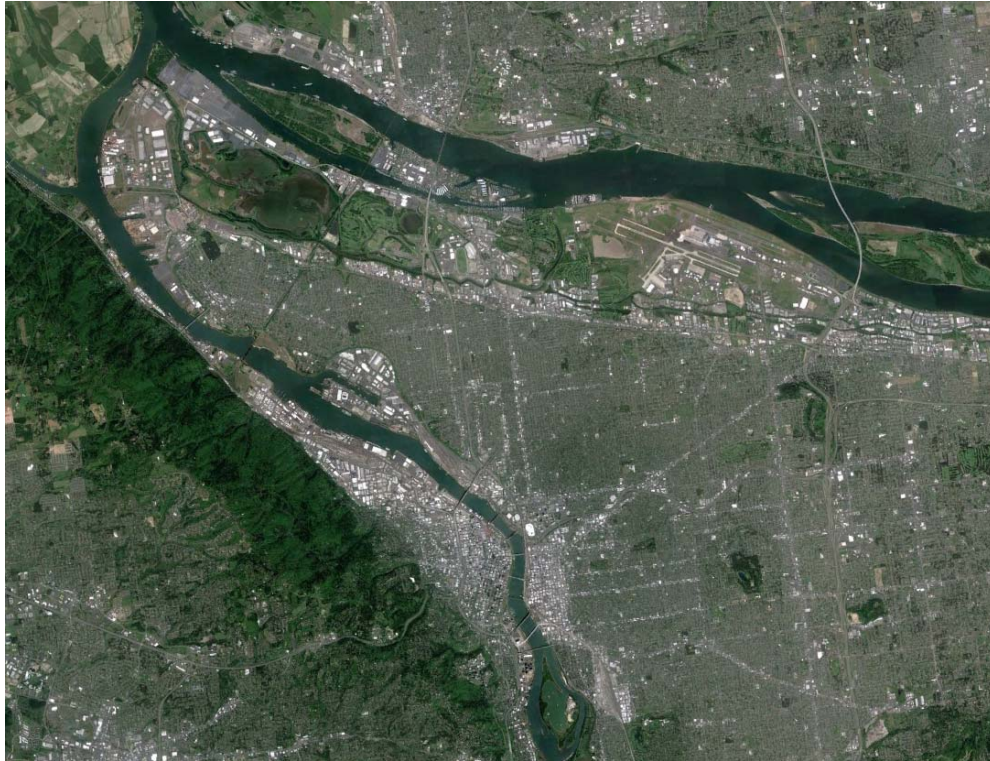

Figure A-19 Portland

Assessment

The port was classified as a potential fabrication and construction port for OFW and MHK, and an assembly port for MHK. Due to the size and amount of vessel traffic the port already accommodates, few (if any) navigation restrictions are likely to be encountered other than the regional 197 ft. vertical clearance restriction. The significant shipbuilding capability would likely be able to support construction of OFW and MHK construction, if there is availability at the facilities. However, the width of future OFW foundations still in development may also exceed the width available in the dry dock, and throughput would require a dedicated facility for an extended period of time. To maneuver OFW, and potentially MHK components at existing port facilities, cranes with greater lift capacity will likely be required than existing cranes (50 tons). SPMT technology is available for rent in the area, though for commercial-scale, SPMTs may be required to be purchased. Land use with direct quayside access on the existing terminals and industrial parks is near capacity, though additional land appears to be potentially available in the region. If land with marine access becomes available, the industrial parks areas are large enough to support development of an exclusive use facility and wharf. The Terminal 1 property in Portland may be suitable for a component fabrication facility, and has been used in the past as a construction and staging facility for port and fabrication related activities, though the property is scheduled for redevelopment for urban residential and commercial purposes.

Table A-38. Portland port assessment and cursory gap analysis

Port Classification	Technology	Score	Potential Gap
Quick Reaction	OFW & MHK	-	N/A
Fabrication & Construction	OFW Turbine	2	Quayside area (10+ acres) to develop an exclusive-use terminal. Crane/SPMT likely required.
	OFW Foundation	2	Quayside area (50+ acres) to develop an exclusive-use terminal. Crane/SPMT likely required.

Port Classification	Technology	Score	Potential Gap
Assembly	MHK	3	Crane/SPMT likely required.
	OFW Semi-Sub	-	N/A
	OFW TLP	-	N/A
	OFW Spar	-	N/A
	MHK	3	Crane/SPMT likely required.

- = Was not assessed based on results of Pre-screening analysis.

0 = Does not meet criteria and is not suitable due to not meeting primary criteria.

1 = May not meet all primary criteria for long-term use, but may be used for demonstration –scale projects.

2 = Meets primary criteria. Land redevelopment or purpose-built marine terminal or berth required.

3 = Meets primary criteria, and some secondary criteria. Moderate level of improvements needed.

4 = Meets all primary criteria and most if not all secondary criteria. Minimal improvements needed.

A.3. Washington

A3.1 Vancouver

Existing Facilities

The Port of Vancouver, located directly across the Columbia River from Portland and 100 miles upstream of the Pacific Ocean. The port features 5 terminals with 13 deep draft vessel berths. Class 1 rail access to the port is serviced by the BNSF, Union Pacific, CN, and CPR rail networks. The port is situated within 2 miles of I-5 and 10 miles of I-84 providing trucking routes to the north, east, and south. Air draft is restriction by the regional 197 ft. bridge heights. Port of Vancouver has previous experience handling wind energy components and large modularized components for the oil and gas industry. Terminals 2 (Berth 3) and Terminal 3 (Berth 8 & 9) are designated by the port as project cargo berths with 550 and 1250 ft. of berth length respectively. Terminal 2 has a dock capacity of 1000 psf. Terminal 3 has a dock capacity of 750 psf, an open storage area of 65 acres, and covered storage of 360,000 sq. ft. Terminal 5 features a dedicated heavy lift rail track specifically for heavy lift cargo and has 54 acres for on-port storage. The port has two 155 ton mobile cranes with a combined lift capacity (when used in tandem) of 230 tons.

The Port of Vancouver USA’s Columbia Gateway is the largest contiguous tract of undeveloped industrial property in Southwest Washington. The approximately 530-acre property, located just west of the port’s current operations, is zoned heavy industrial and has nearly a mile of direct waterfront on the Columbia River. A portion of the property will be available for industrial tenants with the potential uses of advanced manufacturing, assembly, warehousing and fabrication operations (Port of Vancouver 2015).

Table A-39. Vancouver, Washington key characteristics

Characteristic	Strength	Potential Limitation
Harbor Location	Sheltered harbor.	Far from BOEM waters (103 miles).
Navigation	Channel Depth = 43 ft., Channel Width = 500 ft. Deep-draft port	-
Air Draft	-	197 ft.
Upland Area	Terminal 3 – 65 acres, Terminal 5 – 54 acres. Up to 650 acres potentially available with development.	-
Crane	Two 155 ton mobile cranes, combined lift capacity of 230 tons.	-
Shipyard	Vigor shipyard nearby.	-

Characteristic	Strength	Potential Limitation
Road & Rail Access	Interstate access. Class 1 rail access	-
Quayside Facilities	Terminal 2 – 1000 psf. Terminal 5 heavy lift rail track	-
Helipad	Several heliports within 10 miles.	No helipad at port.
Workforce & Fabrication	Major metropolitan area. Strong supply of skilled workforce. Oregon Iron Works facility located near port.	-
Other	Experience manufacturing demonstration-scale MHK. Experience handling wind turbine components.	-



Figure A-20 Vancouver

Assessment

The port was classified as a potential fabrication and construction port for OFW and MHK, and an assembly port for MHK. Previous experience handling wind energy components and heavy lift project cargoes demonstrates the Port of Vancouver’s suitable infrastructure for fabrication and construction operations for OFW and MHK projects. Available upland storage space appears suitable for staging areas with supporting heavy cargo rail systems (Terminals 3 and 5). Although heavy lift mobile cranes are available at the port, the weight of 6-8 MW components may require higher capacity cranes (~400 tons). Terminal 3 has adequate bearing capacity (1000 psf) for most fabrication operations, with appropriate weight distribution measures. Terminal 2 may be sufficient (750 psf) for demonstration-scale efforts. The port already serves vessels 500 ft. or larger in length and few if any navigations restrictions are anticipated other than the 197 ft. clearance at the Highway 101 Bridge near the outlet of the Columbia River. Terminal 5 may be an appropriate location for fabrication facility leasing, and has been previously used for wind turbine component staging.

Table A-40. Vancouver port assessment and cursory gap analysis

Port Classification	Technology	Score	Potential Gap
Quick Reaction	OFW & MHK	-	N/A
	OFW Turbine	3	New Crane/SPMT likely required. Land development may be required. Quayside bearing capacity investigation.
Fabrication & Construction	OFW Foundation	2	Quayside area (50+ acres) to develop an exclusive-use terminal. Crane/SPMT likely required.
	MHK	3	New Crane/SPMT likely required. Land development may be required.

Port Classification	Technology	Score	Potential Gap
Assembly	OFW Semi-Sub	-	N/A
	OFW TLP	-	N/A
	OFW Spar	-	N/A
	MHK	3	Crane/SPMT likely required. Land development may be required.

- = Was not assessed based on results of Pre-screening analysis.

0 = Does not meet criteria and is not suitable due to not meeting primary criteria.

1 = May not meet all primary criteria for long-term use, but may be used for demonstration –scale projects.

2 = Meets primary criteria. Land redevelopment or purpose-built marine terminal or berth required.

3 = Meets primary criteria, and some secondary criteria. Moderate level of improvements needed.

4 = Meets all primary criteria and most if not all secondary criteria. Minimal improvements needed.

A3.2 Woodland

Existing Facilities

The Port of Woodland is situated between the Columbia River and Lewis River, approximately 20 miles down the Columbia River from the Port of Vancouver. The port sits adjacent to the I-5 corridor and has access to the BNSF Class 1 rail network. The port does not appear to have any currently developed on-river berths, with most port activities focused on industrial sites located within the City of Woodland. However, the port does have property available for development along the Columbia River; Austin Point (located in Cowlitz County), features 200 acres of zoned industrial use land with deep draft feasibility. Austin Point is located 7 miles from Interstate 5 and is 1.5 miles from the BNSF Class 1 rail line. No crane, berth, or upland staging facilities currently exists at the site.

Table A-41. Woodland key characteristics

Characteristic	Strength	Potential Limitation
Harbor Location	-	No on-water berths.
Navigation	Channel Depth = 43 ft. Channel Width = 600 ft.	-
Air Draft	-	197 ft.
Upland Area	200 acres of zoned industrial land available at Austin Point.	Significant development required.
Crane	-	No crane.
Dry Dock	-	No dry-dock
Road & Rail Access	Interstate Access.	Class 1 rail within 2 miles, but no direct access to Austin Point.
Quayside Facilities	-	No berth currently. Significant development required.
Helipad	-	-
Workforce & Fabrication	-	-
Other	-	-



Figure A-21 Woodland

Assessment

The port was classified as a potential fabrication and construction port for OFW and MHK. Current deep water draft berths required for OFW and MHK fabrication and construction ports do not currently exist at the port of woodland. However, there is significant available on-river land at Austin Point (already zoned) for a possible purpose built facility for OFW and MHK construction. This development would require the constructions of appropriate berthing facility with heavy lift crane capacity. With the amount of land available, Austin Point could potentially be used as a site for a cluster of manufacturing and fabrication related to OFW and MHK, but in addition to a purpose built facility, improvements to rail access may be required.

Table A-42. Woodland port assessment and cursory gap analysis

Port Classification	Technology	Score	Potential Gap
Quick Reaction	OFW & MHK	-	N/A
	OFW Turbine	2	Quayside area (10+ acres) to develop an exclusive-use terminal. Crane/SPMT likely required.
	OFW Foundation	2	Quayside area (50+ acres) to develop an exclusive-use terminal. Crane/SPMT likely required.
Fabrication & Construction	MHK	2	Quayside area (1-5+ acres) to develop an exclusive-use terminal. Crane/SPMT likely required.
	OFW Semi-Sub	-	N/A
Assembly	OFW TLP	-	N/A
	OFW Spar	-	N/A
	MHK	2	Quayside area (10 acres) to develop an exclusive-use terminal. Crane/SPMT likely required.

- = Was not assessed based on results of Pre-screening analysis.
- 0 = Does not meet criteria and is not suitable due to not meeting primary criteria.
- 1 = May not meet all primary criteria for long-term use, but may be used for demonstration –scale projects.
- 2 = Meets primary criteria. Land redevelopment or purpose-built marine terminal or berth required.
- 3 = Meets primary criteria, and some secondary criteria. Moderate level of improvements needed.
- 4 = Meets all primary criteria and most if not all secondary criteria. Minimal improvements needed.

A3.3 Kalama

Existing Facilities

The Port of Kalama, located on the Columbia River and directly adjacent to Interstate-5 (30 miles northwest of Portland), is a deep water port with 5 terminals. Four of five terminals are privately operated with the North Port Marine Terminal available for public use. The North Port Marine Terminal a total dock length of 900 ft. (including dolphins), a 43 ft. water depth, and a live load bearing capacity of 1000 psf. The port has a helipad on site and access to Class 1 rail network (BNSF and Union Pacific) adjacent to the port. There appears to be no breakbulk crane infrastructure currently at the port. The port has 13 acres of upland property available for development at their Kalama River Industrial park, situated south of the North Port Marine Terminal, though the Kalama River does physically separate the two sites. The North Port area is 200 acres in total, and the northern part of the area has been leased to Northwest Innovation Works, which is currently in the permitting phase for construction of a methanol production plant (Port of Kalama 2015).

The Central Port Industrial district is located just south of the Kalama Export facility and north of the marina channel, and is nearly fully occupied. The port may construct a lay berth facility as an interim use site. Redevelopment of facilities in this area will be evaluated as opportunities arise. A large portion of the Emerald Kalama Chemical property is undeveloped, consisting primarily of wetlands. The South Port area is also fairly well utilized by industry and marine terminals. The largest share of this property is leased to the TEMCO grain export elevator. This site also includes a vacant parcel the Port intends to develop for light industrial or other business use.

Table A-43. Kalama key characteristics

Characteristic	Strength	Potential Limitation
Harbor Location	Sheltered River Location.	70 miles from open ocean.
Navigation	Columbia River Navigation Channel is maintained at 43 ft. depth, 600 ft. width.	-
Air Draft	-	197 ft.
Upland Area	-	13 acres currently available for development beyond long-term leases.
Crane	-	Not located on site.
Dry Dock	-	N/A
Road & Rail Access	Interstate Highway and Class 1 Rail.	-
Quayside Facilities	Concrete wharf. Appx. 600ft. by 100ft. Bearing capacity 1000 psf.	-
Helipad	-	N/A
Workforce & Fabrication	Steel manufacturer on site.	-
Other	Additional lands may be available for development in the future.	-



Figure A-22 Kalama

Assessment

The port was classified as a potential fabrication and construction port for OFW and MHK. Port of Kalama appears to be a busy port with low vacancy rates. Purpose-built OFW and MHK fabrication and construction facilities may be limited by available upland area. Existing shipbuilding and iron works facilities may preclude fabrication of demonstration-scale MHK devices since these are likely to be built at existing facilities, but the port could likely accommodate purpose built MHK fabrication facilities and transport.

Table A-44 Kalama port assessment and cursory gap analysis

Port Classification	Technology	Score	Potential Gap
Quick Reaction	OFW & MHK	-	N/A
	OFW Turbine	0	Additional land required
Fabrication & Construction	OFW Foundation	0	Additional land required
	MHK	3	New Crane/SPMT likely required. Land development may be required. Quayside bearing capacity investigation.
Assembly	OFW Semi-Sub	-	N/A
	OFW TLP	-	N/A
	OFW Spar	-	N/A
	MHK	3	Crane/SPMT may be required (technology dependent)

- = Was not assessed based on results of Pre-screening analysis.

0 = Does not meet criteria and is not suitable due to not meeting primary criteria.

1 = May not meet all primary criteria for long-term use, but may be used for demonstration –scale projects.

2 = Meets primary criteria. Land redevelopment or purpose-built marine terminal or berth required.

3 = Meets primary criteria, and some secondary criteria. Moderate level of improvements needed.

4 = Meets all primary criteria and most if not all secondary criteria. Minimal improvements needed.

A3.4 Longview

Existing Facilities

The Port of Longview, located on the Columbia River 66 miles from the Pacific Ocean, features eight deep-draft marine terminals. The port has previous experience handling wind energy components and heavy lift cargo. Terminals at the port currently accommodate Panamax size vessels. Terminals 6, 7 and 8 handle breakbulk cargos, with 35 acres of uncovered storage at terminals 6 and 7 and 4.5 acres at Terminal 8. Terminal 6 and 7 have rail access, both of which have connections to both major Class 1 rail networks (BNSF and Union Pacific). A barge only terminal handles Ro-Ro breakbulk cargo. The port maintains a relationship with the International Longshore and Warehouse Union Local #21, which provides a strong workforce for cargo handling, equipment operation, and on-site setup and fabrication. Two parcels (35-45 acres) at the port may be available for lease in the future, with access to the marine terminals. In 2010 the Port purchased 280 acres of additional land four miles downriver at Barlow Point to supplement the 353 acres of industrial property at the port, which is nearing capacity. In its 2011 Master Planning report, several other large potential acquisition sites (totaling over 700 acres) were identified for port development within the Port District. According to the 2015 Comprehensive Scheme of Harbor Improvements (Port of Longview 2015) the Port plans for approximately 60,000 tons of wind energy related cargo per year.

Table A-45. Longview key characteristics

Characteristic	Pros	Cons
Harbor Location	Protected.	66 miles from open ocean.
Navigation	Columbia River Navigation Channel is maintained at 43 ft. depth, 600 ft. width.	-
Air Draft	-	197 ft.
Upland Area	35-40 acres of existing developed storage. Potentially up to 800 acres of land available.	-
Crane	-	114 ton mobile cranes.
Dry Dock	-	Not on site.
Road & Rail Access	Interstate Highway and Class 1 Rail.	-
Quayside Facilities	Accommodates Panamax vessels.	-
Helipad	-	N/A
Workforce & Fabrication	Windfarm component handling experience.	-
Other	Land available for redevelopment. Experience handling wind turbine components	-

Assessment

The Port of Longview is well positioned to provide facilities for development of purpose built-development of fabrication and construction facilities for OFW and MHK due to the potential of land area with river access that has the potential for redevelopment or acquisition in the Port District. Existing facilities at the port are near capacity, and may not be able to accommodate an additional 10+ acres of exclusive use area with direct quayside access required for OFW or MHK fabrication and construction. Air draft restrictions on the Columbia River preclude OFW assembly at the port with existing technology. Depending on the technology and scale, MHK fabrication and assembly may be able to be supported by existing facilities without major redevelopment (e.g. no new berths). The Columbia River Navigation Channel is able to accommodate vessels expected to be required to transport OFW and MHK components, and would also likely be able to accommodate Semi-Sub, TLP, and Spar transport prior to affixing the turbine.

Table A-46. Longview port assessment and cursory gap analysis

Port Classification	Technology	Score	Potential Gap
Quick Reaction	OFW & MHK	-	N/A
	OFW Turbine	2	Quayside area (10+ acres) to develop an exclusive-use terminal. Crane/SPMT likely required.
Fabrication & Construction	OFW Foundation	2	Quayside area (50+ acres) to develop an exclusive-use terminal. Crane/SPMT likely required.
	MHK	3	New Crane/SPMT likely required. Land development may be required. Quayside bearing capacity investigation.
	OFW Semi-Sub	-	N/A
Assembly	OFW TLP	-	N/A
	OFW Spar	-	N/A
	MHK	3	Crane may be required. Berth bearing capacity investigation may be required.

- = Was not assessed based on results of Pre-screening analysis.

0 = Does not meet criteria and is not suitable due to not meeting primary criteria.

1 = May not meet all primary criteria for long-term use, but may be used for demonstration –scale projects.

2 = Meets primary criteria. Land redevelopment or purpose-built marine terminal or berth required.

3 = Meets primary criteria, and some secondary criteria. Moderate level of improvements needed.

4 = Meets all primary criteria and most if not all secondary criteria. Minimal improvements needed.



Figure A-23. Longview

A3.5 Grays Harbor

Existing Facilities

The Port of Grays Harbor boundaries include all of Grays Harbor County, on Washington State's Pacific Coast. The Grays Harbor Federal Navigation Channel connects port facilities to the Pacific Ocean, and is dredged regularly. The port has a marine terminal rail system to terminals 1, 2 and 4. Terminal 4 is the Port's main general cargo terminal. It features over 100,000 sq. ft. of dried, covered warehouse space; a rail loop with on-dock rail access and 120 acres of paved cargo yard. Terminal 3 is a 150 acre site with a deep water, 600 ft. length all-concrete marine terminal, and is currently available. Terminal 3 has on site rail with access to both Class 1 railroads. Privately owned property adjacent to Terminal 3 is currently available for purchase. The IDD-1 Riverfront property in Hoquiam is owned by the port and has 45 acres of developable land along the Federal Navigation Channel. The Washington State Department of Transportation (WSDOT) built and owns a graving dock (appx 175 ft. x 800 ft. used to construct pontoons for a state highway project, and the facility may be available for sale after the project is completed (WSDOT, 2010). Additional private lands on the Chehalis River appear to be potentially available for redevelopment. The bascule bridge upriver of the port has a horizontal clearance of 150 ft. The Port also owns Westport Marina near the mouth of the harbor, and has berths up to 350 ft.

Table A-47. Grays Harbor key characteristics

Characteristic	Strength	Potential Limitation
Harbor Location	Protected. Westport Marina is located ~1 nmi from open ocean.	-
Navigation	36 ft. depth, 350 ft. min width. Tide range of 9.2 ft.	-
Air Draft	Port facilities unrestricted.	-
Upland Area	Approximately 200 acres for potential development	-
Crane	-	Limited crane infrastructure
Dry Dock	Graving dock	-
Road & Rail Access	Class 1 and 4-lane highway	-
Quayside Facilities	Concrete dock	Undeveloped quayside areas
Helipad	Port owns Boweman Airport. Also a helipad located at Westport Marina.	-
Workforce & Fabrication	Existing workforce for pontoon construction	-
Other	Graving dock at HWY 520 Pontoon Construction site.	-

Assessment

The Grays Harbor area appears to be able to support fabrication and assembly of OFW and MHK devices, with the development of purpose-built facilities. There are several locations in the harbor with water access and the necessary upland acreage requirements. Navigation channel geometry is sufficient for OFW and MHK fabrication and construction, though is near the conceptual-level depth limitations for assembled Semi-sub and TLP device tow out. Assembled devices may require tow out during favorable tides or other mitigation actions (to be determined). Major construction and fabrication projects (State Highway 520 Pontoons) have shown that a large skilled workforce is available. New quayside facilities may be required to be constructed (or upgraded) to meet the heavy-load demands of OFW components and cranes, depending on the exact location of a facility. Terminal 3 geometry may require modification to support maneuvering of OFW and MHK components. Further investigation of the WSDOT graving dock should be conducted to assess viability for re-use as an OFW or MHK assembly

facility. In some cases, additional upland infrastructure, such as paved storage areas, may be required. The port has strong rail connections to support OFW and MHK fabrication.



Figure A-24. Grays Harbor

Table A-48. Grays Harbor port assessment and cursory gap analysis

Port Classification	Technology	Score	Potential Gap
Quick Reaction	OFW & MHK	-	N/A
	OFW Turbine	3	Berth bearing capacity investigation. Crane/SPMT.
Fabrication & Construction	OFW Foundation	2	Purpose built facility required (berth, upland development).
	MHK	3	Berth bearing capacity investigation. Crane/SPMT.
Assembly	OFW Semi-Sub	2	Purpose built facility. Crane/SPMT.
	OFW TLP	2	Purpose built facility. Crane/SPMT.
	OFW Spar	0	Existing technology does not allow for assembly at Port.
	MHK	3	Crane or other assembly facility. Berth bearing capacity investigation may be required.

- = Was not assessed based on results of Pre-screening analysis.

0 = Does not meet criteria and is not suitable due to not meeting primary criteria.

1 = May not meet all primary criteria for long-term use, but may be used for demonstration –scale projects.

2 = Meets primary criteria. Land redevelopment or purpose-built marine terminal or berth required.

3 = Meets primary criteria, and some secondary criteria. Moderate level of improvements needed.

4 = Meets all primary criteria and most if not all secondary criteria. Minimal improvements needed.

A3.6 Port Angeles

Existing Facilities

The Port of Port Angeles is located on the Strait of Juan de Fuca, is the first full-service port en route to Puget Sound through the Strait of Georgia. The port has three deep draft terminals; T1, T3, and T7 which handle a variety of cargo such as forest products, container cargo, and heavy-lift cargo. Terminal 1 is used for general cargo loading/unloading but also has ship repair facilities with a skilled workforce on-site (PoPA). Terminal 3 is used for forest product transfers and has a 5 acre log yard. Terminal 3 is also the heavy lift pier. Terminal 7 accommodate cranes up to 200 tons, and primarily is used as a lay berth and has 4 acres of upland storage. Vigor Shipyards has a

facility with 2 piers and 5 cranes with up to 200 ton capability where they perform topside repairs. Rayonier Pier, a 75 acre former pulp mill facility, has been a Washington State Ecology Cleanup site since 2000 (Peninsula Daily News, 2011), and is located approximately 2 miles to the East of the port.

Table A-49. Port Angeles key characteristics

Characteristic	Strength	Potential Limitation
Harbor Location	Sheltered harbor	Far from BOEM waters (73 miles)
Navigation	35 ft. depth, no channel width restrictions (Strait of Juan de Fuca)	-
Air Draft	No air draft	-
Upland Area	Rayonier Site - 75 acres contaminated	3 – 5 acre log yard, T7 – 4 acres,
Crane	-	Crane available up to 200 tons
Shipyard	Topside repairs at Vigor	No dry dock
Road & Rail Access	Highway & State Road access	No rail access
Quayside Facilities	All berths 35ft. deep or greater.	-
Helipad	-	No helipad on-site
Workforce & Fabrication	Ship repair services available	-
Other	Large, deep protected harbor.	-

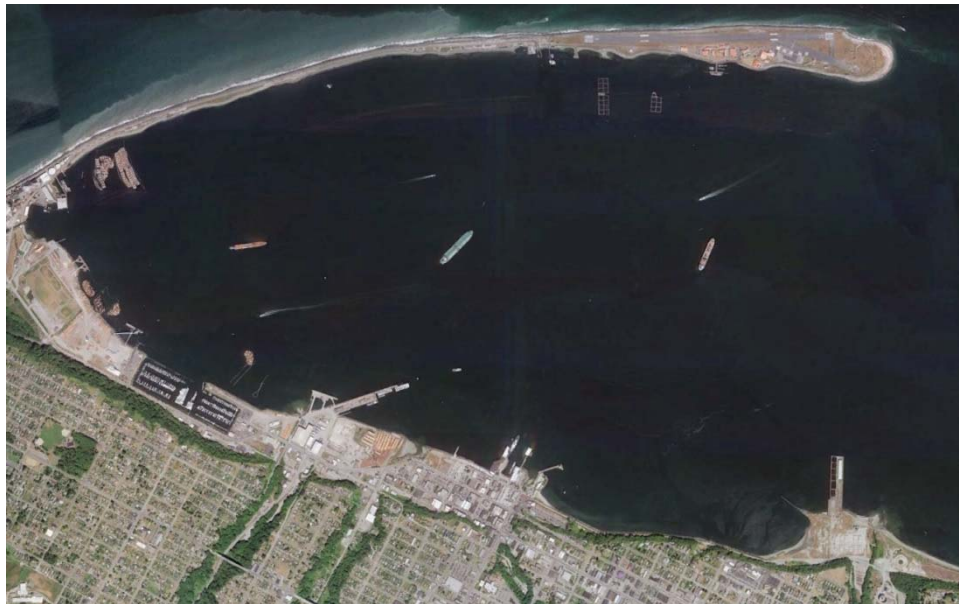

Figure A-25. Port Angeles

Assessment

The port was classified as a potential fabrication and construction port for OFW, a fabrication and construction port for MHK, an assembly port for OFW Semi-Sub, TLP and a potential assembly port for MHK. Current upland areas (~5 acres) are not sufficient for OFW construction (foundation and turbine) or OFW (Semi-Sub, TLP, and Spar) and MHK assembly operations. MHK demonstration-scale could likely be accommodated. Port Angeles appears to be able to accommodate MHK construction. The Rayonier site would provide acreage necessary for OFW and MHK fabrication or assembly, but would require significant cleanup and dredging. Outside of this there does not appear to be room for expansion of port facilities in the surrounding areas for a purpose built facility. Cranes are

available at the port, but lift capacities relative to MHK device lift needs would have to be confirmed for use in MHK construction. OFW assembly could potentially occur in the bay with an appropriate crane barge and development of a staging facility on-land.

Table A-50. Port Angeles port assessment and cursory gap analysis

Port Classification	Technology	Score	Potential Gap
Quick Reaction	OFW & MHK		
	OFW Turbine	2	Rayonier site cleanup, development, and rebuilt pier.
	OFW Foundation	2	Rayonier site cleanup, development, and rebuilt pier.
Fabrication & Construction	MHK	3	Depending on throughput requirements and location of fabrication facility (i.e. on-site, off-site). Crane/SPMT may be required
	OFW Semi-Sub	2	Rayonier site cleanup, development, and rebuilt pier.
Assembly	OFW TLP	2	Rayonier site cleanup, development, and rebuilt pier.
	OFW Spar	-	N/A
	MHK	2	Rayonier site cleanup, development, and rebuilt pier.

- = Was not assessed based on results of Pre-screening analysis.

0 = Does not meet criteria and is not suitable due to not meeting primary criteria.

1 = May not meet all primary criteria for long-term use, but may be used for demonstration –scale projects.

2 = Meets primary criteria. Land redevelopment or purpose-built marine terminal or berth required.

3 = Meets primary criteria, and some secondary criteria. Moderate level of improvements needed.

4 = Meets all primary criteria and most if not all secondary criteria. Minimal improvements needed.

A3.7 Anacortes

Existing Facilities

Located halfway between Seattle and Vancouver, British Columbia, the Port of Anacortes is a natural deep-draft port with three berths. Pier 1, with a dock-side depth of 23 ft., is home to Dakota Creek Industries, a full service shipbuilding and repair facility with dry-dock (314 x 90 ft.) and numerous cranes. Pier 1 has a yard area of 13 acres and its dock is capable of handling live loads of 400 lbs. per square foot. Pier 2, with a dock-side depth of 37 ft., is used primarily for the fabrication of dry-bulk cargo. Pier 2 has a yard area of 13 acres and its dock is capable of handling live loads of 750 lbs. per square foot. Curtis Wharf, with a dock-side depth of 24 ft., is used for periodic vessel moorage and staging areas for project cargoes, with an area of 1 acre, and has a live load capacity of 1,200 lbs.

Table A-51. Anacortes key characteristics

Characteristic	Strength	Potential Limitation
Harbor Location	Sheltered harbor	Far from BOEM waters (113 miles)
Navigation	Channel Depth = 36 ft. limiting Channel Width = N/A	-
Air Draft		39 ft. air draft at Pier 2
Upland Area	-	-Pier 1 – 13 acres Pier 2 – 13 acres Curtis Wharf – 1 acre
Crane	500 ton Module Transport System	Lifting Equipment — 260 & 175 ton Manitowoc Crawler Cranes, 150 ton P&H

Characteristic	Strength	Potential Limitation
		Crawler Crane, RT90 & 700E 60 ton Grove Cranes, 2- 18- 233 ton Kamag Transporters
Shipyard	Dakota Creek Industries. 314' x 90' – 9,000 ton lifting capacity	-
Road & Rail Access	State road access.	No interstate/Hwy access. No rail access.
Quayside Facilities	-	Berthing capacities too low for OFW construction and assembly.
Helipad	-	-
Workforce & Fabrication	Experienced marine fabricators available	-
Other	Fabrication Building — 300' x 100' – radiant heating, environmental exhaust system and 2- 10 ton overhead cranes	-

Assessment

The port was classified as a potential fabrication and construction port for OFW and MHK, and a potential assembly port for OFW and MHK. The Port of Anacortes has only one berth (Pier 2) with suitable depths (37 ft.) for most bulk carrier vessels, but has an air draft restriction of 39 ft., which would preclude these vessels, but not necessarily deck barges. Pier 2 also has adequate upland area (13 acres) for limited OFW and MHK fabrication, but not for OFW foundations. Pier 2 is currently configured primarily for dry-bulk cargo, which suggests redevelopment of the pier would be required to handle project and heavy-lift cargo. The live load bearing capacity at Pier 2 of 750 lbs. per square foot does not meet the 1000 psf. required for OFW construction and assembly. MHK construction and assembly appear feasible with the current bearing capacity at Pier 2. If constructed offsite, the port could most likely accommodate export of the device or device components, with the appropriate crane. Because of the shipbuilding and repair facilities there is a skilled workforce available. Dry dock facilities at the port (314 x 90 ft.) do not meet criteria for OFW foundation construction (175 – 230 ft. width). Curtis Wharf depths would not allow for OFW assembly with existing technology, but could accommodate some MHK technologies.

Table A-52. Anacortes port assessment and cursory gap analysis

Port Classification	Technology	Score	Potential Gap
Quick Reaction	OFW & MHK	-	N/A
Fabrication & Construction	OFW Turbine	0	Additional quayside upland area (10+ acres) and increased berth bearing capacity.
	OFW Foundation	1	Additional quayside upland area required (50+ acres) and increased berth bearing capacity.
	MHK	3	Depending on throughput requirements and location of fabrication facility (i.e. on-site, off-site). Crane/SPMT may be required
Assembly	OFW Semi-Sub	1	Additional quayside upland area required (10+ acres) and increased berth bearing capacity.
	OFW TLP	1	Additional quayside upland area required (10+ acres) and increased berth bearing capacity.

Port Classification	Technology	Score	Potential Gap
	OFW Spar	1	Additional quayside upland area required (10+ acres) and increased berth bearing capacity.
	MHK	3	Crane improvements. Berth redevelopment.

- = Was not assessed based on results of Pre-screening analysis.

0 = Does not meet criteria and is not suitable due to not meeting primary criteria.

1 = May not meet all primary criteria for long-term use, but may be used for demonstration –scale projects.

2 = Meets primary criteria. Land redevelopment or purpose-built marine terminal or berth required.

3 = Meets primary criteria, and some secondary criteria. Moderate level of improvements needed.

4 = Meets all primary criteria and most if not all secondary criteria. Minimal improvements needed.

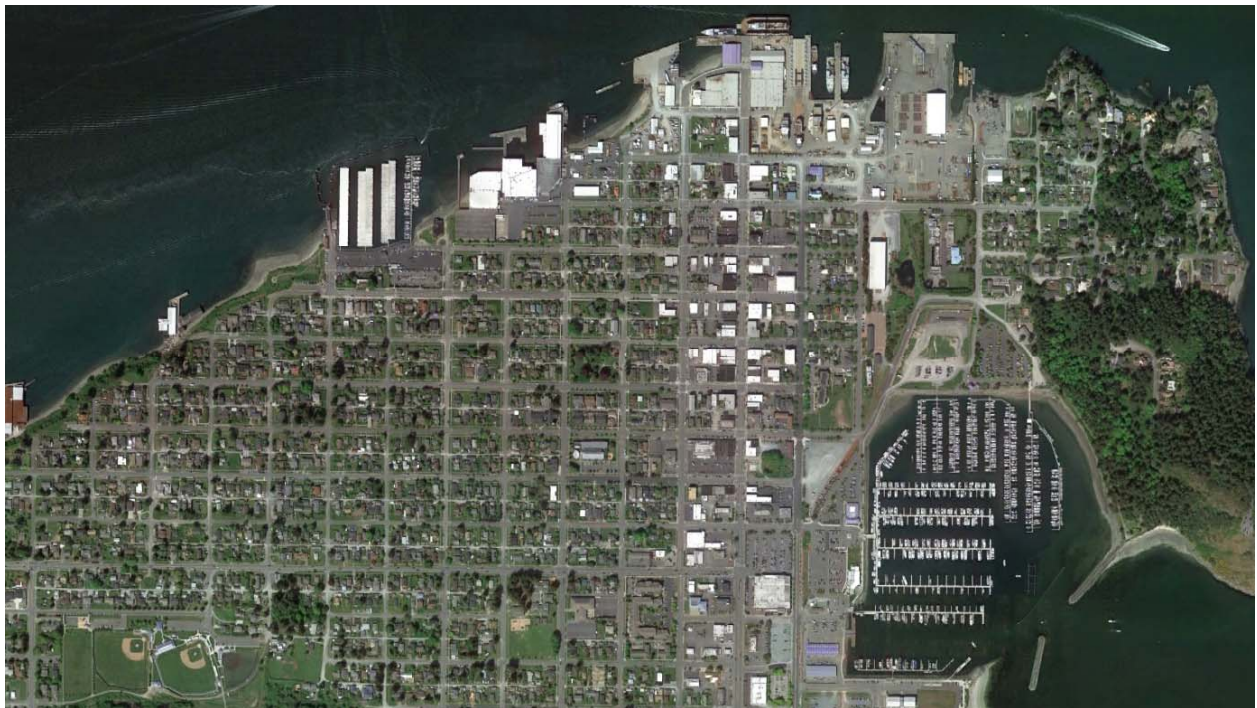

Figure A-26. Anacortes

A3.8 Everett

Existing Facilities

Located 25 miles north of Seattle on Puget Sound, the Port of Everett is a deep-draft port specializing in oversize and project cargos. The port provides an important link for Boeing as it handles parts for their jetliners. The port is on the BNSF Class 1 rail network and has easy access to Interstate 5. The port features five designated berths. South Terminal, with a yard space of 15 acres, handles conventional, breakbulk, and Ro-Ro cargo, with two berths measuring 900 and 700 ft. in length. Pacific terminal, also with a yard space of 15 acres, handles container and breakbulk cargo, with a berth length of 650 ft. and features two Panamax gantry cranes. Pier 1, with a yard space of 15 acres, handles conventional, breakbulk, Ro-Ro, and container cargoes. Pier 3, with a yard space of 13 acres, handles Bulk, breakbulk, and log cargoes. Vigor Shipyard, specializing in vessel repair and refit, sits adjacent to Pier 3 and has 7 cranes with lifting capacities up to 45 tons. The port also has a mobile crane with a 100-ton lifting capacity. In total the port owns 3,000 acres of property, 100 acres of which are the seaport.

Table A-53. Everett key characteristics

Characteristic	Strength	Potential Limitation
Harbor Location	Sheltered harbor.	Far from BOEM waters (125 miles)
Navigation	Channel Depth = 40 ft. MLLW. Channel Width = N/A, natural bay	-
Air Draft	No air draft restrictions	-
Upland Area		Existing developed port staging area is in high demand due port cargo throughput volumes. ~56 acres at the seaport terminals
Crane	150 ton mobile crane	
Shipyard	Vigor shipyard and ship repair	No dry-dock at Vigor shipyard.
Road & Rail Access	Interstate access. Class 1 rail access.	-
Quayside Facilities	-	-
Helipad	-	-
Workforce & Fabrication	Major metropolitan area. Strong supply of skilled workforce. Significant aerospace manufacturing/design presence.	-
Other	Previous experience in handling wind turbine components. Specializes in non-standard cargo.	-

Assessment

The port was classified as a fabrication and construction port for OFW and MHK, an assembly port for OFW Semi-Sub and TLP, a potential assembly port for OFW Spar, and an assembly port for MHK. The upland storage and staging areas at the Port of Everett are high use areas, with approximately 15 acres at each terminal. Each terminal’s upland areas appear to be potentially technically feasible to accommodate OFW turbine and MHK construction. However, cargo is often staged in the upland area, and the port has experience handling wind turbine components. However, designating a large sector of the land an individual terminal may not be feasible due to the throughput and storage/staging requirements from normal port operations. Demonstration-scale assembly may be feasible at the port, with a special-use crane, but commercial-scale assembly is unlikely at the port. Although ship repair facilities are available at the Vigor shipyard, they do not have dry-docks preferred for OFW foundation construction. A variety of cranes are available at the port, but suitability for handling MHK components will need to be evaluated on a case by case a basis. The port is well suited for transport of MHK components manufactured at facilities outside the port, since it specializes in non-containerized cargo.

Table A-54. Everett port assessment and cursory gap analysis

Port Classification	Technology	Score	Potential Gap
Quick Reaction	OFW & MHK	-	N/A
Fabrication & Construction	OFW Turbine	2	Purpose built facility required with new land development (10+ acres)
	OFW Foundation	2	Purpose built facility required with new land development (50+ acres)
	MHK	2	Purpose built facility required with new land development (10+ acres). Note, if components delivered from overland transport, port would likely be able to accommodate with existing infrastructure.

Port Classification	Technology	Score	Potential Gap
Assembly	OFW Semi-Sub	1	Staging area availability
	OFW TLP	1	Staging area availability
	OFW Spar	1	Staging area availability
	MHK	1	Staging area availability

- = Was not assessed based on results of Pre-screening analysis.

0 = Does not meet criteria and is not suitable due to not meeting primary criteria.

1 = May not meet all primary criteria for long-term use, but may be used for demonstration –scale projects.

2 = Meets primary criteria. Land redevelopment or purpose-built marine terminal or berth required.

3 = Meets primary criteria, and some secondary criteria. Moderate level of improvements needed.

4 = Meets all primary criteria and most if not all secondary criteria. Minimal improvements needed.

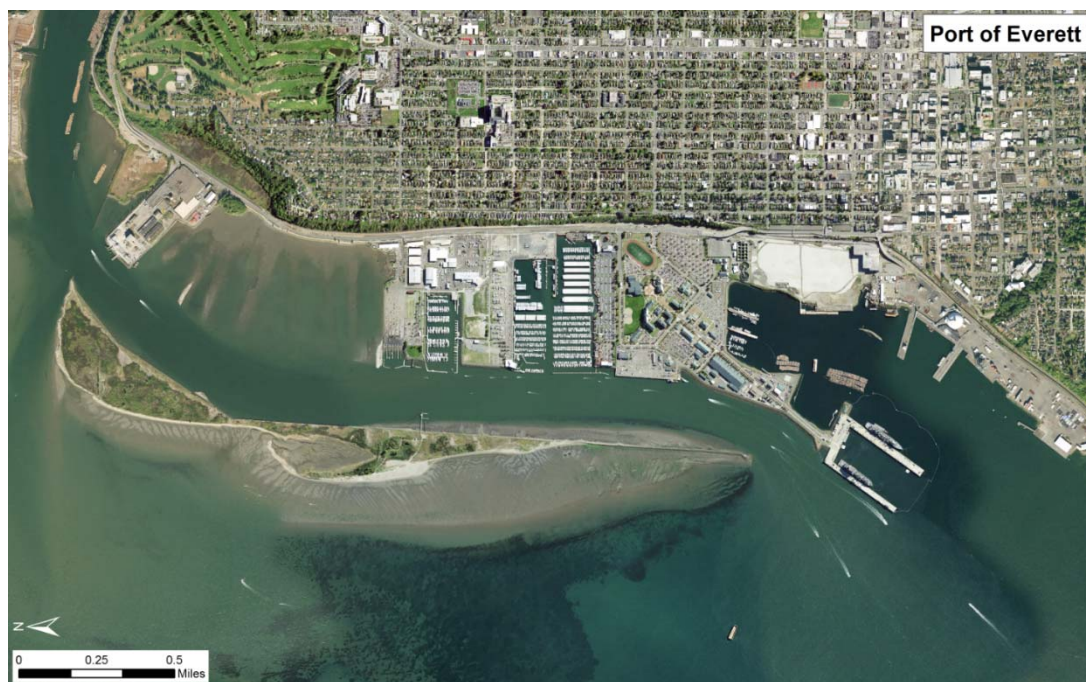

Figure A-27. Everett

A3.9 Seattle

Existing Facilities

The Port of Seattle contains 1,543 acres of waterfront land and nearby properties, and is the largest port in the state. The port is now in a partnership with Port of Tacoma, known as the Northwest Seaport Alliance. Though the port handles primary container cargo, it has over 8,000 ft. of moorage used for breakbulk cargo. The primary breakbulk terminal is located at Terminal 115, which has 70 acres of yard space, and a controlling water depth of 30 ft. MLLW. Terminal 5 is currently being used as a non-containerized terminal but is being modernized for containers. The Duwamish Waterway extends upriver of the port, but is restricted by bridges (Horizontal Clearance: 150 ft., Vertical Clearance: 150 ft.), and navigation depth (varies). Some private property may be available on the Duwamish Waterway, which includes many private barge berths, but large parcels may be difficult to obtain since the area is high-use. An example is the former Silver Bay Logging Site, which includes a barge dolphin and dock with 3 acres of land.

Vigor Shipyards has a 27-acre facility near Terminal 5. The two dry docks have a capacity of 13,000 tons and 18,000 tons. The facility has 12 cranes, with up to 150 ton capacity, and a 170,000 square foot covered fabrication and shop area. The shipyard has performed upgrades to drill rigs, including the 266 ft. x 230 ft. Kulluk semi-submersible drill rig.

Table A-55. Seattle key characteristics

Characteristic	Strength	Potential Limitation
Harbor Location	Sheltered	-
Navigation	Deep draft Puget Sound, few limitations.	-
Air Draft	Unlimited	-
Upland Area	70-200 acres of breakbulk. Other opportunities along Duwamish.	Terminal 5 (~200 acres) planned to be converted to container.
Crane	Float cranes	- 155 ton mobile crane
Shipyard	Vigor Shipyards. 2 dry docks with a maximum width of 93 ft..	-
Road & Rail Access	Interstate and Class 1 Rail	-
Quayside Facilities	600 psf, 103 ft. wide apron at Terminal 115.	-
Helipad		-
Workforce & Fabrication	Shipyard and other manufacturing facilities area available in region.	-
Other	-	In general quayside facilities are high use with limited areas available.

Assessment

The port was classified as a fabrication and construction port for OFW and MHK, an assembly port for OFW Semi-Sub and TLP, a potential assembly port for OFW Spar, and an assembly port for MHK. The Port of Seattle has a strong manufacturing base, deep-water access, and no height restrictions, and so if upland area became available seaward of the West Seattle Bridge, the port would be a good candidate for supporting OFW fabrication and construction as well as assembly. Terminal 5 would be a potential location to construct and assemble OFW foundations and turbines, with support by Vigor Shipyards. Though the existing dry-docks at this Vigor location would not likely meet the size requirements for OFW, they would meet the requirements for some MHK technologies. A large floating dry-dock, similar to the Vigorous in Portland could potentially be located near Terminal 5 to support construction. In order to assemble the devices and stage the components, a significant portion of Terminal 5 may be required. A precedent for servicing floating units of this size in the Port was set by the Kulluk oil rig. It is possible that assembly could occur in the West Waterway (width ~800 ft.). The most critical potential limitation at Port of Seattle is available upland area. Based on existing technology, it appears that depths outside the Port may be available for assembly of Spars, depending on ballast, though a detailed up-righting and transit study would be required. If constructed off-site and transported overland, MHK component export could likely be accommodated, with the appropriate crane.

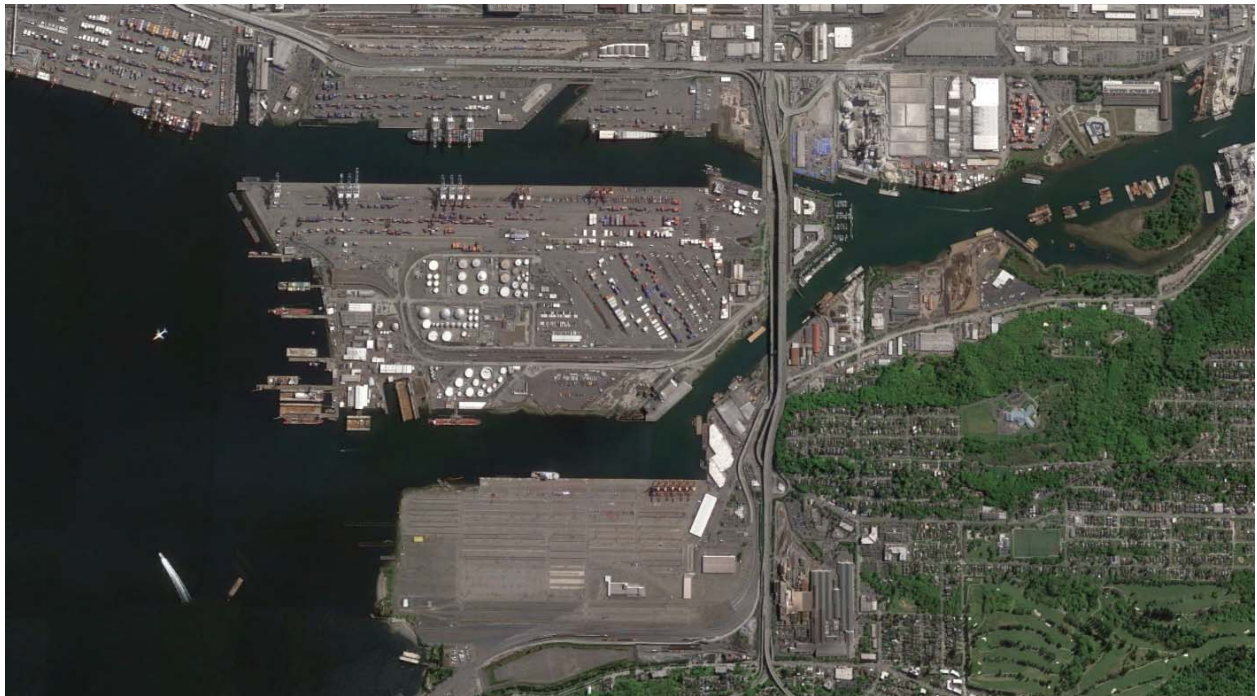

Figure A-28. Seattle

Table A-56. Seattle port assessment and cursory gap analysis

Port Classification	Technology	Score	Potential Gap
Quick Reaction	OFW & MHK	-	N/A
Fabrication & Construction	OFW Turbine	2	Purpose built facility required (berth, upland development). Area is potentially limited if Terminal 5 is converted to container cargo.
	OFW Foundation	2	Purpose built facility required (berth, upland development). Area is potentially limited if Terminal 5 is converted to container cargo.
	MHK	3	Depending on throughput requirements and location selection. Crane/SPMT may be required
Assembly	OFW Semi-Sub	2	Exclusive use facility. Redevelopment of a portion of Terminal 5, including wharf strengthening.
	OFW TLP	2	Exclusive use facility. Redevelopment of a portion of Terminal 5, including wharf strengthening.
	OFW Spar	2	Floating Crane or new Spar assembly technology may be required.
	MHK	3	Crane/SPMT may be required. Berth bearing capacity investigation may be required.

- = Was not assessed based on results of Pre-screening analysis.

0 = Does not meet criteria and is not suitable due to not meeting primary criteria.

1 = May not meet all primary criteria for long-term use, but may be used for demonstration –scale projects.

2 = Meets primary criteria. Land redevelopment or purpose-built marine terminal or berth required.

3 = Meets primary criteria, and some secondary criteria. Moderate level of improvements needed.

4 = Meets all primary criteria and most if not all secondary criteria. Minimal improvements needed.

A3.10 Tacoma

Existing Facilities

The port was classified as a fabrication and construction port for OFW and MHK, an assembly port for OFW Semi-Sub and TLP, a potential assembly port for OFW Spar, and an assembly port for MHK. The Port of Tacoma contains approximately 820 acres of terminal area, and through its partnership with the Port of Seattle, known as the Northwest Seaport Alliance, is part of the largest port in Washington State. Like Seattle the port handles primary container cargo, but has 53 acres of land area and 7,400 ft. of moorage for breakbulk cargoes. Primary breakbulk cargo operations occur at the East Blair Terminal which has 25 acres of upland area, 1,100 ft. of moorage, and a 51 ft. berth depth. East Blair Terminal has on-dock rail service with connection to Class 1 rail networks. There are no air draft concerns to any of the ports major container or breakbulk terminals, except for the West Hylebos Facility. Several other port properties are available for lease with water access (Port of Tacoma, 2016), such as 1203 East D street (20 acres), 1171 Taylor Way (20 acres), 3009 Taylor Way (12 acres). Vigor Shipyards has a 5-acre facility at the APM Terminal.

Table A-57. Tacoma key characteristics

Characteristic	Strength	Potential Limitation
Harbor Location	Sheltered	-
Navigation	Deep draft Puget Sound (>300 ft.) Blair Waterway: ~49 ft. Hylebos Waterway: ~27 ft. Thea Foss Waterway: ~30 ft.	-
Air Draft	Unlimited	-
Upland Area	Multiple terminals with 12 – 25 acres upland area. Waterside properties for lease ranging between 10-20 acres each.	-
Crane	-	55 ton cranes at Vigor Shipyard. 155 ton mobile crane.
Shipyard	40,000 sq. ft. shop area for fabrication and vessel upgrades (Vigor)	No dry-dock
Road & Rail Access	Interstate Access. Class 1 rail access	-
Quayside Facilities	1200 ft. at East Blair Terminal	Terminal hours of operation are typically Mon-Fri.
Helipad		N/A
Workforce & Fabrication	Shipyard and other manufacturing facilities area available in region.	-
Other	Numerous properties with developable land. Some are graveled for heavy lift	In general quayside facilities are high use with limited areas available.

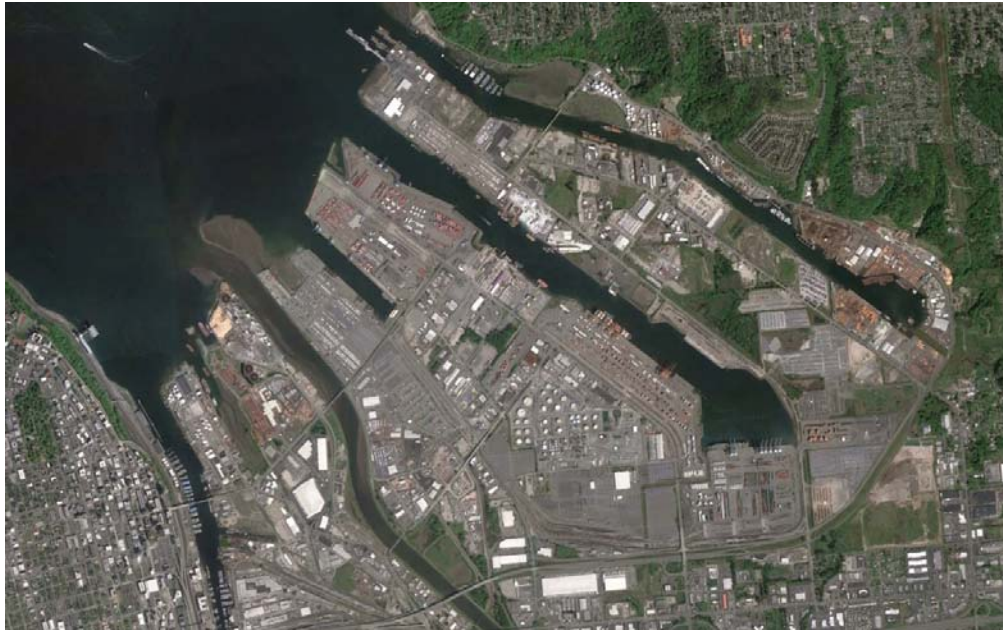

Figure A-29. Tacoma

Assessment

The Port of Tacoma has a strong manufacturing base, deep-water access, and no height restrictions, therefore upland area became available, the port would be a good candidate for supporting fabrication, construction, and assembly operations. Of the existing terminals, East Blair Terminal is likely the best candidate for OFW turbine construction, or MHK construction and assembly. It has with 25 acres of upland space total, but also must accommodate other cargo such as autos, which would affect long-term use potential. The numerous other properties owned by the port have good potential to be developed, and have adequate area to potentially construct OFW and MHK component fabrication facilities. Construction of an OFW foundation fabrication facility is feasible, though available space may restrict throughput to demonstration-scale without additional land development or terminal re-purposing. Assembly operations in one of the navigation channels could be compromised by the current high traffic of cargo vessels through the port, since the waterway width is restricted and the device width could be approximately 175 ft. wide. However, based on existing technology, it appears that depths outside (i.e. Commencement Bay) the Port can accommodate assembly of OFW devices with a water based crane, including Spars (depending on ballast, though a detailed up-righting and transit study would be required).

Table A-58 Tacoma port assessment and cursory gap analysis

Port Classification	Technology	Score	Potential Gap
Quick Reaction	OFW & MHK	-	N/A
Fabrication & Construction	OFW Turbine	3	Land-use change from terminal storage to manufacturing, Berth bearing capacity investigation may be required.
	OFW Foundation	2	Upland area development size, channel width may preclude certain technologies.
	MHK	3	Berth bearing capacity investigation may be required.
Assembly	OFW Semi-Sub	2	May require crane barge. New supporting staging facilities required on land for all components.

Port Classification	Technology	Score	Potential Gap
	OFW TLP	2	May require crane barge. New supporting staging facilities required on land for all components.
	OFW Spar	2	May require crane barge. New supporting staging facilities required on land for all components.
	MHK	3	

- = Was not assessed based on results of Pre-screening analysis.

0 = Does not meet criteria and is not suitable due to not meeting primary criteria.

1 = May not meet all primary criteria for long-term use, but may be used for demonstration –scale projects.

2 = Meets primary criteria. Land redevelopment or purpose-built marine terminal or berth required.

3 = Meets primary criteria, and some secondary criteria. Moderate level of improvements needed.

4 = Meets all primary criteria and most if not all secondary criteria. Minimal improvements needed.

A3.11 Olympia

Existing Facilities

The port of Olympia, located at the head of Puget Sound, is a busy 66 acre terminal facility with three (3) deep draft berths and an 800 ft. wide turning basin. Long-term leases at the port (Port of Olympia, 2015) include Weyerhaeuser (24.5 acres) and PLS (10.6 acres). The port is located one mile from interstate-5 and has on-dock rail service with connection to both the Union Pacific and BNSF Class 1 rail networks. On-site container, bulk, and breakbulk yard handling equipment, including top-picks, yard tractors, yard chassis, front-end bucket loaders, forklifts, and log handlers (Port of Olympia, 2015). Vessels of at least 500 ft. LOA are currently accommodated by port facilities. Access to the Pacific Ocean requires transit under the Tacoma Narrows Bridge (vertical clearance of 179 ft.).

Table A-59. Tacoma key characteristics

Characteristic	Strength	Potential Limitation
Harbor Location	Protected. Puget Sound	-
Navigation	30 ft. MLLW Channel	-
Air Draft		179 ft.
Upland Area	76,000 sq. ft. warehouse	66 acres total.
Crane	-	155 ton mobile crane
Dry Dock	-	N/A
Road & Rail Access	Class 1 Rail, one mile from Interstate Highway and	-
Quayside Facilities	load capacities of 1,000 psf. Berth depths of 39 ft.	-
Helipad	-	No
Workforce & Fabrication	-	-
Other	Experience with wind farm components. 24/7 operation.	-



Figure A-30. Olympia

Assessment

Because of limited upland area due to long-term leases, and existing port needs it's not likely that MHK assembly and staging facilities on site would be likely to fit at the marine terminal. Depending on MHK type, the port may be able to provide as an MHK export facility if components are constructed off site. The Tacoma Narrows Bridge does not allow for assembly inland of bridge.

Table A-60. Olympia port assessment and cursory gap analysis

Port Classification	Technology	Score	Potential Gap
Quick Reaction	OFW & MHK	-	N/A
	OFW Turbine	-	N/A
Fabrication & Construction	OFW Foundation	-	N/A
	MHK	3	Crane/SPMT. Berth bearing capacity investigation.
Assembly	OFW Semi-Sub	-	N/A
	OFW TLP	-	N/A
	OFW Spar	-	N/A
	MHK	0	Not enough upland area with marine access

- = Was not assessed based on results of Pre-screening analysis.

0 = Does not meet criteria and is not suitable due to not meeting primary criteria.

1 = May not meet all primary criteria for long-term use, but may be used for demonstration –scale projects.

2 = Meets primary criteria. Land redevelopment or purpose-built marine terminal or berth required.

3 = Meets primary criteria, and some secondary criteria. Moderate level of improvements needed.

4 = Meets all primary criteria and most if not all secondary criteria. Minimal improvements needed.

A3.12 Bellingham

Existing Facilities

The Port of Bellingham, located on Puget Sound approximately 70 miles north of Seattle, specializes in break bulk and clean bulk cargoes. The port's deep water berth has a total length of 1250 ft. and 15 acres of upland staging area located at the shipping terminal with an additional 20 acres at a nearby log yard. The port also provides cruise terminal facilities. Dry-dock facilities are available at Fairhaven Shipyard, including a 107 by 460 ft. semi-submersible dry-dock. Industrial fabrication capabilities are also available within 10 miles of the port, such as Greenberry Industrial. No crane infrastructure appears to exist at the port berths. There is on-site Class 1 rail access and direct access to I-5 is within 2 miles of the port.

Table A-61. Bellingham key characteristics

Characteristic	Strength	Potential Limitation
Harbor Location	Sheltered harbor.	Far from BOEM waters (133 miles).
Navigation	Channel Depth = 32 ft. Channel Width = open navigation Deep-draft berth available.	-
Air Draft	No air draft	-
Upland Area	35 acres	-
Crane		140 ton crane capacity
Dry Dock	Fairhaven Shipyard Dry-dock: 130 ft. by 470 ft.	-
Road & Rail Access	Interstate access. Class 1 rail access.	-
Quayside Facilities	-	-
Helipad	-	-
Workforce & Fabrication	Skilled workforce with fabrication capabilities nearby.	-
Other	-	-

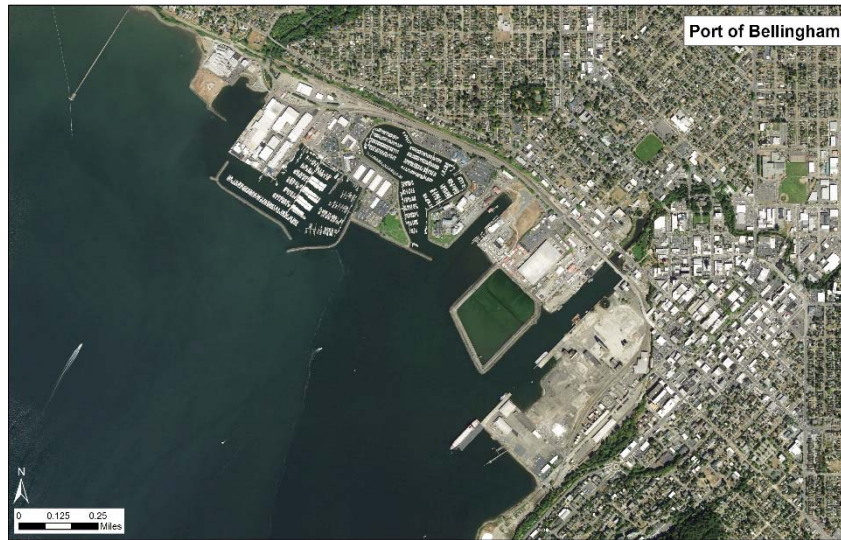

Figure A-31. Bellingham

Assessment

The port was classified as a potential fabrication and construction port for OFW, a fabrication and construction port for MHK, and a potential assembly port for MHK. Rail and road access are sufficient for fabrication and construction, as well as assembly operations. Upland staging areas appear adequate for OFW Turbine construction, MHK construction, and MHK assembly (35 acres available total), but likely will preclude OFW foundation construction on site. There are no air draft restrictions at the port and the port is capable of servicing vessels at least 500 ft. in length, with few if any vessel navigation restrictions anticipated associated with IEP and AP operations. The presence of industrial fabrication contractors near the port demonstrates the presence of a skilled workforce. Current dry dock facilities (107 by 460 ft.) do not meet the possible width (175 – 230 ft.) and length (300 ft.) required by OFW foundation units. A purpose built crane would be required at the port to support OFW assembly. Berthing capacity at the port berths needs further investigation.

Table A-62. Bellingham port assessment and cursory gap analysis

Port Classification	Technology	Score	Potential Gap
Quick Reaction	OFW & MHK	-	N/A
	OFW Turbine	3	Crane upgrades or SPMT/Barge required. Berth bearing capacity investigation may be required.
Fabrication & Construction	OFW Foundation	1	Additional upland staging required. Berth bearing capacity investigation may be required. Crane/SPMT required.
	MHK	3	Crane upgrades or SPMT/Barge required. Additional upland staging required. Berthing capacity unknown.
Assembly	OFW Semi-Sub	-	N/A
	OFW TLP	-	N/A
	OFW Spar	-	N/A
	MHK	3	Crane upgrades required.

- = Was not assessed based on results of Pre-screening analysis.

0 = Does not meet criteria and is not suitable due to not meeting primary criteria.

1 = May not meet all primary criteria for long-term use, but may be used for demonstration –scale projects.

2 = Meets primary criteria. Land redevelopment or purpose-built marine terminal or berth required.

3 = Meets primary criteria, and some secondary criteria. Moderate level of improvements needed.

4 = Meets all primary criteria and most if not all secondary criteria. Minimal improvements needed

A.4. Hawaii

A4.1 Honolulu

Existing Facilities

The Port of Honolulu, located on the southern shore on the Hawaiian Island Oahu, is a 200 acre facility with 30 berths and over five miles of total berth length. Break-bulk cargo handling is done at Piers 39 and 40 (Inter-island cargo terminal), with yard areas of 16.1 and 10.8 acres respectively. All other piers primarily accommodate container cargo, cruise terminals, commercial fishing, liquid and dry bulk cargo, Ro-Ro, and pipeline cargo; these piers (other than 39 and 40) have an average yard area of approximately 5 acres and operate close to or at their current capacity. Both Pier 39 and 40 have a berth depth of 30 ft. (MLLW). Piers 24-29 also handle general cargo, and have depths between approximately 30-35 ft., with upland area between half an acre to 8 acres. The port accommodates vessels of at least 500 ft. in length. Small passenger and miscellaneous vessels are accommodated out of Piers 5, 6, 8, and 9 with berth lengths of 200 to 630 ft. and berth depths of 15 to 34 ft. Sand Island (Piers 51-53) is the largest terminal by size, and is used primarily for autos and domestic containers. Pacific Shipyards at Pier 41 has dry-docks, ship repair facilities with a draft of 22 – 34 ft. (MLLW), and two 50-ton mobile cranes on-site. Dry-dock facilities are also potentially available at BAE Systems Ship Repair in Pearl Harbor, which appear to be navy oriented, and is currently executing a seven-year multi-ship contract (BAE, 2016). There are several crane and rigging companies on the island with cranes for rent up to at least approximately 250 tons. Cranes have been used to construct smaller component on-land windfarms on the island.

Table A-63. Honolulu key characteristics

Characteristic	Strength	Potential Limitation
Harbor Location	Sheltered harbor near BOEM waters	-
Navigation	Channel width = 400 ft. Channel Depth = 40 ft. Port accommodates vessels >=500 ft.	-
Air Draft	No air draft restriction.	-
Upland Area	Pier 39 - 16.1 acres (breakbulk) Pier 40 - 10.8 acres (breakbulk)	-
Crane	-	Mobile cranes for rental ~250 tons.
Shipyard	Pearl Harbor and Dry dock is (~1000 x 150 ft.) and Pacific Shipyards.	-
Road & Rail Access	-	No mainland USA Rail & Road access
Quayside Facilities	-	30 ft. berth depth at existing breakbulk terminal
Helipad	Helipad nearby at Honolulu Airport	No helipad on-site
Workforce & Fabrication	Large marine industry workforce with Naval Shipyard, metropolitan population	-
Other	-	-

Assessment

The port was classified as a QRP for OFW and MHK, a potential fabrication and construction port for OFW and MHK, and as a potential assembly port for OFW Semi-Sub, TLP, and an assembly port for MHK. The close proximity of the Port of Honolulu to potential BOEM water makes it well positioned as a QRP. Current accommodation of vessels 500 ft. or longer suggest few (if any) navigation restrictions are anticipated associated with QR, IEP, and AP vessel operations. Safe navigation width for OFW Semi-Sub units may approach or exceed

the limiting width of the navigation entrance channel (400 ft.) depending on the specific technology requirements and tug selection. Existing berth depth at the bulk cargo terminal would likely be sufficient for OFW turbine marine towing, but without the turbine affixed. With the turbine affixed existing depths at the berth may require additional mitigation for device draft. In general the port is a dense, high-use facility with limited available property for fabrication or commercial-scale land-based assembly. Yard areas at piers 39 and 40 are technically large enough for fabrication for a portion of OFW components, or MHK construction and assembly, but would require exclusive use of a majority of the marine facilities used for inter-island cargo, which is not feasible. The area requirement for OFW foundation construction does not appear to allow construction at the port, depending on throughput. Depending on project timeline, assembly method, and throughput, demonstration-scale assembly of the devices may be possible within the port. Dry-dock width at Pacific shipyard (105 ft.) is less than the requirements of OFW foundations for Spar, Semi-Sub, and TLP technology (175 -300 ft.). Crane procurement or rental appears to be required for heavy lift during construction and/or assembly operations. It is assumed that fabrication and assembly is not feasible on military property.

Table A-64. Honolulu port assessment and cursory gap analysis

Port Classification	Technology	Score	Potential Gap
Quick Reaction	OFW & MHK	4	No major gaps. Vessel specific moorage may be required.
	OFW Turbine	0	Exclusive use upland area (10+ acres minimum)
Fabrication & Construction	OFW Foundation	1	Exclusive use upland area (50+ acres depending on throughput). Demonstration-scale area is temporary.
	MHK	3	Crane/SPMT upgrades likely required and long-term exclusive use berth lease obtained.
Assembly	OFW Semi-Sub	1	Exclusive use upland area (10-15 acres minimum) for purpose-built development
	OFW TLP	1	Exclusive use upland area (10-15 acres minimum) for purpose-built development
	OFW Spar	-	N/A
	MHK	1	Exclusive use upland area (10 acres) for purpose-built development

- = Was not assessed based on results of Pre-screening analysis.

0 = Does not meet criteria and is not suitable due to not meeting primary criteria.

1 = May not meet all primary criteria for long-term use, but may be used for demonstration –scale projects.

2 = Meets primary criteria. Land redevelopment or purpose-built marine terminal or berth required.

3 = Meets primary criteria, and some secondary criteria. Moderate level of improvements needed.

4 = Meets all primary criteria and most if not all secondary criteria. Minimal improvements needed.



Figure A-32. Honolulu

A4.2 Barbers Point

Existing Facilities

Port of Barber’s Point is located on the southwest corner of the Hawaiian Island Oahu and services specialized cargo needs not found at the Port of Honolulu. The port currently has 6 berths in its current configuration: a barge basing, a ferry/tug pier, Pier P-3, P-5, P-6, and P-7. The barge basin handles liquid bulk cargo and pipelines, as well as scrap metal and sand cargo. Pier P-3 is the former berth for a dry-dock facility. Pier P-5 handles neo-bulk, liquid-bulk, petroleum, and scrap metal cargo. Pier P-6 handles neo-bulk, dry-bulk, liquid-bulk, and scrap metal cargo. Pier P-7 handles dry bulk cargo. The berths have dock-side storage areas ranging from 3.1 to 30 acres. As part of the port’s 2040 Master Plan, the Port of Barber’s Point has zoned 23 acres of land for development of maritime support services, as well as 30 acres of multi-purpose yard space. There appears to be no crane infrastructure currently at the port. There is no helipad at the port but helicopter facilities appear to be available nearby at Kalaeloa Airport.

Table A-65. Barbers Point key characteristics

Characteristic	Strength	Potential Limitation
Harbor Location	Sheltered harbor near BOEM waters	-
Navigation	Channel width = 400 ft. Channel Depth = 40 ft. Port accommodates vessels >=500 ft.	-
Air Draft	No air draft.	-

Characteristic	Strength	Potential Limitation
Upland Area	Barge Basin – 4.4 acres, P-5 – 4.7 acres, P-6 – 30 acres, P-7 – 3.1 acres. Additional Upland area zoned (~50 acres)	-
Crane		No crane
Shipyard	Honolulu facilities ~20 miles away.	No dry dock
Road & Rail Access	-	No mainland USA Rail & Road access
Quayside Facilities	Barge basin: ~16 ft. depth P-3 – P7, ~38 ft.	Bearing capacity not defines.
Helipad	Helipad nearby at Kalaeloa Airport	No helipad on-site
Workforce & Fabrication	-	-
Other	-	-

Assessment

The port was classified as a QRP for OFW and MHK, a potential fabrication and construction port for OFW and MHK and as a potential assembly port for OFW Semi-Sub, TLP, and MHK. The close proximity of the Port of Barber’s Point to potential BOEM water makes it well positioned as a QRP. Current accommodation of vessels 500 ft. or larger suggest few (if any) navigation restrictions are anticipated associated with QR, IEP, and AP vessel operations. New cranes will be required for heavy lifts during construction and/or assembly operations. Pier 6 has 30 acres of yard area which would be able to support fabrication of an OFW turbine component. MHK construction and assembly, but may restrict throughput for OFW foundation construction. However, if available, the additional 50+ acres currently zoned by the port for maritime support services and multi-purpose yard space could potentially be used for OFW foundation construction operations, but would require significant material import to the island. No dry-dock facilities are currently at the port, but dry-docks have been previously situated in the port suggesting suitable berthing for dry-docks and a local supply of a skilled workforce.

Table A-66. Barber’s Point port assessment and cursory gap analysis

Port Classification	Technology	Score	Potential Gap
Quick Reaction	OFW & MHK	4	No major gaps. Vessel specific moorage may be required.
	OFW Turbine	2	High bearing capacity quayside area, with staging area development (10+ acres) with Crane or SPMT.
Fabrication & Construction	OFW Foundation	2	High bearing capacity quayside area, with staging area development (50+ acres) with Crane or SPMT
	MHK	3	Quayside bearing capacity investigation, with new crane or SPMT
Assembly	OFW Semi-Sub	2	No dry-dock
	OFW TLP	2	
	OFW Spar	-	N/A
	MHK	3	Quayside bearing capacity investigation, with new crane or SPMT

- = Was not assessed based on results of Pre-screening analysis.

0 = Does not meet criteria and is not suitable due to not meeting primary criteria.

1 = May not meet all primary criteria for long-term use, but may be used for demonstration –scale projects.

2 = Meets primary criteria. Land redevelopment or purpose-built marine terminal or berth required.

3 = Meets primary criteria, and some secondary criteria. Moderate level of improvements needed.

4 = Meets all primary criteria and most if not all secondary criteria. Minimal improvements needed.



Figure A-33. Barbers Point

A4.3 Kahului

Existing Facilities

Located on the north shore of the Hawaiian Island Maui, the Port of Kahului Harbor is the only commercial harbor on the island. The port is a 45 acre secured facility with three (3) piers, handling container, liquid and dry bulk, Ro-Ro, and break bulk cargo. Pier 1 is primarily used by tenants Matson, Pasha, and cruise vessels. Pier 1 has 23 acres of upland area used for container handling and storage. Piers 2 and 3 have a combined storage area of approximately 21 acres. Pier 2 (2A, 2B, 2C) provides facilities for container and cement and propane handling. Young Brothers, a Hawaiian inter-island shipping company, currently uses Pier 2 but at limited efficiency as a result of Pier 2B being unable to support forty-ton lifts. Pier 3 supports bulk cargo and fuel operations. There appears to be no permanent crane infrastructure at any of the piers at the Port of Kahului Harbor. There is no helipad at the port but helicopter facilities appear to be available nearby at Kahului Airport. The port is currently called on by vessels of at least 500 ft. in length.

Table A-67. Kahului key characteristics

Characteristic	Strength	Potential Limitation
Harbor Location	Sheltered harbor near BOEM waters	-
Navigation	Channel width = 660 ft. Channel Depth = 35 ft. Port accommodates vessels \geq 500 ft.	-
Air Draft	No air draft	-
Upland Area	44 acres total (Pier 1 – 21 acres, Pier 2 & 3 – 21 acres)	-
Crane	-	No permanent crane
Dry Dock	-	No dry-dock

Characteristic	Strength	Potential Limitation
Road & Rail Access	-	No mainland USA Rail & Road access
Quayside Facilities	-	Exact bearing capacities unknown
Helipad	Helipad at Kahului Airport	No on-site helipad
Workforce & Fabrication	-	Small population
Other	-	-

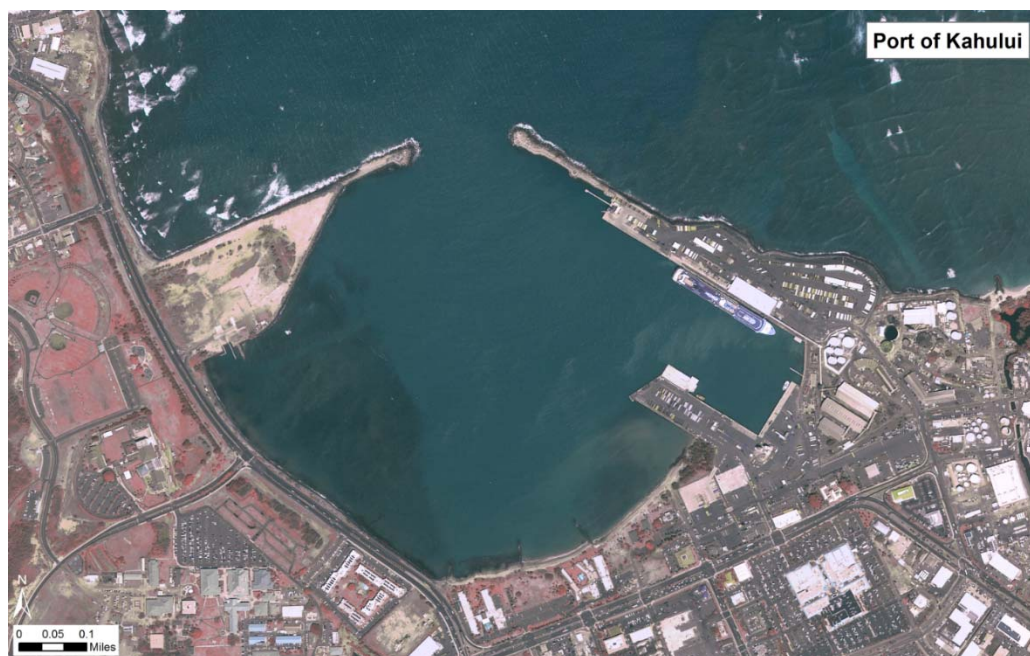

Figure A-34. Kahului

Assessment

The port was classified as a QRP for OFW and MHK, a potential fabrication and construction port for OFW and MHK and as a potential assembly port for OFW Semi-Sub, TLP, and MHK. The close proximity of the Port of Kahului to potential BOEM water makes it well positioned as a QRP. Purpose built berths for CTVs may be required. Current accommodation of vessels 500 ft. or larger suggest few (if any) navigation restrictions are anticipated associated with QR, IEP, and AP operations. There are no air draft clearance concerns at the port. Although all three piers have a combined upland storage area of approximately 40 acres, most of these areas appear to be in heavy use by current port tenants Pasha and Young Brothers and to import necessary island supplies. It is unlikely that upland areas would be available to long-term construction and assembly operations.

Table A-68. Kahului port assessment and cursory gap analysis

Port Classification	Technology	Score	Potential Gap
Quick Reaction	OFW & MHK	4	No major gaps. Vessel specific moorage may be required.
Fabrication & Construction	OFW Turbine	1	Additional quayside upland area. Crane upgrades required. Bearing capacity upgrades
	OFW Foundation	1	Additional quayside upland area. Crane upgrades required. Bearing capacity upgrades likely.

Port Classification	Technology	Score	Potential Gap
	MHK	1	Additional quayside upland area. Crane upgrades required. Bearing capacity upgrades likely.
	OFW Semi-Sub	1	Additional quayside upland area. Crane upgrades required. Bearing capacity upgrades likely.
Assembly	OFW TLP	1	Additional quayside upland area. Crane upgrades required. Bearing capacity upgrades likely.
	OFW Spar	-	N/A
	MHK	1	Limited upland availability. Crane upgrades required. Bearing capacity upgrades likely.

- = Was not assessed based on results of Pre-screening analysis.

0 = Does not meet criteria and is not suitable due to not meeting primary criteria.

1 = May not meet all primary criteria for long-term use, but may be used for demonstration –scale projects.

2 = Meets primary criteria. Land redevelopment or purpose-built marine terminal or berth required.

3 = Meets primary criteria, and some secondary criteria. Moderate level of improvements needed.

4 = Meets all primary criteria and most if not all secondary criteria. Minimal improvements needed.

A4.4 Nawiliwili

Existing Facilities

Located on the southeast coast of the Hawaiian Island Kauai, the Port of Nawiliwili Harbor has 3 piers; the port is also home to the Nawiliwili Small Boat Harbor. The existing terminals are used for inter-island cargo, petroleum storage, cement storage, and a container terminal. The inter-island terminal includes a RO-RO facility. There is no helipad at the port but helicopter facilities appear to be available at the nearby Lihue Airport. The port is currently called on by vessels of at least 500 ft. in length. Upland storage areas appear to be used currently for container storage and port parking.

Table A-69. Nawiliwili key characteristics

Characteristic	Strength	Potential Limitation
Harbor Location	Sheltered harbor near BOEM waters	-
Navigation	Channel width = 600 ft. Channel Depth = 36 ft. Port accommodates vessels >=500 ft.	-
Air Draft	No air draft	-
Upland Area	Piers 1, 2, and 3 have yard areas of 20.5, 2.6, and 16.6 acres respectively.	Upland areas exists but appears limited in availability
Crane	-	No crane infrastructure
Shipyard	-	No shipyard facilities
Road & Rail Access	-	No mainland USA Rail & Road access
Quayside Facilities	berth length over 1,800 ft. Pier-side depths are 35 ft.	-
Helipad	Helipad nearby at Lihue Airport	No on-site helipad
Workforce & Fabrication	-	Small population.
Other	-	-

Assessment

The port was classified as a QRP for OFW and MHK, a potential fabrication and construction port for OFW and MHK and as a potential assembly port for OFW Semi-Sub, TLP, and MHK. The close proximity of the Port of Nawiliwili to potential BOEM water makes it well positioned as a QRP. Current accommodation of vessels 500 ft. or larger suggest few (if any) navigation restrictions are anticipated associated with QR, IEP, and AP operations. The Nawiliwili Small Boat Harbor may be able to accommodate quick response vessels or provide a suitable setting for such purpose built CTV berths. Upland staging areas required for construction and assembly operations are limited due to other port uses. Crane infrastructure appears to be required for quick response, construction, and assembly port operations.

Table A-70. Nawiliwili port assessment and cursory gap analysis

Port Classification	Technology	Score	Potential Gap
Quick Reaction	OFW & MHK	4	No major gaps. Vessel specific moorage may be required.
	OFW Turbine	1	Additional quayside upland area. Crane upgrades required. Quayside bearing capacity investigation.
Fabrication & Construction	OFW Foundation	1	Additional quayside upland area. Crane upgrades required. Quayside bearing capacity investigation.
	MHK	1	Additional quayside upland area. Crane upgrades required. Quayside bearing capacity investigation.
Assembly	OFW Semi-Sub	1	Additional quayside upland area. Crane upgrades required. Quayside bearing capacity investigation.
	OFW TLP	1	N/A
	OFW Spar	-	N/A
	MHK	1	Limited upland availability. Crane upgrades required. Quayside bearing capacity investigation.

- = Was not assessed based on results of Pre-screening analysis.

0 = Does not meet criteria and is not suitable due to not meeting primary criteria.

1 = May not meet all primary criteria for long-term use, but may be used for demonstration –scale projects.

2 = Meets primary criteria. Land redevelopment or purpose-built marine terminal or berth required.

3 = Meets primary criteria, and some secondary criteria. Moderate level of improvements needed.

4 = Meets all primary criteria and most if not all secondary criteria. Minimal improvements needed.



Figure A-35. Nawiliwii

A4.5 Port Allen

Existing Facilities

Located on the south shore on Hawaiian Island Kauai, Port Allen Harbor is the second commercial harbor available on the island with 2 berths situated on either side of a single pier. The port has approximately 0.7 acres of upland storage area available. Primary cargoes for the port include liquid-bulk cargo and pipelines, as well as mooring for military vessels and charter boats. The port also houses the Port Allen Small Boat Harbor. The port is currently called on by vessels of at least 500 ft. in length.

Table A-71. Port Allen key characteristics

Characteristic	Strength	Potential Limitation
Harbor Location	Sheltered harbor near BOEM waters	-
Navigation	Channel width = 500 ft. Channel Depth = 35 ft. Port accommodates vessels ≥ 500 ft.	-
Air Draft	No air draft	-
Upland Area	-	Limited upland area available
Crane	-	There appears to be no crane infrastructure
Dry Dock	-	No dry dock
Road & Rail Access	-	No mainland USA Rail & Road access
Quayside Facilities	-	-
Helipad	Helipad nearby at Port Allen Airport	-
Workforce & Fabrication	-	-
Other	-	-

Assessment

The port was classified as a QRP for OFW and MHK. The close proximity of the Port Allen to potential BOEM water makes it well positioned as a QRP. Current accommodation of vessels 500 ft. LOA suggest few (if any) navigation restrictions are anticipated associated with QRP operations since quick response CTVs are anticipated to be on the order of 70 ft. in length. Purpose built crane infrastructure appears to be required for quick response operations. The 0.7 acre of upland storage does not meet the required criteria of 1-2 acres for QRPs. Purpose built berths for CTVs may be required.

Table A-72. Port Allen port assessment and cursory gap analysis

Port Classification	Technology	Score	Potential Gap
Quick Reaction	OFW & MHK	3	Vessel specific moorage may be required. Limited upland area may require redevelopment.
Fabrication & Construction	OFW Turbine	-	
	OFW Foundation	-	
	MHK	-	
Assembly	OFW Semi-Sub	-	
	OFW TLP	-	
	OFW Spar	-	
	MHK	-	

- = Was not assessed based on results of Pre-screening analysis.

0 = Does not meet criteria and is not suitable due to not meeting primary criteria.

1 = May not meet all primary criteria for long-term use, but may be used for demonstration –scale projects.

2 = Meets primary criteria. Land redevelopment or purpose-built marine terminal or berth required.

3 = Meets primary criteria, and some secondary criteria. Moderate level of improvements needed.

4 = Meets all primary criteria and most if not all secondary criteria. Minimal improvements needed.



Figure A-36. Port Allen

Appendix B. West Coast and Hawaii Port Database

STATE	PORT	Nav. Depth (ft.)	Nav. Width (ft.)	Regional Height Limit (ft.)	Proximity to BOEM Waters	Potential Upland Area (acres) w/Marine Access
California	San Diego	42	600	999	3	135
California	Los Angeles	53	750	999	3	1600
California	Long Beach	76	600	999	3	1600
California	Hueneme	35	333	999	3	130
California	Oakland	50	480	190	14	771
California	Richmond	38	500	220	16	130
California	San Francisco	38	600	190	12	76
California	Humboldt Bay	38	400	999	3	170
California	Benicia	38	500	140	35	650
California	Morro Bay	18	250	999	3	1
Oregon	Brookings	14	120	999	3	1
Oregon	Coos Bay	37	300	999	16	1000
Oregon	Umpqua	22	200	999	13	1
Oregon	Newport	30	300	135	5	40
Oregon	Toledo	10	150	135	16	1
Oregon	Garibaldi	18	200	999	6	18
Oregon	Astoria	43	600	999	15	20
Oregon	St. Helens	43	600	197	98	1500
Oregon	Portland	43	600	197	103	893
Washington	Vancouver	43	500	197	103	650
Washington	Woodland	43	600	197	84	200
Washington	Kalama	43	600	197	73	1000
Washington	Longview	43	600	197	66	800
Washington	Grays Harbor	36	350	999	16	250
Washington	Port Angeles	39	999	999	73	85
Washington	Anacortes	36	999	999	113	27
Washington	Everett	40	999	999	125	56
Washington	Seattle	50	700	999	148	600
Washington	Tacoma	48	330	999	173	820
Washington	Olympia	30	350	179	203	66
Washington	Bellingham	32	999	999	133	35
Hawaii	Honolulu	40	500	999	3	200
Hawaii	Barbers Point	38	400	999	3	80
Hawaii	Kahului	35	400	999	3	21
Hawaii	Nawiliwili	36	600	999	3	21
Hawaii	Port Allen	35	500	999	3	1

STATE	PORT	Access Interstate	Access Highway	Access State Route	Rail Class Access	Metropolitan Area Skilled Labor Workforce Population
California	San Diego	I	-	SR	1	High
California	Los Angeles	I	H	SR	1	High
California	Long Beach	I	H	SR	1	High
California	Hueneme	-	-	SR	3	High
California	Oakland	I	-	-	1	High
California	Richmond	I	H	-	1	High
California	San Francisco	I	H	SR	3	High
California	Humboldt Bay	-	H	SR	-	Medium
California	Benicia	I	H	SR	1	High
California	Morro Bay	-	-	SR	-	Low
Oregon	Brookings	-	H	-	-	Low
Oregon	Coos Bay	-	H	-	3	Medium
Oregon	Umpqua	-	H	-	-	Low
Oregon	Newport	-	H	-	-	Low
Oregon	Toledo	-	-	SR	-	Low
Oregon	Garibaldi	-	H	-	-	Low
Oregon	Astoria	-	H	SR	3	Medium
Oregon	St. Helens	-	H	-	-	Medium
Oregon	Portland	I	-	-	1	High
Washington	Vancouver	I	-	-	1	High
Washington	Woodland	I	-	-	1	Medium
Washington	Kalama	I	-	-	1	Medium
Washington	Longview	I	-	-	1	Medium
Washington	Grays Harbor	I	-	-	1	Medium
Washington	Port Angeles	-	H	SR	-	Medium
Washington	Anacortes	-	-	SR	-	Medium
Washington	Everett	I	-	-	1	High
Washington	Seattle	I	-	-	1	High
Washington	Tacoma	I	-	-	1	High
Washington	Olympia	I	-	-	1	High
Washington	Bellingham	I	-	-	1	Medium
Hawaii	Honolulu	-	-	-	-	High
Hawaii	Barbers Point	-	-	-	-	High
Hawaii	Kahului	-	-	-	-	Low
Hawaii	Nawiliwili	-	-	-	-	Low
Hawaii	Port Allen	-	-	-	-	Low

STATE	PORT	Approximate Crane Capacity (tons)	Dry Dock	Dry Dock Width (ft.)	Dry Dock Length (ft.)	Presently Accommodates 500 ft. LOA Vessel
California	San Diego	650	YES	174	1000	YES
California	Los Angeles	45	NO	-	-	YES
California	Long Beach	40	NO	-	-	YES
California	Hueneme	136	NO	-	-	YES
California	Oakland	-	YES	75	390	YES
California	Richmond	55	YES	100	750	YES
California	San Francisco	60	YES			YES
California	Humboldt Bay	2	NO	-	-	YES
California	Benicia	-	NO	-	-	YES
California	Morro Bay	-	NO	-	-	NO
Oregon	Brookings	-	NO	-	-	NO
Oregon	Coos Bay	-	NO	-	-	YES
Oregon	Umpqua	1	NO	-	-	NO
Oregon	Newport	30	NO	-	-	NO
Oregon	Toledo	-	NO	-	-	NO
Oregon	Garibaldi	-	NO	-	-	NO
Oregon	Astoria	-	NO	-	-	YES
Oregon	St. Helens	-	NO	-	-	NO
Oregon	Portland	600	YES	186	960	YES
Washington	Vancouver	230	YES	-	-	YES
Washington	Woodland	-	NO	-	-	NO
Washington	Kalama	-	NO	-	-	YES
Washington	Longview	114	NO	-	-	YES
Washington	Grays Harbor	-	YES	-	-	YES
Washington	Port Angeles	200	NO	-	-	YES
Washington	Anacortes	260	YES	90	314	YES
Washington	Everett	150	NO	-	-	YES
Washington	Seattle	155	YES	93	552	YES
Washington	Tacoma	155	NO	-	-	YES
Washington	Olympia	155	NO	-	-	YES
Washington	Bellingham	140	YES	130	470	YES
Hawaii	Honolulu	250	YES	150	1000	YES
Hawaii	Barbers Point	-	NO	-	-	YES
Hawaii	Kahului	-	NO	-	-	YES
Hawaii	Nawiliwili	-	NO	-	-	YES
Hawaii	Port Allen	-	NO	-	-	YES

Appendix C. Preliminary Port Navigation Access and Infrastructure Databases used for Pre-Screen Analysis

Preliminary Port Navigation Access Database (Superseded by Appendix B)

Port (State)	Nav. Depth Limit (Ft)	Nav. Width Limit (Ft)	Air Draft Limit (Ft)	Proximity to Open Ocean (nmi)
California				
San Diego	42	600	-	<1
Los Angeles	53	1,050	-	<1
Long Beach	76	1,050	-	<1
Hueneme	35	333	-	<1
Morro Bay	~18	~250	-	<1
Oakland	50	600	220	11
Richmond	38	200	220	13
Stockton	35	250	135	90
San Francisco	38	600	190	9
West Sacramento	30	200	138	90
Redwood City	30	300	135	29
Benicia	38	200	140	32
Humboldt Bay	38	400	-	0
Oregon				
Brookings	14	170	-	<1
Gold Beach	13	300	-	<1
Port Orford	12	100	-	<1
Bandon	16	150	-	<1
Coos Bay	37	300	-	13
North Bend	37	300	-	6
Umpqua	22	200	-	10
Siuslaw	16	200	-	4
Newport	30	300	135	2
Toledo	10	150	135	13
Tillamook Bay	18	200	-	<1
Garibaldi	10	100	-	3
Nehalem	8	300	28	12
Astoria	43	600	197	12
St Helens	43	600	197	95
Portland	43	600	197	100
Washington				
Vancouver	43	600	197	100

Port (State)	Nav. Depth Limit (Ft)	Nav. Width Limit (Ft)	Air Draft Limit (Ft)	Proximity to Open Ocean (nmi)
Woodland	43	600	197	81
Kalama	43	600	197	70
Longview	43	600	197	63
Ilwaco	17	150	-	7
Grays Harbor	36	350	-	13
Port Angeles	39	n/a	-	70
Anacortes	36	n/a	-	110
Everett	40	n/a	-	122
Seattle	50	700	-	140
Tacoma	48	330	-	165
Olympia	30	350	179	200
Hawaii			-	
Honolulu	40	500	-	<1
Barbers Point	38	400	-	<1
Kewalo	20	~200	-	<1
Kahului	35	660	-	<1
Kawaihae	35	500	-	<1
Nawiliwili	36	600	-	<1
Port Allen	35	500	-	<1

Preliminary Port Facility Infrastructure Access Database (Superseded by Appendix B)

Port (State)	Berth Length (ft.)	Preliminary Upland Area Estimate (Acres)	Road Access	Rail Access	Dry Dock Facility	Cursory Manufacturing and Workforce Rating
California						
San Diego	1502	1	I, SR	1	Yes	High
Los Angeles	2100	24	I, H, SR	1	-	High
Long Beach	3000	100	I, H, SR	1	-	High
Hueneme	1000	130	H, SR	3	-	High
Morro Bay	400	0	SR	-	-	Low
Oakland	3129	166	I	1	-	High
Richmond	1620	130	I, H	1	-	High
Stockton	2400	76	I, H, SR	3	Yes	High

Port (State)	Berth Length (ft.)	Preliminary Upland Area Estimate (Acres)	Road Access	Rail Access	Dry Dock Facility	Cursory Manufacturing and Workforce Rating
San Francisco	1200	0	I, H, SR	1	-	High
West Sacramento	855	0	I, H, SR	1	-	High
Redwood City	3129	166	I	1	-	High
Benicia	2400	4000 (car storage)	I, H, SR	1	-	High
Humboldt Bay	1136	60	H, SR	0	-	Medium
Oregon			-			
Brookings	130	0	SR	0	-	Low
Gold Beach	100	0	SR	0	-	Low
Port Orford	300	0	SR	0	-	Low
Bandon	No Berth	0	SR	0	-	Low
Coos Bay	500	20	SR	3	-	Medium
North Bend	500	-	SR	3	-	Medium
Umpqua	330	0	SR	-	-	Low
Siuslaw	No Berth	0	SR	-	-	Low
Newport	620	10	SR	-	-	Low
Toledo	No Berth	0	SR	-	-	Low
Tillamook Bay	No Berth	0	0	-	-	Low
Garibaldi	120	0	0	-	-	Low
Nehalem	No Berth	0	0	-	-	Low
Astoria	1300	13	H, SR	3	-	Medium
St Helens	300	0	0	-	-	Medium
Portland	780	53	I	1	Yes	High
Washington						
Vancouver	1250	65	I	1	-	1250
Woodland	1250	30.5	I	1	Yes	1250
Kalama	0	200	I	-	-	0
Longview	1088	0	I	1	-	1088
Ilwaco	850	0	I	1	-	850

Port (State)	Berth Length (ft.)	Preliminary Upland Area Estimate (Acres)	Road Access	Rail Access	Dry Dock Facility	Cursory Manufacturing and Workforce Rating
Grays Harbor	150	0	0	-	-	150
Port Angeles	1400	120	I	1	-	1400
Anacortes	950	0	H, SR	-	-	950
Everett	570	0	SR	-	Yes	570
Seattle	650	13	I	1	Yes	650
Tacoma	350	0	I	1	Yes	350
Olympia	1200	25	I	1	-	1200
Hawaii			-			
Honolulu	1850	8.9	I	-	Yes	High
Barbers Point	250	4.9	0	-	-	High
Kewalo	-	0	0	-	-	Low
Kahului	1658	15.9	0	-	-	Low
Kawaihae	1150	30.6	0	-	-	Low
Nawiliwili	704	20.5	0	-	-	Low
Port Allen	1200	0.7	0	-	-	Low

Appendix D. Vessel Applicability Cursory Availability Assessment

The vessels have been assessed relative to the applicability to offshore floating wind (OFW) and marine hydrokinetic (MHK) developments within this study. Additionally, a cursory assessment of the availability of the vessels in the project areas and across the U.S. has been conducted. A refined availability assessment relative to OFW and MHK needs is provided in Chapter 5. Ratings follow the key table shown below.

Vessel Applicability and Availability Analysis Key

	Low	Medium	High
Applicability	The functions and capabilities provided by this vessel may not be required for OFW and MHK development	The functions and capabilities provided by this vessel may be required for OFW and MHK development	The functions and capabilities provided by this vessel are very likely to be required for OFW and MHK development
Preliminary Availability	Mobilization from outside the U.S. may be required. May be subject to Jones Act.	May be available in project area, but mobilization from elsewhere in U.S. may be required	Typically available in project study area or elsewhere in the U.S.

Fixed Foundation Vessel Summary

Vessel	Activity	Applicability	Preliminary Availability
Cable Laying Vessel	Shore and Array Cable Install	High	Medium, specialized use
Cable Laying Barge	Shore and Array Cable Install	Medium, depending on sea state	Medium, specialized use
Assist Tug	Barge and Device Transport	High	High
Ocean Class Tug	Barge and Device Transport	High	Medium. May be mobilized from elsewhere in U.S.
Anchor Handling Tug (~125 ton bollard)	Anchor and Mooring Deployment	High	Medium. May be mobilized from elsewhere in U.S.
Anchor Handling Tug (>250 ton bollard)	Anchor and Mooring Deployment	Medium, may be oversized	Medium. May be mobilized from elsewhere in U.S.
Multi-Purpose Vessel	ROV support and Anchoring, Mooring	High	Medium. Special use available.
Jack Up Barge	Assembly, installation	Low, intermediary assembly only	Medium May be mobilized from elsewhere in U.S.
Jack Up Vessel (>500 ton crane)	Assembly, installation	Low, intermediary assembly only	Low. Europe Only. Jones Act exception Required at present.
Floating Crane	Assembly, installation	Medium, intermediary assembly (Spar, MHK)	Medium. May be mobilized from elsewhere in U.S.
Floating Crane	Substructure and Substation Installation	Low, may be oversized. (Spar)	Low. Highly specialized Use

(1000+ tons)			
Bulk Carrier	Blade and turbine component transport	High	Medium
Barge	Blade and turbine component transport	High	High
CTV	O&M access	High, OFW only	Low. New vessel fabrication may be required.

OFW/MHK Demonstration Project Vessel Summary

Vessel	Activity	Applicability	Preliminary Availability
Anchor Handling Tug	Anchor and Mooring Deployment, Device towing	High	Medium. May be mobilized from elsewhere in U.S
Multi-Purpose Vessel	Lead Tug, Cargo Transport, Geotechnical investigation, Anchor and Mooring Deployment	High	Medium. Special use available.
Assist Tug	Assist Tug, Lead Tug	High	High
Ocean Support Tug	Device towing	High	High
Floating Crane	Assembly, installation	High	Medium. May be mobilized from elsewhere in U.S.
Multicat Tug	Assembly, installation, device tow, anchor deployment	High	Low. Fleet typically flagged as European
Research Vessel	Benthic and Marine Mammal Survey	High	High

Oil and Gas Floating Production Unit Installation Vessel Summary

Vessel	Activity	Applicability	Preliminary Availability
Anchor Handling Tug	Lead tug	High	Medium. May be mobilized from elsewhere in U.S
Assist Tug	Assist tug	High	High
Ocean Tug (150 ton Bollard)	Dual lead tugs	High	High
Multi-Purpose Vessel	Geotechnical, subsea inspection, ROV support	High	Medium. Special use available.
Cable Laying Vessel	Shore and Array Cable Install	High	Medium. May be mobilized from elsewhere in U.S.
Floating Crane	Rig Platform Installation	Medium. intermediary assembly (Spar)	Medium. May be mobilized from elsewhere in U.S
Floating Crane (1000+ tons)	Rig Platform Installation	Medium. Potential substation assembly	Low. Highly specialized Use

Appendix E. Vessel Fleet

Appendix E contains photographs of the potential vessel required for OFW and MHK development. Not all vessels may be required as certain vessels can provide several services. Exact vessel fleet will be dependent on developer technology, vessel availability, economics, timeline requirements, location, proximity to port, and metocean conditions. The table below lists the vessel types which are shown in this appendix.

Vessel List

Vessel	Picture #
Survey Vessel	1
Research Vessel	2
Cable Laying Vessel	3
Cable Laying Barge	4
Offshore Service Vessel	5
Multi-Purpose Vessel	6
Bulk Carrier	7
ABS Certified Deck Barge	8
Ocean Tug	9
Support Tug	10
Multicat Tug	11
Anchor Handling Tug	12
O&M Mothership	13
Workboat or Offshore Supply Vessel	14
Crane Barge (100-500 ton)	15
Crane Barge (700-1000 ton)	16
Crane Barge (1000+ ton)	17
Jack-Up Vessel	18



Survey Vessel 1 - 54' Diesel Catamaran Survey Boat – Armstrong Marine
[<http://armstrongmarine.com/i-16235949-54-diesel-catamaran-survey-boat.html>]



Research Vessel 2 - Benthic Habitat Survey – R/V Oceanus
[<https://www.whoi.edu/page.do?pid=8158>]



Cable Laying Vessel 3 - C.S Sovereign
[https://www.fleetmon.com/vessels/cs-sovereign_891829_44595/photos/79169/]



Cable Laying Barge 4 - CB Networker
[<http://www.cablesm.fr/CB%20Networker.pdf>]



Offshore Supply Vessel 5 – 130719-VA

[<http://www.workboatbrokers.com/product/1356/130719-va>]



Multi-Purpose Vessel 6 - Fugro Symphony [<http://www.fugro.com/docs/default-source/Expertise-docs/Our-World/Vessels/fugro-symphony.pdf?sfvrsn=4>]



Bulk Carrier 7 - BBC Maine

[<http://www.boatnerd.com/news/newsthumbs/images-08-4/8-BBC-Maine-11-07-08-jm.jpg>]



ABS Certified Deck Barge 8 - Gray Barge Company – Gwendolyn

[<http://www.graybarge.com/abs-offshore-ocean-barges/gwendolyn>]



Ocean Tug 9 - Crowley Ocean Wind
[<http://www.crowley.com/ocean>]



Support Tug 10 - Garth Foss
[<https://www.flickr.com/photos/-jon/8576779172/>]



Multicat Tug 11 - Delta Marine Voe Viking
[http://www.maritimejournal.com/news101/industry-news/voe_jarl_ready_to_catch_the_wind]



Anchor Handling Tug 12 - Tor Viking II
[<http://gcaptain.com/2015/09/04/ship-photos-of-the-day-shells-arctic-fleet/#.Vpf6tPkrJhE>]



O&M Mothership 13 - IMT9180 Windfarm Mothership

[<http://www.offshoreshipdesigners.com/offshore-vessel-design/renewable-energy-support-vessels/imt9180-windfarm-mothership/>]



Offshore Service Vessel 14 – Havyard 832 SOV

[<http://www.offshorewind.biz/2015/02/13/havyard-delivers-wind-farm-service-vessel-to-esvagt/>]



Crane Barge (100-500 ton) 15 Weeks 532

[<http://www.weeksmarine.com/equipment/equipment-details/weeks---532>]



Crane Barge (700-1000 ton) 16 Manson Crane

[<http://www.liftech.net/all-galleries/wharf-galleries/cemex-wharf-gallery/>]



Crane Barge (1000+ ton) 17 Floating Crane E.P Paup
[<http://www.mansonconstruction.com/ep-paup/>]



Jack-Up Vessel – 18 Fred Olsen Wind Carrier Brave Tern
[http://fredolsen-energy.com/brave-tern?WAF_IsPreview=true]

Appendix F. Road and Rail Transport Evaluation Criteria

- Rail Transport
 - Classification
- Class 1 Mainline port connection
 - Typically, 143 tons, up to 400 tons with modifications
 - May apply to exceed in some cases
- Shortline Rail
 - Limits vary
 - Geometric limitations
- Class 1 Rail
 - Double stack containers
 - Segments vary due to tunnel and bridge limitations
 - Height (typically ~20.5 ft.)
 - Width (typically ~13 ft.
 - Length (typically 43-45 m)
- Secondary Shortline
 - Clearances: ~17 ft. height, 10.6 ft. wide (Typical, Oregon)
- Road Transport
 - Classifications
- State Highways
- Rural Roads
 - Oversize Load Regulations
- Dimensional cargo limits (Oregon)
 - ~14 ft. wide on two lane highways
 - ~17 ft. height
 - ~150 ft. length
- Weight limits
 - ~98,000 lbs
- Pilot car requirements
 - Loads exceeding 12 ft. wide on two-lane highways must use a front pilot vehicle.
 - Carriers with Single Trip Over-Dimension Permits for loads over 14 ft. 6 inches high must either use a pilot car escort with an over-height pole in front of the high load throughout the trip or sign a waiver that carrier liable for damage (Oregon)
- State-variable regulations
 - Geometric limitations
- Bridge and tunnel clearances

Appendix G. Vessel Navigation and Berthing Analysis

Minimum geometry (for ideal conditions) is based on a U.S. Army Corps of Engineers (USACE) report, Deep-Draft Coastal Navigation Entrance Channel Practice which states, “For one-way ship traffic, values for channel width vary from 2 to 7 times the design ship beam.” (USACE 1999). USACE document EM 1110-2-1613 states a value (navigation channel width) of 2.5 times the design ship beam for canals with negligible currents should be conservative (USACE 2006). Therefore, an approximate lower bound of potential navigation channel width requirements is assumed to be 2x vessel (or device) beam (herein referred to as “ideal”), for 1-way traffic for channels with negligible currents. Requirements for 2-way vessel traffic result in wider navigation channel widths.

The Permanent International Association of Navigation Congresses (PIANC) guidelines were used to develop a range of navigation channel design geometry for each vessel in favorable and un-favorable conditions, which are more conservative than the 2x beam assumption listed above. PIANC is generally used as a guideline when designing new navigation channels, but does not necessarily indicate existing navigation channels are unsafe should they not meet geometry recommended by PIANC. Favorable environmental conditions for protected water navigation and vessel characteristics have been considered to provide a value of the estimated horizontal geometry margin for the waterway to support the fleet of vessels. The higher value of the margin includes unfavorable conditions that assess higher environmental conditions values and vessel speeds that generate a more conservative geometry requirement.

Assumptions utilized to estimate favorable and un-favorable conditions using PIANC guidelines are shown below.

PIANC analysis assumptions.

Conditions	Favorable Conditions	Unfavorable Conditions
Ship Maneuverability	"Good"	"Moderate"
Vessel Speed	Slow [5 kts ≤ v < 8 kts]	Moderate [8 kts ≤ v < 12 kts]
Cross Winds	Mild [v < 15 kts]	Moderate [15 kts ≤ v < 33 kts]
Cross-current	Low [0.2 kts ≤ v < 0.5 kts]	Moderate [0.5 kts ≤ v < 1.5 kts]
Longitudinal current	Low [v < 1.5 kts]	Moderate [1.5 kts ≤ v < 3 kts]
Wave Heights	<1 m	<1 m
Aids to Navigation (AtoN)	"Excellent"	"Moderate"
Depth of waterway > 1.15 (draft)	1.5 T > h ≥ 1.15 T - Considered [Ideal ≥ 1.5 T]	1.5 T > h ≥ 1.15 T - Considered [Non-ideal h < 1.15 T]

*T = vessel draft

A more detailed design phase is required to validate, develop, and refine the conceptual-level geometry estimated in this assessment. Positive developments regarding horizontal dimensions and reduction of the risk of accidents are the improvements to the navigation channel depths, restricted vessel operations, and the latest navigation technology such as differential global positioning systems and Vessel Traffic Services, and Automatic Identification Systems. All these aspects and technologies provide enhanced knowledge of vessel location; early drift detection, nearby traffic and fairway environment, and vessel controlled operations, which may result in affordable reductions in the horizontal geometry estimated herein.

Summary of conceptual navigation channel requirements for potential vessel fleet

Vessel Particulars					Nav. Channel Depth (Ft)	Navigation Channel Width (ft)			Classification		
Vessel	Activity		LOA (ft)	Beam (ft)	Draft (ft)	PIANC: Conceptual-level	PIANC Favorable	PIANC Un-Favorable	USACE Ideal	Technology	Port
Survey Vessel	Marine Surveying	Small	50	24	7	10	65	101	48	OFW, MHK	QR or AP
		Large	231	42	14.3	18	114	177	84	-	-
Research Vessel	Marine Habitat Survey	Small	54	16	5	7	44	68	32	OFW, MHK	QR or AP
		Large	177	33	17.5	21	90	139	66	-	-
Cable-Laying Vessel	Cable Laying	Small	305	60	21	25	162	252	120	OFW, MHK	AP
		Large	425	75	33	39	203	315	150	-	-
Bulk Carrier	Blade transport	Small	330	66	21	25	179	278	132	OFW, MHK	IEP, AP
		Large	470	75	32	38	203	315	150	-	-
Deck Barge	Blade transport	Small	300	90	16	20	261	378	180	OFW, MHK	IEP, AP
		Large	343	76	18	22	221	320	152	-	-
Ocean Tug	Assembled Device Transport		145	50	18	22	135	210	100	OFW	AP
Anchor Handling Tug	Assembled Device Transport	Small	200	45	15	19	122	189	90	OFW, MHK	AP
		Large	360	80	26	31	216	336	160	-	-
Multi-Purpose Vessel/Offshore Construction	Assembled Device Transport, Mooring Geotech, Survey	Small	200	50	18	22	135	210	100	OFW, MHK	IEP, AP
		Large	425	80	25	30	216	336	160	-	-
Support Tug	Assembled Device Transport		105	40	16	20	108	168	80	OFW, MHK	IEP, AP
Crane Barge (700-1000 ton)	Turbine Assembly		380	105	10	13	284	441	210	OFW	AP
Crane Barge (~100-500 tons)	MHK installation	Small	100	40	5	7	108	168	80	MHK	AP
		Large	200	70	10	13	189	294	140	-	-
Multicat Tug	Device Install/Maintenance		85	38	8	11	103	160	76	MHK	IEP, AP
Crew Transfer Vessel (CTV)	Operations and Maintenance		65	22	7	10	60	93	44	OFW	QR

Devices of interest to this study (offshore floating wind [OFW], marine hydrokinetic [MHK]) were evaluated to estimate conceptual level navigation requirements, similar to the potential vessel fleet. In some cases the MHK devices may be transported via barge; however, the navigation requirements should they be towed in water are presented.

Device navigation channel parameters

Vessel Particulars					Nav. Channel Depth (Ft)	Navigation Channel Width (ft)			
Device	Technology	Draft (ft)	Beam (ft)	Air Draft (ft)	PIANC: Conceptual	PIANC Favorable	PIANC Un-Favorable	USACE Ideal	Port
Semi-Sub	OFW	33	230	656	39	621	874	460	AP
		23	164	35	28	443	624	328	IEP, AP
Spar	OFW	263	27	656	296	73	103	54	AP
		20	27	20	24	73	103	54	IEP, AP
TLP	OFW	33	230	656	39	621	874	460	AP
		27	164	35	32	443	624	328	IEP, AP
Floating Point-Absorber	MHK	33	66	NA	39	179	251	132	IEP, AP
		17	66	NA	21	179	251	132	IEP, AP
Attenuator	MHK	10	14	NA	13	38	54	28	IEP, AP
		7	14	NA	10	38	54	28	IEP, AP
Wave Surge Converter	MHK	40	82	NA	39	222	312	164	IEP, AP
Floating Oscillating Water Column	MHK	43	164	NA	50	443	624	328	AP

Vessel and Device Berthing Analysis

Based on an assessment of the vessel fleet that may be required to support these industries, conceptual-level port infrastructure requirements were estimated. The assessment is based on national (USACE 2006) and international standards (American Bureau of Shipping [ABS] 2014, PIANC 2002) and the potential vessel fleet outlined in Technical Memorandum #3, Assessment of Vessel Requirements. A more detailed design phase is required to assess the adequacy of the facility, which considers specific metocean conditions to the location of the facility, and may result in less conservative requirements. Furthermore, it is assumed that should a port state the capability to support a certain length vessel, that the port facilities meet standards.

OFW foundations, and some MHK devices, have significant beam, and berthing width requirements, greater than most of the support vessels that will be using the ports. If berthed quayside at an Assembly Port, Construction Port, or Cluster Port, the device should have a clearance from the edge of the nearby navigation channel (and passing vessels) that meets local USACE requirements. The specific offset distance may vary by restriction, but based on initial review the required offset distance is approximately 100 ft.

General requirements for shore parallel berths include the clearance between vessels at berth, width of dredged tidal berth, and the length of the dredged area. The dredged width of the berth should allow for approximately 1.50 times the beam of the vessel and 1.25 times Length Overall (LOA) for the length of the dredged area when tug assisted. Guidelines for the conceptual-level assessment recommend that the diameter of the turning basin, if the vessels are required to perform such maneuvers, should allow for a minimum clearance of approximately 1.60 times the LOA of the largest vessel. For areas with low currents this value may be reduced to 1.2 LOA (USACE 2006)

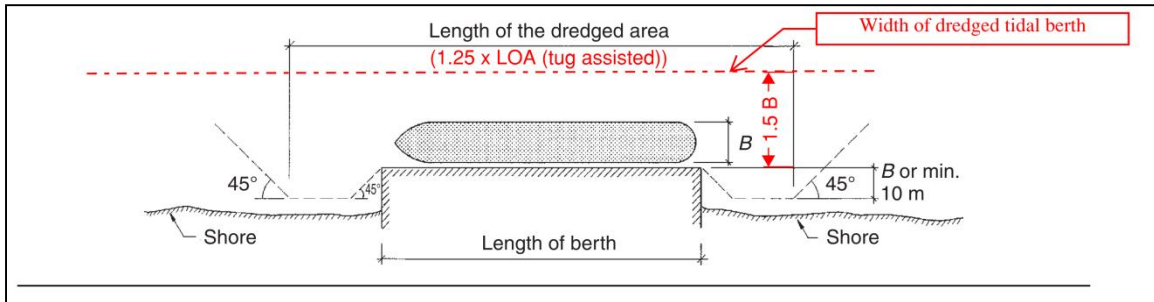

Example of conceptual-level berthing analysis.

Conceptual-level minimum berth characteristics

Vessel Particulars					Berth Characteristics (Marginal Berth)				Classification		
Vessel	Activity		LOA (ft)	Beam (ft)	Draft (ft)	Depth (ft.)	Width (ft.)	Length (ft.)	Turning Basin Diameter (ft.)	Technology	Port
Survey Vessel	Marine Surveying	Small	50	24	7	9	36	63	80	OFW, MHK	QR or AP
		Large	231	42	14.3	17	63	289	370	-	-
Research Vessel	Marine Habitat Survey	Small	54	16	5	6	24	68	87	OFW, MHK	QR or AP
		Large	177	33	17.5	21	50	222	284	-	-
Cable-Laying Vessel	Cable Laying	Small	305	60	21	25	90	382	488	OFW, MHK	AP
		Large	425	75	33	38	113	532	680	-	-
Bulk Carrier	Blade transport	Small	330	66	21	25	99	413	528	OFW, MHK	IEP, AP
		Large	470	75	32	37	113	588	752	-	-
Deck Barge	Blade transport	Small	300	90	16	19	135	375	480	OFW, MHK	IEP, AP
		Large	343	76	18	21	114	429	549	-	-
Ocean Tug	Assembled Device Transport		145	50	18	21	75	182	232	OFW	AP
Anchor Handling Tug	Assembled Device Transport	Small	200	45	15	18	68	250	320	OFW, MHK	AP
		Large	360	80	26	30	120	450	576	-	-
Multi-Purpose Vessel/Offshore Construction	Assembled Device Transport, Mooring Geotech, Survey	Small	200	50	18	21	75	250	320	OFW, MHK	IEP, AP
		Large	425	80	25	29	120	532	680	-	-
Support Tug	Assembled Device Transport		105	40	16	19	60	132	168	OFW, MHK	IEP, AP
Crane Barge (700-1000 ton)	Turbine Assembly		380	105	10	12	158	475	608	OFW	AP
Crane Barge (~100-500 tons)	MHK installation	Small	100	40	5	6	60	125	160	MHK	AP
		Large	200	70	10	12	105	250	320	-	-
Multicat Tug	Device Assembly		85	38	8	10	57	107	136	MHK	IEP, AP
Crew Transfer Vessel (CTV)	Operations and Maintenance		65	22	7	9	33	82	104	OFW	QR
O&M Mothership	Operations and Maintenance for	Small	400	90	20	23	135	500	640	OFW	AP or QR
		Large	600	130	25	29	195	750	960		

Appendix H. Offshore Wind and Marine Hydrokinetic Port Facility Literature Review Notes

Maryland Study (Kinetic Partners 2011).

Topic		
Crane	<ul style="list-style-type: none"> • 1000 ton on tracks from vessel to storage (ideal) 	<ul style="list-style-type: none"> • 1000 ton recommended requirement
Area	<ul style="list-style-type: none"> • 200 acres for assembly and storage (ideal) • 112-150 acres (US East coast) • 50-75 acres of dock, plus 100-150 acres for assembly, storage, inventory 	<ul style="list-style-type: none"> • Bremerhaven has 62 acre dock and 450 acre supplier park (multiple developers, cluster, up to 160 turbines per year) • 60 acres dockside, 30 acres adjacent, 100 acres for other operations • Dockside width of 98 ft. for crawler cranes
Depth	<ul style="list-style-type: none"> • 24 ft. (Europe) 	<ul style="list-style-type: none"> • 24 ft. (Recommended)
Berth	<ul style="list-style-type: none"> • 2 berths, 450 length each (Europe) • 450' min length (5 MW) 	<ul style="list-style-type: none"> • Should be parallel to port area. Finger piers would need to be at least 100 ft. wide and accommodate 2,000 psf • Separate 80 ft. berth
Air Draft	<ul style="list-style-type: none"> • Could exceed 650 ft. 	
Other necessary equipment	<ul style="list-style-type: none"> • Large crawler cranes • Medium crawler cranes • Truck mounted cranes • Cherry pickers 	<ul style="list-style-type: none"> • Forklifts • Transport vehicles • Trailers • Low loaders
Dock Load Bearing	<ul style="list-style-type: none"> • May exceed 2,000 psf 	
Offshore substation	<ul style="list-style-type: none"> • May exceed 1300 MT 	
Prototype:	<ul style="list-style-type: none"> • BREMERHAVEN PORT • Capacity up to 160 turbines per year • 10 acres for staging immediate loading • 27 acres for assembly 	<ul style="list-style-type: none"> • 2000 psf dock load • Crawler cranes up 100' turning radius • Transportation needs: 17 acres
Vessels	<ul style="list-style-type: none"> • Turbine import/delivery: large open-hatch cargo vessel: 470 ft. LOA, 75 ft. Beam, 32 ft. draft 	
Overland Transport	<ul style="list-style-type: none"> • Not discussed 	

New Jersey Study (Yahalom *et al.* 2014)

Topic	
Crane	<ul style="list-style-type: none">• 750-1000 tons
Area	<ul style="list-style-type: none">• 100 acres open storage yard area plus additional storage area (typical)
Depth	<ul style="list-style-type: none">• 28 channel depth (Recommended)• Horizontal clearance: 400 ft.
Berth	<ul style="list-style-type: none">• 35 ft depth (typical)• 1260 ft. Length (typical)• 580 ft. Width (typical)• Protected Harbor• 720 ft. (2-3 vessel lengths)• 22 ft. berth depth (Recommended)
Air Draft	<ul style="list-style-type: none">• None (typical)
Other necessary equipment	<ul style="list-style-type: none">• Ship repair services• Fuel, oil, other supplies needed
Dock Load Bearing	<ul style="list-style-type: none">• 1000 psf is not enough for Offshore wind
Offshore substation	<ul style="list-style-type: none">• N/A
Prototype:	<ul style="list-style-type: none">• N/A
Vessels	<ul style="list-style-type: none">•
Overland Transport	<ul style="list-style-type: none">• Road: Yes• Rail: Yes

Massachusetts Study (Tetra Tech 2010)

Topic		
Crane	<ul style="list-style-type: none"> Over 320 tons @ ~300 ft. 	<ul style="list-style-type: none"> Ideal crane is 1000 ton
Area	<ul style="list-style-type: none"> 10 acres minimum, maybe up to 17 acre minimum 15-15 acres desired To store 110 turbines would need 200 acres, but not all needed at one time. 	<ul style="list-style-type: none"> 9-12.5 acres for storage 1.5-2.5 acres for access, parking, offices Total site area 11-17.5 acres For approximately 20 turbines on site at one time, need 8.5 acres. 1.5-2.5 acres for assembly
Depth	<ul style="list-style-type: none"> Horizontal clearance: 130 ft. 	<ul style="list-style-type: none"> 24 ft. navigation channel depth
Berth	<ul style="list-style-type: none"> 24 ft. depth 450 ft. length 	<ul style="list-style-type: none"> 500 ft. – 1000 ft. quayside length
Air Draft	<ul style="list-style-type: none"> No restriction 	
Other necessary equipment	<ul style="list-style-type: none"> Shipyards availability for repair and specialized vessel construction? Large crawler crane, 2,500 mt as 250 mt at 10 m radius Medium crawler crane (600-800 tm) Truck mounted crane Cherry picker Forklift 	<ul style="list-style-type: none"> Triple axel trailer to move blades Self-propelled low loader for tower transport, 150-200 MT Terrain moving telescopic forklift (3 mt (3.5 ton) capacity) Terrain moving telescopic forklift with turntable Terrain moving transport vehicle
Dock Load Bearing	<ul style="list-style-type: none"> Need 2000 psf. May be mitigated with placement of load spreading slabs/mats 	<ul style="list-style-type: none"> 2000 psf not typically found on pile support structures Typical cargo wharves have capacity of 600 psf, with some up to 1000 psf.
Offshore substation	<ul style="list-style-type: none"> N/A 	
Prototype:	<ul style="list-style-type: none"> N/A 	
Vessels	<ul style="list-style-type: none"> Turbine import vessels: 330-470 ft. LOA, 66-75 ft. beam, 22-32 ft. draft Jackup barges (installation vessels): 300-450 ft. LOA, 100-130 ft. beam, 12-16 ft. draft. 	<ul style="list-style-type: none"> Barge transport of nacelle with blades: 150 ft. air draft, 450 ft. horizontal clearance. Deck capacity typical ocean barges is ~2,000 psf
Overland Transport	<ul style="list-style-type: none"> Rail limit is typically 90 tons, but up to 400 tons with bolster load. The bolster is the part of a railroad car body underneath that connects the truck's pivot to the body 	<ul style="list-style-type: none"> In general, most pieces can be transported by rail. First generation rail clearance is 19 ft.. Second generation generally 22.5 ft. ATR. Lines to ports may differ.

Virginia Study (BVG Associates 2015)

Topic	
Crane	<ul style="list-style-type: none">• N/A
Area	<ul style="list-style-type: none">• Tower manufacturing: 3 to 50 acres• Nacelle manufacturing: 15 to 25 acres• Blade manufacturing: 37 to 62 acres• Generator manufacturing: 15 to 19 acres• Foundation manufacturing and staging: 30 to 50 acres• Submarine cable: 20 to 22 acres• Substation construction: Specialty construction in existing shipyard• Construction Staging: 40-50 acres
Depth	<ul style="list-style-type: none">• 16 ft. depth (minimum)
Berth	<ul style="list-style-type: none">• 16 foot depth (minimum)• 420 ft. quay length
Air Draft	<ul style="list-style-type: none">• 65 ft.
Other necessary equipment	<ul style="list-style-type: none">• N/A
Dock Load Bearing	<ul style="list-style-type: none">• 1,000 – 4,000 psf
Offshore substation	<ul style="list-style-type: none">• N/A
Prototype:	<ul style="list-style-type: none">• N/A
Vessels	<ul style="list-style-type: none">• Jack-up vessel• General cargo vessel• Tug• Barge• Cable Lay Vessel• Offshore heavy-lift derrick
Overland Transport	<ul style="list-style-type: none">• N/A

DOE US PORT READINESS (GL Garrad Hassan 2014)

Topic	
Crane	<ul style="list-style-type: none"> • Spreader arms needed if single arm for blade lift. • Fabrication of nacelles may need up to a 75 ton crane • Trolley cranes can be used for transport on the berth.
Area	<ul style="list-style-type: none"> • Quayside storage area • Fabrication workshop length 80-95 m. • 200-270 m³ storage area for each nacelle • 500-700 m³ storage area for each blade • 340-430 m³ storage area for each tower
Depth	<ul style="list-style-type: none"> • The access channel width requirement should be qualified by stating that port access widths are customarily quoted as being the widest beam of two equally sized vessels which can pass through the narrowest part of the port approaches,
Berth	<ul style="list-style-type: none"> • N/A
Air Draft	<ul style="list-style-type: none"> • N/A
Other necessary equipment	<ul style="list-style-type: none"> • N/A
Dock Load Bearing	<ul style="list-style-type: none"> • Can assume SPMT used • 1500 – 2000 psf for nacelle, tower pieces, and substation • Common SPMT are 33 mt per axle. Commonly used in Europe to transport wind components, such as nacelle • 10-12 tons per axle, 2000 psf. • 15-20 axles per nacelle for SPMT
Offshore substation	<ul style="list-style-type: none"> • Approximate 6.5 tons per MW in the wind farm
Prototype:	<ul style="list-style-type: none"> • N/A
Vessels	<ul style="list-style-type: none"> • N/A
Overland Transport	<ul style="list-style-type: none"> • N/A

ORRECA Report (Bard and Thalemann n.d.)

Topic	
Crane	<ul style="list-style-type: none">• 1,000-1,5000 tons
Area	<ul style="list-style-type: none">• To handle 100 turbines per year (per BVG associates)• 20 acres for lay down and pre-assembly (construction port)• Additional 75 acres for sites with greater weather restrictions (construction port)• 1200 acres for manufacturing• ~10 acres for MHK• heavy lift capacity for MHK of 1000 tons• QRP port: 0.5 acre
Depth	<ul style="list-style-type: none">• 27 ft. draft
Berth	<ul style="list-style-type: none">• 700-1000 ft. quayside high capacity dock• Access to accommodate vessels, 450 foot LOA, 27 ft. draft, 150 ft. beam.• 500 m length at manufacturing ports• Quayside length of ~650 ft.• QRP port, 260 ft. min, 11.5 ft. draft
Air Draft	<ul style="list-style-type: none">• 300 ft. for vertical shipment of towers
Other necessary equipment	<ul style="list-style-type: none">• Office space
Dock Load Bearing	<ul style="list-style-type: none">• ~2,000 psf. Quick Reaction Ports ~1,00 psf
Offshore substation	<ul style="list-style-type: none">• N/A
Prototype:	<ul style="list-style-type: none">• N/A
Vessels	<ul style="list-style-type: none">• N/A
Overland Transport	<ul style="list-style-type: none">• N/A

Oregon MHK Report (Advanced Research Corporation 2009)

Topic	
Crane	<ul style="list-style-type: none"> • N/A
Area	<ul style="list-style-type: none"> • Dedicated land for assembly and deployment • Test center will only for short term basis (days or weeks). • Waterfront space needed for repair • Available areas for site assembly are limited in ports along the Oregon coast. In some cases land surrounding ports is privately owned. In other cases land is owned by the port, but may be allocated for different purposes. <ul style="list-style-type: none"> • Offshore developers moving the device from the land to the water can either be accomplished via crane from a strong dock or bulkhead or, in the case of large devices, via a marine railway. Very large devices will be built in a dry dock or on a custom barge that is also used to transport the device to the final site and deploy it.
Depth	<ul style="list-style-type: none"> • N/A
Berth	<ul style="list-style-type: none"> • N/A
Air Draft	<ul style="list-style-type: none"> • N/A
Other necessary equipment	<ul style="list-style-type: none"> • Local workforce. • Knowledgeable and adaptable • Developers have indicated staffing needs from no onsite personnel (autonomous operation) to 10 or more personnel available to support power monitoring and management <ul style="list-style-type: none"> • The typical assembly area will resemble a large building construction site. There will be a need for an office building, staging and storage of parts and equipment, utility hookups, and even covered work areas for some devices.
Dock Load Bearing	<ul style="list-style-type: none"> • Devices range from several tons to several thousand tons.
Offshore substation	<ul style="list-style-type: none"> • N/A
Prototype:	<ul style="list-style-type: none"> • In one sense, offshore devices are akin to medium scale ocean going vessels. <ul style="list-style-type: none"> • Devices range in diameter from 6 to 20 meters and in mass from 100 to 2,000 tons.
Vessels	<ul style="list-style-type: none"> • Demonstration: Standard barges, with coastal tugs • Coastal tugboat – to tow either the device or barge • Anchor handling tug – to deploy the anchors and mooring system • Cable deployment vessel – to install the power cable coming ashore and bury where necessary • Custom barge – designed to haul and deploy wave energy devices <ul style="list-style-type: none"> • Dive support vessel – to support divers to assemble and hook up the mooring system • Survey vessel – to map out and determine bottom composition and topography • Fred Devine Diving and Salvage Company operates a variety of equipment including their M/V Salvage Chief located in Astoria • No offshore deployment vessels with dynamic positioning are stationed along the Oregon coast.
Overland Transport	<ul style="list-style-type: none"> • Truck, rail • Developers designing devices for transport over truck or rail. If doesn't fit, will need barge. Final assembly may occur on barge.

Appendix I. Helipad Requirements

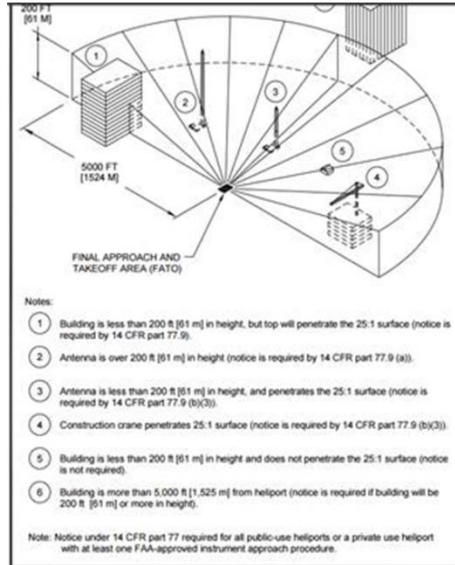
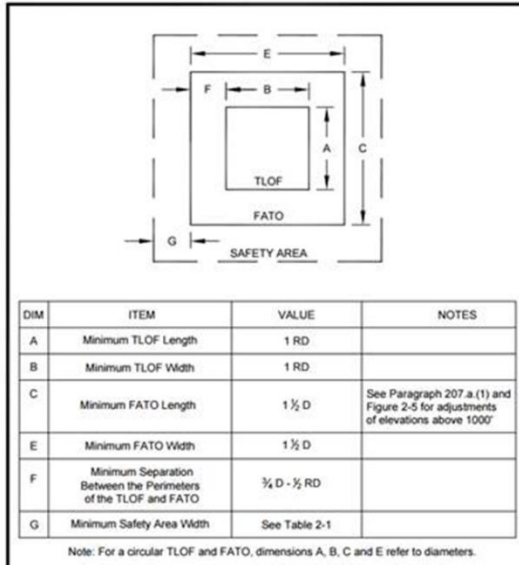

Helicopter landing pad geometric restrictions

Helipad geometry following USDOT heliport design for example OFW design helicopter

Helipad Parameter	Width
TLOF (A/B)	34 ft.
FATO (C/E)	60 ft.
Safety Area	84 ft.

Appendix J. – Floating Wind Projects, Including Demonstration-scale Projects

Project	Country	Operation since	Developer / Designer	Turbine Manufacturer	WTG	Design concept	Water depths
Blue H	Italy	2008 to 2009	Blue H	Blue H	1 x 80 kW	TLP	113 m
Hywind	Norway	2009	Statoil	Siemens	1 x SWT-2.3 MW	Spar	220 m
Poseidon P37	Denmark	2010 - 2013	Floating Power Plant	GAIA	3 x 11 kW	Semi-submersible	2 m
WindFloat	Portugal	2011	Principle Power	Vestas	1 x V80 – 2.0 MW	Semi-submersible	45 m
SeaTwirl P3	Sweden	2011	SeaTwirl	SeaTwirl	1 x P3 – 20 kW (vertical axis)	Spar	7 – 8 m
Keuka	USA	2011 - 2012	Keuka Energy	Keuka	5 x Keuka – 30 kW	Semi-submersible	2 m
GOTO FOWT 1	Japan	2012 - 2013	TODA/Kyoto University	Fuji	1 x Fuji 100 kW	Spar	91 m
SWAY Prototype	Norway	2012 - 2013	SWAY	Sway	1 x 15 kW	Spar	Not disclosed
Kyushu	Japan	2012	Kyushu University	Wind Lens	2 x Wind Lens 3 kW	Semi-submersible	3 m
GOTO FOWT 2	Japan	2013	TODA	Fuji Heavy Industry	1 x Subaru 80 – 2.0 MW	Spar	91 m
Fukushima	Japan	2013	Marubeni JV	Hitachi	1 x HTW 80 – 2.0 MW	Semi-submersible	120 – 125 m
DeepCwind	USA	2013 - 2014	DeepCWind Consortium	Renewegy	1 x VP – 20 kW	Semi-submersible	18 m
Spinwind 1	Norway	2014	Gwind	Spinwind	1 x 10 kW	Spar	16 m
SeaTwirl S1	Sweden	2015	SeaTwirl	SeaTwirl	1 x S1 – 30 kW (vertical axis)	Spar	31 m
SEM REV	France	2015	SEM REV	Not decided	Hub Platform	Semi-submersible	33 m
VertiWind	France	2015	Technip, EDF Consortium	VertiWind	1 x 2.6 MW	Semi-submersible	70 m

Project	Country	Operation since	Developer / Designer	Turbine Manufacturer	WTG	Design concept	Water depths
GICON - SOF	Germany	Planned, 2016	GICON	Siemens	1 x SWT - 2.3 MW	TLP	26 m
FloatGen	France	Planned, 2016	FloatGen	Gamesa	1 x G87 – 2 MW	Semi-submersible	30 m
Hywind Scotland	Scotland	Planned, 2017	Statoil	Siemens	5 x SWT – 6.0 MW	Spar	95 – 120 m
WindFloat Pacific	USA	Planned, 2017	Principle Power	Unknown	Unknown	Semi-submersible	Unknown
Kincardine	UK	Planned, 2018	KOWL	Servion (not confirmed)	6 to 8 MW (Not decided)	Semi-submersible	
Sea Reed - Groix	France	Planned	DCNS/Alstom	Alstom	1 x Haliade – 6.0 MW	Semi-submersible	Unknown
PelaStar Wave Hub	UK	Cancelled ¹	ETI/Glosten	Alstom	1 x Haliade – 6.0 MW	TLP	48 – 58 m
Dounreay	UK	Cancelled ²	Highlands and Islands Enterprise/DBD	Not decided	Up to 30 MW capacity	Tension Leg Platform	60 – 110 m

¹ Pelastar pulled out of the Wave Hub demonstrator due to an unresolved Ministry of Defence objection (the site falls within a MoD and NATS Safeguarding Zone) that reportedly prevented the developer from securing required investment

² The project was cancelled in December 2015. The reasons for cancellation are not yet clear.

Appendix K. Selected U.S. Fleet Location Snapshot

Vessel Name	Vessel Type	State	Flag	Deadweight (tons)
Coastal Navigator	Fire Fighting	AK	USA	2,364
Coastal Progress	Reefer	AK	USA	206
Coastal Trader	General Cargo	AK	USA	2,590
Sea Trader	General Cargo	AK	USA	1,496
Tanker 200	Replenishment	CA	USA	28,002
Melville	Research/Survey	CA	USA	1,597
Thomas G. Thompson	Research/Survey	CA	USA	-
Adele Elise	Offshore Supply	CA	USA	1,959
Sikuliaq	Research/Survey	CA	USA	1,556
Hos Dominator	Offshore Supply	CA	USA	2,102
Piper Inness	Crew Boat	CA	USA	-
Intl Freedom	Tug	CA	USA	-
Klihyam	Tug	CA	USA	-
Joseph Sause	Tug	CA	USA	-
Arthur Brusco	Tug	CA	USA	-
Rachel Carson	Offshore Supply	CA	USA	428
Drew Foss	Tug	CA	USA	-
Clean Ocean	Offshore Supply	CA	USA	750
Ocean Liberty	Offshore Supply	CA	USA	120
Edward Brusco	Tug	CA	USA	-
Sea Venture	General Cargo	CA	USA	5,654
Cape Mohican	Barge Carrier	CA	USA	39,027
Ocean Grand	General Cargo	CA	USA	19,436
Go Searcher	Offshore Supply	FL	USA	576
Walnut	Buoy-Laying	HI	USA	350
Nunui	Tug/Supply	HI	USA	-
Persistence Lab	Offshore Supply	HI	USA	508
Hawaii Responder	Pollution Control	HI	USA	1,258
Polar Ranger	Tug	HI	USA	-
Natoma	Tug	HI	USA	-
Henry Sr.	Tug	HI	USA	-
Hoku Kea	Tug	HI	USA	-
Mary Catherine	Tug	HI	USA	336
Niolo	Tug	HI	USA	-
Ocean Pathfinder	Tug	HI	USA	-
American Contender	Tug	HI	USA	-

Vessel Name	Vessel Type	State	Flag	Deadweight (tons)
Global Sentinel	Cable Layer	Int.	USA	8,527
Ocean Freedom	General Cargo	Int.	USA	14,359
Capt. Steven L. Bennett	Replenishment	Int.	USA	39,766
Coastal Venture	General Cargo	Int.	USA	1,383
Geysir	General Cargo	Int.	USA	2,000
Houston	General Cargo	Int.	USA	7,700
Norfolk	General Cargo	Int.	USA	17,478
Ocean Crescent	General Cargo	Int.	USA	8,097
Ocean Giant	General Cargo	Int.	USA	17,590
Seattle	General Cargo	Int.	USA	20,406
Transatlantic	Cargo/Container	Int.	USA	5,055
Miss Marilene Tide	Offshore Supply	LA	USA	6,100
Seacor Vanguard	Tug/Supply	LA	USA	3,314
Damon B Bankston	Offshore Supply	LA	USA	4,070
George Edward	General Cargo	LA	USA	-
Sea Service 1	General Cargo	LA	USA	-
Katherine Walker	Buoy-Laying	NY	USA	200
Yukon	Replenishment	OR	USA	27,955
Salishan	Tug	OR	USA	150
Ocean Globe	General Cargo	TX	USA	16,576
Aiviq	Multi-Purpose	WA	USA	4,129
Nanuq	Offshore Supply	WA	USA	4,363
Arrowhead	Offshore Supply	WA	USA	2,838
Ross Chouest	Tug/Supply	WA	USA	2,500
Montana	Tug	WA	USA	650
Silver Arrow	Offshore Supply	WA	USA	2,770
Hunter D	Tug	WA	USA	-
Pacific Titan	Tug/Supply	WA	USA	-
Commitment	Tug	WA	USA	798
Calvin	Tug	WA	USA	-
Discovery	Offshore Supply	WA	USA	1,422
Barbara Foss	Tug	WA	USA	-
Sidney Foss	Tug	WA	USA	-
John Glenn	General Cargo	WA	USA	77,021
Coastal Nomad	Reefer	WA	USA	2,881

Appendix L. Geodatabase Overview

L.1. Introduction

Information obtained from the study, *Determining the Infrastructure Needs to Support Offshore Floating Wind and Marine Hydrokinetic Facilities on the Pacific West Coast and Hawaii*, has been used to develop a geodatabase that will aid in the development of mitigation measures designed and initiated to minimize effects from offshore renewable energy activities. The geodatabase was developed to store spatial and non-spatial information associated with port infrastructure, to be queried along a port assessment criterion or any combination of criteria, to allow for simple data migration, and for editing capabilities.

The geodatabase may serve a number of functions such as standard mapping, web-mapping, and analysis. The geodatabase also provides both a spatial and non-spatial organized record of attribute data obtained during the study and built into the geodatabase. The geodatabase may also be utilized for:

- Customizing the display based on attribute data
- Providing a geodatabase that includes domains to preserve the attribute data accuracy for data obtained during the port assessment process
- Serving as a central data depository that can be utilized for future work

L.2. Layers and Attributes

The geodatabase contains three layers: 1) *Port Infrastructure*; 2) *Port Ratings*; and 3) *Regions with Gap Info*. Figure 1 depicts the skeleton of geodatabase.

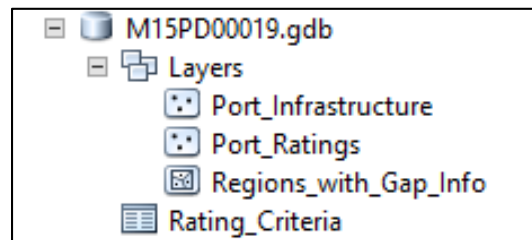

Figure 1. Geodatabase Skeleton Depiction

L.2.1. Port Infrastructure Layer

The *Port Infrastructure* layer of the geodatabase includes records for 36 individual ports with data for 18 attributes developed during the study. These include port facility infrastructure, navigation access, and supply chain criteria for different potential technologies and functions to support the industries, according to the classifications assigned in the pre-screening analysis of the study. The attribute data was collected between September 2015 and February 2016 and includes sources such as National Oceanic and Atmospheric Administration navigation charts, publically available port fact sheets, aerial and satellite imagery (e.g., Google Earth), available port facilities documents and strategic plans, communication with ports, and state transportation departments.

Table 1 below includes the name, general description, and domain data for the attributes included in the *Port Infrastructure* layer.

Table 1. Port Infrastructure geodatabase layer information

Attribute Name	Description	Notes
Nav_Depth_ft	Quantifies the water depth (in feet) of the navigation channel accessing the port. Depths are relative to mean lower low water.	Depth may be variable within each port and are intended to be representative of the depths available for navigation to relevant facilities within each port.
Nav_Width_ft	Quantifies the available width (in feet) of the navigation channel accessing the port.	Nav Width is intended to be representative of the widths available for navigation to relevant facilities within each port. Specific areas within each port may have different available navigation widths.
Regional_Height_Limit_ft	Quantifies is approximate limiting vertical clearance (in feet) that is required to access the port, relative to mean high water.	Height limits may be variable within a single port, in which case the higher limitation is reported.
Prox_BOEM_Waters	Quantifies minimum distance from the port (in nautical miles) to federal water outside of state control, approximately 3 nautical miles from shore.	Ports with direct ocean access are assumed to have a value of 3 nautical miles.
Potential_Upland_AC	Quantifies potential land areas (in acres) that are either currently developed, may become available for development, or could be redeveloped for use in device or component fabrication, staging, or assembly.	
Access_Interstate	Indicates presence of Interstate access leading to a port property. Values include "I" indicating the presence of Interstate access or "NONE" indicating the absence of Interstate access.	To be included, existing Interstate leading to the port property must provide overland connections for fabrication and assembly support.
Access_Highway	Indicates presence of Highway access leading to a port property. Values include "H" indicating the presence of Highway access or "NONE" indicating the absence of Highway access.	To be included, existing Highway leading to the port property must provide overland connections for fabrication and assembly support.
Access_StateRoute	Indicates presence of State Route access leading to a port property. Values include "SR" indicating the presence of State Route access or "NONE " indicating the absence of State Route access.	To be included, existing State Route leading to the port property must provide overland connections for fabrication and assembly support.
Rail_Class_Access	Identifies railroad classification with existing access to port facilities. Does not necessarily require access direct to quayside areas. Values include "1" for Class 1 Rail, "2" for Class 2 Rail, and "3" For Class 3 Rail.	Class 1 rail are railroads with operating revenues of \$250 million or more. Class 2 rail are railroads with operating revenues of \$20 million - \$250 million. Class 3 rail are railroads with operating revenues of \$0 to \$20 million.
Workforce	Identifies potential population of skilled workforce available for manufacturing, fabrication, assembly of renewable energy device	Scoring is qualitative and based on cursory review the population of the metropolitan area and

Attribute Name	Description	Notes
Break_Bulk	components. Values include "High", "Medium", and "Low". Identifies if the port currently imports or exports general, project, or break bulk cargo. Values include "YES" and "NO".	general fabrication and marine industry capabilities.
Crane_Capacity_tons	Quantifies approximate crane capacity (in tons) currently existing at the port or other known facility in vicinity of the port.	Does not include cranes which may be rented for specific cargo or uses on a temporary basis.
Dry_Dock	Indicates if there is an active dry-dock in the vicinity of the port able to contain a ship and to be drained or lifted so as to leave the ship free of water with all parts of the hull accessible. Values include "YES" and "NO".	In some cases multiple port facilities are in the vicinity of a dry dock, in which case the dry dock was associated with the closest port.
Dry_Dock_Width_ft	For ports that include an existing dry dock facility, quantifies maximum interior width of widest dry dock associated with the port (in feet).	
Dry_Dock_Length_ft	For ports that include an existing dry dock facility, quantifies maximum interior length of longest dry dock associated with the port (in feet).	
Accommodate_500ft_Vessel	Identifies if a port can presently accommodate a vessel measuring 500 feet in length at dock/berth. Values include "YES" and "NO".	
Wind_Experience	Identifies if wind turbine operations have occurred at a port. Values include "YES" where wind turbine component handling is known to occur and "UNKNOWN" where wind turbine component handling is not known, but may have still occurred.	Information presents a cursory review of known wind turbine operations at each port, which is not intended to identify ports as never accommodating wind turbine components, only to note known occurrences.
Helipad_Vicinity	Identifies if a helipad for helicopter landing and take-off is located within approximately 10 miles of the port property. Values include: "YES", "NO", and "NA".	

L.2.2. Port Ratings Layer

The *Port Ratings* layer of the geodatabase includes the port assessment scores developed during the study. Based on existing technology, the *Port Ratings* layer of this geodatabase presents results of the assessments of ports following a conceptual-level scoring matrix, relative to technology- and function-specific criteria.

Each port was scored relative to the readiness and future capability to accommodate commercial- and demonstration-scale development Offshore Floating Wind (OFW) and Marine Hydrokinetic (MHK) technologies for Quick Reaction Port (QRP), Fabrication and Construction Port (FCP), and Assembly Port (AP) functions, based on an approximation of infrastructure required to accommodate commercial-scale development. Table 2 identifies the attributes included in this layer, provides a description of each, and identifies the port infrastructure criteria considered in developing ratings for each port.

Table 2. Port Ratings geodatabase layer information

Attribute Name	Description	Port Infrastructure Criteria Used in Rating
QR	Scores indicate the suitability of the port to function as a QRP. QRPs are intended to be the homeport for operations and maintenance vessels. The ports must be close enough to allow vessels to reach OFW and MHK energy installations site in less than two hours.	Nav Width, Nav Depth, Regional Height Limit, Proximity to BOEM Waters, Potential Upland Area w/ Marine Access
FCP_OFW_Wind_Turbine	Scores indicate the suitability of the port to function as an FCP to support fabrication and construction of OFW turbine device components, and import/export of materials and components.	Nav Width, Nav Depth, Metropolitan Area Skilled Labor Workforce Population, Proximity to BOEM Waters, Road and Rail Access, Potential Upland Area w/ Marine Access
FCP_OFW_Foundation	Scores indicate the suitability of the port to function as an FCP to support OFW foundation fabrication and construction applications.	Nav Width, Nav Depth, Metropolitan Area Skilled Labor Workforce Population, Proximity to BOEM Waters, Road and Rail Access, Potential Upland Area w/ Marine Access
FCP_MHK	Scores indicate the suitability of the port to function as an FCP to support MHK applications.	Nav Width, Nav Depth, Metropolitan Area Skilled Labor Workforce Population, Proximity to BOEM Waters, Road and Rail Access, Potential Upland Area w/ Marine Access
AP_Semi_Sub	Scores indicate the suitability of the port to function as an AP to OFW applications utilizing a semi-submersible foundation. This type of port will be utilized during final assembly of the entire devices for marine tow out to the installation location.	Nav Width, Nav Depth, Regional Height Limit, Potential Upland Area w/ Marine Access

Attribute Name	Description	Port Infrastructure Criteria Used in Rating
AP_TLP	Scores indicate the suitability of the port to function as an AP to OFW applications utilizing a tension-leg platform foundation. This type of port will be utilized during final assembly of the entire devices for marine tow out to the installation location.	Nav Width, Nav Depth, Regional Height Limit, Potential Upland Area w/ Marine Access.
AP_Spar	Scores indicate the suitability of the port to function as an AP to OFW applications utilizing a spar foundation. This type of port will be utilized during final assembly of the entire devices for marine tow out to the installation location. In this study, port capability to support spars is dependent on existing technology only.	Nav Width, Nav Depth, Regional Height Limit, Potential Upland Area w/ Marine Access
AP_MHK	Scores indicate the suitability of the port to function as an AP to MHK applications. This type of port will be utilized during final assembly of the entire devices for marine tow out to the installation location.	Nav Width, Nav Depth, Road and Rail Access, Upland Area w/ Marine Access

Specific projects or future technological developments may have different requirements and, therefore, different criteria may be needed for rating the level of capabilities each port may be able to provide. Future developments may have project-specific needs or efficiencies not assessed within the study and not reflected in this geodatabase.

The scoring matrix presented in Table 3 below and utilized in the *Port Ratings* layer is intended to estimate the relative levels of investment to support commercial-scale OFW and MHK, for existing installation technology. These ratings were developed to parameterize capabilities in the study area and to assess ports uniformly. The geodatabase layer also includes a field for color, with color values corresponding to the rating scores shown in Table 3.

Table 3. *Port Rating* geodatabase layer scoring matrix

Score	Definition
0	Was not assessed based on results of Pre-screening analysis
1	Does not meet primary criteria and is not suitable with existing technology due to not meeting one or more of the primary criteria (e.g. air draft restriction, upland area restrictions)
2	May not meet all primary criteria (such as available upland area), but temporary use of facilities will allow demonstration-scale project (e.g. staging area for 1 device is temporarily cleared at port).
3	Meets primary criteria. Land redevelopment, new purpose built marine terminal or berth required.
4	Meets primary criteria, and some secondary criteria. Moderate level of improvements needed, such as new high capacity (500+ tons) crane, existing berth upgrades, or berth bearing capacity investigation
5	Meets all primary criteria and most if not all secondary criteria. Minimal improvements are needed such as new small cargo crane (<10 tons), warehouses, helipad.

L.2.3. Regions with Gap Info Layer

As part of the port assessment carried out for the study, the gaps in key navigation access and infrastructure that would likely need to be addressed to support the port classification for each technology type were identified and included in the *Regions with Gap Info* layer of the geodatabase. For six study regions, the layer includes key gaps that would likely need to be addressed in order for the region to support commercial-scale OFW and MHK industries. Gaps for port classifications and technologies included in this layer were based on the regional gap identified during the study and identified in Chapter 6 of the Final Report. Figure 2 below provides an example map depicting the port rating and regional gaps for Fabrication and Construction Ports to support MHK created using the *Regions with Gap Info* layer.

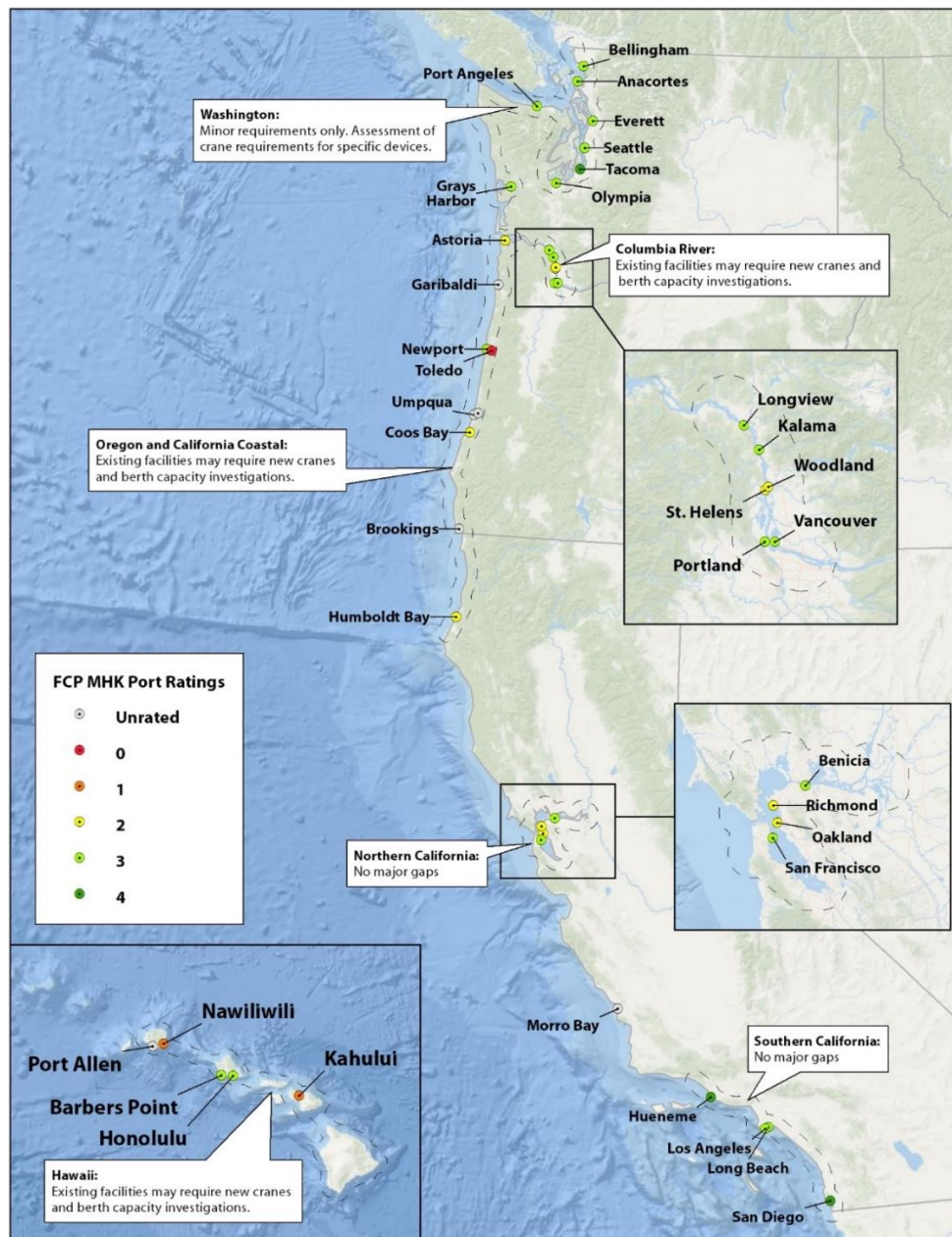

Figure 2. Example map presenting regional gap information and port rating for Fabrication and Construction Ports to support Marine Hydrokinetic development



The Department of the Interior Mission

As the Nation's principal conservation agency, the Department of the Interior has responsibility for most of our nationally owned public lands and natural resources. This includes fostering sound use of our land and water resources; protecting our fish, wildlife, and biological diversity; preserving the environmental and cultural values of our national parks and historical places; and providing for the enjoyment of life through outdoor recreation. The Department assesses our energy and mineral resources and works to ensure that their development is in the best interests of all our people by encouraging stewardship and citizen participation in their care. The Department also has a major responsibility for American Indian reservation communities and for people who live in island territories under US administration.



The Bureau of Ocean Energy Management

As a bureau of the Department of the Interior, the Bureau of Ocean Energy Management's (BOEM) primary responsibilities are to manage the mineral resources located on the Nation's Outer Continental Shelf (OCS) in an environmentally sound and safe manner.

The BOEM Environmental Studies Program

The mission of the Environmental Studies Program (ESP) is to provide the information needed to predict, assess, and manage impacts from offshore energy and marine mineral exploration, development, and production activities on human, marine, and coastal environments.