

UPDATED SUMMARY OF KNOWLEDGE: SELECTED AREAS OF THE PACIFIC COAST

Final Report



Updated Summary of Knowledge: Selected Areas of the Pacific Coast

Final Report

Editors

Bruce Kaplan
CJ Beegle-Krause
Deborah French McCay
Andrea Copping
Simon Geerlofs

Prepared under BOEMRE Contract
M08PD20170
by
Mangi Environmental Group
7927 Jones Branch Drive—Suite 150
McLean, VA 22102

Published by



Pacific OCS Region
July 2010

DISCLAIMER

This report was prepared under contract between the Bureau of Ocean Energy Management, Regulation, and Enforcement (BOEMRE) and Mangi Environmental Group (Mangi). This report has been technically reviewed by the BOEMRE and has been approved for publication. Approval does not signify that the contents necessarily reflect the views and policies of the BOEMRE, nor does mention of trade names or commercial products constitute endorsement or recommendation for use. It is, however, exempt from review and in compliance with BOEMRE editorial standards.

REPORT AVAILABILITY

Extra copies of this report may be obtained from the Public Information Office at the following address:

U.S. Department of the Interior
Bureau of Ocean Energy Management, Regulation, and Enforcement
Pacific OCS Region
770 Paseo Camarillo
Camarillo, California 93010

Telephone: 805-389-7533 or
1-800-672-2627

CITATION

Suggested Citation:

Kaplan, B., CJ Beegle-Krause, D. French McCay, A. Copping, S. Geerlofs, eds. 2010. Updated Summary of Knowledge: Selected Areas of the Pacific Coast. U.S. Dept. of the Interior, Bureau of Ocean Energy Management, Regulation, and Enforcement, Pacific OCS Region, Camarillo, CA. OCS Study BOEMRE 2010-014.

ACKNOWLEDGMENTS

The following authors were responsible for individual chapters in the report:

Northern Study Area

Chapters	Topic	Authors
1, 15	Physical Oceanography	Matthew K. Gough, Newell Garfield
2, 16	Geological Oceanography	Charlotte Sullivan, Gary Greene
3, 17	Chemical Oceanography	Jill Brandenburger
4, 18	Plankton	Andrea Copping
5, 19	Macrophytes	Andrea Copping
6, 20	Benthos	Roy Kropp
7, 21	Fish	John Vavrinec III
8, 22	Turtles	Eileen Graham
9, 23	Birds	Corey Duberstein
10	Marine Mammals (Resources)	Gretchen Steiger, John Calambokidis, Robin Baird
11, 25	Ecosystem Relationships	Andrea Copping
12, 26	Areas of Special concern	Simon Geerlofs
13, 27	Socioeconomics	Don Schug
24	Marine Mammals (Impacts)	Gretchen Steiger, John Calambokidis

Southern Study Area

Chapters	Topic	Authors
1	Physical Oceanography (Resources)	CJ Beegle-Krause, Matthew K. Gough, Newell Garfield
2, 16	Geological Oceanography	Charlotte Sullivan, Gary Greene
3	Chemical Oceanography (Resources)	David Valentine, James Payne, Ira Liefer
4, 18	Plankton	Eileen Graham
5, 19	Macrophytes	Eileen Graham
6, 20	Benthos	Melanie Schroeder
7, 21	Fish	Melanie Schroeder
8, 22	Turtles	Eileen Graham
9, 23	Birds	Eileen Graham
10	Marine Mammals	Gretchen Steiger, John Calambokidis, Robin Baird
11, 25	Ecosystem Relationships	Eileen Graham
12, 26	Areas of Special concern	Eileen Graham
13, 27	Socioeconomics	Don Schug
15	Physical Oceanography (Impacts)	CJ Beegle-Krause
17	Chemical Oceanography (Impacts)	David Valentine, James Payne, Richard Sweetman, Ira Liefer, CJ Beegle-Krause
24	Marine Mammals	Gretchen Steiger, John Calambokidis

In addition, the following individuals, institutions and organizations provided support for this project:

- Mangi Environmental Group—Pam Sarlouis, Jill Hacker, Chelsie Romulo, Lisa Edouard, Erica Earhart, Mark Blevins
- Applied Science Associates, Inc.—Felicita Wight, David Steube, Libe Washburn, Manuele DiLorenzo
- Pacific Northwest National Laboratory (operated by Battelle)
- Research4D
- Cascadia Research
- Northern Economics, Inc
- Ira Leifer, Marine Science Institute, University of California, Santa Barbara
- Gary Greene, Center for Habitat Studies at the Moss Landing Marine Laboratory
- David Valentine, Department of Geological Sciences, University of California, Santa Barbara
- Matthew K. Gough, Romberg Tiburon Center for Environmental Studies, San Francisco State University
- James Payne, Payne Environmental Consultants, Encinitas, CA

TABLE OF CONTENTS

	Page
TABLE OF CONTENTS.....	ix
LIST OF FIGURES	xxxv
LIST OF TABLES.....	xlv
ACRONYMS AND ABBREVIATIONS.....	xlix
A. INTRODUCTION	1
A.1 Background of the Study.....	1
A.2 Study Area (Maps)	1
A.3 Study Objectives.....	3
A.4 Study Methods.....	4
A.4.1 Research Plan.....	4
A.4.2 Literature Search.....	5
A.4.3 Annotated Bibliography.....	6
A.5 Structure of the Report	7
VOLUME I—NORTHERN STUDY AREA.....	11
PART I—NORTHERN STUDY AREA: RESOURCES.....	13
1. PHYSICAL OCEANOGRAPHY.....	15
1.1 Data Sources and Analyses	15
1.2 Seasonal Patterns.....	22
1.2.1 Winds.....	22
1.2.1.1 Spring/Summer Winds Along the Northern Study Area	25
1.2.1.2 Fall/Winter Winds Along the Northern Study Area	32
1.2.2 Currents.....	33
1.2.2.1 Currents Along the Northern Study Area During Spring/Summer.....	36
1.2.2.2 Currents Along the Northern Study Area During Fall/Winter.....	39
1.2.2.3 Seasonal Influences of Sea Surface Pressure Gradients and Freshwater Effluent and Buoyancy Flows.....	41
1.2.3 Upwelling.....	42
1.2.4 Water Properties.....	50
1.3 Subtidal Fluctuations.....	56
1.3.1 Currents.....	56
1.3.2 Columbia River Plume.....	61
1.3.3 Water Properties.....	63

1.4	Tidal and Supratidal Fluctuations.....	64
1.5	Interannual Fluctuations.....	69
1.6	Wave Climate.....	75
1.6.1	Directional Energy Spectrum.....	79
1.6.2	Variability Timescales.....	83
1.6.3	Connection With Littoral Processes and Sediment Transport.....	88
1.6.4	Available Energy.....	90
1.7	Summary and Data Gaps.....	94
1.8	List of Literature Cited—Physical Oceanography.....	98
2.	GEOLOGICAL OCEANOGRAPHY.....	105
2.1	Description and Physiography.....	105
2.1.1	Continental Shelf and Slope.....	107
2.1.2	Submarine Canyons and Sea Valleys.....	107
2.1.3	Seamounts.....	108
2.1.4	Ridges and Banks.....	108
2.1.5	Basins of the Continental Shelf and Slope.....	109
2.1.6	Deltas and Submarine Fans.....	109
2.2	Distribution and Fate of Chemical Constituents in Sediments.....	110
2.2.1	Sedimentary Organic Matter.....	110
2.2.2	Composition of Sedimentary Organic Matter.....	111
2.2.3	Trace Metals.....	111
2.2.4	Early Diagenetic Processes.....	111
2.3	Geologic Hazards.....	111
2.3.1	Scouring Action of Bottom Currents Including Turbidity Currents.....	112
2.3.2	Mass Wasting – Slope and Canyon Wall Failures.....	113
2.3.3	Faulting, Warping, and Deformation.....	114
2.3.4	Tsunamis.....	115
2.3.5	Fluid and Gas Expulsion (Overpressure Zones).....	117
2.3.6	Irregular and Hummocky Topography.....	117
2.3.7	Rilling, Gullying, and Sediment Transport.....	117
2.4	Summary and Data Gaps.....	120
2.5	List of Literature Cited—Geological Oceanography.....	121
3.	CHEMICAL OCEANOGRAPHY AND GEOCHEMISTRY.....	127
3.1	Sources of Organic Matter and Trace Elements.....	128
3.1.1	Autochthonous Sources.....	128
3.1.2	Allochthonous Sources.....	129
3.1.2.1	Organic Compounds.....	129
3.1.2.2	Inorganic Compounds.....	130
3.1.2.2.1	Nutrients.....	131
3.1.2.2.2	Dissolved Oxygen.....	135
3.1.2.2.3	Particulate Material.....	137
3.1.2.2.4	Trace Metals.....	138
3.1.2.2.5	Sulfur Compounds.....	139

3.2	Water Column Processes—Natural System Dynamics	139
3.3	Distribution and Fate of Chemical Constituents	139
3.3.1	Organic Matter	139
3.3.2	Composition of Organic Matter	141
3.3.3	Trace Metals.....	142
3.4	Summary and Data Gaps.....	143
3.5	List of Literature Cited—Chemical Oceanography	144
4.	PHYTOPLANKTON, ZOOPLANKTON, AND PELAGIC INVERTEBRATES.....	151
4.1	Species Composition	151
4.1.1	Phytoplankton Species Composition	151
4.1.2	Zooplankton Species Composition	152
4.2	Standing Stock of Zooplankton.....	153
4.3	Growth and Productivity	153
4.3.1	Phytoplankton Growth and Productivity	153
4.3.2	Zooplankton Growth and Productivity	156
4.4	Spatial and Temporal Patterns.....	157
4.4.1	Long-Term Fluctuations	157
4.4.2	Nearshore	158
4.4.3	Zone of Transition Between Inshore and Offshore Waters	158
4.4.4	Offshore	158
4.5	Pelagic Invertebrates	158
4.6	Summary and Data Gaps.....	159
4.7	List of Literature Cited—Plankton.....	160
5.	MACROPHYTES.....	165
5.1	Floristics and Biogeography.....	165
5.2	Patterns of Structure and Seasonal-Interannual Variation of Communities.....	166
5.2.1	Embayments: Salt Marshes, Lagoons, Modified Estuaries	166
5.2.2	Rocky Intertidal	167
5.2.3	Subtidal Kelp Forests.....	167
5.2.4	Floating Macroalgae	168
5.3	Macrophyte Productivity.....	168
5.4	Commercially and Recreationally Important Species	168
5.5	Summary and Data Gaps.....	168
5.6	List of Literature Cited—Macrophytes	169
6.	BENTHOS.....	171
6.1	Benthic Habitats and Assemblages	171
6.1.1	Shallow Intertidal and Subtidal Habitats and Benthic Assemblages.....	172
6.1.1.1	Rocky Intertidal.....	172
6.1.1.2	Sandy Beaches	174
6.1.1.3	Rocky Subtidal.....	174
6.1.1.4	Sandy and Other Soft-Bottom Subtidal	175
6.1.2	Deep Benthic Habitats and Assemblages	176
6.1.2.1	Rocky Substrate Assemblages	176
6.1.2.2	Soft Sediment Assemblages.....	178

6.1.2.3	Chemosynthetic Communities	179
6.2	Commercially and Recreationally Important Species	180
6.3	Threatened and Endangered Species	182
6.4	Summary and Data Gaps	182
6.5	List of Literature Cited—Benthos	183
7.	FISH	189
7.1	Zoogeography	189
7.1.1	Essential Fish Habitat	190
7.1.2	Spawning Areas	193
7.2	Life Histories	194
7.3	Commercial and Recreational Fishing	195
7.4	Threatened and Endangered Species	200
7.5	Fishes of the Pelagic Zone	203
7.5.1	Epipelagic	203
7.5.2	Ichthyoplankton	203
7.5.3	Mesopelagic and Bathypelagic	204
7.6	Fishes of Soft Substrates	204
7.7	Fishes of Hard Substrates and Kelp Beds	207
7.7.1	Rocky Intertidal	207
7.7.2	Rocky Reefs and Kelp Beds	207
7.7.3	Deep Reefs	212
7.8	Trophic Interactions	212
7.9	Summary and Data Gaps	213
7.10	List of Literature Cited—Fish	214
8.	SEA TURTLES	221
8.1	Migration	222
8.2	Foraging	223
8.3	Nesting	223
8.4	By-Catch	224
8.5	Summary and Data Gaps	224
8.6	List of Literature Cited—Sea Turtles	225
9.	BIRDS	227
9.1	Distribution and Abundance	227
9.1.1	Habitats	227
9.1.2	Marshbirds	229
9.1.3	Waterbirds	229
9.1.4	Shorebirds	230
9.1.5	Seabirds	231
9.1.6	Threatened and Endangered Species	234

9.2	Breeding and Reproductive Ecology.....	236
9.3	Foraging Ecology and Food Habits.....	236
9.4	Estimated Food Consumption.....	237
9.5	Migratory Flyways.....	237
9.6	Summary and Data Gaps.....	238
9.7	List of Literature Cited—Bird Resources.....	239
10.	MARINE MAMMALS.....	243
10.1	Introduction.....	243
10.2	Species Accounts.....	244
10.2.1	Blue Whale (<i>Balaenoptera musculus</i>).....	244
10.2.1.1	Distribution and Migration.....	244
10.2.1.2	Abundance.....	245
10.2.1.3	Foraging and Ecological Context.....	245
10.2.1.4	Status/Threats.....	245
10.2.2	Fin Whale (<i>Balaenoptera physalus</i>).....	246
10.2.2.1	Distribution and Migration.....	246
10.2.2.2	Abundance.....	246
10.2.2.3	Foraging and Ecological Context.....	246
10.2.2.4	Status/Threats.....	246
10.2.3	Sei whale (<i>Balaenoptera borealis</i>).....	247
10.2.3.1	Distribution and Migration.....	247
10.2.3.2	Abundance.....	247
10.2.3.3	Foraging and Ecological Context.....	247
10.2.3.4	Status/Threats.....	247
10.2.4	Minke Whale (<i>Balaenoptera acutorostrata</i>).....	247
10.2.4.1	Distribution and Migration.....	247
10.2.4.2	Abundance.....	248
10.2.4.3	Foraging and Ecological Context.....	248
10.2.4.4	Status/Threats.....	248
10.2.5	Humpback Whale (<i>Megaptera novaengliae</i>).....	249
10.2.5.1	Distribution and migration.....	249
10.2.5.2	Abundance.....	249
10.2.5.3	Foraging and Ecological Context.....	250
10.2.5.4	Status/Threats.....	250
10.2.6	North Pacific Right Whale (<i>Eubalaena japonica</i>).....	251
10.2.6.1	Distribution and Migration.....	251
10.2.6.2	Abundance.....	251
10.2.6.3	Foraging and Ecological Context.....	251
10.2.6.4	Status/Threats.....	251
10.2.7	Gray Whales (<i>Eschrichtius robustus</i>).....	252
10.2.7.1	Distribution and Migration.....	252
10.2.7.2	Abundance.....	252
10.2.7.3	Foraging and Ecological Context.....	253
10.2.7.4	Status/Threats.....	253
10.2.8	Sperm Whales (<i>Physeter macrocephalus</i>).....	254
10.2.8.1	Distribution and Migration.....	254

10.2.8.2	Abundance	254
10.2.8.3	Foraging and Ecological Context.....	254
10.2.8.4	Status/Threats.....	255
10.2.9	Kogia spp: Dwarf sperm Whales (<i>Kogia sima</i>) and Pygmy Sperm Whales (<i>Kogia breviceps</i>).....	255
10.2.9.1	Distribution and Migration.....	255
10.2.9.2	Abundance	255
10.2.9.3	Foraging and Ecological Context.....	255
10.2.9.4	Status/Threats.....	256
10.2.10	Beaked Whales.....	256
10.2.10.1	Distribution and Migration.....	256
10.2.10.2	Abundance	256
10.2.10.3	Foraging and Ecological Context.....	257
10.2.10.4	Status/Threats.....	257
10.2.11	Killer Whale (<i>Orcinus orca</i>).....	257
10.2.11.1	Distribution and Migration.....	257
10.2.11.2	Abundance	259
10.2.11.3	Foraging and Ecological Context.....	259
10.2.11.4	Status/Threats.....	259
10.2.12	Offshore Delphinids.....	260
10.2.12.1	Distribution and Migration.....	260
10.2.12.2	Abundance	260
10.2.12.3	Foraging and Ecological Context.....	260
10.2.12.4	Status/Threats.....	261
10.2.13	Other Tropical Delphinids	261
10.2.13.1	Distribution and Migration.....	261
10.2.13.2	Abundance	261
10.2.13.3	Foraging and Ecological Context.....	261
10.2.13.4	Status/Threats.....	262
10.2.14	Harbor Porpoise (<i>Phocoena phocoena</i>).....	262
10.2.14.1	Distribution and Migration.....	262
10.2.14.2	Abundance	262
10.2.14.3	Foraging and Ecological Context.....	262
10.2.14.4	Status/Threats.....	263
10.2.15	Dall's Porpoise (<i>Phocoenoides dalli</i>).....	263
10.2.15.1	Distribution and Migration.....	263
10.2.15.2	Abundance	263
10.2.15.3	Ecological Context.....	263
10.2.15.4	Status/Threats.....	263
10.2.16	Harbor Seals.....	264
10.2.16.1	Distribution and Migration.....	264
10.2.16.2	Abundance	264
10.2.16.3	Foraging and Ecological Context.....	265
10.2.16.4	Status/Threats.....	265
10.2.17	California Sea Lions	265
10.2.17.1	Distribution and Migration.....	265

10.2.17.2	Abundance	266
10.2.17.3	Foraging and Ecological Context.....	266
10.2.17.4	Status/Threats.....	266
10.2.18	Steller Sea Lion.....	267
10.2.18.1	Distribution and Migration.....	267
10.2.18.2	Abundance	267
10.2.18.3	Foraging and Ecological Context.....	267
10.2.18.4	Status/Threats.....	267
10.2.19	Northern Elephant Seal.....	268
10.2.19.1	Distribution and Migration.....	268
10.2.19.2	Abundance	268
10.2.19.3	Foraging and Ecological Context.....	268
10.2.19.4	Status/Threats.....	268
10.2.20	Northern Fur Seal.....	269
10.2.20.1	Distribution and Migration.....	269
10.2.20.2	Abundance	269
10.2.20.3	Foraging and Ecological Context.....	269
10.2.20.4	Status/Threats.....	270
10.2.21	Guadalupe Fur Seal.....	270
10.2.21.1	Distribution and Migration.....	270
10.2.21.2	Abundance	270
10.2.21.3	Foraging and Ecological Context.....	270
10.2.21.4	Status/Threats.....	270
10.2.22	Sea Otter.....	270
10.2.22.1	Distribution and Migration.....	270
10.2.22.2	Abundance	271
10.2.22.3	Foraging and Ecological Context.....	271
10.2.22.4	Status/Threats.....	271
10.3	List of Literature Cited—Marine Mammals	272
11.	ECOSYSTEM INTERRELATIONSHIPS	289
11.1	Comparison Of Trophic-Level Productivity Among Areas	289
11.2	Community Ecology.....	290
11.2.1	Ecosystem Food Chains and Energy Transfer	290
11.2.2	Ratios of Production at Different Trophic Levels.....	290
11.3	Population Biology (Island Biogeography Theory)	290
11.4	Summary and Data Gaps.....	291
11.5	List of Literature Cited—Ecosystem Relationships.....	292

12. AREAS OF SPECIAL CONCERN	295
12.1 Marine Sanctuaries	295
12.2 National Park System	300
12.3 National Wildlife Refuges	300
12.4 National Estuarine Research Reserves	301
12.5 National Estuary Program	302
12.6 Archaeological Sites	302
12.7 Weapons Dumping Grounds	303
12.8 State Marine Reserves	304
12.8.1 Washington State	304
12.8.2 Oregon	304
12.8.3 California	304
12.9 List of Literature Cited—Areas of Special Concern	306
13. SOCIOECONOMIC RESOURCES	309
13.1 Demographics	309
13.2 Economic Development	309
13.3 Sociocultural Systems	315
13.4 Environmental Justice	315
13.5 Infrastructure and Services	318
13.6 Visual Resources	319
13.7 Tourism and Recreation	319
13.8 Military Use Areas	322
13.9 Commercial and Recreational Fisheries	324
13.9.1 Commercial Fisheries	324
13.9.2 Recreational Fisheries	327
13.10 List of Literature Cited—Socioeconomic Resources	328
14. SUMMARY OF NATURAL RESOURCES	331
14.1 Physical Oceanography	331
14.2 Geological Oceanography	331
14.3 Chemical Oceanography and Geochemistry	332
14.4 Phytoplankton, Zooplankton and Pelagic Invertebrates	333
14.5 Macrophytes	334
14.6 Benthos	334
14.7 Fishes	335
14.8 Sea Turtles	335
14.9 Birds	335
14.10 Marine Mammals	336
14.11 Ecosystem Interrelationships	336
14.12 Areas of Special Concern	337
Part II—NORTHERN STUDY AREA: IMPACTS	339

15. PHYSICAL OCEANOGRAPHY	343
15.1 Effects on Air-Sea Flux and Upwelling	343
15.2 Effects on Wave Energy and Direction	344
15.3 Effects on Currents and Littoral Processes	347
15.4 Summary and Data Gaps	351
15.5 List of Literature Cited—Physical Oceanography	352
16. GEOLOGICAL OCEANOGRAPHY	355
16.1 Summary and Data Gaps	356
16.2 List of Literature Cited—Geological Oceanography	356
17. CHEMICAL AND GEOCHEMICAL OCEANOGRAPHY	359
17.1 Effects of Energy Removal	359
17.2 Chemical Contaminants	360
17.3 Effects of Increased vessel traffic	362
17.4 Summary and Data Gaps	363
17.5 List of Literature Cited—Chemical and Geochemical Oceanography	364
18. PHYTOPLANKTON, ZOOPLANKTON, AND PELAGIC INVERTEBRATES	367
18.1 Effects of Energy Removal	367
18.2 Water Entrainment	367
18.3 Chemical Contaminants	368
18.4 Noise and Electromagnetic Fields	368
18.5 Summary and Data Gaps	368
18.6 List of Literature Cited—Plankton, Zooplankton, and Pelagic Invertebrates	369
19. MACROPHYTES	371
19.1 Summary and Data Gaps	371
19.2 List of Literature Cited—Macrophytes	372
20. BENTHOS	373
20.1 Noise and Vibrations	373
20.2 Suspended Sediment and Sedimentation	373
20.3 Vessel Traffic	374
20.4 Chemical Leaching	374
20.5 Habitat Alteration	374
20.6 Changes to Surface Water Characteristics and Current Patterns	375
20.7 Summary and Data Gaps	376
20.8 List of Literature Cited—Benthos	376

21. FISH.....	379
21.1 Effect of Structures on the Marine Food Web	379
21.2 Effects on Migratory Patterns.....	380
21.3 Effects on Larval Stages.....	380
21.4 Effects on Threatened and Endangered Species.....	381
21.5 Noise and Vibrations during Development, Operation, and Removal of Structures ..	381
21.6 Effects of Electromagnetic Fields	383
21.7 Chemical Leaching (Paints, Antifouling Coatings)	383
21.8 Increased Vessel Traffic.....	384
21.9 Summary and Data Gaps.....	384
21.10 List of Literature Cited—Fish	385
22. SEA TURTLES	389
22.1 Noise and Vibrations.....	389
22.2 Increased Vessel Traffic.....	390
22.3 Entanglement.....	391
22.4 Chemical Contamination.....	391
22.5 Collision Potential	391
22.6 Electric and Magnetic Fields.....	392
22.7 Wastewater and Accidental Fuel Leaks	392
22.8 Alteration of the Marine Food Web	393
22.9 Summary and Data Gaps.....	393
22.10 List of Literature Cited—Sea Turtles.....	394
23. BIRDS.....	397
23.1 Noise and Vibration During Development.....	397
23.2 Increased Vessel Traffic.....	397
23.3 Wastewater and Accidental Fuel Leaks	397
23.4 Marine Food Web Alteration	398
23.5 Impacts of Infrastructure	398
23.5.1 Continuous Lighting and Structure Collision	398
23.5.2 Migratory Pathway Alteration	399
23.6 Effects of Many Large, Stationary Devices on Migratory Patterns	400
23.7 Effects of Electromagnetic Fields	400
23.8 Summary and Data Gaps.....	401
23.9 List of Literature Cited—Birds	401
24. MARINE MAMMALS.....	405
24.1 Impacts of Noise During Development, Operation, and Decommissioning.....	406
24.2 Effects of Seismic Surveys.....	408
24.3 Effects of Vessel Traffic.....	410
24.4 Effects of Entanglement in Cables	411
24.5 Other Effects.....	412
24.6 Summary of Data Gaps	412
24.7 List of Literature Cited—Marine Mammals	413

25. ECOSYSTEM INTERRELATIONSHIPS	423
25.1 Changes in Food Web Production.....	423
25.2 Changes in Predation, Competition, and Disease.....	424
25.3 Summary and Data Gaps.....	424
25.4 List of Literature Cited—Ecosystem Interrelationships.....	425
26. AREAS OF SPECIAL CONCERN	427
26.1 Summary and Data Gaps.....	427
26.2 List of Literature Cited—Areas of Special Concern	427
27. SOCIOECONOMIC IMPACTS.....	429
27.1 Public Participation	430
27.2 Space-Use Conflicts	433
27.2.1 Commercial and Recreational Fisheries	433
27.2.2 Visual Impacts	434
27.2.3 Transportation and Navigation	435
27.3 Economic Development	435
27.4 Public Policy and Governance	437
27.5 Additional Areas of Social, Cultural, and Economic Interest.....	439
27.5.1 Infrastructure and Services	439
27.5.2 Recreation and Tourism.....	439
27.5.3 Human Health and Safety.....	440
27.5.4 Military Use Areas.....	440
27.6 Available Information & Data Gaps	441
27.6.1 Commercial and Recreational Fisheries	441
27.6.2 Visual Resources and Aesthetics	442
27.6.3 Transportation and Navigation	443
27.6.4 Economic Development.....	444
27.7 List of Literature Cited—Socioeconomic Impacts.....	445
28. SUMMARY OF IMPACTS	455
29. SUMMARY OF DATA GAPS	457
29.1 Physical Oceanography	457
29.1.1 Resource Data Gaps.....	457
29.1.2 Impact Data Gaps.....	458
29.2 Geological Oceanography	459
29.2.1 Resource Data Gaps.....	459
29.2.2 Impact Data Gaps.....	459
29.3 Chemical Oceanography	459
29.3.1 Resource Data Gaps.....	459
29.3.2 Impact Data Gaps.....	459
29.4 Phytoplankton, Zooplankton, Pelagic Invertebrates.....	460
29.4.1 Resource Data Gaps.....	460
29.4.2 Impact Data Gaps.....	460

29.5	Macrophytes	461
29.6	Benthos	461
	29.6.1 Resource Data Gaps	461
	29.6.2 Impact Data Gaps	461
29.7	Fish	461
	29.7.1 Resource Data Gaps	461
	29.7.2 Impact Data Gaps	462
29.8	Sea Turtles	462
	29.8.1 Resource Data Gaps	462
	29.8.2 Impact Data Gaps	462
29.9	Birds	463
	29.9.1 Resource Data Gaps	463
	29.9.2 Impact Data Gaps	463
29.10	Marine Mammals	463
	29.10.1 Resource Data Gaps	463
	29.10.2 Impact Data Gaps	464
29.11	Ecosystem Relationships	464
29.12	Areas of Special Concern	464
29.13	Socioeconomics	464
VOLUME II—SOUTHERN STUDY AREA		467
PART I—SOUTHERN STUDY AREA: RESOURCES		469
1.	PHYSICAL OCEANOGRAPHY	471
1.1	Data Sources and Analysis	471
1.2	Seasonal Patterns	476
	1.2.1 Winds	476
	1.2.1.1 Santa Barbara Channel	479
	1.2.2 Currents	481
	1.2.2.1 Santa Barbara Channel	483
	1.2.2.2 Santa Monica Bay	483
	1.2.2.3 Upwelling	483
	1.2.3 Water Properties	486
	1.2.3.1 Temperature	489
	1.2.3.2 Salinity	490
1.3	Subtidal Fluctuations	491
	1.3.1 Currents	491
	1.3.1.1 Santa Maria Basin	491
	1.3.1.2 Santa Barbara Channel	492
	1.3.2 Water Properties	493
	1.3.2.1 Temperature	493
	1.3.2.2 Salinity	493
1.4	Tidal and Supratidal Fluctuations	493
1.5	Interannual Fluctuations	496
	1.5.1 El Niño	498
	1.5.2 Pacific Decadal Oscillation	500

1.5.3	North Pacific Gyre Oscillation.....	502
1.5.4	Longer Period Cycles.....	503
1.6	Basin Water Renewal	505
1.7	Wave Climate.....	506
1.7.1	Directional Energy Spectrum.....	509
1.7.2	Variability Timescales	511
1.7.3	Connection with Littoral Processes and Sediment Transport.....	514
1.8	Summary and Data Gaps.....	516
1.9	List of Literature Cited—Physical Oceanography	518
2.	GEOLOGICAL OCEANOGRAPHY.....	525
2.1	Description and Physiography.....	526
2.1.1	Continental Shelf and Slope.....	527
2.1.2	Submarine Canyons and Sea Valleys	527
2.1.3	Seamounts.....	528
2.1.4	Ridges and Banks.....	529
2.1.5	Basins of the Continental Shelf and Slope.....	529
2.1.6	Deltas and Submarine Fans.....	529
2.2	Distribution and Fate of Chemical Constituents in Sediments.....	530
2.2.1	Sedimentary Organic Matter.....	530
2.2.2	Composition of Sedimentary Organic Matter.....	531
2.2.3	Trace Metals.....	531
2.2.4	Early Diagenetic Processes	531
2.3	Geologic Hazards	532
2.3.1	Scouring Action of Bottom Currents Including Turbidity Currents.....	532
2.3.2	Mass Wasting – Slope and Canyon Wall Failures.....	533
2.3.3	Faulting, Warping, and Deformation	535
2.3.4	Tsunamis.....	537
2.3.5	Fluid and Gas Expulsion (Overpressure Zones).....	538
2.3.6	Irregular and Hummocky Topography	538
2.3.7	Rilling, Gullying, and Sediment Transport.....	538
2.4	Summary and Data Gaps.....	541
2.5	List of Literature—Geological Oceanography	542
3.	CHEMICAL OCEANOGRAPHY AND GEOCHEMISTRY.....	549
3.1	Sources of Organic Matter and Trace Elements.....	549
3.1.1	Autochthonous Sources	549
3.1.2	Allochthonous Sources	551
3.1.2.1	Organic Compounds	551
3.1.2.2	Inorganic Compounds.....	554
3.1.2.2.1	Nutrients	554
3.1.2.2.2	Dissolved Oxygen.....	555
3.1.2.2.3	Particulate Material.....	555
3.1.2.2.4	Trace Metals	556
3.1.2.2.5	Sulfur Compounds.....	557

3.2	Water Column Processes – Natural System Dynamics	558
3.3	Distribution and Fate of Chemical Constituents	558
3.3.1	Organic Matter	558
3.3.2	Composition of Organic Matter	563
3.3.3	Trace Metals.....	565
3.4	The Petroleum Seeps	565
3.4.1	Marine Seep Overview—What Is a Seep?.....	565
3.4.2	Hydrocarbon Migration from the Reservoir to the Seabed.....	566
3.4.2.1	Control of Seepage by Faults and Fractures	566
3.4.2.2	Reservoir Layer Accumulation and Migration in the Reservoir Layer	567
3.4.2.3	Outcropping Seepage	569
3.4.2.4	Overburden Control of Seepage.....	571
3.4.3	Temporal Variations in Emissions.....	572
3.4.3.1	Overview	572
3.4.3.2	Geologic Control of Temporal Variations in Migration Pathways.....	573
3.4.3.3	Transient Emissions	575
3.4.3.4	Tar Deposition at the Seabed	576
3.4.4	Transport from Seabed to Sea Surface.....	576
3.4.4.1	Overview	576
3.4.4.2	Single Bubble/Droplet Transport	577
3.4.4.3	Plume Transport.....	578
3.4.4.4	Megaplume Transport	578
3.4.4.5	Transient Emissions	579
3.4.4.6	Currents.....	579
3.4.4.7	Stratification.....	580
3.4.4.8	Oil and Tar Emissions.....	580
3.4.5	Sea Surface Transport and Chemistry	581
3.4.5.1	Overview	581
3.4.5.2	Evaporation	582
3.4.5.3	Spreading	583
3.4.5.4	Advection	583
3.4.5.5	Miscellaneous Processes (Photolysis, Emulsification)	583
3.4.5.6	Sinking	584
3.4.6	Tar Processes	584
3.4.6.1	Overview	584
3.4.6.2	Beach Accumulation.....	585
3.4.7	Oil and Gas Seep Ecology	585
3.4.7.1	Microbial.....	585
3.4.7.2	Higher Trophic Levels	586
3.5	Summary and Data Gaps.....	586
3.6	List of Literature Cited—Chemical Oceanography	588

4.	PHTYOPLANKTON, ZOOPLANKTON, AND PELAGIC INVERTEBRATES	603
4.1	Species Composition of Plankton	603
4.2	Standing Stock of Plankton	604
4.3	Growth and Productivity of Plankton	604
4.4	Spatial and Temporal Patterns of Plankton	605
4.4.1	Long-Term Fluctuations	605
4.4.2	Nearshore	605
4.4.3	Transition Zone	606
4.4.4	Offshore	606
4.4.5	Neuston	606
4.5	Pelagic Invertebrates	607
4.6	Summary and Data Gaps	607
4.7	List of Literature Cited—Phytoplankton	608
5.	MACROPHYTES	611
5.1	Floristics and Biogeography	611
5.2	Patterns of Structure and Seasonal-Interannual Variation of Communities	611
5.2.1	Embayments: Salt Marshes, Lagoons, Modified Estuaries	611
5.2.2	Rocky Intertidal	613
5.2.3	Subtidal Kelp Forests	613
5.2.4	Floating Macroalgae	614
5.3	Macrophyte Productivity	615
5.4	Commercially and Recreationally Important Species	615
5.5	Summary and Data Gaps	615
5.6	List of Literature Cited—Macrophytes	616
6.	BENTHOS	619
6.1	Benthic Habitats and Assemblages	619
6.1.1	Shallow Intertidal and Subtidal Habitats and Assemblages	620
6.1.1.1	Rocky Intertidal	620
6.1.1.2	Sandy Beaches	624
6.1.1.3	Rocky Subtidal	625
6.1.1.4	Sandy Subtidal	628
6.1.1.5	Embayment Assemblage	630
6.1.2	Deep Benthic Habitats and Assemblages	631
6.1.2.1	Rocky Substrate Assemblages	631
6.1.2.2	Soft Sediment Assemblages	632
6.1.2.3	Chemosynthetic Communities	634
6.2	Commercially and Recreationally Important Species	634
6.3	Threatened and Endangered Species	635
6.4	Summary and Data Gaps	635
6.5	List of Literature Cited—Benthos	636
7.	FISH	643
7.1	Zoogeography	643
7.1.1	Essential Fish Habitat	643
7.1.2	Spawning Grounds	645

7.2	Life Histories.....	646
7.3	Commercial and Recreational Fishing.....	647
7.4	Threatened and Endangered Species.....	648
7.5	Fishes of the Pelagic Zone.....	650
7.5.1	Epipelagic.....	650
7.5.2	Ichthyoplankton.....	651
7.5.3	Neuston.....	654
7.5.4	Mesopelagic and Bathypelagic.....	655
7.6	Fishes of Soft Substrates.....	655
7.7	Fishes of Hard Substrates and Kelp Beds.....	658
7.7.1	Rocky Intertidal.....	658
7.7.2	Rocky Reefs and Kelp Beds.....	659
7.7.3	Deep Reefs.....	660
7.8	Trophic Interactions.....	660
7.9	Summary and Data Gaps.....	661
7.10	List of Literature Cited—Fish.....	662
8.	SEA TURTLES.....	669
8.1	Migration.....	670
8.2	Foraging.....	671
8.3	Nesting.....	672
8.4	By-Catch.....	672
8.5	Summary and Data Gaps.....	673
8.6	List of Literature Cited—Sea Turtles.....	673
9.	BIRDS.....	677
9.1	Habitats.....	677
9.2	Distribution and Abundance.....	678
9.2.1	Marshbirds.....	678
9.2.2	Waterbirds.....	678
9.2.3	Shorebirds.....	679
9.2.4	Seabirds.....	680
9.2.5	Raptors.....	682
9.3	Breeding and Reproductive Ecology.....	683
9.4	Foraging Ecology and Food Habits.....	684
9.4.1	Estimated Food Consumption.....	685
9.5	Migratory Flyways.....	685
9.6	Threatened and Endangered Species.....	685
9.7	Summary and Data Gaps.....	688
9.8	List of Literature Cited—Birds.....	688
10.	MARINE MAMMALS.....	693
10.1	Introduction.....	693
10.2	Species Accounts.....	694
10.2.1	Blue Whale (<i>Balaenoptera musculus</i>).....	694
10.2.1.1	Distribution and Migration.....	694
10.2.1.2	Abundance.....	695

10.2.1.3	Foraging and Ecological Context.....	695
10.2.1.4	Status/Threats.....	695
10.2.2	Fin Whale (<i>Balaenoptera physalus</i>).....	696
10.2.2.1	Distribution and Migration.....	696
10.2.2.2	Abundance.....	696
10.2.2.3	Foraging and Ecological Context.....	696
10.2.2.4	Status/Threats.....	696
10.2.3	Sei Whale (<i>Balaenoptera borealis</i>).....	697
10.2.3.1	Distribution and Migration.....	697
10.2.3.2	Abundance.....	697
10.2.3.3	Foraging and Ecological Context.....	697
10.2.3.4	Status/Threats.....	697
10.2.4	Bryde's Whale (<i>Balaenoptera edeni</i>).....	697
10.2.4.1	Distribution and Migration.....	697
10.2.4.2	Abundance.....	698
10.2.4.3	Foraging and Ecological Context.....	698
10.2.4.4	Status/Threats.....	698
10.2.5	Humpback Whale (<i>Megaptera novaeangliae</i>).....	698
10.2.5.1	Distribution and Migration.....	698
10.2.5.2	Abundance.....	699
10.2.5.3	Foraging and Ecological Context.....	700
10.2.5.4	Status/Threats.....	700
10.2.6	Minke Whale (<i>Balaenoptera acutorostrata</i>).....	700
10.2.6.1	Distribution and Migration.....	700
10.2.6.2	Abundance.....	701
10.2.6.3	Foraging and Ecological Context.....	701
10.2.6.4	Status/Threats.....	701
10.2.7	North Pacific Right Whale (<i>Eubalaena japonica</i>).....	701
10.2.7.1	Distribution and Migration.....	701
10.2.7.2	Abundance.....	702
10.2.7.3	Foraging and Ecological Context.....	702
10.2.7.4	Status/Threats.....	702
10.2.8	Gray Whales (<i>Eschrichtius robustus</i>).....	702
10.2.8.1	Distribution and Migration.....	702
10.2.8.2	Abundance.....	703
10.2.8.3	Foraging and Ecological Context.....	703
10.2.8.4	Status/Threats.....	704
10.2.9	Sperm Whales (<i>Physeter macrocephalus</i>).....	704
10.2.9.1	Distribution and Migration.....	704
10.2.9.2	Abundance.....	705
10.2.9.3	Foraging and Ecological Context.....	705
10.2.9.4	Status/Threats.....	705
10.2.10	Kogia spp: Dwarf Sperm Whales (<i>Kogia sima</i>) and Pygmy Sperm Whales (<i>Kogia breviceps</i>).....	705
10.2.10.1	Distribution and Migration.....	705
10.2.10.2	Abundance.....	706

10.2.10.3 Foraging and Ecological Context.....	706
10.2.10.4 Status/Threats.....	706
10.2.11 Beaked Whales.....	706
10.2.11.1 Distribution and Migration.....	706
10.2.11.2 Abundance	707
10.2.11.3 Foraging and Ecological Context.....	707
10.2.11.4 Status/Threats.....	707
10.2.12 Killer Whale (<i>Orcinus orca</i>).....	707
10.2.12.1 Distribution and Migration.....	707
10.2.12.2 Abundance	709
10.2.12.3 Foraging and Ecological Context.....	709
10.2.12.4 Status/Threats.....	709
10.2.13 Common Dolphin-Short-Beaked and Long-Beaked (<i>Delphinus delphus</i> and <i>D. capensis</i>)	710
10.2.13.1 Distribution and Migration.....	710
10.2.13.2 Abundance	710
10.2.13.3 Foraging and Ecological Context.....	710
10.2.13.4 Status/Threats.....	711
10.2.14 Bottlenose Dolphin (<i>Tursiops truncatus</i>).....	711
10.2.14.1 Distribution and Migration.....	711
10.2.14.2 Abundance	711
10.2.14.3 Foraging and Ecological Context.....	712
10.2.14.4 Status/Threats.....	712
10.2.15 Offshore Delphinids.....	712
10.2.15.1 Distribution and Migration.....	712
10.2.15.2 Abundance	713
10.2.15.3 Foraging and Ecological Context.....	713
10.2.15.4 Status/Threats.....	713
10.2.16 Other Tropical Delphinids in the Southern California Bight.....	713
10.2.16.1 Distribution and Migration.....	713
10.2.16.2 Abundance	714
10.2.16.3 Foraging and Ecological Context.....	714
10.2.16.4 Status/Threats.....	714
10.2.17 Dall's Porpoise (<i>Phocoenoides dalli</i>)	714
10.2.17.1 Distribution and Migration.....	714
10.2.17.2 Abundance	714
10.2.17.3 Foraging and Ecological Context.....	715
10.2.17.4 Status/Threats.....	715
10.2.18 Harbor Seals (<i>Phoca vitulina</i>).....	715
10.2.18.1 Distribution and Migration.....	715
10.2.18.2 Abundance	715
10.2.18.3 Foraging and Ecological Context.....	716
10.2.18.4 Status/Threats.....	716
10.2.19 California Sea Lions (<i>Zalophus californianus</i>).....	716
10.2.19.1 Distribution and Migration.....	716
10.2.19.2 Abundance	717

10.2.19.3	Foraging and Ecological Context.....	717
10.2.19.4	Status/Threats.....	717
10.2.20	Steller Sea Lion (<i>Eumetopias jubatus</i>)	718
10.2.20.1	Distribution and Migration.....	718
10.2.20.2	Abundance	718
10.2.20.3	Foraging and Ecological Context.....	718
10.2.20.4	Status/Threats.....	718
10.2.21	Northern Elephant Seal (<i>Mirounga angustirostris</i>)	719
10.2.21.1	Distribution and Migration.....	719
10.2.21.2	Abundance	719
10.2.21.3	Foraging and Ecological Context.....	719
10.2.21.4	Status/Threats.....	719
10.2.22	Northern Fur Seal (<i>Callorhinus ursinus</i>)	720
10.2.22.1	Distribution and Migration.....	720
10.2.22.2	Abundance	720
10.2.22.3	Foraging and Ecological Context.....	720
10.2.22.4	Status/Threats.....	721
10.2.23	Guadalupe Fur Seal (<i>Arctocephalus townsendi</i>).....	721
10.2.23.1	Distribution and Migration.....	721
10.2.23.2	Abundance	721
10.2.23.3	Foraging and Ecological Context.....	721
10.2.23.4	Status/Threats.....	721
10.2.24	Sea Otter (<i>Enhydra lustris</i>).....	721
10.2.24.1	Distribution and Migration.....	721
10.2.24.2	Abundance	722
10.2.24.3	Foraging and Ecological Context.....	722
10.2.24.4	Status/Threats.....	722
10.3	List of Literature Cited—Marine Mammals	723
11.	ECOSYSTEM INTERRELATIONSHIPS	741
11.1	Comparison of Trophic Level Productivity among Areas	741
11.1.1	Ecosystem Food Chains and Energy Transfer	741
11.1.2	Ratios of Production at Different Trophic Levels.....	741
11.2	Community Ecology.....	742
11.2.1	Island Biogeography Theory.....	742
11.3	Summary and Data Gaps	743
11.4	List of Literature Cited—Ecosystem Interrelationships.....	743

12. AREAS OF SPECIAL CONCERN	745
12.1 Marine Sanctuaries	745
12.2 National Park System	746
12.3 National Wildlife Refuges	746
12.4 National Estuarine Research Reserves	746
12.5 National Estuary Program	746
12.6 Archeological sites (e.g. Shipwrecks)	747
12.7 Weapons and Chemical Dumping Grounds	747
12.8 California State Protected Areas	748
12.9 Summary and Data Gaps	748
12.10 List of Literature Cited—Areas of Special Concern	748
13. SOCIOECONOMIC RESOURCES	751
13.1 Demographic	751
13.2 Economic Development	751
13.3 Sociocultural Systems	753
13.4 Environmental Justice	754
13.5 Infrastructure and Services	755
13.6 Visual Resources	756
13.7 Tourism and Recreation	757
13.8 Military Use Areas	758
13.9 Commercial and Recreational Fisheries	759
13.9.1 Commercial Fisheries	759
13.9.2 Recreational Fisheries	762
13.10 List of Literature Cited—Socioeconomic Resources	763
14. SUMMARY OF NATURAL RESOURCES	765
14.1 Physical Oceanography	765
14.2 Geological Oceanography	765
14.3 Chemical Oceanography and Geochemistry	766
14.4 Phytoplankton, Zooplankton and Pelagic Invertebrates	767
14.5 Macrophytes	767
14.6 Benthos	768
14.7 Fishes	768
14.8 Sea Turtles	768
14.9 Birds	769
14.10 Marine Mammals	769
14.11 Ecosystem Interrelationships	769
14.12 Areas of Special Concern	770
Part II—SOUTHERN STUDY AREA: IMPACTS	771
15. PHYSICAL OCEANOGRAPHY	775
15.1 Effects of Continued Infrastructure on Local Ocean Dynamics	775
15.1.1 Effects on the Water’s Movement	775
15.1.2 Effects Due to Changing the Water’s Movement	776

15.2	Summary and Data Gaps	776
15.3	List of Literature Cited—Impacts on Physical Oceanography	777
16.	GEOLOGICAL OCEANOGRAPHY	779
16.1	Bedform Migration Effects from Siting of Energy Facilities	780
16.2	Sediment Transport Effects from The Presence of Facilities	780
16.3	Adverse Erosion and Scouring	780
16.4	Adverse Sediment Deposition	781
	16.4.1 Generation of Mass Movements	781
	16.4.2 Seafloor Collapse	782
16.5	Summary and Data Gaps	783
16.6	List of Literature Cited—Geology	784
17.	CHEMICAL AND GEOCHEMICAL OCEANOGRAPHY	787
17.1	Leaching of Chemicals (Paints and Antifouling Coatings)	787
17.2	Chemicals Modulated During Development, Operation, and Removal of Structures	788
17.3	Effects of Increased Vessel Traffic	790
17.4	Subsea Production	792
	17.4.1 Sediment Displacement	793
	17.4.1.1 Heavy Metals and/or Hydrocarbons	793
	17.4.2 Bottom Debris	794
17.5	Operational Discharge	795
	17.5.1 Treatment, Workover, and Completion (TWC) Fluids	795
	17.5.2 Drilling Muds and Cuttings and Subsequent Increase in Turbidity	796
	17.5.3 Produced Waters	798
17.6	Effects of Produced Water Discharges	800
17.7	Air Emissions	805
17.8	Effects of H ₂ S	805
17.9	Summary and Data Gaps	806
17.10	List of Literature Cited—Chemical Oceanography	808
18.	PHYTOPLANKTON, ZOOPLANKTON, AND PELAGIC INVERTEBRATES	817
18.1	Noise and Vibration	817
18.2	Increased Turbidity	817
18.3	Wastewater	817
18.4	Entrainment	818
18.5	Increased Vessel Traffic	818
18.6	Chemical Contamination and Oil Spills	818
18.7	Summary and Data Gaps	820
18.8	List of Literature Cited—Phytoplankton	820

19. MACROPHYTES.....	823
19.1 Sediment Displacement.....	823
19.2 Increased Vessel Traffic.....	823
19.3 Entrainment and Entanglement.....	823
19.4 Drilling Muds and Cuttings.....	824
19.5 Wastewater.....	824
19.6 Chemical Contamination and Oil Spills.....	824
19.7 Summary and Data Gaps.....	825
19.8 List of Literature Cited—Macrophytes.....	826
20. BENTHOS.....	829
20.1 Habitat Alteration.....	829
20.2 Suspended Sediment and Sedimentation.....	830
20.3 Increased Vessel Traffic and Water Usage.....	831
20.4 Drilling Muds and Cuttings.....	831
20.5 Wastewater.....	832
20.6 Noise and Vibration.....	832
20.7 Chemical Contamination and Oil Spills.....	832
20.8 Recovery of Benthic Habitats.....	835
20.8.1 Oil Spills.....	835
20.8.2 Physical Disturbance.....	835
20.9 Summary and Data Gaps.....	836
20.10 List of Literature Cited—Benthos.....	836
21. FISH.....	843
21.1 Habitat Alteration.....	843
21.2 Suspended Sediment and Sedimentation.....	845
21.3 Increased Vessel Traffic and Water Usage.....	846
21.4 Drilling Muds and Cuttings.....	846
21.5 Wastewater.....	847
21.6 Noise and Vibration.....	847
21.7 Artificial Lighting.....	847
21.8 Chemical Contamination and Oil Spills.....	848
21.9 Hydrogen Sulfide.....	849
21.10 Threatened and Endangered Species.....	849
21.11 Summary and Data Gaps.....	850
21.12 List of Literature Cited—Fish.....	850

22. SEA TURTLES	855
22.1 Noise and Vibrations	855
22.2 Increased Vessel Traffic	856
22.3 Entanglement	857
22.4 Drilling Muds and Cuttings	857
22.5 Wastewater	857
22.6 Chemical Contamination and Oil Spills	858
22.7 Air Emissions	860
22.8 Hydrogen Sulfide	860
22.9 Alteration of the Marine Food Web	860
22.10 Summary and Data Gaps	861
22.11 List of Literature Cited—Sea Turtles	861
23. BIRDS	865
23.1 Increased Vessel Traffic	865
23.2 Noise and Vibrations	866
23.3 Infrastructure	866
23.4 Oil Spills	867
23.5 Air Emissions and Hydrogen Sulfide	869
23.6 Threatened and Endangered Species	870
23.7 Summary and Data Gaps	870
23.8 List of References Cited—Birds	871
24. MARINE MAMMALS	877
24.1 Impacts of Noise	877
24.1.1 Seismic Surveys	878
24.1.2 Construction and Dredging	882
24.1.3 Drilling and Operation	883
24.1.4 Vessel Traffic and Transport	884
24.1.5 Explosions During Construction or Demolition	884
24.2 Impacts of Exposure to Oil	885
24.3 Impacts of Collisions with Vessels or Infrastructure	886
24.3.1 Ship Strikes	886
24.3.2 Entanglement in Cables	886
24.4 Summary of Data Gaps	887
24.4.1 Biological Data Gaps	887
24.4.2 Gaps in Research on Impacts	888
24.5 List of Literature Cited—Marine Mammals	889
25. ECOSYSTEM INTERRELATIONSHIPS	897
25.1 Alteration of the Marine Food Web	897
25.2 Patterns of Predation, Competition, and Disease	898
25.3 Summary and Data Gaps	899
25.4 List of Literature Cited—Ecosystem Interrelationships	899

26. AREAS OF SPECIAL CONCERN	903
26.1 Contamination of Pristine Areas	903
26.2 Resuspension of Sediments and Deposits	903
26.3 Summary and Data Gaps	904
26.4 List of Literature Cited—Areas of Special Concern	904
27. SOCIOECONOMIC IMPACTS	905
27.1 Public Attitudes and Perceptions	905
27.2 Commercial and Recreational Fisheries	909
27.3 Public Policy and Governance	910
27.4 Additional Areas of Social, Cultural, and Economic Interest	912
27.4.1 Economic Development	912
27.4.2 Infrastructure and Services	913
27.4.3 Transportation and Navigation	913
27.4.4 Recreation and Tourism	914
27.4.5 Safety and Lifestyle	914
27.4.6 Military Use Areas	915
27.5 Available Information & Data Gaps	915
27.5.1 Visual Resources and Aesthetics	915
27.5.2 Commercial and Recreational Fisheries	916
27.6 List of Literature Cited—Socioeconomic Impacts	917
28. SUMMARY OF OIL AND GAS IMPACTS	929
28.1 Installation, Operation, and Removal	929
28.2 Oil Spills	929
29. SUMMARY OF DATA GAPS	931
29.1 Physical Oceanography	931
29.1.1 Resource Data Gaps	931
29.1.2 Impact Data Gaps	931
29.2 Geological Oceanography	932
29.2.1 Resource Data Gaps	932
29.2.2 Impact Data Gaps	932
29.3 Chemical Oceanography	932
29.3.1 Resource Data Gaps	932
29.3.2 Impact Data Gaps	933
29.4 Phytoplankton, Zooplankton, Pelagic Invertebrates	934
29.4.1 Resource Data Gaps	934
29.4.2 Impact Data Gaps	934
29.5 Macrophytes	935
29.6 Benthos	935
29.6.1 Resource Data Gaps	935
29.6.2 Impact Data Gaps	935
29.7 Fish	935
29.7.1 Resource Data Gaps	935
29.7.2 Impact Data Gaps	936

29.8	Sea Turtles	936
29.8.1	Resource Data Gaps	936
29.8.2	Impact Data Gaps	936
29.9	Birds	936
29.9.1	Resource Data Gaps	936
29.9.2	Impact Data Gaps	937
29.10	Marine Mammals	937
29.10.1	Resource Data Gaps	937
29.10.2	Impact Data Gaps	937
29.11	Ecosystem Relationships	937
29.11.1	Resource Data Gaps	937
29.11.2	Impact Data Gaps	938
29.12	Areas of Special Concern	938
29.13	Socioeconomics	938

LIST OF FIGURES

VOLUME I—NORTHERN STUDY AREA	Page
Figure A.1. Northern Study Area.....	2
Figure A.2. Southern Study Area.....	3
Figure 1.1. Locations of buoys offshore of the northwest U.S. coast.....	16
Figure 1.2. Locations of buoys off the Washington coast.....	17
Figure 1.3. Locations of buoys off the Oregon/Washington coast near the Columbia River mouth.....	18
Figure 1.4. Locations of buoys off the Northern California and Southern Oregon coast.....	19
Figure 1.5. Locations of buoys off the California coast near San Francisco Bay.....	20
Figure 1.6. HF radar coverage along the California and Oregon coast.....	21
Figure 1.7. Mean sea level pressure (mbar) over the northeast Pacific during May through August 2001, from the NCEP Eta model.....	23
Figure 1.8. Mean surface wind stress vectors off the coast of Oregon and California during May-August 2001, from QuickSCAT scatterometer.....	24
Figure 1.9. Annual cycle of the wind as recorded by NDBC buoys.....	26
Figure 1.10. Kinetic energy spectra of wind measured at sensor height at Sea Ranch (Northern California coast), the data are from buoys C5 (30 km offshore), C3 (10 km offshore), and SR (0 km offshore).	28
Figure 1.11. Conceptual model of the lower atmosphere over eastern North Pacific during periods of persistent south and southeastward winds in summer.	30
Figure 1.12. Conceptual model of lower atmosphere over the nearshore zone during (top) night and (bottom) day.....	31
Figure 1.13. Surface winds at three locations across the shelf – Sea Ranch (0 km offshore), buoy C3 (10 km offshore), and buoy C5 (30 km offshore).	32
Figure 1.14. Harmonic fits to alongshore and cross-shelf components of the currents (sticks parallel to the vertical axis represent flow parallel to the principal axes of the mean flow).	35
Figure 1.15. Drifter trajectories over 30 days from deployments in April (left) and July (right).	37

Figure 1.16. Mean surface currents north of Pt. Reyes for the months of June (left) and November (right) in 2001.	39
Figure 1.17. January 1988 deployment of drifters.	40
Figure 1.18. Mean HF-radar-measured surface currents in the Gulf of the Farallones for the month of October 2006 (black arrows).	41
Figure 1.19. Observed and predicted sea level elevations as a function of latitude.	42
Figure 1.20. Long-term (1967-1991) monthly means (± 1 standard deviation) of the coastal upwelling index at lat. 45° N, long. 125° W (black, Newport) and lat. 42° N, long. 123° W (grey, Crescent City).	43
Figure 1.21. Cross section of the seasonal evolution of sea temperature over the continental shelf and slope off the coast of Washington.	44
Figure 1.22. Zonal profiles of (upper left) meridional wind stress, (lower left) wind stress curl, (upper right) upwelling velocity, and (lower right) cumulative vertical transport at: lat. 44.5° N near Newport, and lat. 42° N and lat. 41.5° N near Crescent City.	45
Figure 1.23. QuikSCAT mean July wind stress (left) and wind stress curl (right), 2002-2003. (left) Wind stress vectors and vector magnitudes (N/m^2). Every second vector of the 0.25-degree grid is shown.	46
Figure 1.24. Satellite images of sea surface temperature for July 5, 1999, and July 12, 2000.	47
Figure 1.25. Monthly upwelling index and upwelling index anomaly for Jan. 2000 - Apr. 2001.	49
Figure 1.26. Monthly upwelling index and upwelling index anomaly for Jan. 2004 - Apr. 2006.	50
Figure 1.27. NOAA CoastWatch sea surface temperature image for the California central coast for September 8, 2003.	52
Figure 1.28. Vertical profiles of temperature, salinity and density for summer (thin lines) and winter (thick lines) for inner shelf (solid lines), outer shelf (dashed lines) and slope (dotted lines) for the NSF WEST program D-Line hydrographic stations extending offshore from Bodega, CA.	53
Figure 1.29. TS diagrams for all data acquired during the WEST cruises of spring 2000, 2001, and 2002 and winter 2002 and 2003 (from top to bottom) over the slope (left column), at the outer shelf (middle column), and at the inner shelf (right column) along the D-line off Bodega, California.	54

Figure 1.30. Maps of mean monthly surface temperature in the California Current region, lat. 24° N to lat. 50° N and long. 110° W to long. 135° W.....	55
Figure 1.31. Power spectral densities from HF radar, ADCP, and wind data.	57
Figure 1.32. Variance-conserving spectra of wind stress at NDBC buoy 46022 (Eel River) (solid line), alongshore current at 10 m off Cape Mendocino (dotted line), and sea surface pressure (SSP) at the NOS tide gauge in Humboldt Bay (dashed line). ...	58
Figure 1.33. AVHRR images of sea surface temperature. (a) June 12, 1988.	59
Figure 1.34. The acceleration in subtidal, near-surface alongshore current (solid line) at 90 m moorings along the Northern California coast compared with a subtidal record of the difference in SSP between Point Reyes and Humboldt Bay (dotted line).	60
Figure 1.35. (top) Comparison of the subtidal alongshore difference in SSP between Point Reyes and Humboldt Bay (dotted line) with the subtidal alongshore difference in alongshore wind stress between buoys NDBC 46013 and 46022 (solid line). (bottom) Comparison of the difference in SSP (dotted line) with the alongshore wind stress at NDBC 46013 alone (solid line).	60
Figure 1.36. a) North-south wind forcing during July and early August 2004. The width of the black line indicates one standard deviation in wind stress over the model domain. Blue bars mark the 25-hour averages shown in (b). (b) Model surface salinity.....	63
Figure 1.37. Amplitudes of the M ₂ tidal constituent (in centimeters) derived from the FES99 model.	65
Figure 1.38. Velocity ellipses for the two barotropic shelf waves permitted for the Heceta Bank profile at the K ₁ frequency along with ellipses for the (shelf-modified) Kelvin wave (top).	66
Figure 1.39. Tidal ellipses at (a) O ₁ , (b) P ₁ , (c) K ₁ , (d) M ₂ , and (e) S ₂ frequencies. Clockwise rotation ellipses are shown in blue, and counterclockwise ellipses are in red.	68
Figure 1.40. Contours of percent tidal variance in the Gulf of the Farallones for September 2006 - August 2007.	69
Figure 1.41. Multivariate ENSO Index from 1959-1998.	70
Figure 1.42. Mean sea level pressure with surface wind vectors climatology and composite-anomaly maps for El Niño and La Niña years. Base period 1959-97.	73
Figure 1.43. (top) Anomalous climate conditions associated with warm phase PDO, and (bottom) November-March average values of the PDO Index. Values shown are °C for SST, millibars for SLP, and direction and intensity of wind stress. The longest vectors for wind stress represent a pseudostress of 10 m ² /s ¹	74

Figure 1.44. Atmospheric forcing patterns of the PDO and NPGO modulate decadal changes in coastal upwelling.	75
Figure 1.45. CDIP coastal nowcast spectral model output courtesy CDIP, Scripps Institution of Oceanography.....	77
Figure 1.46. The distribution of significant wave height, H_s , for the years 2004 to 2007 at the CDIP Point Reyes Buoy.	78
Figure 1.47. Spatial variability of wave heights in the North Pacific: A) Average yearly and winter significant wave heights and B) Average maximum wave heights.....	79
Figure 1.48. General wave directions for California based on offshore buoy data.....	80
Figure 1.49. Significant wave height wave rose for CDIP buoy 036 Grays Harbor, Washington.	81
Figure 1.50. Significant wave height wave rose for CDIP buoy 094 Cape Mendocino in Northern California.....	82
Figure 1.51. Daily average significant wave height H_s in meters (blue line) and wave power in kW/m (orange line) observed at CDIP Point Reyes buoy in 2007.....	84
Figure 1.52. Monthly variations in wave breaker heights using deepwater measurements from the CDIP Coquille, Oregon, buoy which began operation in 1981.....	85
Figure 1.53. Seasonal variation of wave energy profile for Northern California.	86
Figure 1.54. The Annual wave height residuals for the Washington and Pt. Arguello (Southern California) buoys vs. the NPI and MEI measured indices.....	87
Figure 1.55. Decadal trends in annual averages of the winter significant wave heights measured by West Coast buoys at different latitudes.	88
Figure 1.56. Annual wave power averages worldwide in kW/m wave front.....	91
Figure 1.57. Statistical wave distribution matrix and lines of constant wave power and gradient.	93
Figure 2.1. Juan de Fuca Ridge - Gorda Ridge - Axial Seamount -- showing features of Pacific/Juan de Fuca/North American subduction system relative to Western United States.	106
Figure 2.2. The Humboldt Slide complex, offshore the Eel River in Northern California.....	114
Figure 2.3. A diagram of the Cascadia Subduction Zone showing the Ocean Observatories Initiative planned systems in the Pacific Northwest.....	116

Figure 3.1. Distributions of (A) nitrate, (B) phosphate, (C) silicate, and (D) ammonium in surface waters off the coast of Oregon during February 2003, supplied by coastal rivers including the Columbia River.....	131
Figure 3.2. Vertical profiles of (A) temperature, (B) salinity, (C) nitrate, (D) silicic acid, (E) total dissolved Fe, and (F) labile dissolved Fe in the upper 300 m of the water column at a series of stations beginning offshore in the middle of the California Current (Sta. 4), in transition waters (Sta. 5), and continuing onshore into active coastal upwelling areas (Sta. 6 and 8) for a transect approximately along CalCOFI line 67.....	133
Figure 3.3. Cartoon of the processes involved in the Columbia River Plume.....	134
Figure 3.4. Table summarizing the discrete O ₂ budget.....	136
Figure 3.5. Cross-shelf distributions of calibrated (a) O ₂ and (b) particulate organic carbon (POC) concentrations for the section off Cape Perpetua, Oregon, on 28-29 May 2001, showing contoured data.....	137
Figure 3.6. Schematic representation of simplified (a) upwelling and (b) relaxation conditions. Small near-surface dots represent newly photosynthetically produced POC; larger near-bottom dots represent flocculated, ballasted POC.....	138
Figure 4.1. Monthly climatology (based on 1996–2004 time period) of biomass (dashed line) and species richness (mean 6SE).....	153
Figure 4.2. Eight day composite of SeaWiFS images, from spring 2000, showing false color surface chlorophyll concentrations.....	155
Figure 4.3. Development of surface chlorophyll α features and seasonal depth structure of chlorophyll in waters overlying the shelf regions of Washington and Oregon.....	156
Figure 7.1. Designated groundfish essential fish habitat	191
Figure 7.2. Species and life stages associated with soft and mixed hard/soft bottoms on the continental shelf.....	206
Figure 7.3. Species and life stages within the intertidal zone	209
Figure 7.4. Species and life stages associated with hard and mixed hard/soft bottoms on the continental shelf.....	210
Figure 7.5. Species and life stages associated with rooted macrophytes, algae, and seagrasses in estuarine, intertidal, and continental shelf zones.....	211
Figure 9.1. Map of the Pacific Flyway (U.S. Fish & Wildlife Service).....	238
Figure 12.1. Map showing the Olympic Coast National Marine Sanctuary.....	296

Figure 12.2. Map of Cordell Bank National Marine Sanctuary.....	297
Figure 12.3. Map of Gulf of the Farallones National Marine Sanctuary and adjacent sanctuaries.....	298
Figure 12.4. Map of Gulf of Monterey Bay National Marine Sanctuary.....	299
Figure 12.5. Areas of Special Concern in the north central areas under designation by the State of California.....	305
Figure 13.1. Location of Northwest Training Range Complex in Northern Study Area.....	323
Figure 15.1 Schematic of wave diffraction into the wave shadow behind a WEC device (or breakwater) that extracts 100 percent of the incident wave energy.....	347

[VOLUME II—SOUTHERN STUDY AREA](#)

Figure 1.1. Offshore buoys locations found in the Southern Study Area.	472
Figure 1.2. DART buoys locations around the world.	473
Figure 1.3. CDIP buoys locations in the Southern Study Area. Buoy numbers are the CDIP buoy numbers, though all buoys also have a NOAA/NDBC designation.	474
Figure 1.4. Full Southern California Coastal Ocean Observing System (SCOOS) observational data inventory.....	475
Figure 1.5. Mean sea level pressure (mb) over the northeast Pacific during May through August 2001, from the NCEP Eta model.....	477
Figure 1.6. Annual cycle of the wind.....	478
Figure 1.7. Mean monthly wind vectors over annual cycle in 1996: January (bottom arrow) through December (top arrow).	480
Figure 1.8. The Santa Barbara Channel with bathymetric relief and satellite imagery to show topography.	481
Figure 1.9. Monthly upwelling index and upwelling index anomaly for Jan. 2000 - Apr. 2002.	484
Figure 1.10. The T-S diagrams for water masses in the coastal upwelling region (0–100 km from the coast and 0–150-m depth) averaged for the period 1954–70 (black dots) and the period 1984–2000 (gray dots). (a) CalCOFI observations from.....	485
Figure 1.11. Sections of potential density, temperature and salinity along CalCOFI line 90 from the latest data report.	489

Figure 1.12. Seasonal cycle of temperature profiles in the shelf (left) and on the continental slope.....	490
Figure 1.13. IWAVES currents meter deployment array.....	494
Figure 1.14. Diagram of bathymetry (dark > 100 m) and instrument array (symbols) used in the investigation of infragravity waves.....	495
Figure 1.15. Multivariate ENSO Index from 1959-1998.....	497
Figure 1.16. Mean sea level pressure with surface wind vectors climatology and composite-anomaly maps for El Niño and La Niña years.....	499
Figure 1.17. (top) Anomalous climate conditions associated with warm phase PDO, and (bottom) November-March average values of the PDO Index.....	501
Figure 1.18. Atmospheric forcing patterns of the PDO and NPGO modulate decadal changes in coastal upwelling.	502
Figure 1.19. A comparison of the NPGO cycling with the CalCOFI salinity, nutrient and chlorophyll measurements,.....	504
Figure 1.20. CDIP coastal spectral model output got CDIP Station 067 (33 deg 13.33'N, 119 deg 53.00'W NDBC/WMO identifier 46219, approximately 15.5 nmi west of the northwest corner of San Nicholas Island,).....	507
Figure 1.21. Spatial variability of wave heights in the North Pacific: A) Average yearly and winter significant wave heights and B) Average maximum wave heights.....	508
Figure 1.22. Significant wave height wave rose for CDIP buoy 067 (33 deg 13.33'N, 119 deg 53.00'W NDBC/WMO identifier 46219, approximately 15.5 nmi west of the northwest corner of San Nicholas Island,) and CDIP buoy 111 (34 deg 10.21'N, 119 deg 26.15'W, NDBC/WMO Identifier 46217, Anacapa Passage.	510
Figure 1.23. Seasonal variability of wave climate in the North Pacific.....	513
Figure 1.24. Decadal trends in annual averages of the winter significant wave heights measured by West Coast buoys at different latitudes.	514
Figure 2.1 Elements of the California borderland.....	525
Figure 2.2. Seamounts in the Southern Study Area.	528
Figure 2.3. Sedimentation rates in the California borderland. Zone 2 has Holocene rates exceeding 30 mg/cm ² /yr.	535
Figure 2.4. Relative motion on the main trace of the San Andreas Fault system.	536

Figure 2.5. The western segment of the Goleta slide and propagating crack: (a) slope shaded EM300 multibeam bathymetry showing the western lobe of Goleta slide and adjoining area including the Gaviota slide and propagating head crack, (b) interpretations of morphologic features.....	539
Figure 2.6. Patterns of surface water turbidity following rainy season storms of January, 1978.	540
Figure 3.1. Coal Oil Point seep field distribution and underlying geologic structure oblique view from above looking northwest through transparent sea surface showing faults, Monterey Formation (MF), and seep gas spatial distribution (red strong emission, blue weak), and top of the Rincon Formation.	567
Figure 3.2. Generalized geologic cross-section of the Ventura and Santa Barbara Basins. COP is Coal Oil Point.	569
Figure 3.3. Map view of Monterey Formation depth (100 m contour lines) offshore of Coal Oil Point, Global Position Satellite survey locations of seepage (red dots) and sonar return data (red = high, blue = low); yellow line indicates outcropping; CPF is Coal Oil Point fault.	569
Figure 3.4. Schematic showing outcropping seepage mechanisms. Dashed lines are faults.	570
Figure 3.5. Map of sediment overburden and sonar-return derived map of seepage emissions.....	572
Figure 3.6. (A) Aerial photo taken June 4, 2003, showing typical seepage in the near-shore seeps off Coal Oil Point.	573
Figure 3.7. Images of Trilogy seep area: (a) aerial, (b) from boat, (c) from submarine.	574
Figure 3.8. Tar whips a few centimeters long at Jackpot seep and tar paddy.	581
Figure 3.9. Schematic of important initial oil slick evolution processes with a time scale of 1 to several days.....	582
Figure 6.1. Map showing location of the four Marine Ecosystem Response Project, MERRP, study areas surrounding the Santa Barbara Channel; Vandenberg reserve (VA), Big Sycamore State reserve (BS), North Anacapa (NA), and South San Miguel (SM).	629
Figure 12.1. Map of the marine protected areas in the Channel Island National Marine Sanctuary	745
Figure 13.1. Location of Point Mugu Sea Range in Southern Study Area.	759
Figure 16.1. Maximum tsunami amplitudes from numerical simulation of the tsunami generated by the Western segment of the Goleta slide.	779

Figure 16.2. The Goleta slide complex: a) multibeam bathymetric image showing multiple lobes, mass failures, slump blocks and scars of the Goleta slide; b) Sub components of the Goleta slide and other slides in the Santa Barbara Channel.....782

Figure 16.3. Location of major faults that direct fluid to the sea floor, that can rupture during earthquakes.783

LIST OF TABLES

VOLUME I—NORTHERN STUDY AREA

Page

Table 1.1.	Average wave power flux (wave power) from NDBC buoy measurements at California locations north of Point Conception.	92
Table 1.2.	Coquille River reference scatter diagram.	93
Table 6.1.	A Selection of Invertebrate Commercial Landings, in WA, OR, and CA. NOAA Fisheries Annual Commercial Landings Statistics 2007	181
Table 7.1.	Common and Scientific Names of Pelagic Species Generally Caught in the Northern Study Area.....	198
Table 7.2.	Common and Scientific Names of Species Included in the Pacific Groundfish FMP	199
Table 7.3.	Endangered Species Act Threatened and Endangered Fish Species in the Northern Study Area.....	202
Table 8.1.	Conservation status of all species of sea turtles found in the Northern Study Area.....	221
Table 9.1.	National Wildlife Refuges found along the Pacific Coast between Grays Harbor, WA and San Francisco Bay.....	228
Table 9.2.	Shorebird species observed within coastal habitats of Washington, Oregon, and Northern California.....	231
Table 9.3.	Seabird species that forage or breed in the Northern Study Area (NSA).....	233
Table 9.4.	Federally Threatened and Endangered Bird Species in the Northern Study Area.....	234
Table 10.1.	Marine Mammal Species Occurrence and Habitats for Northern Planning Area, Grays Harbor to San Francisco Bay.	243
Table 12.1.	National Park System Units In the Northern Study Area	300
Table 12.2.	National Wildlife Refuge System Units In the Northern Study Area	301
Table 13.1.	Population in the Coastal Region of Northern Study Area, 2000 ^a	310
Table 13.2.	Socioeconomic Environment for the Coastal Region of Northern Study Area, 1990 and 2007.....	311
Table 13.3.	Number of Establishments by Economic Sector in the Coastal Region of Northern Study Area, 2007.....	313
Table 13.4.	Minority Populations in the Coastal Region of Northern Study Area, 2007 ^a	316

Table 13.5. Low-Income Populations in the Coastal Region of Northern Study Area, 2007	317
Table 13.6. Cargo Volume by Port in the Coastal Region of Northern Study Area, 2007 (except where noted).....	318
Table 13.7. Port Calls by Port and Commercial Vessel Type in the Coastal Region of Northern Study Area, 2007.....	319
Table 13.8. Economic Impacts of Travel in the Coastal Region of Northern Study Area (\$millions), 2007.....	320
Table 13.9. Employment and Wages in Ocean-Related Tourism and Recreation Sector in the Coastal Region of Northern Study Area, 2003.....	321
Table 13.10. Major Commercial Fishing Ports in California Statistical Areas in Northern Study Area, 2007.....	325
Table 15.1. Energy production during trials for WEC devices deployed off Oregon, with incident energy flux of 21.2 kW/m.....	346
Table 15.2. Reduction in longshore sediment flux corresponding to decreases in wave breaker height, calculated with different published relationships.....	349
Table 22.1. Sound Pressure Levels from Underwater Noise Sources.....	389

VOLUME II—SOUTHERN STUDY AREA

Table 1.1. Wave height and period scatter table for the Southern California Bight. From Beyene and Wilson 2006.....	511
Table 1.2. Predictability of wave heights by location. Wave heights can be used as a proxy for wave energy. The Southern California Bight shows much less variance both for particular months and over the annual cycle compared to Bodega Bay, Santa Marine and Hawaii.	511
Table 7.1. Conservation status of all species of fish found in the Southern Study Area (CA DFG 2009).....	648
Table 8.1. Conservation status of all species of sea turtles found in the Southern Study Area.....	669
Table 9.1. Conservation status of all species of birds found in the Southern Study Area.....	686
Table 10.1. Marine mammal species for the Southern Study Area.....	693
Table 13.1. Socioeconomic Environment for the Coastal Region of Southern Study Area (millions), 1990 and 2007.....	751

Table 13.2. Number of Establishments by Economic Sector in the Coastal Region of Southern Study Area, 2007.....	752
Table 13.3. Minority Populations in the Coastal Region of Southern Study Area, 2007 ^a	754
Table 13.4. Low-income Populations in the Coastal Region of Southern Study Area, 2007.....	755
Table 13.5. Cargo Volume by Port in the Coastal Region of Southern Study Area, 2007.....	756
Table 13.6. Port Calls by Port and Commercial Vessel Type in the Coastal Region of Southern Study Area, 2007.....	756
Table 13.7. Economic Impacts of Travel in the Coastal Region of Southern Study Area (millions), 2007.....	757
Table 13.8. Employment and Wages in Ocean-Related Tourism and Recreation Sector in the Coastal Region of Southern Study Area, 2003.....	758
Table 13.9. Major Commercial Fishing Ports in California Statistical Areas in Southern Study Area, 2007.....	760
Table 17.1. Platforms Discharging Produced Waters in Southern California.....	800
Table 22.1. Sound Pressure Levels from Underwater Noise Sources.....	856
Table 24.1. Cetacean Species With Potential Susceptibility to Seismic Surveys in the Southern Study Area.....	879
Table 24.2. Potential Susceptibility of Pinniped Species and Sea Otters to Seismic Surveys in the Southern Study Area.....	880

ACRONYMS AND ABBREVIATIONS

μPa	micropascal
4H	oil platforms Heidi, Hilda, Hazel, and Hope
AC	alternating current
ADCP	acoustic Doppler current profiler
APD	average wave period
ATMP	air temperature
AUV	autonomous underwater vehicle
AVHRR	advanced very high resolution radiometer
AWOIS	Automated Wreck and Obstruction Information System
BBL	benthic boundary layer
BETX	benzene, toluene, ethylbenzene, and xylene
BLM	Bureau of Land Management
BOEMRE	Bureau of Ocean Energy Management, Regulation and Enforcement
C	carbon
c	wave speed
CalCOFI	California Cooperative Oceanic Fisheries Investigations
CC	California Current
CCD	carbonate compensation depth
CCS	California Current System
CCW	counterclockwise
CDIP	Coastal Data Information Program
CenCOOS	Central and Northern California Coastal Observing System
CHILL	wind chill
CINMS	Channel Islands National Marine Sanctuary
cm	centimeter
COADS	Comprehensive Ocean-Atmosphere Data Set
COAMPS	Coupled Ocean-Atmosphere Mesoscale Prediction System
CODE	Coastal Ocean Dynamics Experiment
COP	Coal Oil Point
cpd	cycles per day
cph	cycles per hour
CSZ	Cascadia Subduction Zone
CTD	current temperature density
CU	California Undercurrent
DAHP	Department of Archaeology and Historic Preservation
DART	Deep-ocean Assessment and Reporting of Tsunamis

dB	decibels
DBT	dibutyltin
DC	direct current
DDE	dichlorodiphenyldichloroethylene
DDT	Dichlorodiphenyltrichloroethane, C ₁₄ H ₉ C ₁₅
DEA	data envelopment analysis
DIR	dissimilatory iron reduction
DOC	dissolved organic carbon
DOE	U.S. Department of Energy
DOM	dissolved organic matter
DON	dissolved organic nitrogen
DPD	dominant wave period
DPS	distinct population segments
EEZ	exclusive economic zone
EFH	essential fish habitat
EKE	eddy kinetic energy
EMF	electromagnetic field
ENSO	El Niño Southern Oscillation
EOF	empirical orthogonal function
EPA	United States Environmental Protection Agency
ESA	Endangered Species Act
ESP	electrical service platform
ESU	evolutionary significant units
F	bubble size distribution
FERC	Federal Energy Regulatory Commission
FMP	Fishery Management Plans
FT-ICR-MS	Fourier transform ion cyclotron resonance mass spectrometry
FWS	United States Fish and Wildlife Service
<i>g</i>	gravity
GC×GC-ToF-MS	comprehensive two-dimensional gas chromatography–time of flight mass spectrometry
GFS	Global Forecast System
GIS	Geographic Information System
GLOBEC	GLOBAL Ocean Ecosystems Dynamics North East Pacific
GST	wind gust
<i>h</i>	water depth
H ₂ S	hydrogen sulfide
HABS	harmful algal blooms
HAPC	Habitat Areas of Particular Concern

HF Radar	high frequency radar
HNLC	high-nutrient-low-chlorophyll
H_t	significant wave height
Hz	hertz
I	turbulence intensity
IC	inshore current
ICP	inductively coupled plasma
ICP-MC-MS	inductively coupled plasma multi-collector mass spectrometry
IUCN	International Union for the Conservation of Nature
IWAVES	internal waves on the continental margin
ka	thousands of years
kcal	kilocalories
LOEC	lowest observed effect concentration
LOLA	lots of lousy algebra
m	meters
M	magnitude [earthquake]
Ma	millions of years
MABL	marine atmospheric boundary layer
MAG-PLAN	MMS Alaska-Gulf of Mexico Modeling using IMPLAN
mbar	millibar
MBARI	Monterey Bay Aquarium Research Institute
MBT	monobutyltin
MEI	Multivariate ENSO Oscillation
MF	Monterey Formation
MFZ	Mendocino Fault Zone
mg	milligram
mg/L	milligrams per liter
MHK	marine and hydrokinetic
MJO	Madden Julian Oscillation
MM5	PSU/NCAR Mesoscale Model
MMPA	Marine Mammal Protection Act
MMS	Minerals Management Service
MODIS	Moderate Resolution Imaging Spectroradiometer
MPA	Marine Protected Area
MRFSS	Marine Recreational Fisheries Statistics Survey
mT	metric ton
MTJ	Mendocino Triple Junction
N	north latitude
NAM	North American Mesoscale
NCDC	NOAA National Climatic Data Center

NCEP	NOAA National Center for Environmental Prediction
NDBC	NOAA National Data Buoy Center
NEP	National Estuarine Program
NEPA	National Environmental Policy Act
NERR	National Estuarine Research Reserve
NERRS	National Estuarine Research Reserve System
NHPA	National Historic Preservation Act
NMFS	NOAA National Marine Fisheries Service
NMR	nuclear magnetic resonance
NOAA	National Oceanic and Atmospheric Administration
NODC	NOAA National Ocean Data Center
NOGAPS	Navy Operational Global Atmospheric Prediction System
NOS	NOAA National Ocean Service
NPDES	National Pollutant Discharge Elimination System
NPGO	North Pacific Gyre Oscillation
NPI	North Pacific Index
NRC	National Research Council
NWR	National Wildlife Refuge
NWS	NOAA National Weather Service
OCS	Outer Continental Shelf
OHP	Office of Historic Preservation
PacFIN	Pacific Fisheries Information Network
PAH	polycyclic aromatic hydrocarbon
PBDE	polybrominated diphenyl ether
PCA	principal component analysis
PCB	polychlorinated biphenyl
PCW	Pacific Central Water
PDO	Pacific Decadal Oscillation
PEW	Pacific Subequatorial Water
PFD	personal flotation device
PFMC	Pacific Fishery Management Council
PG&E	Pacific Gas & Electric
PIER	Public Interest Energy Group
PNA	Pacific-North America
POC	particulate organic carbon
POM	particulate organic matter
POTWs	publicly owned treatment works
PRES	atmospheric pressure
PSMFC	Pacific States Marine Fisheries Commission
PSP	paralytic shellfish poisoning

PSS	Practical salinity scale
PSW	Pacific Subarctic Water
PTDY	[atmospheric] pressure tendency
Q	capillary tube flow
RecFIN	Recreational Fisheries Information Network
ROG	reactive organic gas
ROMS	Regional Ocean Modeling System
ROV	remotely operated vehicle
SAF	San Andreas Fault
SCB	Southern California Bight
SCCS	Southern California Current System
SCCWRP	Southern California Coastal Water Research Project
SCE	Southern California Eddy
SCOOS	Southern California Coastal Observing System
SeaWiFS	sea-viewing wide field-of-view sensor
SHPO	State historic preservation officer
Si	silicon
SIO	UC San Diego Scripps Institution of Oceanography
SLP	sea level pressure
Sn	tin
SOI	Southern Oscillation Index
spp.	species
SR	Sea Ranch
SSEC	Space Science and Engineering Center
SSH	sea surface height
SSHa	sea surface height anomaly
SSS	sea surface salinity
SSSa	sea surface salinity anomaly
SST	sea surface temperature
SSTa	sea surface temperature anomaly
STEEPNESS	wave steepness
SWAN	simulating waves near-shore
SwD	swell direction
SwH	swell height
SwP	swell period
TBT	tributyltin
TWC	treatment, workover, and completion
USCG	United States Coast Guard
VLF	very low frequency
VOC	volatile organic carbon

V_{up}	bubble plume upwelling flow rate
W	west longitude
WDIR	wind direction
WEC	wave-energy-capturing
WSPD	wind speed
WTMP	water temperature
WW III	Wave Watch III
WWH	wind wave height
WWP	wind wave period
WXMAP	Gobal & Regional Weather Prediction Charts
yr	year

A. INTRODUCTION

A.1 BACKGROUND OF THE STUDY

The Bureau of Ocean Energy Management, Regulation, and Enforcement (BOEMRE) of the U.S. Department of the Interior (Department), formerly the Minerals Management Service, has jurisdiction over leasing and development of Outer Continental Shelf (OCS) submerged lands for mineral development. The BOEMRE Pacific OCS Region is a significant source of oil and gas for the nation. To perform periodic and project reviews of oil and gas production activities on existing leases in California, the BOEMRE Pacific Region has relied on environmental documentation prepared for previous lease sales, platform and pipeline construction, undeveloped leases, and other documents and reports. The basis for much of this documentation comes from a summary of knowledge prepared for the predecessor agency MMS in 1993, covering available information for key environmental topics through 1992. The BOEMRE needs to update this summary of knowledge to include information for subjects where significant new information has become available since 1992.

The Energy Policy Act of 2005 amended Section 8 of the OCS Lands Act (OCSLA) (43 USC 1337) to give the Secretary of the Interior authority to issue a lease, easement, or right-of-way on the OCS for activities that are not otherwise authorized by the OCSLA, including activities that produce or support production, transportation, or transmission of energy from sources other than oil and gas. This includes wind, wave, and current technologies. The BOEMRE Pacific Region prepared a previous summary of knowledge for areas beyond existing leases in Southern California in 1977. The BOEMRE needs to update its summary of knowledge for areas of the OCS suitable for the development of alternative energy. This would include significant new information for the Pacific Coast from Grays Harbor, Washington to San Francisco Bay, California.

A.2 STUDY AREA (MAPS)

The two study areas for this project are depicted in the maps below ([Figures A.1](#) and [A.2](#)). The Northern Study Area reaches from Grays Harbor, Washington to San Francisco Bay, California. The principal focus is on resources within areas of OCS suitable for development of alternative energy, generally within 50 miles of the coastline. The Southern Study Area reaches from northern Santa Barbara County, California, to the Mexican border.

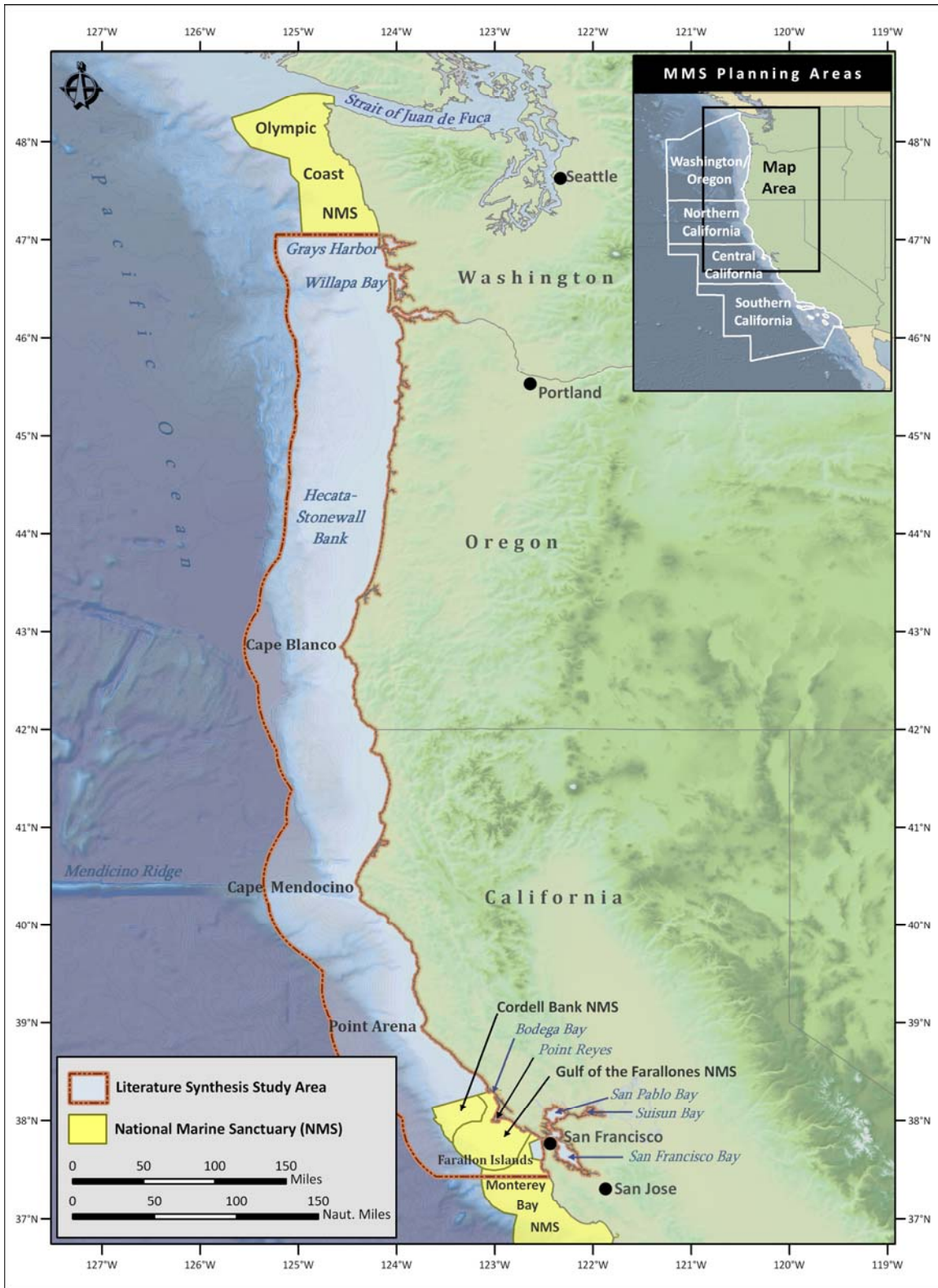

Figure A.1. Northern Study Area

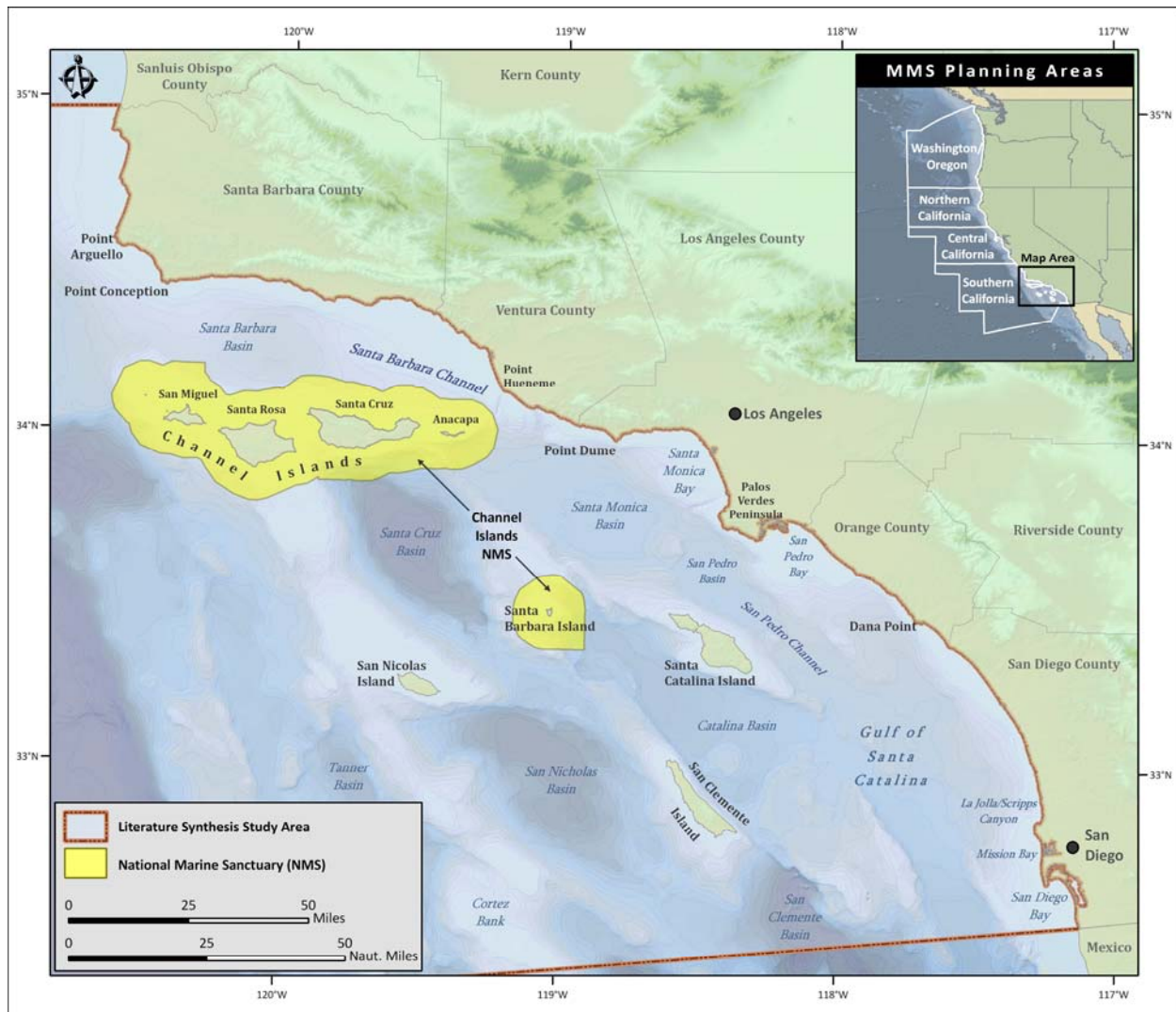

Figure A.2. Southern Study Area

A.3 STUDY OBJECTIVES

The objectives of this study are: (1) to collect, review and compile information after 1994 for the coastal and marine environment of the Southern Study Area; (2) to collect, review and compile information after 1977 for the coastal and marine environment of the Northern Study Area; (3) provide BOEMRE with a system that allows easy electronic access and retrieval of all environmental information collected during the study; and (4) to identify relevant data gaps in the current state of knowledge of the study area.

Specific objectives are to develop: (1) a computer-searchable reference database (annotated bibliography) incorporating existing literature, relevant data, and ongoing research pertaining to the geological, physical, chemical, and biological processes of the study areas, as well as to social and economic data and literature and (2) a synthesis report that characterizes the study areas and the scope and depth of information available in the different disciplines. The

information “should focus on specific topics appropriate for environmental reviews or assessments of the existing or potential activities that may occur on the OCS within the purview of MMS” (USDOJ MMS 2009).

A.4 STUDY METHODS

A.4.1 Research Plan

A research plan was developed for the project that focused on topics, issues, impacts, and regions that are most relevant to the BOEMRE’s objectives for the two study areas, as described above.

The research plan consisted of the following for each discipline:

- (1) A topic outline that set out the broad parameters of research. The outline includes a subset of topics within the broader areas of each discipline for which there are extensive and well-developed resources in the scientific literature. The subset chosen for inclusion was guided by the project focus of renewable/alternative energy development with emphasis on wind energy, wave energy, and tidal kinetic (current) energy in the Northern Study Area, and oil and gas development in the Southern Study Area.
- (2) A set of research questions for each discipline which the literature search will attempt to answer, or at least explore. To facilitate a manageable process for gathering and organizing information in support of the synthesis, the paradigm of the Environmental Impact Statement was adopted, wherein impact-producing factors are identified and their impacts on environmental resources in the study areas was researched and analyzed. This paradigm further guided the structure of the report.
- (3) A data collection strategy for the project overall, which will include a list of databases, key search terms, and other likely sources, contacts or requests for information. Guided by the research questions posed previously, this strategy provided a methodical approach for conducting the search.

The fundamental research questions driving the Pacific Updated Summary of Knowledge project are the following:

1. *What are the relevant descriptors of those human and natural systems that could be impacted by the development of renewable and alternative energy reserves in the Northern California, Oregon, and Washington Planning Areas of the U.S. OCS (Northern Study Area)?*
2. *What are the relevant descriptors of those human and natural systems that could be impacted by the continued development and operation of existing oil and gas leases in the Southern California Planning Area of the U.S. OCS (Southern Study Area)?*

A.4.2 Literature Search

A comprehensive literature search was completed, organized by oceanographic discipline, to identify relevant existing information on resources in the study area and the potential impacts of offshore alternative energy development. Specialists in each discipline developed search strategies that encompassed commercial and government databases, internet sources, and direct contacts with individuals and institutions with involvement in, knowledge of, or special access to relevant information.

The first step of the search involved online commercial and government databases. The databases included below provide the ability to search dissertations, scientific proceedings, government reports, and academic papers. The search specifically included the following databases:

- AGU
- American FactFinder
- BioOne
- BIOSIS (BasicBIOSIS)
- Bureau of the Census
- Bureau of Labor Statistics
- DOE Information Bridge
- FedStats
- GeoBase
- Geochimica et Cosmochimica Acta
- GeoRef
- Google Scholar
- Index to Scientific and Technical Proceedings (ISTP)
- Ingenta
- JSTOR
- National Sea Grant Library Database
- Science Citation Index (SCI)
- Science Direct
- U.S. Geological Survey (USGS) Publications Warehouse
- usSEABED
- Web of Science (ISI Science Citation Index)
- Web of Knowledge (ISI Citation Index)
- Southern California Coastal Water

In addition to the search of commercial databases, academic, research, and other institutions were contacted to gain access to information not available through our electronic searches, or to pursue specific lines of inquiry. These institutions included:

- Bodega Marine Laboratory
- Integrated Ocean Observing System Regional Associations:
 - NANOOS
 - PACOOS
 - CeNCOOS
- SCOOS
- Monterey Bay Aquarium Research Institute
- National Oceanic and Atmospheric Administration

-
- National Marine Mammal Laboratory
 - National Marine Sanctuaries (Channel Islands, Monterey Bay, Gulf of the Farallones, Cordell Bank, Olympic Coast)
 - Northwest Fisheries Science Center
 - Southwest Fisheries Science Center
 - Oregon State University, College of Oceanic and Atmospheric Sciences and Hatfield Marine Science Center
 - Oregon Wave Energy Trust
 - Pacific Northwest National Laboratory
 - San Diego State University
 - San Francisco State University, Romburg Tiburon Center for Environmental Studies
 - University of California Santa Barbara
 - University of San Diego, Scripps Institute of Oceanography
 - University of Washington, College of Ocean and Fisheries Science and Friday Harbor Laboratories

Additional steps in the literature search process included:

- Various compendia for biological stock assessments and population information were consulted.
- Internet sites of the major Federal and State government agencies that are responsible for marine biological resources were consulted. These included DOE, EPA, FERC, BOEMRE, NMFS, NOAA, USACE, USFWS, USGS, Pacific Fisheries Management Council, and State agencies in California (CalCOFI, CalEPA, Cal Fish&Game, CalOCEAN, CA Lands Commission, CERES, County of Santa Barbara Energy Commission, etc.), Oregon (ORDEQ, ORDFW, etc.) and Washington (WADNR, WADoE, WDFW).

Finally, a broad internet search was conducted using search terms similar to the online database searches. The search terms were developed for geographic and topic relevance. The literature search was refined to focus on literature for the resources and impacts most relevant to the development of energy for each study area. Topic keywords were specific to each discipline, and numbered in the hundreds overall.

A.4.3 Annotated Bibliography

All references were compiled in an electronic annotated bibliography using EndNote reference software. The records were organized into separate volumes within the master database for each of the six oceanographic disciplines. Records in the database can be searched by standard fields in the reference database (author, title, date, publisher, journal, keywords, etc), and also by two additional custom fields created for this study: habitat type and geographic region. In addition, complete PDF files were attached to the appropriate record, where such files were available and permissions were granted, either directly to project authors or through BOEMRE's Department of Interior Library.

A.5 STRUCTURE OF THE REPORT

The report is organized into two volumes: Volume I covers the Northern Study Area; Volume II covers the Southern Study Area. Each volume has two major parts: Part I includes the characterization of ecological resources and processes of the study area, broken down into chapters corresponding to the oceanographic disciplines; Part II contains the discussion of the literature on environmental impacts of the relevant energy development on these resources, focusing on alternative energy development in the Northern Study Area and oil and gas development in the Southern Study Area. Each volume concludes with a Summary of Data Gaps and Research Needs.

The report structure is as follows:

Chapter Number	Chapter Title
A	<i>Introduction</i>
	Volume I—Northern Study Area
	<i>Part I—Resources</i>
1	Physical Oceanography
2	Geological Oceanography
3	Chemical Oceanography and Geochemistry
4	Phytoplankton, Zooplankton, and Pelagic Invertebrates
5	Macrophytes
6	Benthos
7	Fish
8	Sea Turtles
9	Birds
10	Marine Mammals
11	Ecosystem Interrelationships
12	Areas of Special Concern
13	Socioeconomic Resources
14	Summary of Natural Resources
	<i>Part II—Impacts</i>
15	Physical Oceanography
16	Geological Oceanography
17	Chemical and Geochemical Oceanography
18	Phytoplankton, Zooplankton, and Pelagic Invertebrates
19	Macrophytes
20	Benthos
21	Fish
22	Sea Turtles
23	Birds
24	Marine Mammals
25	Ecosystem Interrelationships
26	Areas of Special Concern
27	Socioeconomic Impacts
28	Summary of Impacts
29	Summary of Data Gaps & Research Needs

Chapter Number	Chapter Title
	Volume II—Southern Study Area
	<i>Part I--Resources</i>
1	Physical Oceanography
2	Geological Oceanography
3	Chemical Oceanography and Geochemical
4	Phytoplankton, Zooplankton, and Pelagic Invertebrates
5	Macrophytes
6	Benthos
7	Fish
8	Sea Turtles
9	Birds
10	Marine Mammals
11	Ecosystem Interrelationships
12	Areas of Special Concern
13	Socioeconomic Resources
14	Summary of Natural Resources
	<i>Part II—Impacts</i>
15	Physical Oceanography
16	Geological Oceanography
17	Chemical and Geochemical Oceanography
18	Phytoplankton, Zooplankton, and Pelagic Invertebrates
19	Macrophytes
20	Benthos
21	Fish
22	Sea Turtles
23	Birds
24	Marine Mammals
25	Ecosystem Interrelationships
26	Areas of Special Concern
27	Socioeconomic Impacts
28	Summary of Oil and Gas Impacts
29	Summary of Data Gaps & Research Needs

Literature Cited: US DOI MMS 2008. Statement of Work: Updated summary of knowledge: Selected areas of the Pacific Coast. 32pp.

VOLUME I—NORTHERN STUDY AREA

PART I—NORTHERN STUDY AREA: RESOURCES

1. PHYSICAL OCEANOGRAPHY

The California Current System (CCS) is comprised of the three main currents off the Northern Study Area: the California Current, the Davidson Current and the California Undercurrent. Studies have shown that these three currents cannot completely describe the complexity of the structure and timing of the CCS. Mechanisms that affect the currents include wind-forcing, sea surface pressure gradients, buoyancy flows, inertial flow, eddy fields and tidal forcing. Winds along the California coast are mostly affected by the North Pacific High, while winds along the Washington coast are mostly affected by the Aleutian Low. Temporal variability in the winds is influenced by timescales ranging from hourly to decadal. The wind patterns can be divided into two seasons: the spring/summer season and the fall/winter season. Winds generate waves within the Northern Study Area, both locally and from powerful storms located in distant regions of the Pacific. Tidal currents are responsible for a significant percentage of the total currents (tidal variance) off the Northern Study Area. Buoyancy flows, flows characteristic of fresh or low-salinity outflow from bays or rivers, can have a significant effect on surface circulation and nutrient transport. Buoyancy flows from the Columbia River (also called the Columbia River Plume) in combination with wind-forcing have been observed to flow north along the Washington coast and southwest (offshore) from the Oregon coast.

This chapter discusses important data sources ([section 1.1](#)); the different temporal variations in winds, currents and water properties ([sections 1.2 to 1.5](#)); and the wave climate ([section 1.6](#)). Finally, it provides a summary and future research discussion ([section 1.7](#)). The temporal scales discussed are seasonal ([section 1.2](#)), subtidal ([section 1.3](#)), tidal and supratidal ([section 1.4](#)), and interannual ([section 1.5](#)).

1.1 DATA SOURCES AND ANALYSES

The National Data Buoy Center (NDBC, <http://www.ndbc.noaa.gov>) has about 30 NOAA buoys plus many submitted data for buoys deployed off the West Coast of the United States. The buoys are stationed over the ocean basin ([Figure 1.1](#)) and along the coast of the Northern Study Area ([Figures 1.2 through 1.5](#)). The maps below show NDBC-hosted buoy locations along with locations of buoys maintained by other institutions such as UC San Diego, Scripps Institution of Oceanography (SIO) (SIO is a partner in Coastal Data Information Program (CDIP) and posts the data), National Ocean Service (NOS), Monterey Bay Aquarium Research Institute (MBARI), National Estuarine Research Reserve System (NERRS), and Environment Canada. Archived and current oceanographic and meteorological data collected from the buoys are available on the NDBC website. These data include: wind direction, wind speed, wind gust, wave height, dominant wave period, average period, atmospheric pressure, pressure tendency, air temperature, water temperature, wind chill, significant wave height, swell height, swell period, wind wave height, wind wave period, wave steepness, average wave period, and swell direction.

The Coastal Data Information Program (CDIP, <http://cdip.ucsd.edu>), maintained by SIO, measures, analyzes, archives, and disseminates coastal environment data. CDIP operates and maintains about 80 buoys off the West Coast. There are two types of CDIP buoys that record wave data (directional wave data and nondirectional wave data) and one type of buoy that records meteorological and oceanographic data. CDIP provides coastal wave model outputs as

well as wave energy spectral plots. The locations of CDIP buoys are included in [Figures 1.1 through 1.5](#) although the buoy numbers are those assigned by the NDBC and don't correspond to the buoy numbers assigned by CDIP. More information on waves in the Northern Study Area is available in [Section 1.6, Wave Climate](#).

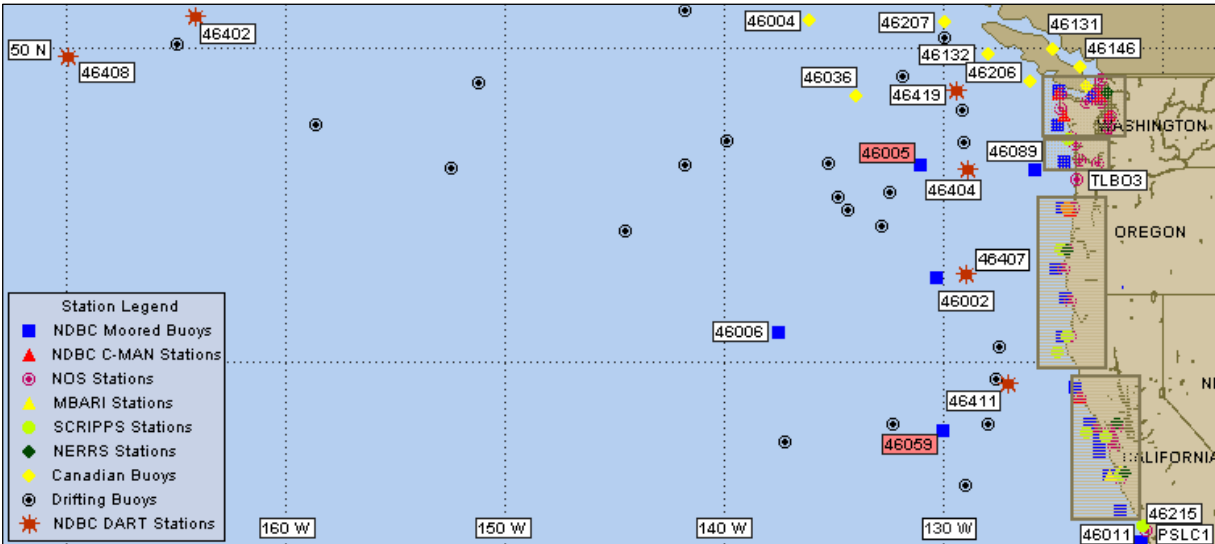

Figure 1.1. Locations of buoys offshore of the northwest U.S. coast.

From <http://www.ndbc.noaa.gov>.

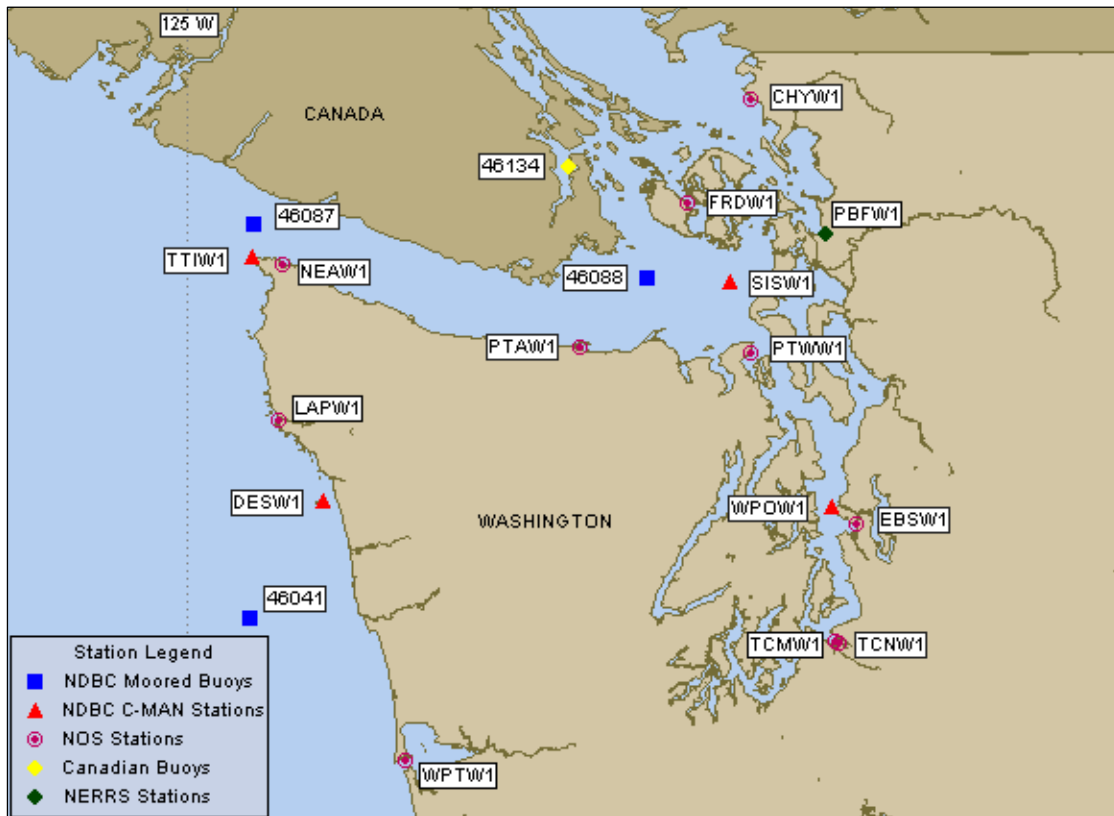

Figure 1.2. Locations of buoys off the Washington coast.

From <http://www.ndbc.noaa.gov>.

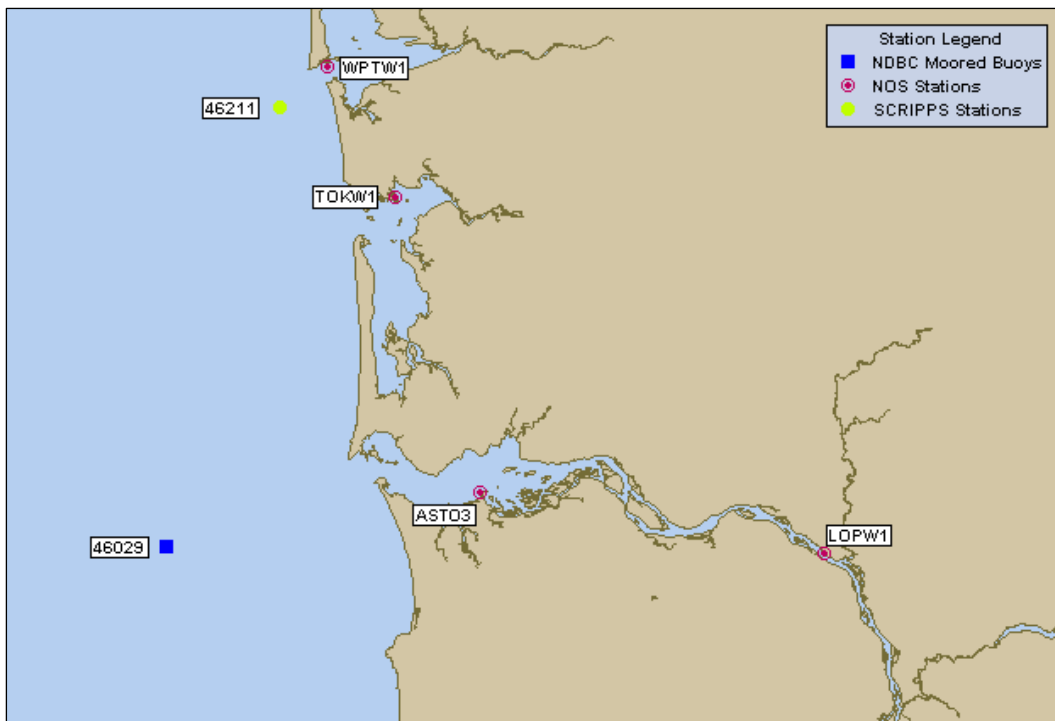

Figure 1.3. Locations of buoys off the Oregon/Washington coast near the Columbia River mouth.

From <http://www.ndbc.noaa.gov>.

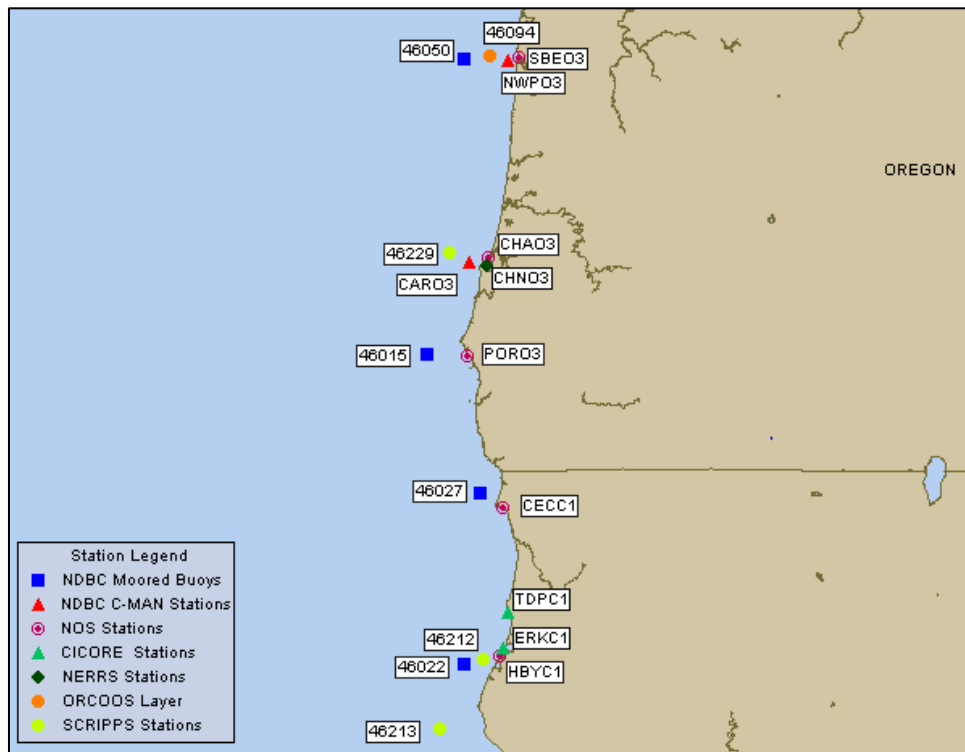

Figure 1.4. Locations of buoys off the Northern California and Southern Oregon coast.

From <http://www.ndbc.noaa.gov>.

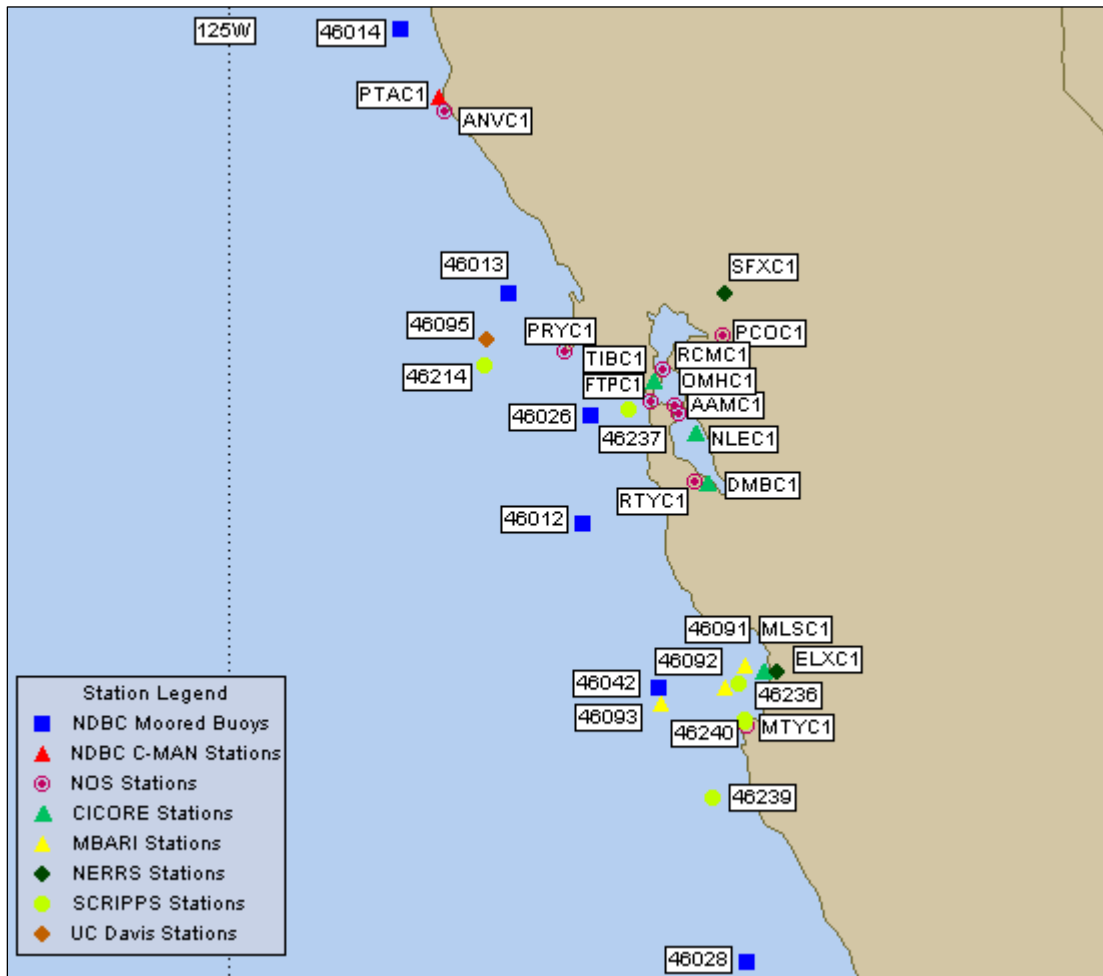

Figure 1.5. Locations of buoys off the California coast near San Francisco Bay. From <http://www.ndbc.noaa.gov>.

The NOAA National Weather Service (NWS, <http://www.ndbc.noaa.gov>) provides up-to-date, as well as archived, meteorological information, data and reports for NDBC buoys. There are numerous stations all along the coast.

The NOAA National Climatic Data Center (NCDC, <http://www.ncdc.noaa.gov/oa/ncdc.html>) provides recent and archived climatic data as well as background information and up-to-date reports on the state of the climate for all regions of the world. This includes the current state of climatic oscillations such as the El Niño Southern Oscillation (ENSO), Pacific Decadal Oscillation (PDO), and Madden Julian Oscillation (MJO) and climatic indices such as the Multivariate ENSO Index (MEI), Southern Oscillation Index (SOI), and North Pacific Index (NPI).

High frequency (HF) radar stations currently measure 3-km resolution hourly surface currents along the California and Oregon coast ([Figure 1.6](#)). Up-to-date HF radar plots and archived data are provided by NDBC (<http://hfradar.ndbc.noaa.gov>), CeNCOOS (Central and Northern California Ocean Observing System,

http://www.cencoos.org/sections/conditions/Google_currents), and SCCOOS (Southern California Coastal Ocean Observing System <http://www.sccoos.org/data/hfrnet/>).

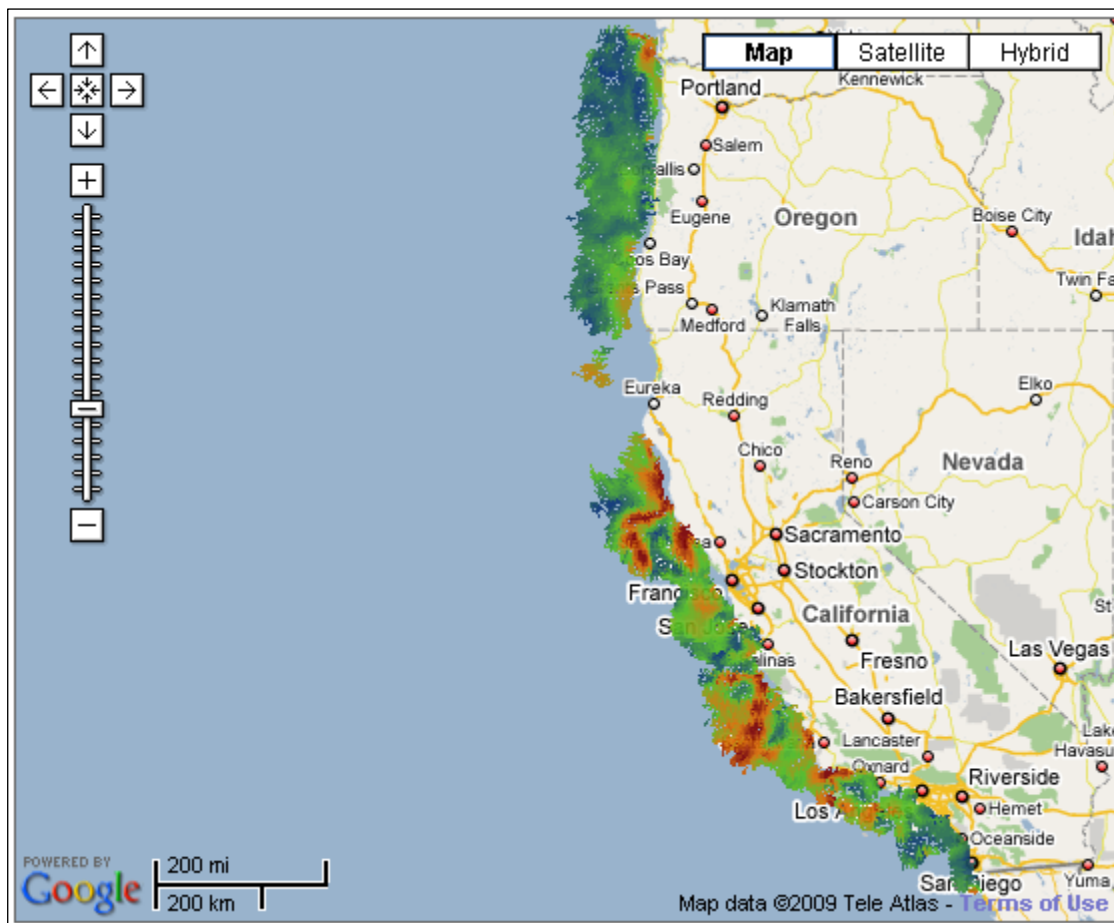

Figure 1.6. HF radar coverage along the California and Oregon coast.

From CeNCOOS, http://www.cencoos.org/sections/conditions/Google_currents.

There are a number of satellite imagery resources available. Lists of resources are provided by NOAA NCDC at <http://www.ncdc.noaa.gov/oa/climate/climateresourcesother.html#sat>, the Space Science and Engineering Center (SSEC) at <http://www.ssec.wisc.edu/data/index.html>, and the U.S. Navy at http://www.nrlmry.navy.mil/sat_products.html. The following satellite imagery are available: visible and near infrared imagery, sea surface temperature from infrared AVHRR instruments, water vapor, surface winds determined from satellite scatterometer instruments, sea surface level from altimeters and estimates of surface chlorophyll concentration determined from the SeaWiFS and MODIS visible instruments. Synthetic Aperture Radar (SAR) has potential application for both wind and wave measurements. The main problems with SAR data are that coverage is only once every two days and the satellite must be programmed for target areas.

The two most widely used numerical weather forecasting models in the United States are the North American Mesoscale (NAM) and Global Forecast System (GFS). These three-

dimensional models assimilate atmospheric data to generate surface and upper-atmospheric weather forecast maps of parameters such as pressure, wind, temperature, humidity, precipitation, vorticity, and divergence. Outputs of current and archived model runs are available from the National Center for Environmental Protection (NCEP, <http://www.nco.ncep.noaa.gov/pmb/nwprod/analysis>), which is part of NOAA, and from the University of Washington Atmospheric Science Department (<http://www.atmos.washington.edu/mm5rt>). Another popular mesoscale atmospheric model is the Pennsylvania State University/ National Center for Atmospheric Research mesoscale model known as MM5 (<http://www.mmm.ucar.edu/mm5/>). The U.S. Navy produces two products, the low-resolution global wind product NOGAPS or WXMAP and the regional high resolution model COAMPS. These wind products are available at the Fleet Numerical website <http://www.nrlmry.navy.mil>.

Wave Watch III (WW III) wave model outputs are available to the public through the U.S. Navy (<https://www.fnmoc.navy.mil/public>) and NOAA (<http://polar.ncep.noaa.gov>). These model outputs provide information on significant wave height, swell wave height, wind wave height, peak wave period, secondary wave period, swell wave period, wind wave period, and whitecap probability. LOLA is a coastal wave model available through the popular surfing website www.surfline.com. Two wave models that are used by the scientific community are the Simulating Waves Near-shore (SWAN) model and the Delft3D-WAVE model.

1.2 SEASONAL PATTERNS

1.2.1 Winds

Surface winds are driven by the surface atmospheric pressure field. Along the northwest coast of the United States, large-scale wind patterns are primarily driven by three persistent large-scale features in the surface pressure field: the North Pacific High, the Aleutian Low, and the Thermal Low. The North Pacific High is a climatological mean surface high pressure pattern that is typically situated over the eastern North Pacific and drives the winds southward along the Northern Study Area. The Aleutian Low is a mean surface low pressure pattern that is typically situated over the Gulf of Alaska and drives the winds northward along the northern regions of the Northern Study Area. The Thermal Low is a mean surface low pressure pattern caused by local surface heating in the southwest United States; it assists the North Pacific High in driving winds southward along the coast. An example of these three pressure systems and surface pressure during the spring/summer can be seen in [Figure 1.7](#) and the resulting wind stress (approximately the square of the wind speed since the effect of the wind on the water changes with the square of the wind, not as a linear relationship) in [Figure 1.8](#). Note that these are mean pressure fields; they do not necessarily represent the atmosphere at any particular point in time as the atmosphere is very dynamic and constantly changing. For example, the calculated mean of the pressure field of the Aleutian Low is largely influenced by repeated low pressure cyclonic systems propagating across the Gulf of Alaska. There is significant annual (or decadal) variability in the strength and position of these pressure fields. Climatic oscillations such as the PDO and ENSO can significantly alter the mean pressure and wind fields.

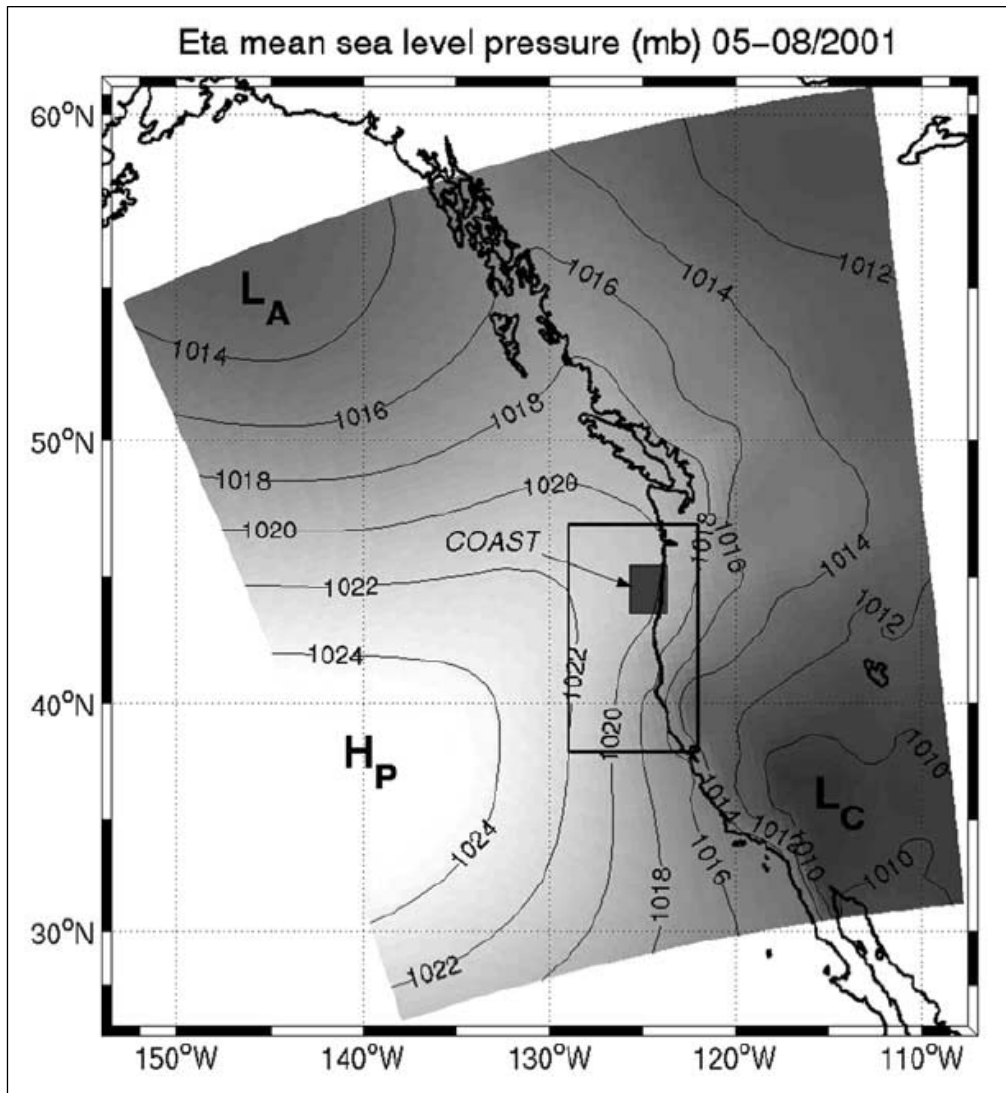

Figure 1.7. Mean sea level pressure (mbar) over the northeast Pacific during May through August 2001, from the NCEP Eta model.

The North Pacific High = H_p , the Thermal Low = L_c , and the Aleutian Low = L_A . The large rectangle shows the region pictured in Figure 1.8. and the small dark rectangle shows the NSF-funded Coastal Ocean Advances in Shelf Transport COAST study region.

From Bane et al. (2005).

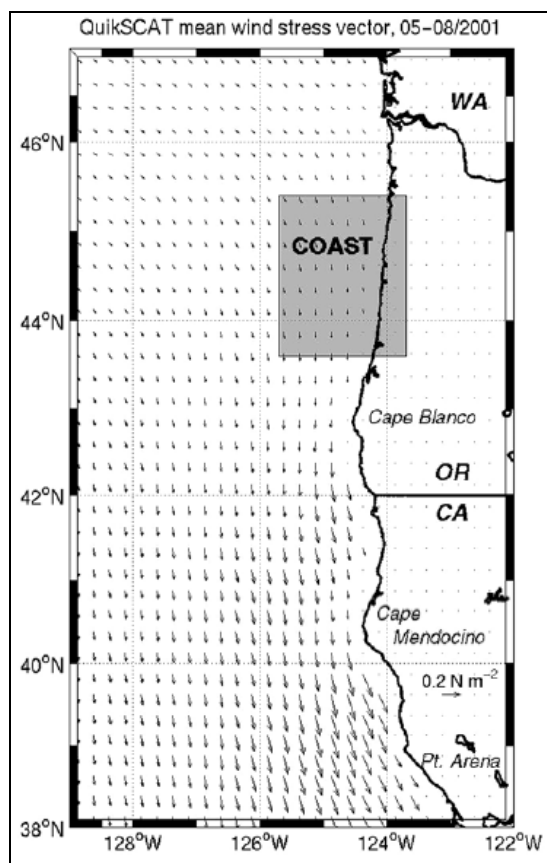

Figure 1.8. Mean surface wind stress vectors off the coast of Oregon and California during May-August 2001, from QuikSCAT scatterometer.

From Bane et al. (2005).

The wind patterns along Northern Study Area can be divided into two general seasons, the spring/summer season and the fall/winter season. During the spring/summer season the North Pacific High and Thermal Low dominate the surface pressure field and drive strong mean southward winds along the Northern Study Area. During the fall/winter season the North Pacific High weakens, the southward flow off Oregon and California weakens, and the Aleutian Low strengthens, driving northward winds off the Washington coast.

In this document the seasons will be divided into the spring/summer and fall/winter seasons, although at times this approach over generalizes the seasons. In particular, the wind regimes between fall and winter can be quite different. Off the coast of California the fall winds and climate can be fairly mild, whereas the winter typically has periods of intense, storm-driven winds. Much of the literature on winds along the northwest coast is concentrated on the spring and summer months (Beardsley et al. 1987; Rosenfeld 1988; Bane et al. 2005; Largier et al. 2006a), since this is the time of year when southward winds drive the upwelling of deep-ocean, nutrient-rich waters along the Northern Study Area. This process is important for biological productivity.

The oceanographic response to the winds varies with the square of the wind speed which is computed as the wind stress. Therefore the relationship between wind speed and the oceanic response is related to the wind stress, not just the wind speed. Literature examining currents in the coastal region, especially in describing upwelling, reports the wind as either the wind vector or the wind stress (Beardsley et al. 1987; Rosenfeld 1988; Dorman and Winant 1995). The latter shows a stronger relationship with the ocean current response.

1.2.1.1 Spring/Summer Winds Along the Northern Study Area

In this section the seasonal influence of alongshore and cross-shore variability and structure of coastal wind is reported along with seasonally influenced diurnal patterns. A good representation of the seasonal oscillations of coastal winds along the coast can be seen in [Figure 1.9](#) ([buoy positions are discussed in Section 1.1, Data Sources and Analyses](#)). In general, winds during the spring/summer are strong and persistent from the north along the California and Oregon coast. Along the Washington coast winds are weakly northward at the beginning and end of the spring/summer and weakly southward during the summer.

[Figure 1.7](#) depicts the mean surface pressure pattern off the Northern Study Area during the spring/summer season of 2001 (Bane et al. 2005). The Aleutian Low is far to the north in the Gulf of Alaska during this time of year and has a small, but not insignificant, influence on coastal winds off the coasts of Washington and Oregon. The North Pacific High dominates the surface flow by driving the winds southward along the entire Northern Study Area. In this document, for simplification, the winds will be assumed to be geostrophic (i.e. the winds flow parallel to the contours of the pressure field). The Thermal Low during this time of year is at its strongest as the southwestern states are experiencing the warmest temperatures of the year. Bane et al. (2005) reported that coastal winds along the Washington and Oregon coasts were correlated with variability of the Aleutian Low, winds along the California and Oregon coasts correlated with variability of the North Pacific High, and there were insignificant correlations with the Thermal Low.

The strongest and most persistent mean surface winds during the spring/summer are typically found along the Northern California coast between lat. 39° N and lat. 40° N (Beardsley et al. 1987; Strub et al. 1987; Dorman and Winant 1995; Bane et al. 2005). QuickSCAT satellite scatterometer sensor mean spring/summer wind stress data in [Figure 1.8](#) for the same time period as the mean pressure field in [Figure 1.7](#) can be matched up with the pressure field (Bane et al. 2005). The wind stress vectors show that the wind is almost geostrophic, such that the vectors are directed slightly away from the North Pacific High. Wind stress is strongest along the Northern California coast, where southward flow is directed along the coastline. Farther north, in southern Washington, the mean wind stress is weaker and directed more onshore, reflecting the mean position of the Aleutian Low. The most significant alongshore change in the wind stress typically occurs along the Oregon coast. Samelson et al. (2002) found that wind stress increases (which translate into increases in surface currents) from north to south along the Oregon coast by a factor of three to four. The winds off the Oregon coast also have the greatest variability, reflecting the tendency for weak summer cyclones and anticyclones to pass north of Cape Mendocino (Dorman et al. 2000). Oregon is also in a region that is occasionally between

the influence of the Aleutian Low and the North Pacific High. Dorman et al. (2000) reported that maximum mean monthly wind speeds during the spring/summer were found during the month of May at NDBC buoys 46013 (Point Reyes) and 46023 (Point Conception); these speeds reached approximately 8 m/s (Figure 1.9). This figure also shows a region between buoys 46026 (San Francisco) and 46028 (Monterey Bay) where mean monthly southward winds are less than those in the regions to the north and south.

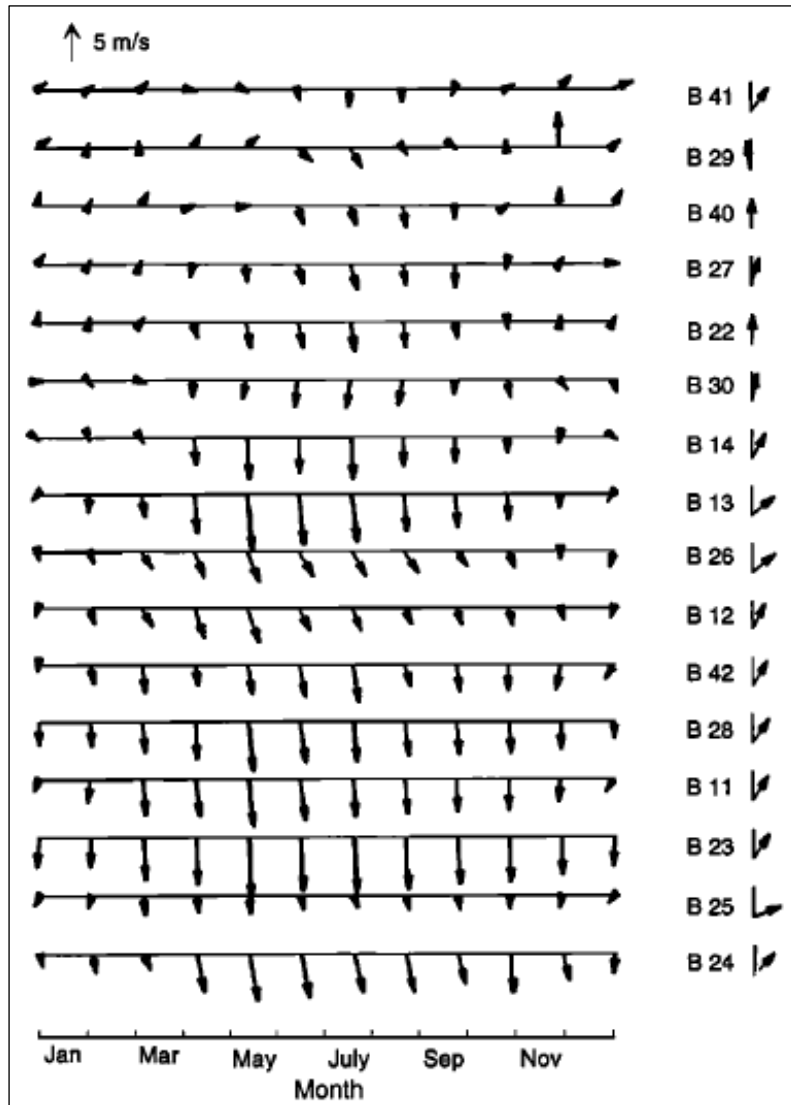

Figure 1.9. Annual cycle of the wind as recorded by NDBC buoys. For each location the vertical direction corresponds to the predominant direction of flow or “principal axes.” The relative orientation of that direction from north is shown at the right with the vectors pointing due north. The last two digits of each NDBC buoy are shown on the right, so that “B 41” refers to NDBC buoy 46041.

From Dorman and Winant (1995).

Orographic intensification of flow around capes and points along the Northern Study Area has been observed and is particularly relevant during the spring/summer season (Dorman et al. 2000; Samelson et al. 2002). Model and scatterometer results show an alongshore wind stress increase by a factor of two in less than 100 km off Cape Blanco, Oregon (Samelson et al. 2002). Significant increases in wind stress can be found in the vicinity of Cape Mendocino, Cape Blanco, Point Arena, and Point Sur (Dorman et al. 2000). For typical southward spring/summer winds this increase in wind stress is usually directly south of the Cape.

The southward wind stress begins earlier and ends later in the year along the California coast than it does along the Washington coast (Strub et al. 1987). [Figure 1.9](#) shows that wind stress along the Washington coast at the beginning and end of the spring/summer season is northward (i.e. the southward upwelling season is shorter at northern regions than at southern regions along the Northern Study Area). In contrast, south of San Francisco, the seasonal mean wind stress is continually southward and weakens only during the fall/winter. This continuously mean southward flow is due to the decreased influence of the storm track that is usually located to the north.

The predominantly southward winds are interrupted by brief periods of northward flow (Beardsley et al. 1987; Winant et al. 1987; Bane et al. 2005). Bane et al. (2005) reported that wind stresses on the order of 0.05 - 0.1 N/m² occurred about 75 percent of the time between May and August 2001 and the longest period of southward wind stress was from mid-June to the end of July with two brief northward wind reversals. Beardsley et al. (1987) reported similar findings, where strong upwelling-favorable winds of 7 - 15 m/s persisting along the coast for up to 30 days were interrupted by brief periods of weak or reversed flow. The periods of reversed flow were not correlated with a weakening of the North Pacific High. The reversals in flow were believed to be coastally trapped perturbations such as Kelvin waves or gravity currents. These reversals are often referred to as “southerly surges” and are typically caused by pressure perturbations affecting the slope of the marine boundary layer, creating a poleward pressure gradient force.

During the summer the atmospheric upper level jet stream is typically at its highest latitudinal position. Since the jet stream is often responsible for transporting low pressure systems, the influence of the Aleutian Low is diminished during the summer. Bane et al. (2005) reports that during the spring/summer season there is a correlation between the latitudinal position of the jet stream and winds along the Washington coast. When the jet stream moved southward, bringing low pressure systems toward the Washington coast, persistent southward winds reversed and were driven northward for one to several days. This is a completely different mechanism for driving brief northward winds than that mentioned above regarding southerly surges.

The winds along the Northern Study Area have a strong diurnal signal. Energy spectral analyses show defined peaks at the diurnal and semidiurnal frequencies

([Figure 1.10](#)). The energy spectra are “red-shifted,” in that there is more energy at longer frequencies (longer than a day) than at shorter frequencies. The diurnal signal in the wind stress

was found to be strongest during spring/summer along the northwest coast of California (Rosenfeld 1988; Kaplan et al. 2005).

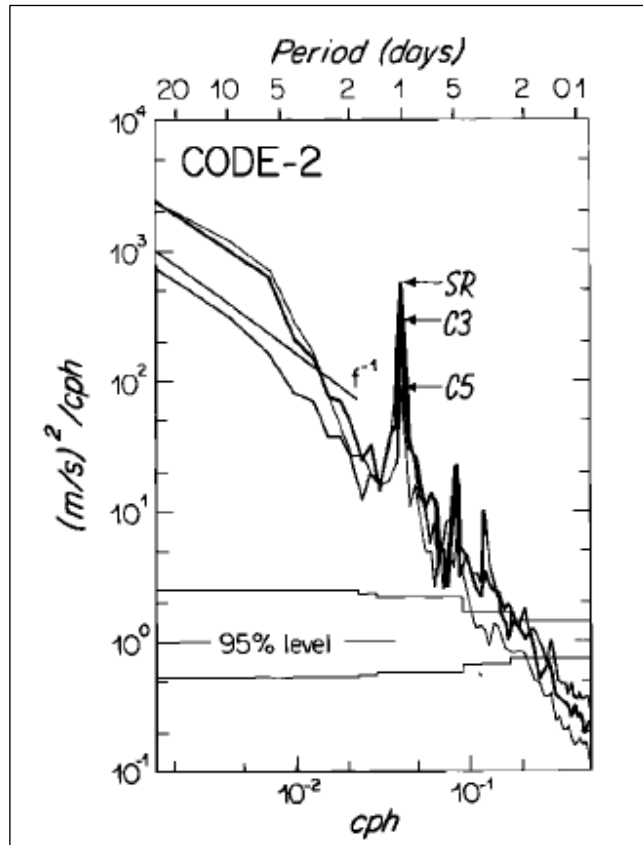

Figure 1.10. Kinetic energy spectra of wind measured at sensor height at Sea Ranch (Northern California coast), the data are from buoys C5 (30 km offshore), C3 (10 km offshore), and SR (0 km offshore).

The 95 percent confidence limits are shown and the straight line shows the -1 slope for reference. “cph” is “cycles per hour” and represents the frequency.

From Beardsley et al. (1987).

Presumably, a similar pattern should be observed along most of the northern study region, but no specific studies were found.

Although the diurnal signal in the winds is linked to the daily daytime/nighttime heating/cooling along the coast, this diurnal signal is not considered a diurnal “sea breeze” in the classical sense. In the classical definition of a “sea breeze,” daytime heating over land while air over the ocean remains cool creates an onshore pressure gradient that drives the wind directly onshore. Along

the Northern Study Area the diurnal signal in the winds is directed primarily alongshore and is referred to as the “daytime alongshore acceleration” (Beardsley et al. 1987).

There is a persistent cross-shore and alongshore structure to the coastal winds, particularly in the southern regions of the Northern Study Area. Winds are generally strongest and most persistent between 10 and 100 km from the coast; their maximum strength occurs at about 20 km offshore. Beardsley et al. (1987) developed a simplified three-dimensional model of the atmospheric structure along the Northern California coast when there is a typical spring/summer high pressure off the coast, the flow is southward, and there is a coastal mountain range affecting the flow. The model presented by Beardsley et al. (1987) is divided into three regions parallel to the coast: a nearshore zone 20 km from the coast, an intermediate zone from 20 - 200 km offshore, and an offshore zone from 200 - 1500 km offshore ([Figure 1.11](#)). In the offshore and intermediate zones the eastward tilt in the marine boundary layer is due to subsidence associated with the North Pacific High. In the intermediate zone, as the winds increase, the marine layer tilts more steeply to the east. The nearshore zone is the zone affected by diurnal variability. In the morning the sun begins to heat the land, destabilizing air that was stabilized overnight by radiative cooling. The destabilization allows southward winds offshore to migrate toward the coast as the tilt in the marine boundary layer steepens and a southward jet intensifies near the coast ([Figure 1.12](#)). [Figure 1.13](#) shows three cross-shore wind stress plots at 0 km, 10 km, and 30 km offshore. The offshore wind stress is persistent and southward, whereas the nearshore plot shows a strong diurnal oscillating pattern. Winds can flow perpendicular to the coast where they are funneled through gaps in the coastal mountain range such as the Golden Gate (Largier et al. 1993).

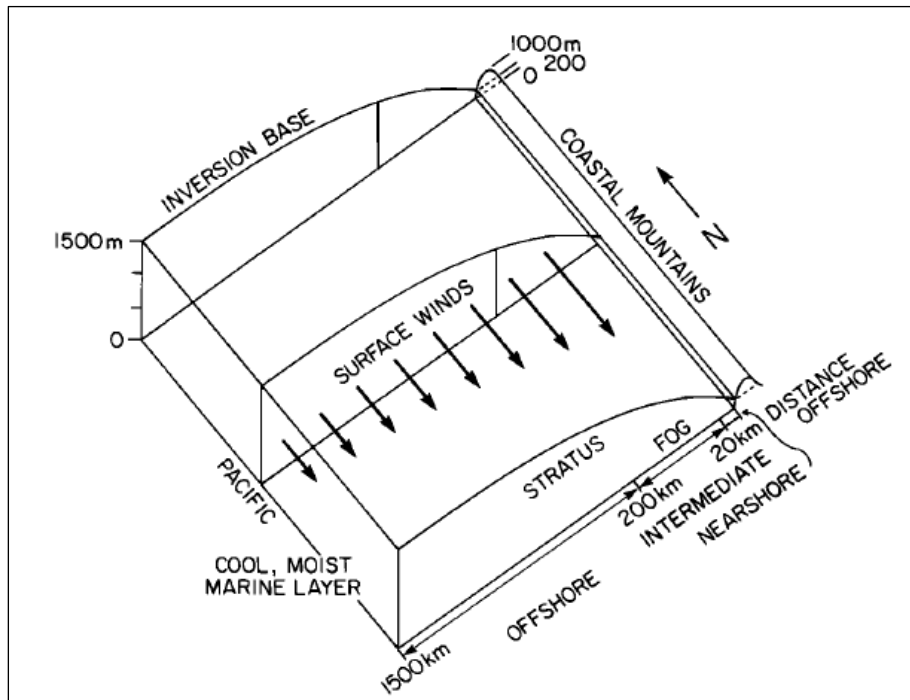

Figure 1.11. Conceptual model of the lower atmosphere over eastern North Pacific during periods of persistent south and southeastward winds in summer.

From Beardsley et al. (1987).

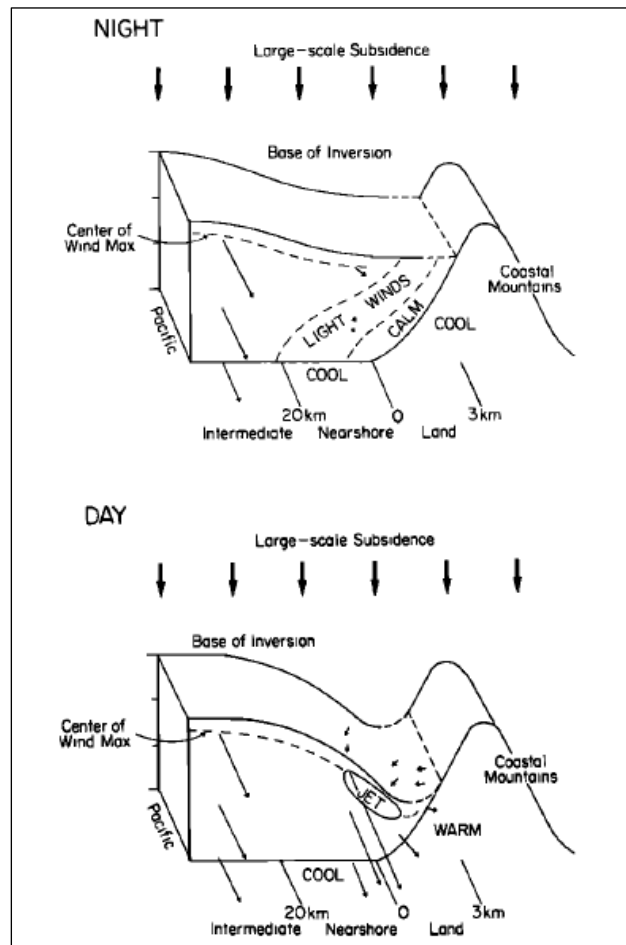

Figure 1.12. Conceptual model of lower atmosphere over the nearshore zone during (top) night and (bottom) day.

From Beardsley et al. (1987).

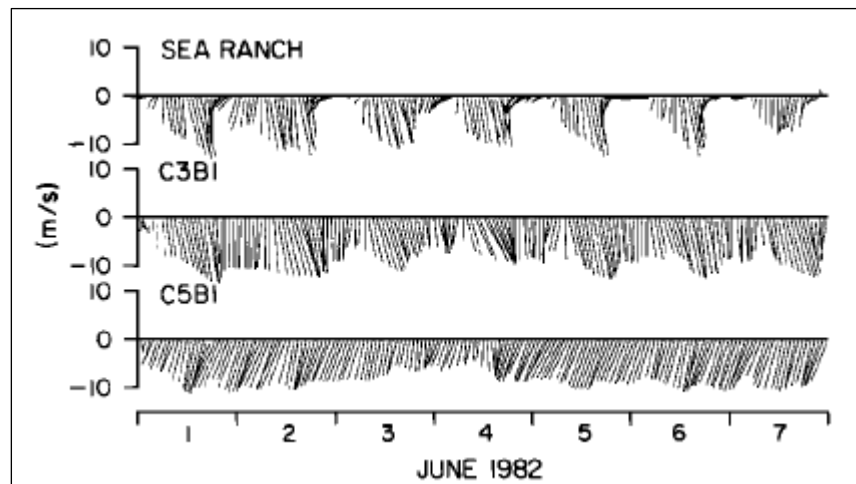

Figure 1.13. Surface winds at three locations across the shelf – Sea Ranch (0 km offshore), buoy C3 (10 km offshore), and buoy C5 (30 km offshore).

From Beardsley et al. (1987).

1.2.1.2 Fall/Winter Winds Along the Northern Study Area

The winds along most of the Northern Study Area during the fall/winter season are highly variable in both magnitude and direction. There are three main wind regimes during this time of year (Dorman and Winant 1995; Gough 2008): (1) weakened southward winds persist due to the weakening of the North Pacific High, (2) the frequency of storm-driven winds (cyclonic storm systems), which typically exhibit northward winds as they approach from the west and southward winds as they pass through to the east, and (3) offshore winds when atmospheric upper level ridges settle over the coast and a surface high pressure develops inland.

Mean winds are strong and northward along the Washington and Oregon coast and relatively weak and southward along the California coast (Figure 1.9). The switch in mean wind direction near the California and Oregon border during the winter is largely due to a southward shift in the storm track and a strengthening of the Aleutian Low (Shinker and Bartlein 2009). Approaching cyclonic storm systems and the Aleutian Low both drive the winds northward. At higher latitudes, the influence of the cyclonic systems and the Aleutian Low begins earlier in the year than at lower latitudes. This can be seen in Figure 1.9, showing that at buoy 29 (lat. 46°10' N) mean northward winds begin in October and end in June. In contrast at buoy 27 (lat. 41°30' N) northward winds begin in November and end in April. This trend continues down the coast until buoy 14 (lat. 39°13' N) where no mean northward winds are reported.

The North Pacific High influences the winds off the California coast all year but during the fall/winter the North Pacific High weakens and its influence decreases. The decreased influence of the North Pacific High, along with the periodic influence of northward winds associated with cyclonic storm systems, causes the mean southward winds observed during spring/summer to decrease during fall/winter (Dorman and Winant 1995). Mean winds off the California coast typically do not reverse but remain southward.

Since the wind regime is highly variable during fall/winter, the marine boundary layer typically does not have time to develop as it does during spring/summer. Storms and increased offshore winds tend to destroy the marine boundary layer. Therefore the three-dimensional coastal wind environment described in Beardsley et al. (1987) does not typically apply to the fall/winter along the Northern Study Area. At the coast during fall/winter, offshore winds tend to be stronger and last longer, since the temperature over land is cooler due to increased radiational cooling. Cool, dense air over land, particularly at night, creates an offshore pressure gradient due to the air density differential between air over sea and air over land. The diurnal sea breeze, if it commences at all, tends to diminish earlier, since the sun sets earlier and radiational cooling over land begins earlier in the day. Offshore wind events that last for up to four days are also caused by upper atmospheric ridges, which traverse slowly over the coast and create an offshore pressure gradient. This weather pattern creates a surface high pressure over the Big Basin (inland over the northwestern states) and drives the winds toward the southwest along the coast.

Two large-scale studies on wind stress disagree on the strength of the northward flow during the fall/winter along the Washington coast. Strub et al. (1987) found strong mean northward flow using buoy wind data from 1981 - 1983. Dorman and Winant (1995) found significantly weaker mean northward flow using buoy data from 1981 - 1990 ([Figure 1.9](#)). Both studies show that mean northward flow starts early in the fall and ends late in the spring, so that mean southward flow during the summer is very brief. The differences in these two studies could be due to natural interannual variations in the weather patterns or to differences in their methodologies: Strub et al. (1987) did a harmonic best-fit whereas Dorman and Winant (1995) used monthly means. Along the California coast both studies are in agreement showing mean wind stress directed toward the south.

1.2.2 Currents

The currents along the northwest coast of the United States display definite seasonal patterns that reflect the seasonally varying winds over coastal and deep ocean waters. Other mechanisms with seasonal influences on coastal currents are freshwater effluent forcing and buoyancy flows, seasonal heating and cooling, and large-scale open-ocean currents.

In the literature, southward winds along the West Coast north of the equator are often referred to as “upwelling favorable” winds, since Ekman processes transport surface waters offshore, forcing cold deep-ocean waters to be upwelling along the coast. Likewise, northward winds along the West Coast are often referred to as “downwelling favorable” winds, since Ekman processes transport offshore waters toward the coastal boundary and force downwelling of coastal waters. ([See Section 1.2.3](#) for an explanation of Ekman transport.) Therefore, it is sometimes best to separate the circulation patterns along the Northern Study Area both seasonally and into northern (Washington and northern Oregon) and southern (Northern California and southern Oregon) subregions, since the seasonal wind stress and sea surface pressure gradient patterns of the two areas are significantly different (based on findings of Strub et al. (1987)).

Most studies divide the coastal oceanic circulation patterns into two seasons: the spring/summer season and the fall/winter season (Huyer 1976; Hickey 1998). The spring/summer circulation is

primarily driven by southward “upwelling-favorable” winds along most of the Northern Study Area. As described in [Section 1.2.1](#), Winds, these winds are driven by the mean atmospheric large-scale surface pressure field, which has a high over the Pacific Ocean (North Pacific High), a low over the Gulf of Alaska (Aleutian Low), and a low over the southwestern United States (Thermal Low). Mean alongshore wind stress, however, is not directed toward the south along the entire Northern Study Area. Off the coast of Washington, southward alongshore wind stress is typically weak (or wind stress may even be directed northward) due to the location and influence of the Aleutian Low, even during the spring/summer months. This weak flow also allows an equatorward pressure gradient force to come into effect off the coast of Washington. During the fall/winter months the North Pacific High weakens and the influence from the Aleutian Low becomes more pronounced, causing southward wind stress to weaken along the Northern California and Oregon coast and northward wind stress to strengthen along the Washington coast. Along the California and Oregon coast this time period is also referred to as the “relaxation” season, and flow is often poleward due to a relaxation of upwelling-favorable winds allowing the poleward sea surface pressure gradient to dominate the flow. The cyclic shift from poleward to equatorward flow between seasons typically starts earlier in the year in the south and later in the year in the north (Strub et al. 1987). The seasonal cycle of alongshore wind and current velocity along the northwestern U.S. coast can be seen in [Figure 1.9](#) (winds) and [Figure 1.14](#) (currents).

The California Current System (CCS) exhibits considerable complexity due a multitude of fluctuating forces, which include wind stress, sea surface pressure gradients, and tidal and buoyancy flows. Other factors include flow interaction with complex coastlines, bathymetry, undercurrents, and offshore eddies. Note that the categorization of seasonal and spatial patterns can mask the complexity of the CCS. For example, Steger et al. (2000) found no seasonal pattern to circulation in the Gulf of the Farallones using six ship-board acoustic Doppler current profiler (ADCP) surveys spanning two years. They concluded that, although there are definite seasonal atmospheric and sea surface pressure gradient forces, complex orography and topography specific to the Gulf of the Farallones override the seasonal cycle.

Spatial sea level variations, which induce a current-driving pressure gradient force, have been found to have seasonal variability and to be linked to coastal winds (Largier et al. 1993) (Hickey and Pola 1983). Poleward flow off the Northern Study Area in the form of the California Undercurrent and the Davidson Current has been attributed to a poleward pressure gradient (Hickey and Pola 1983; Largier et al. 1993). The Davidson Current is a seasonal current that typically manifests itself as surface poleward flow over the continental shelf when southward coastal winds “relax” during the fall/winter months. Sea level pressure gradients have been found to oppose the prevailing wind stress and are directed poleward over the California coast and equatorward over the Washington coast (Hickey and Pola 1983). Since the pressure gradient forces typically counter the prevailing wind stress, it is believed that the pressure gradients are responsible for the development of undercurrents such as the poleward flowing California Undercurrent along the California continental slope and equatorward subsurface flow off the Washington coast (Hickey and Pola 1983; Kosro 2002).

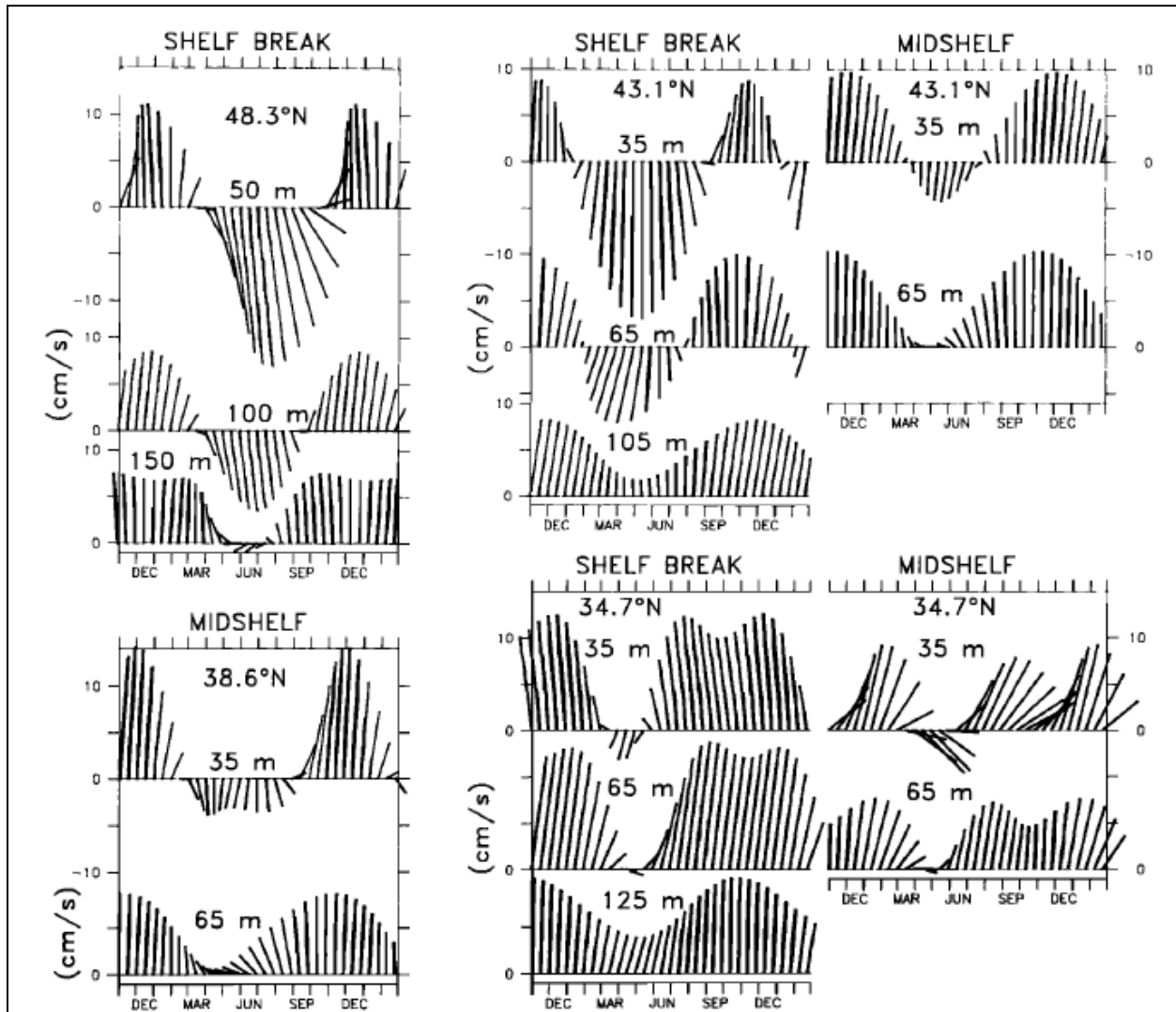

Figure 1.14. Harmonic fits to alongshore and cross-shelf components of the currents (sticks parallel to the vertical axis represent flow parallel to the principal axes of the mean flow).

From Strub et al. (1987) Figure 8.

There are some conflicting findings in the literature on the seasonal circulation patterns along the northwest coast. This is most likely due to natural seasonal variations in the meteorology, although discrepancies can also be influenced by intrinsic instrumentation differences and measurement techniques. Examples of anomalous flow patterns can be seen during the El Niño of 1997-98 (Kosro 2002) and during the spring/summer of 2002 off the Oregon coast, where strong equatorward advection was observed (Barth 2003).

A cause for confusion is the discrepancy in the naming of currents CCS. Steger et al. (2000) refers to poleward flow over the continental slope as the “Slope Countercurrent,” this flow could be considered part of the Davidson Current or the surfacing of the California Undercurrent. Lynn and Simpson (1987) refer to poleward flow over the continental shelf as the “Inshore Countercurrent;” typically, this same flow is referred to as the Davidson Current. In this

document, in order to avoid confusion (unless otherwise noted), poleward flow over the continental shelf during the fall/winter season is referred to as the “Davidson Current,” subsurface poleward flow along the continental slope is referred to as the “California Undercurrent,” and the equatorward current offshore from the continental slope is referred to as the “California Current.” Most of the time the properties of an identified current, such as direction, magnitude, depth, location, temperature, and salinity, are used to avoid confusion.

1.2.2.1 Currents Along the Northern Study Area During Spring/Summer

The generalization that southward wind stress along the Northern Study Area drives surface currents equatorward and that sea surface pressure gradients drive coastally trapped poleward currents (and undercurrents) does not hold completely true for the Washington coast, as it does for the California and Oregon coast.

During the spring/summer, flow off the Washington coast behaves like the relaxation poleward flow off the California and Oregon coast during the fall/winter, except that the spring/summer flow off the Washington coast is equatorward. Wind stress off the Washington coast is weakly equatorward for approximately two months in the middle of summer ([see Section 1.2.1, Winds](#)). The beginning and end of the spring/summer season exhibit northward wind stress. Despite the northward wind stress at the beginning and end of the spring/summer and only weak southward wind stress in the middle of summer ([Figure 1.9](#)), the currents off the Washington coast are strongly equatorward ([Figure 1.14](#)). The equatorward flow is most likely due to an equatorward sea surface pressure gradient (Hickey and Pola 1983; Kosro 2002).

Drifter studies during the upwelling season along the Oregon coast show a contrast in equatorward flow north and south of Cape Blanco: North of Cape Blanco the flow is complex and weakly equatorward, and south of Cape Blanco the flow is strong and equatorward (Barth 2003) ([Figure 1.15](#)). [Figure 1.15](#) exhibits two important aspects of the flow: (1) the weaker flow in northern Oregon is a transition area between the strong, upwelling-forced equatorward flow off the southern Oregon and Northern California coast and weak equatorward (or even poleward) flow off the Washington coast and (2) flow varies interannually. The black lines show anomalously strong equatorward flow during the 2002 upwelling season. At Newport, the upwelling jet is likely to be found over the shelf; in southern Oregon, the jet is separated from the coast. The separation appears to be influenced by Cape Blanco, where cool, recently upwelled coastal waters from the north are transported offshore as far as 300 km (Barth and Smith; Barth et al. 2000). Warm saline California Undercurrent water from the south is incorporated into this offshore transport and intermixed with the cool waters from the north. Eventually, the offshore flow returns to the coast south of Cape Blanco at about lat. 41° N. The anomalously strong, large-scale, upwelling-favorable wind stress leads to strong upwelling of cool, nutrient-rich, deep-ocean waters along the coast and increased eastward transport of subsurface subarctic waters in the North Pacific Current (Barth 2003). Anomalously strong wind stress can lead to hypoxic bottom water conditions due to increased organic material falling to the bottom (Barth 2003), which can have a negative impact on biological productivity even though upwelling is usually beneficial to biological productivity.

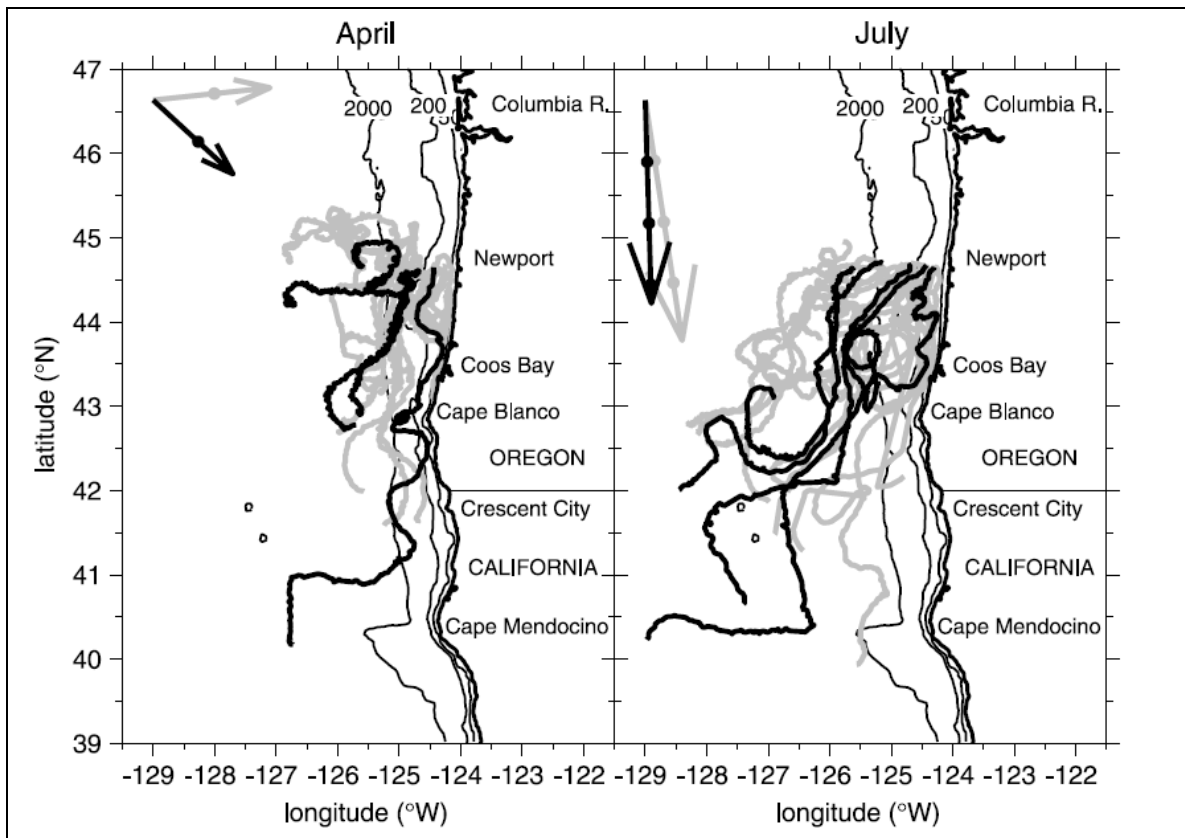

Figure 1.15. Drifter trajectories over 30 days from deployments in April (left) and July (right).

Trajectories in grey are from 1998-2001 and trajectories in black are from 2002. Average wind stress vectors are shown in black (2002) and grey (1998-2001) measured at NDBC buoy 46050. Isobaths are in meters.

From Barth (2003).

The spring/summer ocean circulation patterns off the California and Oregon coasts have been studied more extensively than have other regions and time periods along the northwest coast. This is primarily because the California and Oregon coasts are well-known upwelling regions, which have significant impacts on local ecology and biology. Surface currents in this region during the spring/summer months reflect the strong, persistent southward wind stress along the coast. Southward winds and accompanying equatorward surface flow can persist for periods up to 30 days and are interrupted by intermittent periods of relaxed or reversed (northward) winds (Beardsley et al. 1987; Largier et al. 1993; Dever 1997). During these intermittent periods when southward winds relax, surface currents tend to respond by flowing poleward. This poleward flow is believed to be driven by a poleward sea surface pressure gradient (Winant et al. 1987; Largier et al. 1993). The timing of the onset and termination of the southward winds along the coast in the early spring/late summer varies from year to year and depends on natural meteorological and climatic variations. Along the Oregon coast the upwelling season typically begins in May or June and extends to August or September (Barth et al. 2005). Along the California coast the upwelling season typically begins slightly earlier, in March or April, and extends to July or August (Largier et al. 1993; Kaplan et al. 2005). The time delay in wind stress between southern and northern regions is most likely due to the seasonal cyclic latitudinal

position of the upper atmospheric jet stream, which brings eastward-propagating low pressure systems from over the Pacific. These systems tend to weaken the North Pacific High (Barth et al. 2007). Cyclonic motion associated with low pressure systems also brings periodic northward winds. Both the time delay and relative strengths between southern and northern regions can be seen in [Figures 1.9 \(winds\)](#) and [1.14 \(currents\)](#).

High Frequency (HF) radar, which provides high spatial and temporal resolution of coastal surface current vectors, has provided a more detailed view of surface circulation off the coast than previously available. Recent studies on the circulation off Bodega Bay (Kaplan et al. 2005) and Gulf of the Farallones (Gough 2008) using HF radar have shown that equatorward surface flow during the upwelling season is typically strongest over the continental slope and outer shelf. The surface flow also displays considerable seasonal and interannual variability. Off Bodega Bay, March and April typically had the strongest equatorward flow. This equatorward flow was usually over the continental shelf and slope (Kaplan et al. 2005). As the upwelling season gradually ended in late summer/early fall, mean surface flow over the continental slope gradually declined and mean flow over the continental shelf reversed ([Figure 1.16](#)). In contrast, Gough (2008) found that the transition toward poleward relaxation flow at the end of the upwelling region in the Gulf of the Farallones showed poleward flow over the continental slope before poleward flow over the shelf developed. The apparent differences between Gough (2008) and Kaplan et al. (2005) regarding surface flow patterns at the end of the upwelling season are most likely due an abrupt change in coastline and continental slope at Pt. Reyes, which separates the Bodega Bay and the Gulf of the Farallones. The continental slope juts out at Pt. Reyes and outlines the widening of the continental shelf in the Gulf of the Farallones so that equatorward flow over the slope off Bodega Bay becomes equatorward flow over the shelf in the Gulf of the Farallones. Differences between Gough (2008) and Steger et al. (2000) (who believed there was no seasonal circulation pattern in the Gulf of the Farallones) are most likely due to differences between HF radar and ADCP data. HF radar measures surface currents, which are directly affected by seasonal winds whereas ADCPs (used by Steger et al. (2000)) measure subsurface current data.

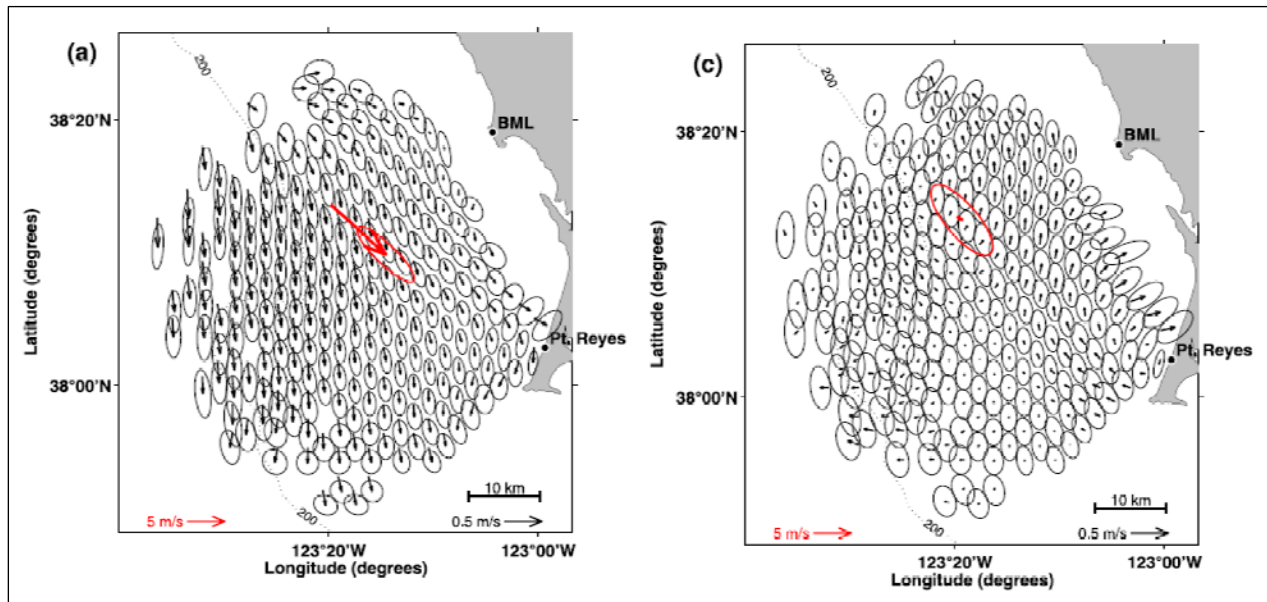

Figure 1.16. Mean surface currents north of Pt. Reyes for the months of June (left) and November (right) in 2001.

Black vectors indicate mean current flow and ellipses indicate one standard deviation of currents. Red vectors and ellipses indicate mean wind velocity and one standard deviation at NDBC buoy 46013.

From Kaplan et al. (2005).

1.2.2.2 Currents Along the Northern Study Area During Fall/Winter

With the onset of fall, the North Pacific High weakens and strong upwelling-favorable winds along the California and Oregon coast that were observed during spring/summer begin to relax, allowing a poleward sea surface pressure gradient to be observed. Off the coast of Washington, the Aleutian Low strengthens and northward downwelling-favorable winds increase in strength. There tends to be poleward flow throughout the entire Northern Study Area. Poleward flow off the California and southern Oregon coast is due to a poleward sea surface pressure gradient, whereas poleward flow off the Washington coast is due to northward wind stress.

Drifters deployed off the northern Oregon coast in October 1994, January 1998, and September 1998 show that currents tends to flow poleward and follow the Washington coastline (Austin and Barth 2002). Initially the flow was caught in an eddy field off the northern Oregon coast, where the wind field was variable. Eventually the drifters drifted north enough to get caught in strong poleward wind-stress-driven flow off the coast of Washington. Drifters then moved onshore due to Ekman processes and eventually accelerated poleward, closely following the coastline up along Vancouver Island. [Figure 1.17](#) shows the drifters during January, when wind stress was persistently poleward and there was no eddy field off northern Oregon.

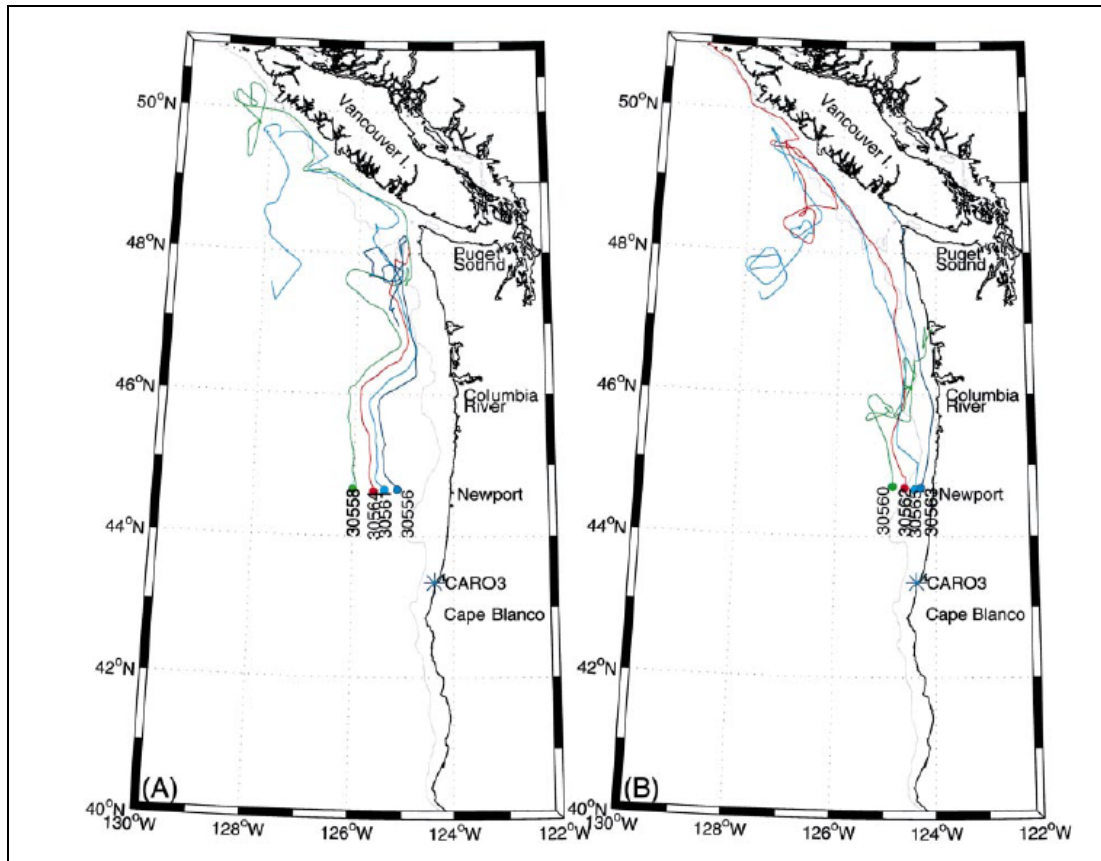

Figure 1.17. January 1988 deployment of drifters.

The two panels shown represent four drifters, each of the same deployment. Drifter paths from January 31 to April 15 are shown.

From Austin and Barth (2002).

A southward sea surface pressure gradient that opposes northward wind stress north of lat. 40° N could produce an equatorward undercurrent. Such a current has been observed in Quinault Canyon off the coast of Washington (Hickey and Pola 1983). Hickey and Pola (1983) also observed that in late winter a mean southward flow over the shelf occurs despite the mean wind stress being poleward. Mean southward flow over the shelf also preceded southward wind stress by several months. This emphasizes that seasonal circulation off the northwest coast is not due solely to wind stress.

Along the California coast south of Cape Mendocino, weak southward wind stress typically persists through the fall and winter months, but mean current flow is typically poleward as the poleward sea surface pressure gradient overrides the wind stress. Off Bodega Bay the poleward flow begins along the inner shelf in early fall and becomes more widespread during the winter (Kaplan et al. 2005). In the Gulf of the Farallones poleward flow develops over the slope in early fall while flow remains equatorward over the shelf (Gough 2008). [Figure 1.18](#) shows mean HF-radar-measured surface currents for the month of October in the Gulf of the Farallones. Eventually flow becomes poleward throughout the gulf in the winter. The strong poleward flow over the slope in the Gulf of the Farallones could be a surfacing of the California Undercurrent.

(Noble and Ramp 2000) observed a surface intensification of the California Undercurrent in the Gulf of the Farallones and postulated that the broadening of the shelf in this region forced the poleward undercurrent toward the surface and offshore. Conductivity, temperature and depth (CTD instrument that is used to calculate salinity and density) measurements of poleward flow over the continental slope in this region have been found to contain Pacific equatorial water, which is associated with the California Undercurrent (Steger et al. 2000)

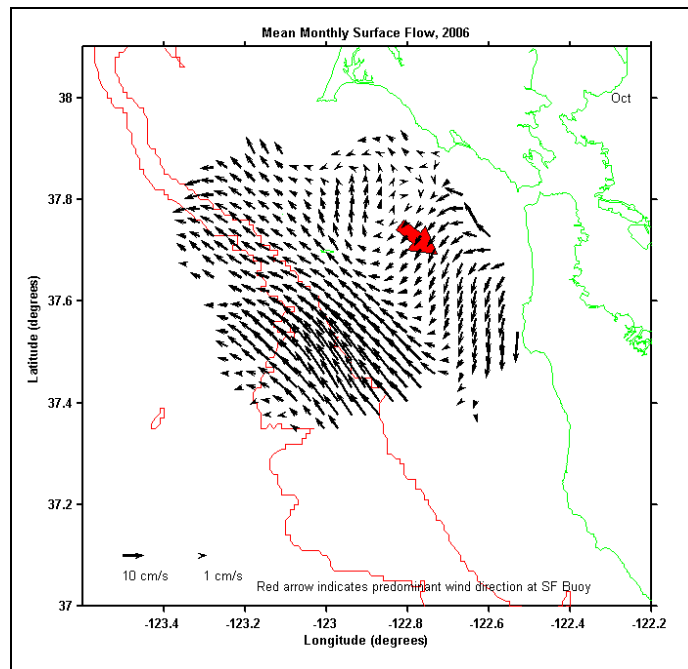

Figure 1.18. Mean HF-radar-measured surface currents in the Gulf of the Farallones for the month of October 2006 (black arrows).

Red arrow indicates mean winds measured at NDBC buoy 46026.

From Gough (2008).

1.2.2.3 Seasonal Influences of Sea Surface Pressure Gradients and Freshwater Effluent and Buoyancy Flows

During winter months, the equatorward sea surface pressure gradient, represented as the slope of the sea surface, off the coast of Washington is stronger than the poleward sea surface pressure gradient off the coast of California. During summer months the opposite is true as the equatorward sea surface pressure gradient off the coast of Washington is weaker than the poleward sea surface pressure gradient off the coast of California (Hickey and Pola 1983) (Figure 1.19). This supports the belief that alongshore wind stress sets up the sea surface pressure gradient. The poleward sea surface pressure gradient weakens later in the winter off the coast of California and may cause the weakening of the California Undercurrent during this time. Largier et al. (1993) observed a correlation between the wind stress and sea level pressure at Bodega Bay. Since this area has the strongest wind stress along the coast, Largier et al. (1993) postulated that wind stress could be the driving force setting up the sea surface pressure gradient.

Hickey and Pola (1983) generalized the alongshore sea surface pressure gradient as follows: (1) North of lat. 38° N the pressure gradient is seasonal: During October through June it is southward and from July through September it is northward. (2) South of lat. 38° N the pressure gradient is northward except January and February.

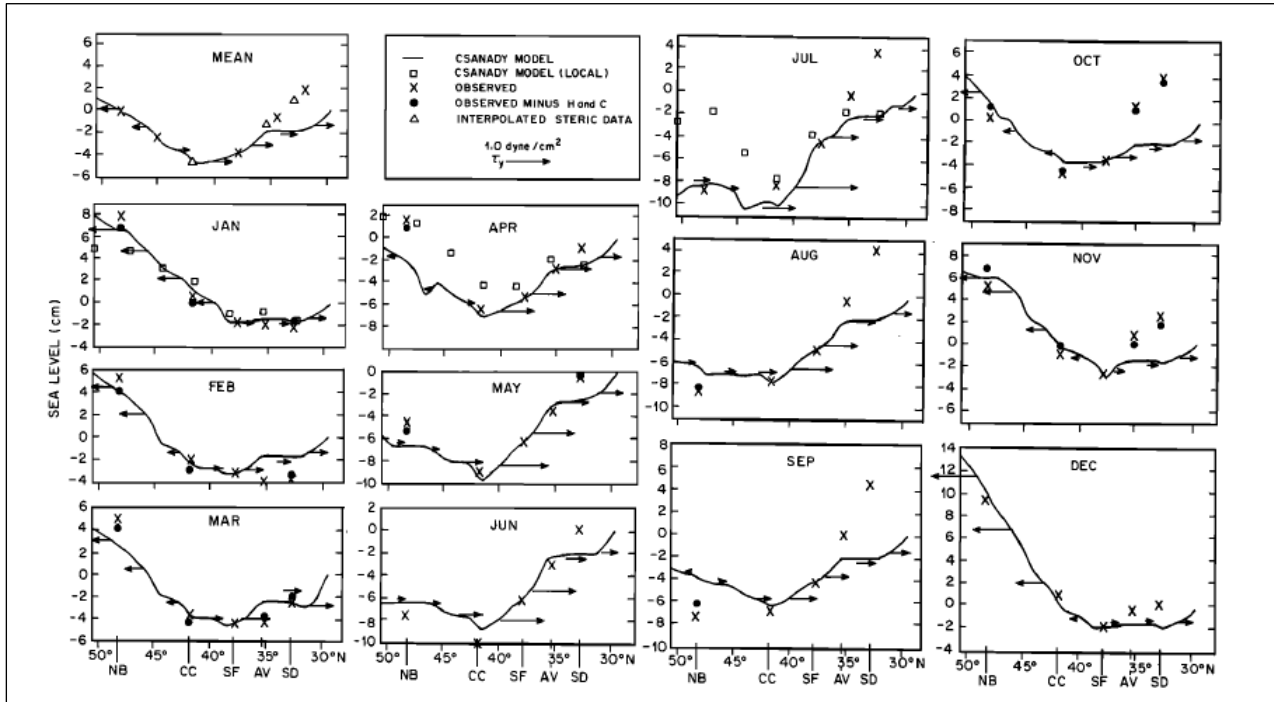

Figure 1.19. Observed and predicted sea level elevations as a function of latitude. Horizontal arrows indicate wind stress.

From Hickey and Pola (1983).

Buoyancy flows along the West Coast are caused by buoyant freshwater being directed poleward and trapped along the coast by the Coriolis effect. Rainfall and snowmelt runoff during the winter and spring create a seasonal signal of freshwater effluence. Along the Washington coast poleward currents can be influenced by poleward buoyancy flows from the Columbia River (Hickey et al. 1998). A poleward buoyancy flow from the San Francisco Bay is also believed to be important for the transport of San Francisco Bay water north of Point Reyes (Largier et al. 1993; Gough 2008).

1.2.3 Upwelling

Along the Northern Study Area upwelling is primarily caused by wind stress. Therefore, a seasonal variability in the winds ([as explained in Section 1.2.1, Winds](#)) produces a seasonal variability in upwelling. Likewise, any alongshore variability in upwelling usually reflects alongshore variability in wind stress. This alongshore variability in upwelling strength is often reported as the size of the upwelling index. A positive upwelling index is upwelling favorable and negative is downwelling favorable, whereas the magnitude represents the size of the vertical transport of water from upwelling. There are three coastal wind stress mechanisms that cause

upwelling: coastal Ekman transport, wind stress curl, and wind-stress-driven divergence of surface water. Any of these mechanisms can be the dominant factor driving the upwelling, depending on surface wind flow patterns, coastline shape, and bathymetry. These mechanisms can work with or against each other. Along northwest coast upwelling is responsible for bringing deep-ocean, nutrient-rich, cold, high-salinity water to the surface. This water is important for providing nutrients for the coastal biology. Most upwelling occurs along the coast of Oregon and California. The upwelling season is during the spring and summer months when there are persistent upwelling favorable (southward) winds along the coast. The upwelling season typically commences in early spring along the California coast and gradually makes its way up the coast such that upwelling commences off the Oregon coast later in the spring and off the Washington coast in early summer. The seasonal cycle of the winds along the Northern Study Area is described in further detail in [Section 1.2.1, Winds](#). The timing of the upwelling season varies from year to year due to natural interannual meteorological and climatological variability. The seasonal oscillation of the upwelling index off the coast of Oregon is shown below in [Figure 1.20](#). This figure also shows the alongshore variability of upwelling off the Oregon coast described below. The positive values during the spring and summer indicate upwelling and the negative values during the fall and winter indicate downwelling.

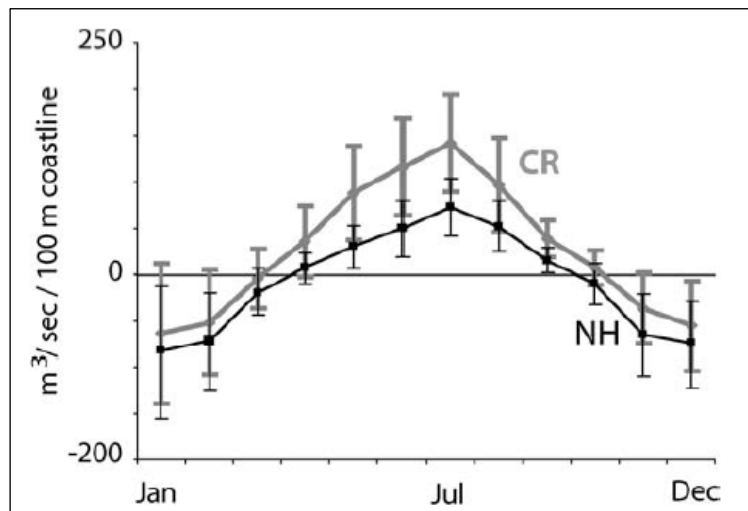

Figure 1.20. Long-term (1967-1991) monthly means (± 1 standard deviation) of the coastal upwelling index at lat. 45° N, long. 125° W (black, Newport) and lat. 42° N, long. 123° W (grey, Crescent City).

The index is proportional to the alongshore (southward) component of the local winds calculated from large-scale pressure fields.

From (Huyer et al. 2005).

Ekman transport is caused by the balance of wind stress and the Coriolis force integrated over layers of water in the water column. As a rule of thumb, surface water is transported at a 20 to 40 degree angle to the right (northern hemisphere) of the prevailing wind stress (Knauss 2005). Upwelling-favorable winds (southward winds) along the northwest coast transport water offshore

through Ekman processes. When this water is transported offshore, water from below is brought to the surface along the coastline in accordance with the law of conservation of mass.

Wind stress is seldom uniform across the ocean: It can vary in magnitude and/or direction. This variation is called wind stress curl, to indicate that there is a gradient in the strength or direction of the wind stress. Gradients in surface currents will occur if there is a curl in the wind stress. Depending on the sign of the wind stress curl, surface waters can either converge or diverge across the region where the wind stress curl exists. Horizontal surface Ekman water transport then induces upwelling (divergence) or downwelling (convergence). Positive wind stress curl, which generates upwelling along a west-facing coastline in the northern hemisphere is caused by weak southward winds at the coastline and stronger southward winds offshore. Local divergence at the surface by any acceleration, deceleration, or directional variation in the wind stress field can induce upwelling. When there is net divergence of mass at the surface, water from below is then brought to the surface to conserve mass.

Upwelling reflects the cross-shore structure of the alongshore wind stress field. Many studies have observed a southward wind stress jet over the continental slope and outer shelf of California and Oregon (Winant et al. 1987; Dorman et al. 2000; Kaplan and Largier 2006). The mechanisms causing this cross-shore structure in alongshore flow are explained in [Section 1.2.1, Winds](#). With winds near the coastline being light and increasing toward the jet over the continental slope, the conditions are favorable for strong positive wind stress curl, which causes upwelling (Winant et al. 1987). In addition to wind stress curl, strong, persistent upwelling-favorable winds along the northwest coast cause offshore Ekman transport. In this case, Ekman transport works in tandem with wind stress curl to intensify upwelling. Persistent upwelling-favorable winds during the spring and summer create a well-developed upwelling environment. [Figure 1.21](#) below shows the vertical shoreward progression, and eventual upwelling, of deep cold water over the inner shelf from May to August 2005 off the coast of Washington (Hickey et al. 2006). This figure also exhibits the progression of offshore transport of warm surface waters.

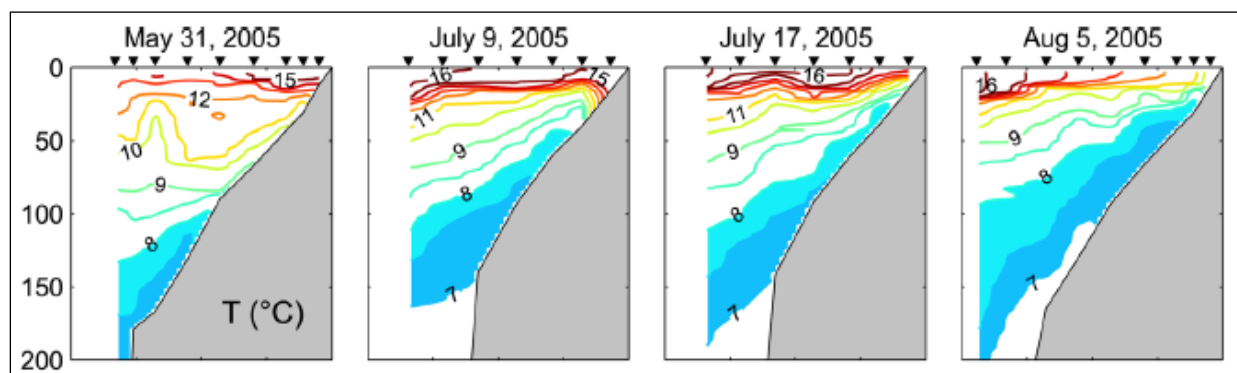

Figure 1.21. Cross section of the seasonal evolution of sea temperature over the continental shelf and slope off the coast of Washington.

From Hickey et al. (2006).

Although upwelling can occur anywhere along the northwest coast, the regions well-known for intense upwelling and cool, nutrient-rich coastal waters are along southern Oregon off Cape

Blanco (Barth et al. 2000; Huyer et al. 2005) and along Northern California off Cape Mendocino and Point Arena (Beardsley et al. 1987).

Cape Blanco (lat. 41.9° N) on the Oregon coast marks an important divide in the upwelling patterns along the northwest coast. Compared to the region off Newport, Oregon, the region off Crescent City, California (south of Cape Blanco), has a more saline, cooler, denser, and thicker surface mixed layer, a wider coastal zone inshore of the upwelling front and jet, higher nutrient concentrations in the photic zone, and higher phytoplankton biomass (Huyer et al. 2005). These differences were attributed to stronger mean southward wind stress, wind stress curl off Cape Blanco, and the reduced influence of the Columbia River discharge. The coastal upwelling index differences between Crescent City and Newport can be seen in [Figure 1.20](#). The combined influence of wind stress and wind stress curl on upwelling velocity can be seen in [Figures 1.22](#) and [1.23](#). Here, the relative strength of the wind stress at the two locations corresponds to the relative strength of the upwelling velocity, and the dip in wind stress curl corresponds to the dip in upwelling velocity at long. 125.25° W. The relative strengths of upwelling velocities between the two sites are reflected in the sea surface temperature field ([Figure 1.24](#)). These findings agree with other studies that have found orographic intensification of wind stress off Cape Blanco (Samelson et al. 2002) and other capes (Dorman and Winant 1995).

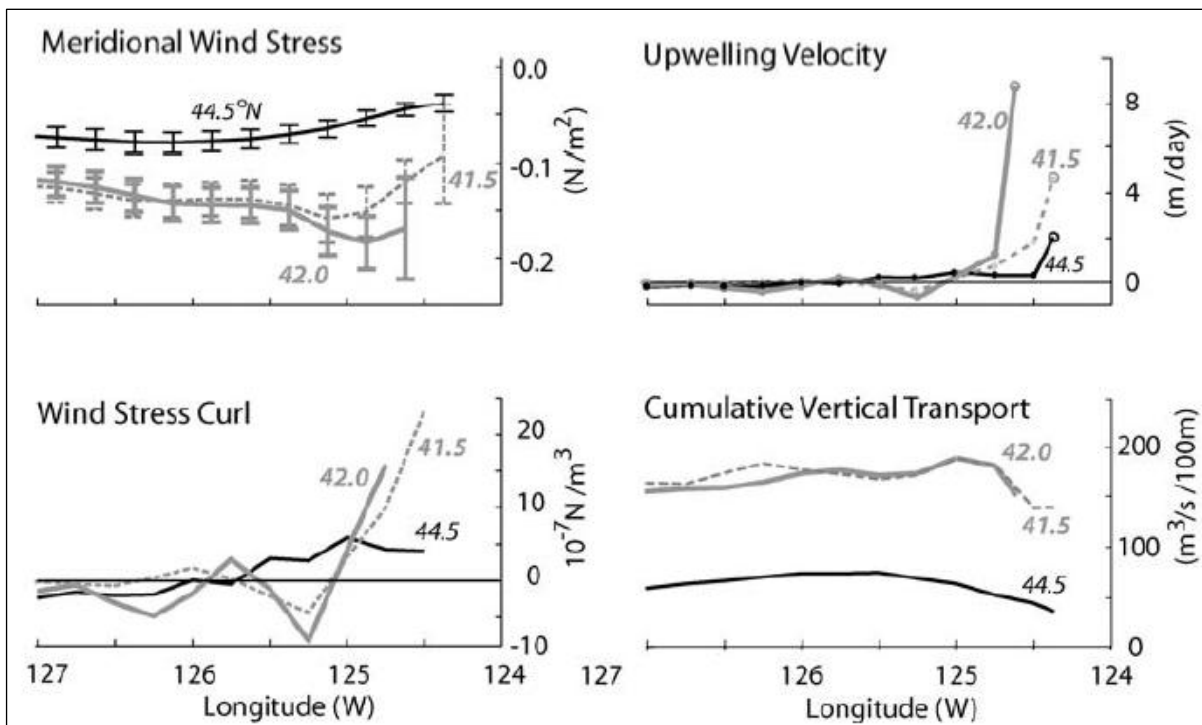

Figure 1.22. Zonal profiles of (upper left) meridional wind stress, (lower left) wind stress curl, (upper right) upwelling velocity, and (lower right) cumulative vertical transport at: lat. 44.5° N near Newport, and lat. 42.0° N and lat. 41.5° N near Crescent City.

From Huyer et al. (2005).

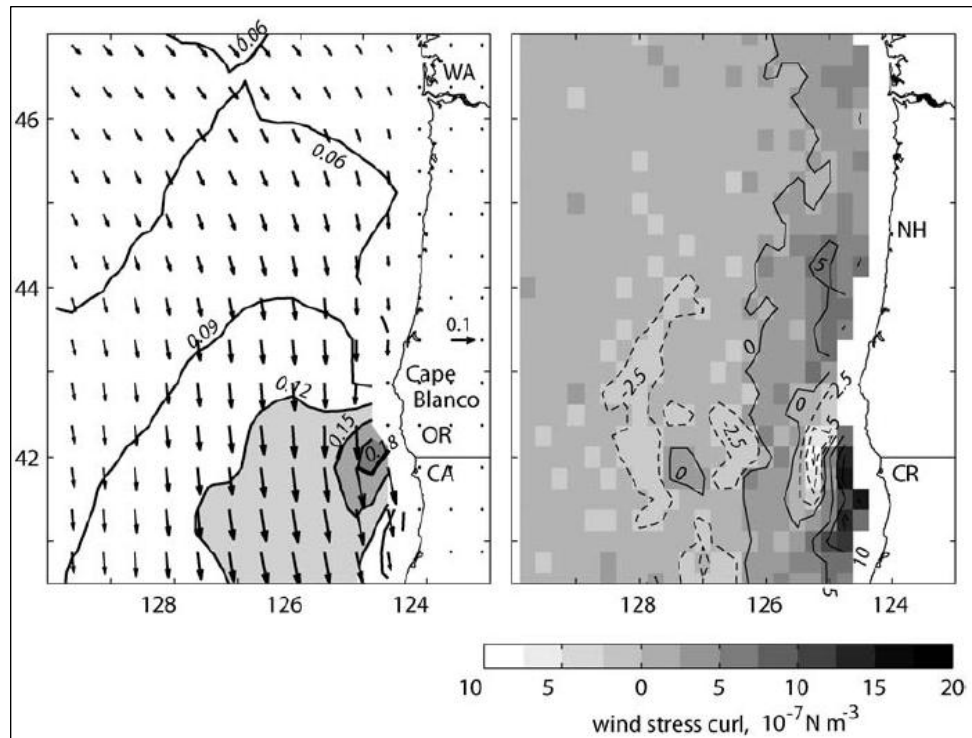

Figure 1.23. QuikSCAT mean July wind stress (left) and wind stress curl (right), 2002-2003. (left) Wind stress vectors and vector magnitudes (N/m^2). Every second vector of the 0.25-degree grid is shown.

Mean values are computed at grid points with 70 or more observations. (right) Curl of the mean July wind stress (10^{-7} N/m^3). First-order differencing caused the grid to be shifted 0.125° from the QuikSCAT grid, and the coastal data gap to widen. Positive (solid) contours are 5, 10, 15; negative (dashed) contours are -1.5, -5, -7.5. The 0 and -1.5 contours are shown only for larger features, ignoring small-scale oscillations.

From Huyer et al. (2005).

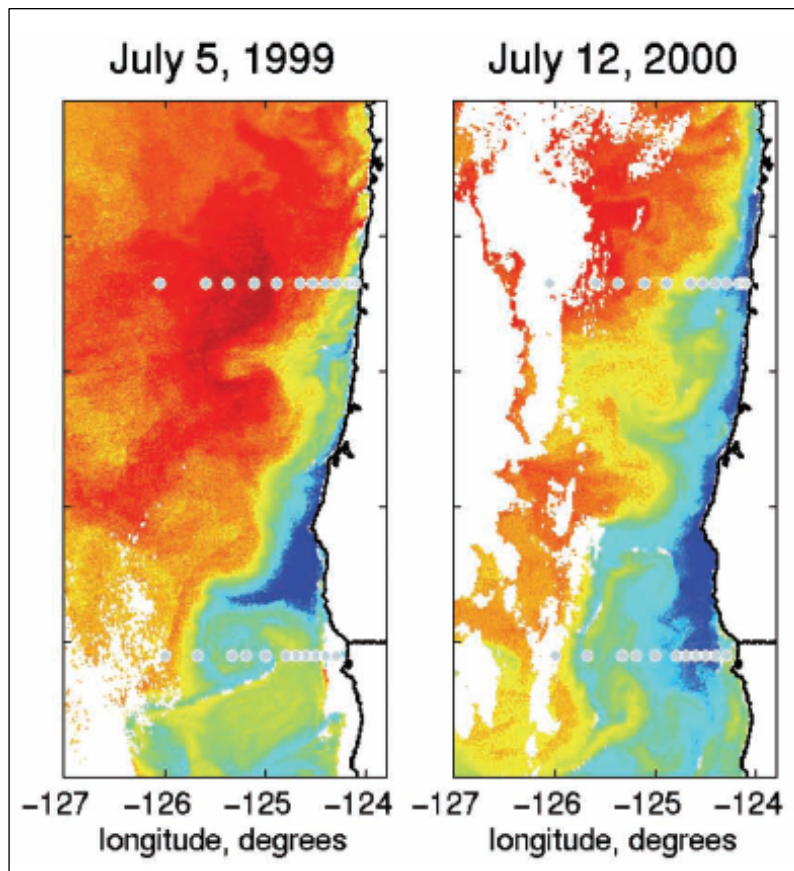

Figure 1.24. Satellite images of sea surface temperature for July 5, 1999, and July 12, 2000.

From (Huyer et al. 2005).

Upwelling along the Northern California coast has been studied intensively because of its impact on the biology in the region (Rosenfeld 1988; Largier et al. 1993; Wing et al. 1998; Gan and Allen 2002; Kaplan et al. 2005; Largier et al. 2006b). Largier et al. (1993) observed large plumes of cold water south of Cape Mendocino and Point Arena – both areas are well-known for upwelling. Gan and Allen (2002) used models of the flow along the Northern California coast and found that alongshore variability of upwelling was controlled by interaction among wind-forced shelf flow and coastline and bathymetry. In particular, capes were found to be associated with the strongest upwelling, due to the acceleration of the geostrophically balanced southward alongshore current.

Recent studies on the state of the CCS have recorded seasonal and interannual fluctuations in upwelling (Schwing et al. 2002; Peterson et al. 2006). Schwing et al. (2002) reported that the period 1998-2002 had the highest 4-year mean upwelling index since 1946, when data were first collected and that there had been stronger-than-normal upwelling since the La Niña in late 1998. The spring/summer of 1999 had the strongest upwelling on record and this strong upwelling trend lasted into 2000-2001. The seasonal fluctuations of the upwelling index between January 2000 and January 2002 for the entire CCS show strong anomalous positive (upwelling) values between lat. 36° N and lat. 39° N during the spring/summer months and negative values

(downwelling) north of lat. 39° N during the winter months ([Figure 1.25](#)). Only north of lat. 36° N does the upwelling index oscillate between positive (upwelling) and negative (downwelling) values. A warming trend of sea surface temperatures due to El Niño began late in 2002 and lasted three years, until the end of the study period in 2005 (Peterson et al. 2006). The upwelling season of 2004 was found to be weaker than normal and the upwelling season of 2005 was delayed by unusual weather ([Figure 1.26](#)). The upwelling maximum is further south and weaker than was found by Schwing et al. (2002) during previous years, which is probably due to the southward shift of the storm track during El Niños. The weakened upwelling from 2002-2005 has had a significant effect on the biology along the coast. During this entire period there was a decline in zooplankton biomass, which is part of a longer trend since the 1976-77 regime shift (McGowan et al. 2003). [Figure 1.21](#) above shows the upwelling of cold water off the Oregon coast in 2005 and the results of delayed upwelling-favorable winds. Even though the upwelling was delayed, the later-than-usual upwelling-favorable winds recovered the circulation to typical conditions later in the summer (Hickey et al. 2006).

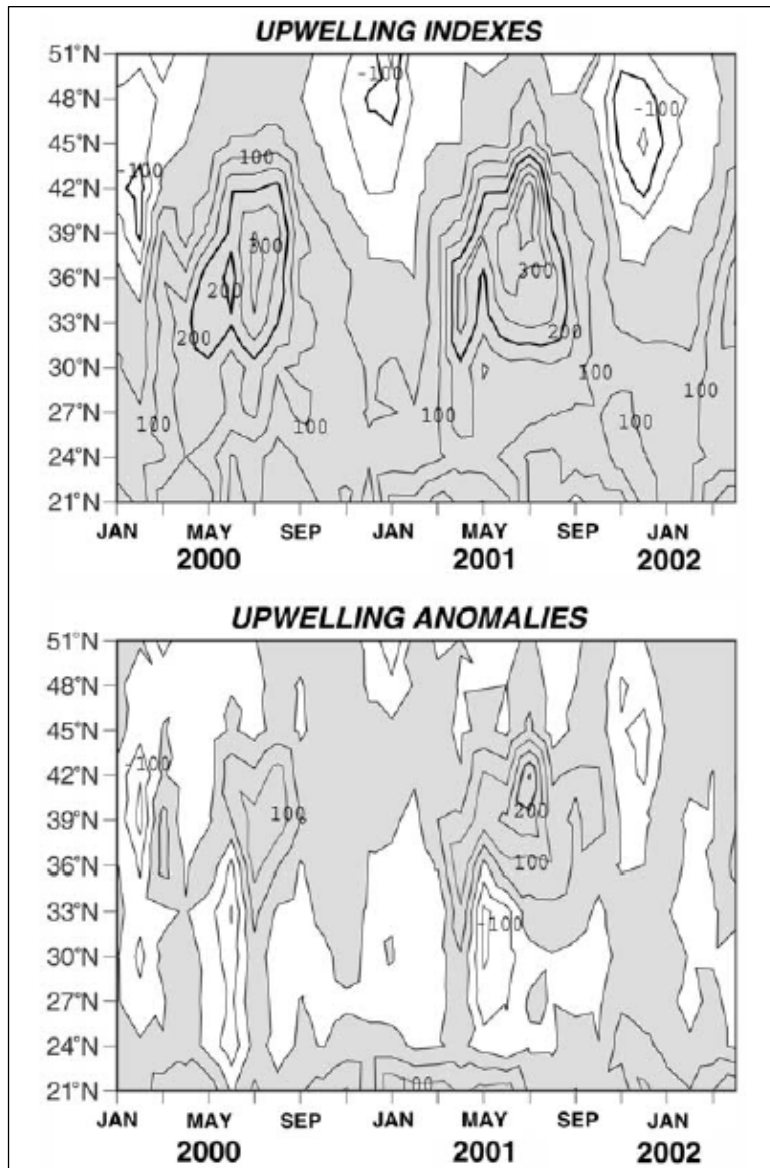

Figure 1.25. Monthly upwelling index and upwelling index anomaly for Jan. 2000 - Apr. 2001.

Shaded areas denote positive (upwelling-favorable) values in upper panel, and positive anomalies (generally greater-than-normal upwelling) in low panel. Anomalies are relative to 1947-68 means. Units are in m^3/s per 100 m coastline.

From Schwing et al. (2002).

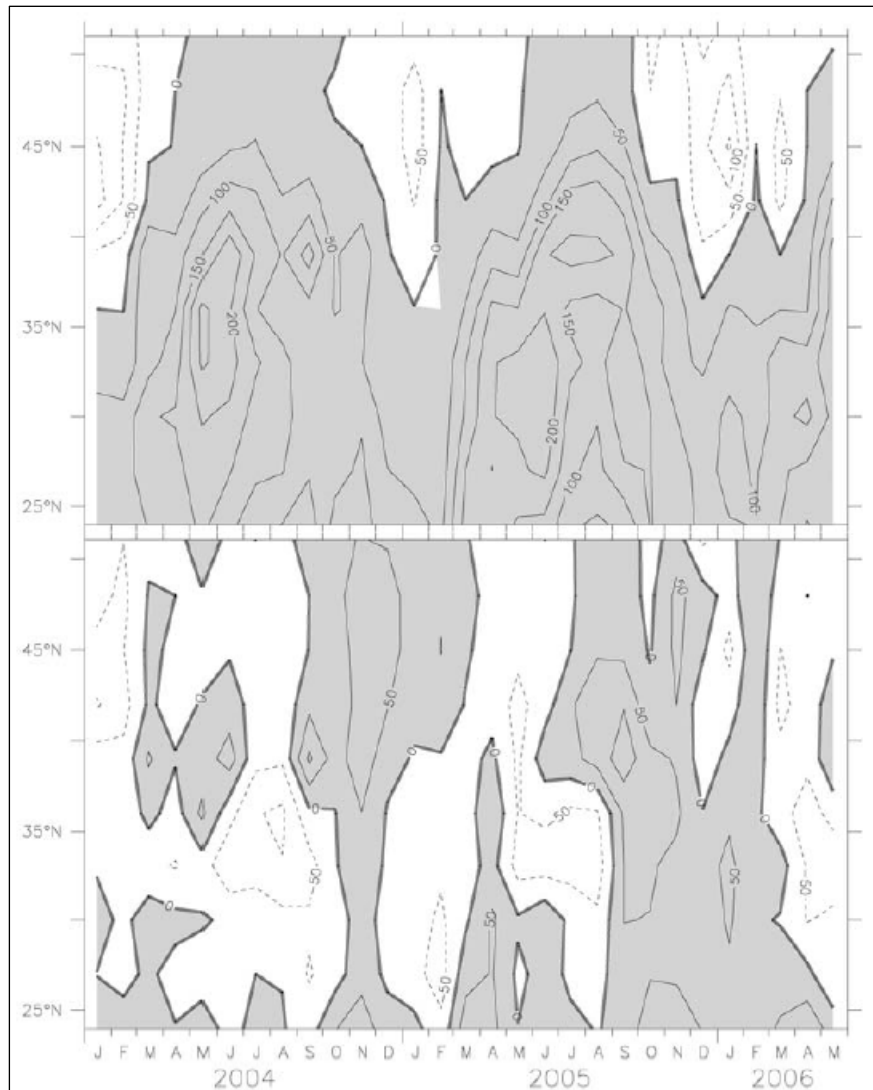

Figure 1.26. Monthly upwelling index and upwelling index anomaly for Jan. 2004 - Apr. 2006.

Shaded areas denote positive (upwelling-favorable) values in upper panel, and positive anomalies (generally greater-than-normal upwelling) in lower panel. Anomalies are relative to 1947-68 means. Units are in m^3/s per 100 m coastline.

From Peterson et al. (2006).

1.2.4 Water Properties

The waters in the eastern North Pacific Ocean are derived from three primary sources, the North Pacific subarctic water (PSW), North Pacific central water (PCW) and the North Pacific equatorial or subequatorial water (PEW). Waters from these sources are distinguished though slight differences in nutrients, oxygen, salinity, and temperature. PSW is characterized by low salinity and temperature and high oxygen and nutrients, PCW is characterized by high salinity

and temperature and low oxygen and nutrients, and PEW is characterized by high salinity, temperature, and nutrients and low oxygen (Hickey 1998). PSW is generally transported southward by the California Current, PCW enters the California Current from the west, and PEW is transported northward by the California Undercurrent. Temperature and salinity ranges are very small and the ranges of the different water masses overlap. Confounding the water mass distinction is the fact that along the shelf, upwelling of both PSW and PEW creates a mixture that is difficult to characterize using the classical temperature-salinity (TS) scatter diagram. More recently, the water mass identifier “spiciness” (Flament 1985) has been used to characterize the water properties of the coastal upwelled water (Huyer et al. 1991).

“Spiciness,” π , is defined as gradients that are approximately perpendicular to density gradients on TS diagrams. Spiciness measures a combination of warmth and salinity. In [Figure 1.29](#) the solid curved lines trending from the lower left to the upper right are lines of uniform density expressed as γ_t , the density anomaly. The dotted lines approximately perpendicular to lines of constant γ_t and trending from the upper left to the lower right are lines of constant π . π can be calculated as an absolute value or as the anomaly from a “standard curve.” Along a γ_t surface, the TS characteristics can move to the right as warmer, saltier water, which is called “spicy” or to the cooler, fresher π values or “bland” water. The different panels in [Figure 1.29](#) show how subtle this shift can be, illustrating why π is used in describing shelf and coastal water properties.

The overall surface temperature pattern shows the temperature increasing from north to south and east to west; offshore is generally warmer than along the coast at any latitude. During the upwelling period, coastal temperatures drop significantly from offshore values (Hickey 1998). The availability of satellite sea surface temperature (SST) imagery has significantly changed the view of the eastern Pacific ([Figure 1.27](#)). It is now well established that there are fixed upwelling locations and the upwelling plumes extend south from these locations. Often the upwelling plume bifurcates into two segments, one tending south and offshore and one tending south-southeast parallel to the shore (Largier et al. 2006b), [Figure 1.28](#). Surface temperatures in the central California coast region reflect the upwelling conditions more than they do seasonal heating and cooling. Surface temperature can shift between 8° and 14°C over small space (kilometers) and time (hours to days) scales (Roughan et al. 2006).

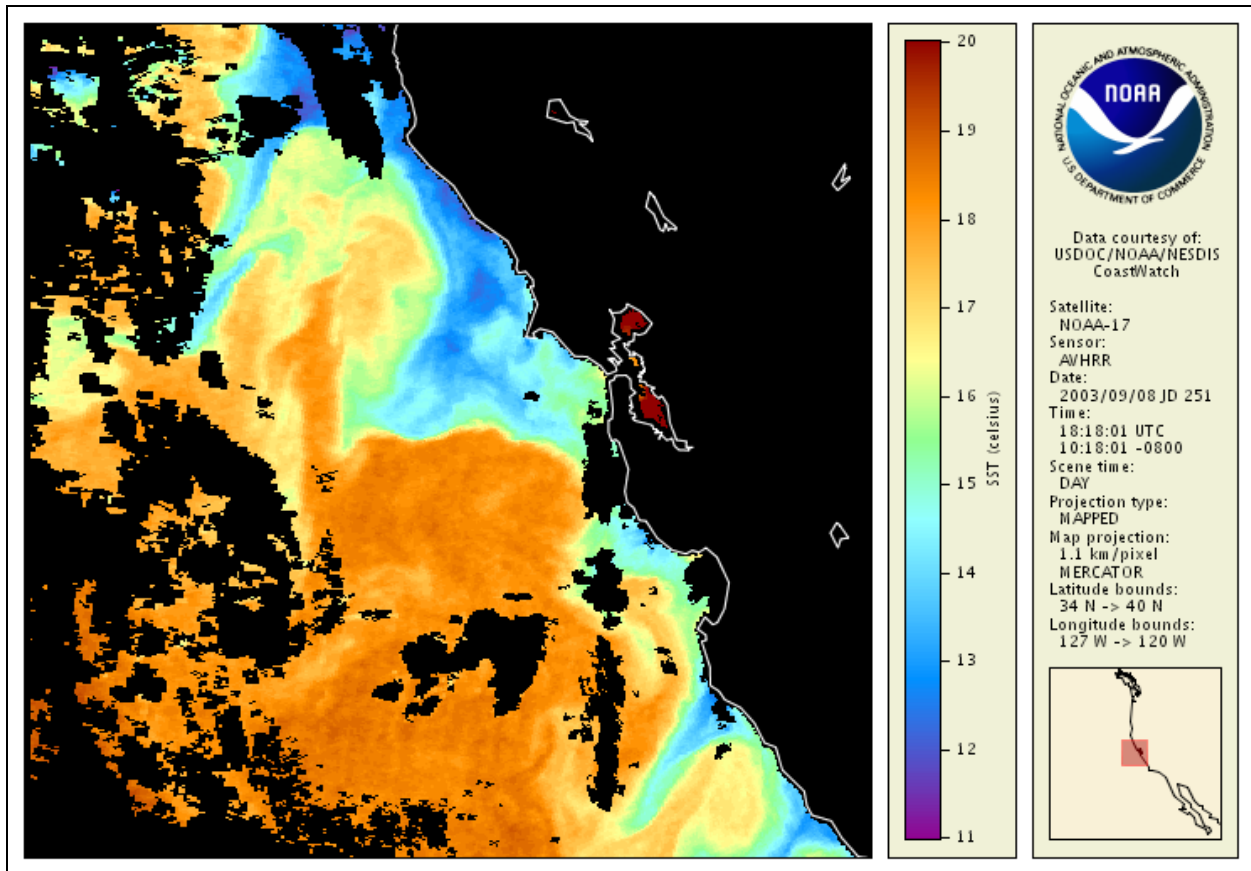

Figure 1.27. NOAA CoastWatch sea surface temperature image for the California central coast for September 8, 2003.

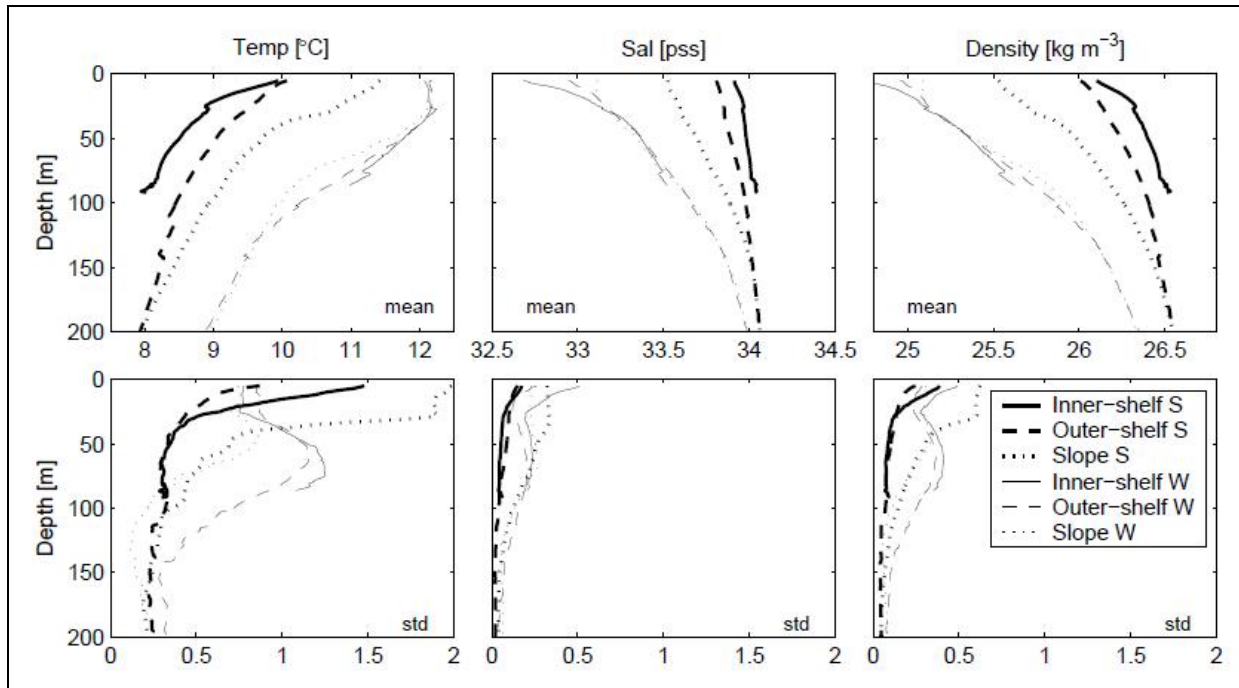

Figure 1.28. Vertical profiles of temperature, salinity and density for summer (thin lines) and winter (thick lines) for inner shelf (solid lines), outer shelf (dashed lines) and slope (dotted lines) for the NSF WEST program D-Line hydrographic stations extending offshore from Bodega, CA.

(Figure 4 from Roughan et al. 2006).

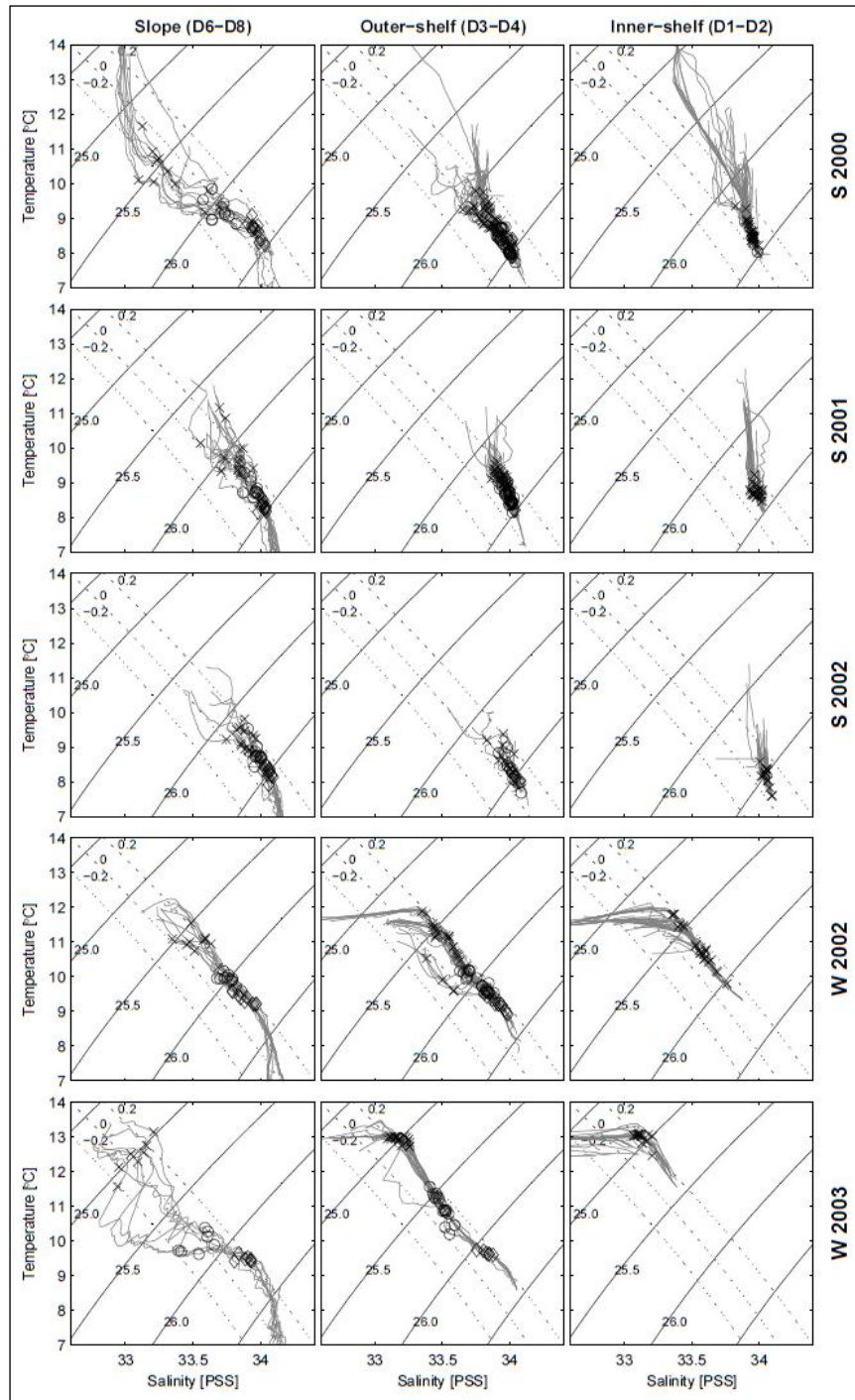
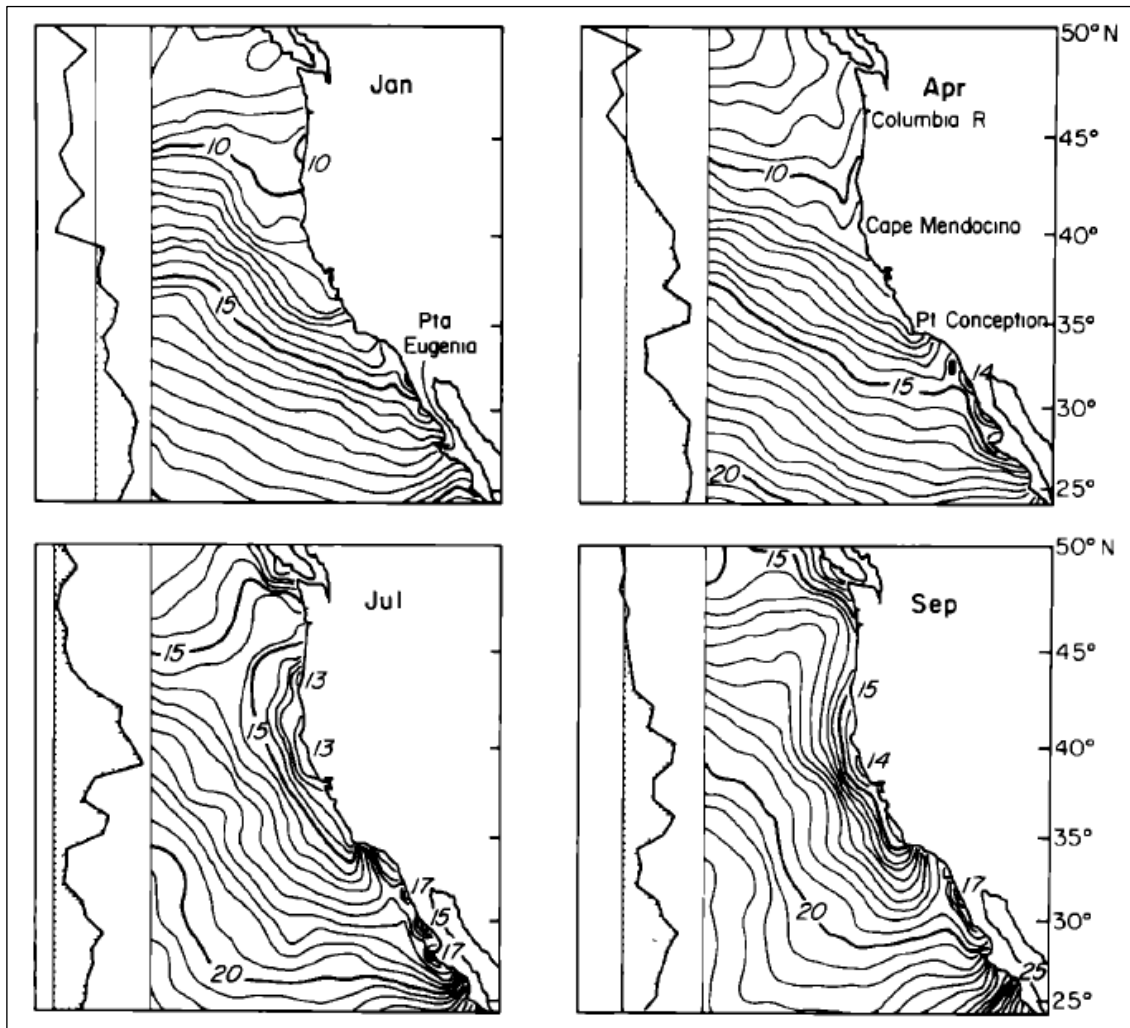

Figure 1.29. TS diagrams for all data acquired during the WEST cruises of spring 2000, 2001, and 2002 and winter 2002 and 2003 (from top to bottom) over the slope (left column), at the outer shelf (middle column), and at the inner shelf (right column) along the D-line off Bodega, California.

The crosses, circles, and diamonds mark depths of 50, 100, and 150 m, respectively.



From Roughan et al. 2006).

Figure 1.30. Maps of mean monthly surface temperature in the California Current region, lat. 24° N to lat. 50° N and long. 110° W to long. 135° W.

Shown with each map is the corresponding profile of the Ekman transport (offshore transport is shaded).

From Huyer (1983).

Salinity shows a somewhat similar pattern. There is a general increase in surface salinity from north to south and a general decrease in salinity from east to west. During times of high freshwater discharge there can be a low-salinity zone adjacent to the shore from the Columbia River and San Francisco Bay (Hickey 1998). Locally the smaller rivers can also discharge a low-salinity buoyant plume. Even the Columbia River plume is confined to the upper few meters. In the Central California coastal region, surface salinity can be almost fresh but usually varies between 31.5 and 34 PSS (Roughan et al. 2006). The higher salinity values are found associated with the upwelling plumes. Offshore salinity is generally less than 33 PSS and is a

mix of PSW and PCW (Huyer 1983). The base of the thermocline occurs around 8°C and 34 PSS. Waters below that value tend to show very little variability at any density level.

1.3 SUBTIDAL FLUCTUATIONS

1.3.1 Currents

Subtidal currents are responsible for the majority of the variance in the circulation off the northwest coast of the United States. The only exceptions are off the coast of the Strait of Juan de Fuca, the mouth of the Columbia River, and the Gulf of the Farallones and where strong tidal currents can dominate the flow. Subtidal currents include all circulation patterns not associated with tidal forcing. These include circulation due to wind forcing, sea surface pressure gradient forces, buoyancy flows, river outflow, inertial characteristics, mesoscale oceanic flow, and seasonal fluctuations. (Seasonal fluctuations in currents are covered in [Section 1.2.2](#), Currents.) Wind-forcing and sea surface pressure gradient forces are partially modulated by seasonal variations and are therefore discussed both in this section and in [Section 1.2.2](#), Currents. Buoyancy flow and river outflow characteristics are described in further detail specifically for the Columbia River Plume in [Section 1.3.2](#), Columbia River Plume.

There are three dominant currents that make up the California Current System (CCS): the California Current, the California Undercurrent, and the Davidson Current. The California Current is a large-scale surface current that flows southward off the West Coast of the United States between the continental slope and about 1,000 km offshore and is the eastern limb of the North Pacific gyre system (Batchelder et al. 2002). The California Undercurrent flows poleward along the continental slope between Baja California and Vancouver Island with maximum speeds (0.15 – 0.25 ms⁻¹) at depths typically between 150 m and 500 m (Hickey 1998; Pierce et al. 2000; Garfield et al. 2001). The Davidson Current is a seasonal poleward surface current that flows over the continental shelf off the California and Oregon coast during fall and winter (Hickey 1998). As the knowledge base about the CCS grows, researchers are finding that the structure of the CCS is much more complex than originally described and cannot be completely explained by the three currents mentioned above.

The winds along the northwest coast have the strongest influence on subtidal circulation and exhibit a wide range of frequencies ranging from minutes to years. Since the winds exhibit this wide range of frequencies, the surface currents (and some subsurface currents) follow suit. Rotary spectral analyses show definite peaks at the wind and current diurnal and semidiurnal frequencies, with the majority of energy in frequencies longer than a day ([Figure 1.31](#)) (Rosenfeld 1988; Kaplan et al. 2005). The diurnal and semidiurnal peaks in the currents are due to both semidiurnal wind forcing and tidal forcing at the diurnal and semidiurnal frequencies. The differences between the surface (a), 5 (b) and 9 (c) meters ([Figure 1.31](#)) are likely due to near-surface shear associated with diurnal wind forcing of the surface (Kaplan et al. 2005).

The clockwise dominance of the peak at a slightly higher frequency than the diurnal peak in [Figure 1.31](#) is due to inertial processes (i.e. the rotation of the earth) (Kaplan et al. 2005). The inertial frequency at this latitude is 1.24 cycles per day (cpd). Inertial variance was found to be greatest offshore, where there was a marked decrease in near-inertial frequencies. Inertial

currents behave like tidal currents since they have similar frequencies and amplitudes. Like tidal currents, inertial current motion tends to be elliptical.

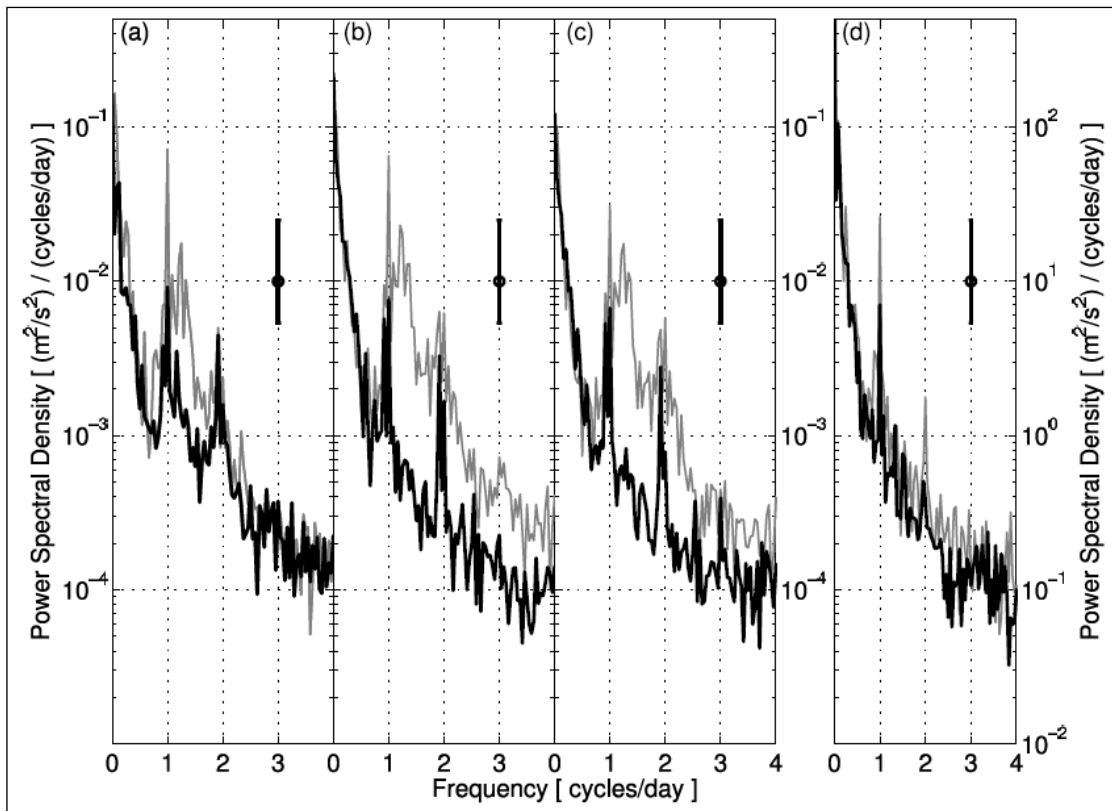

Figure 1.31. Power spectral densities from HF radar, ADCP, and wind data.

The (a) HF radar spectrum was calculated using the grid point nearest the C090 mooring, (b, c) Spectra are from 5 m and 9 m ADCP data at the C090 mooring, respectively, (d) Spectrum for NDBC 46013 wind data. The shaded line shows the power in clockwise-rotating fluctuations, while the black line indicates the power in counterclockwise rotating fluctuations. Error bar indicates 95 percent confidence interval.

From Kaplan et al. (2005).

Largier et al. (1993) characterized the subtidal spectra into three different bands: low frequency bands, corresponding to synoptic wind patterns; very low frequency (VLF) bands, with periods of weeks to months; and annual bands, which are due to seasonal cycles. The VLF band was found to be associated with alongshore variations in oceanic mesoscale forcing and not due to wind forcing. A composite spectral analysis of wind stress, currents, and sea surface pressure shows a peak in the currents within the oceanic mesoscale VLF band that does not appear to correspond to wind-forcing, as the closest wind stress peak is shifted toward higher frequencies (Figure 1.32). The seasonal peaks in the sea surface pressure, currents, and wind stress can be seen in the annual band, and the diurnal and semidiurnal peaks in wind stress and currents can be seen in the tidal band. An indication of relatively warm mesoscale eddies from over the ocean

basin impinging upon cold, newly upwelled coastal water can be seen in AVHRR satellite imagery (Figure 1.33). During these events wind stress did not correlate well with surface current measurements. Figure 1.33c illustrates a period of anticyclonic circulation off Northern California that has been observed in previous studies (Rosenfeld 1988). The transport of relatively warm offshore eddies toward the coast can cause variations in sea level along the coast (Largier et al. 1993).

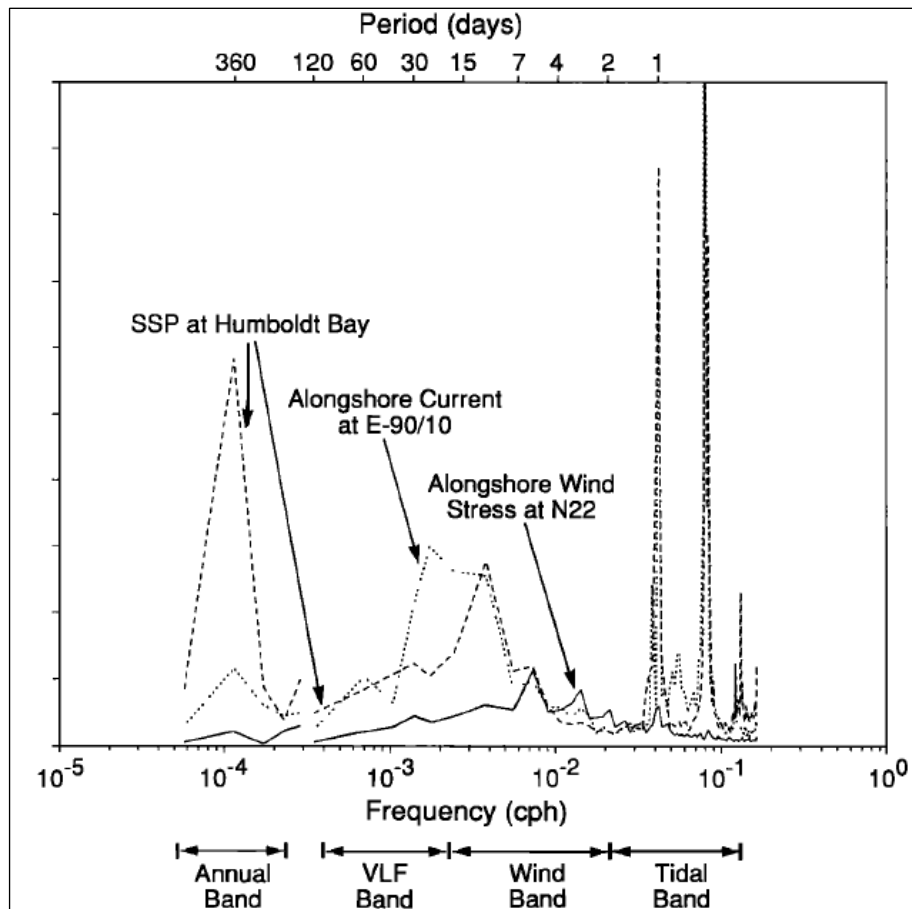

Figure 1.32. Variance-conserving spectra of wind stress at NDBC buoy 46022 (Eel River) (solid line), alongshore current at 10 m off Cape Mendocino (dotted line), and sea surface pressure (SSP) at the NOS tide gauge in Humboldt Bay (dashed line).

Spectra are computed from 2-year continuous records from April 1, 1987 through March 31, 1989. The vertical scale is linear and arbitrary; the spectra have been adjusted to coincide at about the 4-day period.

From Largier et al. (1993).

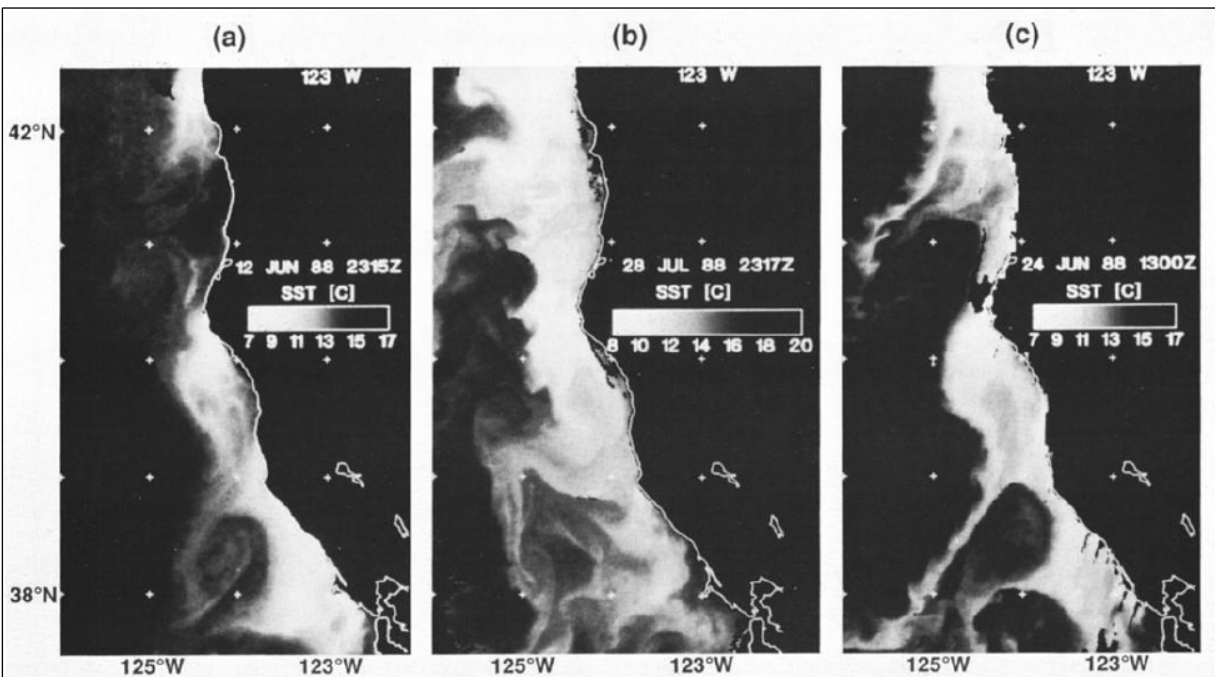

Figure 1.33. AVHHR images of sea surface temperature. (a) June 12, 1988.

Note the distinct patch of cold upwelled water on the south side of Cape Mendocino. At about the same time, currents at Cape Mendocino were strongly northward. (b) July 28, 1988. Note the warm intrusion of water moving poleward along the coast north of Point Reyes (lat. 38° N). (c) June 24, 1988. Note the warm feature southeast and offshore of Point Arena (lat. 39° N). Geostrophic flow around this feature is consistent with the strong equatorward nature of current observed on the shelf off Point Arena. A cold, cyclonic filament is observed immediately north of this persistent warm feature.

From Largier et al. (1993).

Correlations between wind stress and current fluctuations with sea surface pressure gradient fluctuations can be seen in [Figures 1.34](#) and [1.35](#). Strong, upwelling-favorable winds along the Northern California coast appear to influence the sea surface pressure gradient, which can remotely influence currents directly to the north and south of Cape Mendocino while also moderating the strength of the California Undercurrent (Largier et al. 1993). During a period of weak upwelling-season winds Largier et al. (1993) recorded strong poleward currents south of Cape Mendocino and strong equatorward currents north of the cape, which are indicative of sea surface pressure gradients. Significant correlations between sea surface gradients and wind stress were found only near Cape Mendocino and not at other locations along the coast.

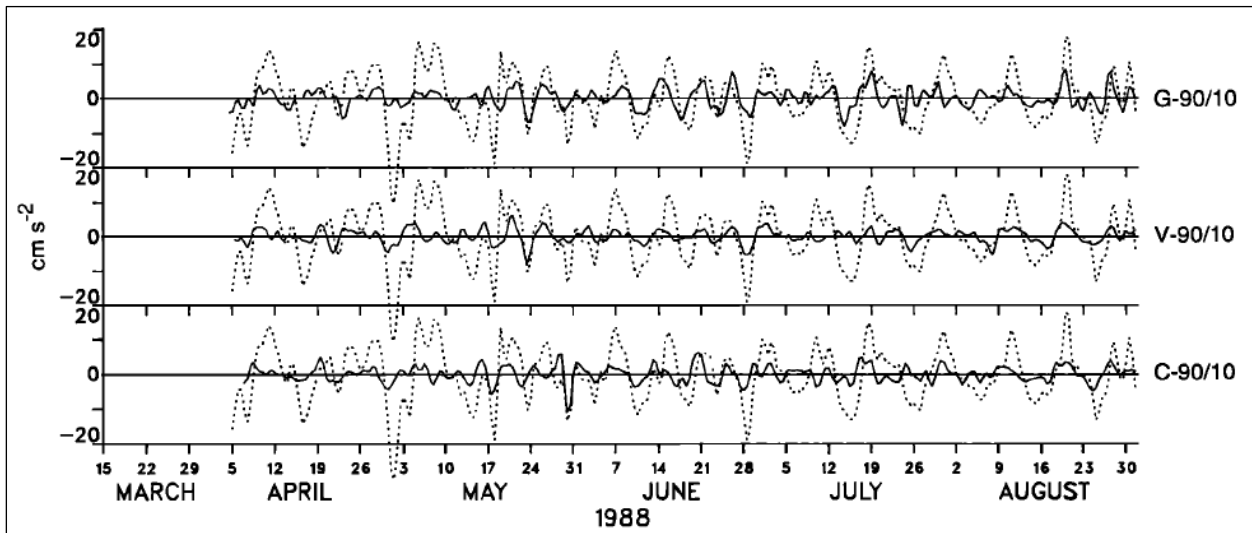

Figure 1.34. The acceleration in subtidal, near-surface alongshore current (solid line) at 90 m moorings along the Northern California coast compared with a subtidal record of the difference in SSP between Point Reyes and Humboldt Bay (dotted line).

Acceleration is calculated from centered 12-hour differences. The alongshore pressure difference is scaled by density to show equivalent units of cm/s^2 . Maximum correlations are 0.45, 0.52 and 0.50 for the respective plots, with acceleration leading the pressure difference by one increment of 6 hr. Positive values indicate poleward acceleration and larger SSP at Point Reyes.

From Largier et al. (1993).

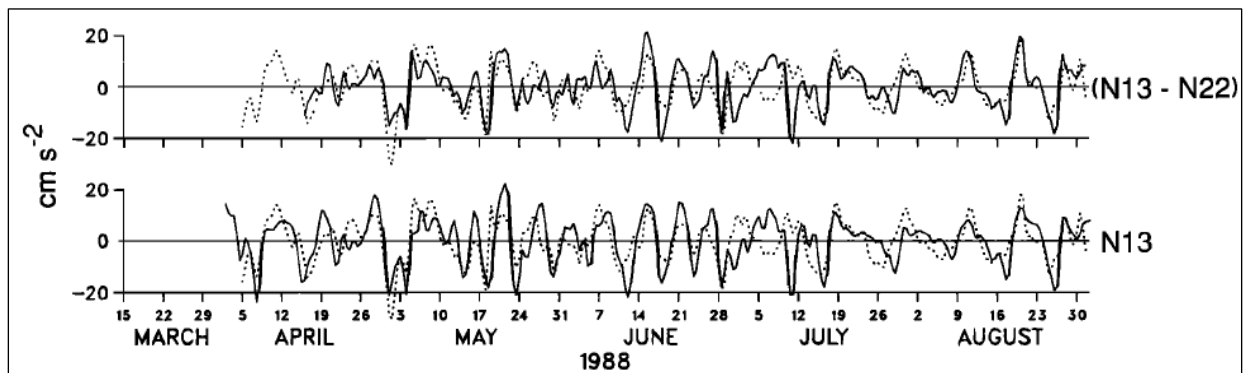

Figure 1.35. (top) Comparison of the subtidal alongshore difference in SSP between Point Reyes and Humboldt Bay (dotted line) with the subtidal alongshore difference in alongshore wind stress between buoys NDBC 46013 and 46022 (solid line). (bottom) Comparison of the difference in SSP (dotted line) with the alongshore wind stress at NDBC 46013 alone (solid line).

The alongshore pressure difference is scaled by density, and the wind stress is scaled by density and water depth to show equivalent units of cm/s^2 . Maximum correlations are 0.57 and 0.53, at zero lag, for the upper and lower comparisons, respectively. Positive values indicate poleward stress, poleward pressure gradients, and weaker winds at NDBC 46013.

From Largier et al. (1993).

The wind has been found to influence subsurface currents and sea surface elevation, in addition to surface and near-surface currents. Along-shelf wind stress has been found to cause currents to flow along the slope, parallel to the wind field, down to depths of 400 m (Noble and Ramp 2000). The seasonal alongshore pressure gradient, and its relation to the seasonal cycle in the poleward undercurrent, have phases that are consistent with the seasonal cycle in the winds (Hickey and Pola 1983). Noble and Ramp (2000), however, noted that the poleward flow pattern in the undercurrent was not affected by wind stress. The undercurrent has been observed to decelerate just north of Cape Mendocino (Largier et al. 1993). The undercurrent can be relatively shallow (100 m) during upwelling and can surface during the winter (Largier et al. 1993; Noble and Ramp 2000; Steger et al. 2000). There can be a strong shear environment between the equatorward wind-driven flow at the surface and the poleward flow at depth. A large range of subsurface eddy motion has been found to be associated with the California Undercurrent (Garfield et al. 1999; Garfield et al. 2001; Collins et al. 2004). Small, rapidly rotating eddies (submesoscale coherent vortices), also known as “cuddies,” are most likely caused by frictionally induced reduction of vorticity in the undercurrent (Garfield et al. 2001). Large eddy motions (radius greater than 50 km and period greater than 30 days) are most likely formed through baroclinic instability (Garfield et al. 2001; Collins et al. 2004).

In the absence of strong external forcing, a northern hemisphere low-density freshwater (or low-salinity) buoyant plume will turn anticyclonically and flow with the coast to the right of the direction of motion. As the buoyant plume moves along the coast it merges with the coastal currents (Wiseman and Garvine 1995). The anticyclonic motion is due to the Coriolis effect. Along the Northern Study Area buoyancy flows tend to flow poleward along the coast. However, buoyancy flows are strongly affected by coastal currents and winds and may not follow the typical poleward flow model. For example, reversals of the Columbia River plume have been attributed to wind forcing and coastal currents (Wiseman and Garvine 1995; Banas et al. 2008). Freshwater plumes affected by buoyancy forcing are usually associated with river discharge into the ocean, but estuaries can also discharge tidal pulses of freshwater or low-salinity plumes. These freshwater (or low salinity) plumes can have a seasonal signal associated with storm-season precipitation and spring snowmelt, a shorter-period signal associated with heavy precipitation events, and a tidal signal (usually diurnal or semidiurnal). The three largest contributors to plume-influenced flow off the northwest coast are the Strait of Juan de Fuca, the Columbia River, and the San Francisco Bay. The Columbia River plume is the most studied of the three and has the most significant effect on coastal waters, as it impacts both the Washington and Oregon coast (Wiseman and Garvine 1995; Hickey et al. 1998; Banas et al. 2008). Poleward flow from the San Francisco Bay may transport bay meroplankton to the nutrient-rich upwelled water off Point Reyes and Bodega Bay (Largier et al. 1993; Wing et al. 1998). There is evidence that this could be due to low-salinity plumes from the San Francisco Bay flowing like poleward buoyancy flow (Gough 2008). Poleward-buoyancy-like flow has also been observed from the Strait of Juan de Fuca (Macfadyen et al. 2005; Macfadyen et al. 2008).

1.3.2 Columbia River Plume

The Columbia River is the largest river on the West Coast of North America and it accounts for 77 percent of the total drainage between San Francisco and the Strait of Juan de Fuca (Hickey et al. 1998). The plume from the Columbia River has a significant affect on the currents, water

properties, and biology along the Washington coast to the north and Oregon coast to the south. The dominant timescales of Columbia River plume formation are dependent on the diurnal and semidiurnal tidal oscillations, tidal monthly changes in stratification, and seasonal changes in river flow. Maximum outflow occurs during late spring snowmelt and winter storms. In the absence of all other forces, a large freshwater discharge like that observed at the Columbia River mouth behaves as a “buoyancy flow,” where a buoyant freshwater jet rides over the dense saline oceanic water and is directed poleward (Wiseman and Garvine 1995). The freshwater should then meander poleward along the coastline like a trapped Kelvin wave. Wind stress, however, has a strong influence on buoyancy flows and the interaction of varying wind stress with the buoyancy flow creates a very dynamic environment. There are two generalized flow regimes observed with the Columbia River freshwater plume: (1) Southward upwelling-favorable wind stress causes the Columbia River plume to meander southward and offshore and (2) northward downwelling-favorable wind stress causes the plume to meander poleward and along the coastline.

A series of recent studies on the Columbia River Plume as part of the River Influences on Shelf Ecosystems (RISE) Special Volume has found new details on how Columbia River outflow mixes with ocean waters and how nutrients are transported across the continental shelf (Hickey et al. 2010). Maximum mixing of Columbia River water and ocean water occurs within the estuary and in the near field of the plume. Primary production has been shown to be higher in newly emerging plume water. Model studies demonstrated that cross-shelf transport is enhanced by 20% by the river plume. The regions north and south of the river mouth appear to be replete with iron and silicate. Although most plume nitrate originates from coastally upwelled water, river-supplied nitrate can help maintain ecosystems during delayed upwelling.

Phytoplankton biomass concentrations are generally higher off the Washington coast than off the Oregon coast despite mean upwelling-favorable wind stress averaging three times stronger off the Oregon coast (Banas et al. 2008). Since phytoplankton flourish in the nutrient-rich environment of upwelled water, it would be expected that Oregon would have higher biomass concentrations. Banas et al. (2008) provides evidence that the high concentrations of biomass off Washington are due to the Columbia River plume. During the spring and summer, persistent upwelling-favorable winds are interrupted by one to two days of downwelling-favorable winds. The upwelling-favorable winds send pulses of the Columbia River freshwater plume southward and offshore, and the switch to downwelling-favorable winds directs the plume northward and toward the coast. Models that omit the influence of the Columbia River plume show diminished cross-shore and bidirectional transport along the Washington and Oregon coast. The switching between downwelling-favorable and upwelling-favorable winds ensures that Columbia River outflow impacts the Washington coastline and regions offshore from the Oregon coast. Off the Oregon coast the plume is responsible for cross-shelf transport of nutrient-rich water. [Figure 1.36](#) shows the typical oscillating characteristics of the Columbia River plume during the summer. Off the Oregon coast, the biomass along a narrow band near the coastline is controlled by upwelling, whereas the offshore biomass is controlled by the nutrients provided by the Columbia River watershed.

Off the Washington coast during the fall and winter the predominant wind stress direction is toward the north, with intermittent switches in direction toward the south. This is the opposite of the spring and summer southward wind stress characteristics mentioned above. There are two basic structures to the Columbia River plume during the fall and winter (Hickey et al. 1998): (1) a thin (5 - 15-m), stratified plume directed west or northwest during southward or light northward wind stress; and (2) a thick (10 - 40-m), weakly stratified plume hugging the coast northward during northward wind stress. The thin stratified plume that is directed offshore can extend across the continental slope and over the ocean basin and is responsible for across-slope transport of Columbia River water.

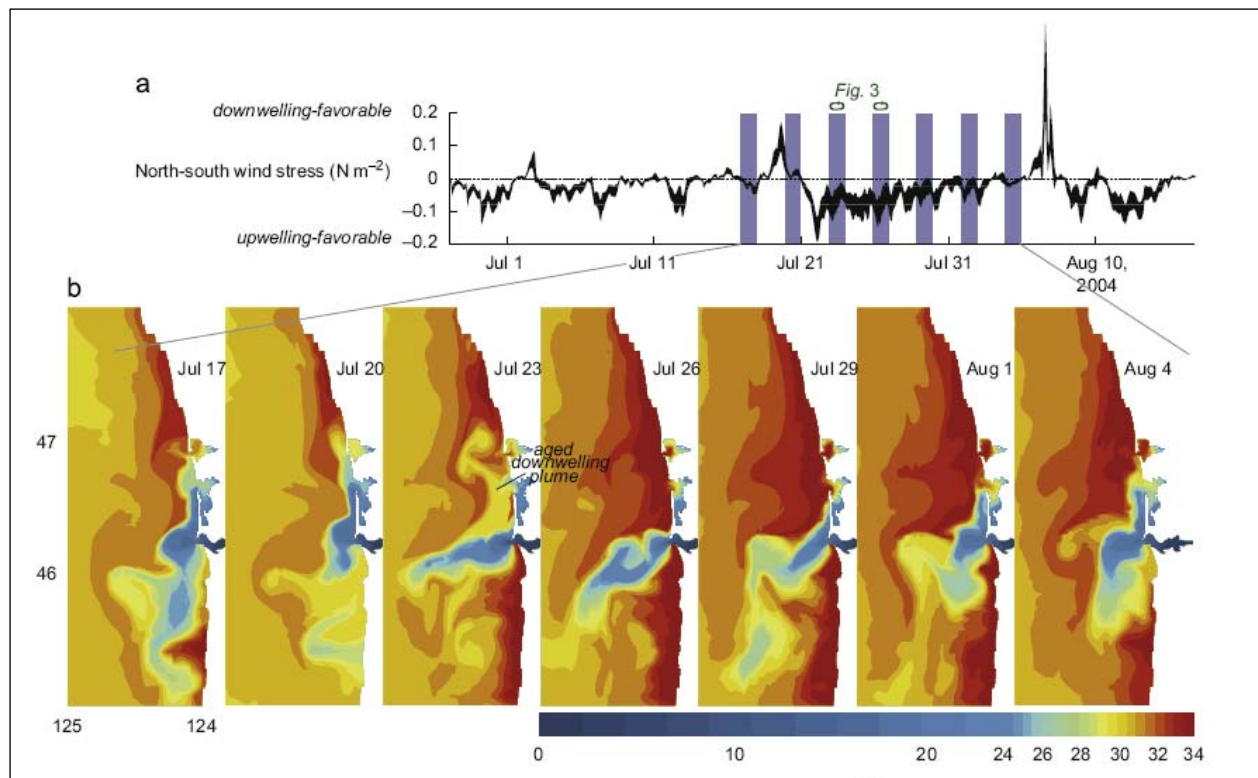

Figure 1.36. a) North-south wind forcing during July and early August 2004. The width of the black line indicates one standard deviation in wind stress over the model domain. Blue bars mark the 25-hour averages shown in (b). (b) Model surface salinity.

From Banas et al. (2008).

1.3.3 Water Properties

The subtidal fluctuations of water properties in the eastern Pacific are driven primarily by synoptic meteorological events (Largier et al. 1993). The surface water properties respond quickly to the upwelling/relaxation cycle of the winds. During upwelling-favorable winds, deeper waters are brought to the surface over the inner and midshelf and warmer, fresher waters are pushed offshore. With extended upwelling-favorable winds the surface waters move offshore and shelf residence time is short.

During relaxation winds the upwelling stops and the less dense water moves toward the shore (Roughan et al. 2006; Gough 2008). The waters can remain relatively stationary or move either poleward or equatorward. During relaxation events shelf residence time can be much longer than during upwelling events and strong phytoplankton blooms can develop over the shelf.

As noted in [Section 1.3.1](#), Largier et al. (1993) characterized the subtidal spectra into three different bands: low frequency bands corresponding to synoptic wind patterns; very low frequency (VLF) bands, with periods of weeks to months; and annual bands, which are due to seasonal cycles. The VLF band was found to be associated with alongshore variations in oceanic mesoscale forcing and not due to wind forcing. The VLF response can be attributed to a number of mechanisms, including the onshore movement of CC waters during the relaxation period (Rosenfeld 1988), the presence of a deepened warm surface layer associated with El Niño-produced Kelvin waves along the coast (Ramp et al. 1997), and changes in the large-scale barotropic pressure field (Largier et al. 1993).

1.4 TIDAL AND SUPRATIDAL FLUCTUATIONS

The tides are the periodic raising and lowering of the sea's surface created by the gravitational pull of both the sun and the moon, along with the centrifugal forces of the earth/moon and earth/sun rotating systems. Because the orbits of the moon around the earth and the earth around the sun are both elliptical and at a declination, the potential of the tide-producing forces at a specified location on earth's surface encompasses many frequencies with different magnitudes. Each of these frequencies is labeled as a tidal constituent. Approximately 380 frequencies have been identified, although most can be ignored since either their amplitudes are insignificant or their frequencies are high. The two dominant tidal constituents along the Northern Study Area are the M_2 principal lunar semidiurnal and K_1 luni-solar diurnal.

The change in sea level associated with the tides acts like a shallow water wave propagating over the ocean basins, since its wavelength is on the order of thousands of kilometers. These “tidal” waves are refracted by the sea floor and constrained by the continents. The result is a complex tidal system called the “amphidromic system.” An amphidrome is a point where the tidal amplitude is zero and the tidal wave rotates around this point with the amplitude increasing with distance from the amphidrome. There is a separate amphidromic system for each tidal constituent. In the North Pacific Coast there are semidiurnal and diurnal amphidromes associated with the M_2 and K_1 constituents (Luther and Wunsch 1975). Both the M_2 and K_1 tides move as barotropic Kelvin waves around the amphidrome in a counterclockwise direction so that they propagate from south to north along the West Coast of North America. For other constituents the amphidrome can be located in different locations and the tidal propagation can be either clockwise or counterclockwise. Tidal waves act like shallow water waves in that a particle of water on the surface of the ocean follows a vertically oriented elliptical path – when the crest of the wave passes over a fixed location the particle moves forward and when the trough of the wave passes the particle regresses. The particle of water also has a component of motion perpendicular to the direction of the propagating wave, so that it traces out a horizontal ellipse. The resulting sea surface motions are the tidal currents. The elliptical patterns traced by tidal motions are different from the “tidal ellipses” mentioned in the literature. A tidal ellipse is the ellipse traced out by the vector describing the tidal motion.

The K_1 and M_2 amplitudes increase from south to north along the northwest coast. The amplitudes can range from roughly 50 to 70 cm off California and from 80 to 100 cm off Washington. The M_2 global amphidromic system is depicted below (Figure 1.37).

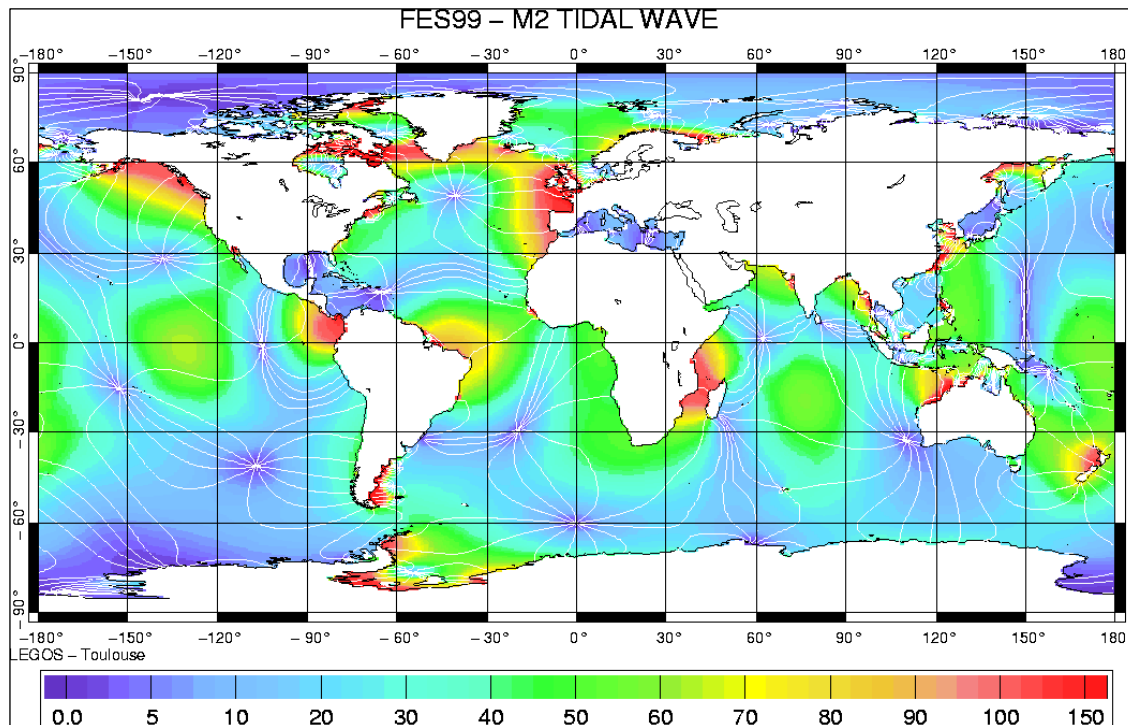

Figure 1.37. Amplitudes of the M_2 tidal constituent (in centimeters) derived from the FES99 model.

Cotidal lines indicating phase every 30 degrees originate at amphidromic points where the tidal range is zero.

From Legos (<http://www.legos.obs-mip.fr>)

Sparsely arrayed Coastal Ocean Dynamics Experiment (CODE) current measurements at various depths between 75 and 3,000 m were used to perform a tidal analysis over the slope and basin of the Northern California coast (Noble et al. 1987). The M_2 constituent had the strongest amplitudes of all constituents and usually contained 50-75 percent of the tidal variance. The barotropic M_2 variance was usually over 50 percent, which suggests the barotropic M_2 currents were larger than the baroclinic M_2 currents. The exception to this was over the middle slope, where the M_2 barotropic variance dropped below 50 percent. This suggests that the M_2 currents over the middle slope were dominated by baroclinic currents (i.e. internal tidal currents). The semimajor axis of the M_2 tidal velocity ellipse measured between 2 and 4 cm/s and was typically aligned with the topography, although there was significant spatial and temporal variability. This variability was believed to be caused by perturbations in the M_2 barotropic tide acting as a coastally trapped Kelvin-like wave affected by variations in the coastal boundary as it propagated poleward. At the continental slope and ocean basin, the M_2 tidal ellipses were uniform and vertically in phase. Diurnal phases of current ellipses, such as the barotropic K_1 , were uniform over the basin but changed dramatically over the slope. These diurnal (K_1) ellipses

were narrow and rotated counterclockwise over the basin and upper slope. Diurnal currents over the middle slope and middle depths had ellipses that rotated clockwise and had variable phase shifts. Ellipse magnitudes associated with the diurnal constituents were between 0.7 and 1.2 cm/s. These diurnal barotropic currents propagate poleward as a combination of Kelvin and continental shelf waves trapped along the coast.

The interaction of Kelvin and continental shelf waves with the continental shelf can be very complex. Modeled Kelvin waves along the Oregon coast showed linearly polarized ellipses in deep water and dominantly counterclockwise ellipses over the continental shelf (Erofeeva et al. 2003) (Figure 1.38). Shelf waves, on the other hand, are restricted to the continental shelf and display a clockwise rotation. Erofeeva et al. (2003) suggested that enhanced diurnal currents near the Heceta-Stonewall Bank Complex are primarily due to a topographic shelf wave on the descending part of the dispersion curve. Most of the continental shelf along the Oregon coast is too narrow to support barotropic shelf waves at diurnal frequencies, although there are regions where the shelf widens and the slope increases enough to allow them. Seasonal variations in ocean conditions can have a significant effect on tidal shelf currents. This is due to differences in stratification between seasons. Summer is typically more stratified and displayed a strong and variable influence from internal tides.

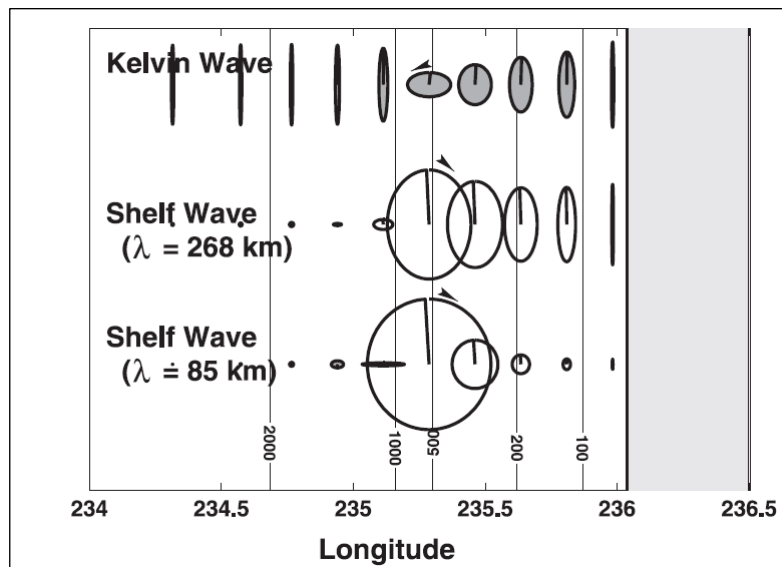

Figure 1.38. Velocity ellipses for the two barotropic shelf waves permitted for the Heceta Bank profile at the K_1 frequency along with ellipses for the (shelf-modified) Kelvin wave (top).

Shading corresponds to counterclockwise (CCW) tidal ellipse rotation. Depths for the cross section are contoured.

From Erofeva (2003).

HF-radar-determined tidal ellipses in the Bodega Bay region for diurnal constituents K_1 , P_1 , and O_1 were found to rotate clockwise, although near Pt. Reyes the O_1 switched and rotated

counterclockwise (Kaplan et al. 2005) ([Figure 1.39](#)). The P_1 and K_1 ellipses exhibit complex spatial structures in direction and amplitude. K_1 ellipse amplitudes (tidal current amplitudes) ranged from about 0.2 cm/s to 5 cm/s. Noble et al. (1987) observed similar variability in the K_1 ellipse properties but observed amplitudes of 0.7 to 1.2 cm/s using data from a sparse array of ADCP instruments. The M_2 tidal ellipses tend to be aligned with the bathymetry and coastline (Kaplan et al. 2005) and M_2 tidal currents typically have amplitudes between 2 cm/s and 5 cm/s (Noble et al. 1987; Kaplan et al. 2005). Kaplan et al. (2005) also found a striking switch in rotational orientation of the M_2 ellipses at the continental shelf break, where rotation was clockwise over the shelf and counterclockwise over the slope ([Figure 1.39](#)). This change in polarization of the M_2 was attributed to the propagation of internal tidal waves away from the shelf break. According to amphidromic maps of M_2 ([Figure 1.37](#)) and K_1 tides, the K_1 and M_2 tides should have higher tidal current amplitudes in the northern regions of the Northern Study Area.

The tidal variance (percentage of the currents due to tides) along the northwest coast is typically between 2 percent and 8 percent (Noble et al. 1987; Kaplan et al. 2005). An exception to this is off the coast of bays and estuaries, where tidal pulses can create strong tidal currents that extend sea-ward. Regions along the northwest coast that have the strongest tidal influence on coastal currents are offshore from the Strait of Juan de Fuca, offshore of the Columbia River mouth, and in the Gulf of the Farallones (offshore of the mouth of the San Francisco Bay). In the Gulf of the Farallones, contours of tidal variance are bulls-eyed around the mouth of the San Francisco Bay (Gough 2008) ([Figure 1.40](#)). The spatial pattern of the tidal variance reflects the the K_1 and M_2 current amplitudes, which reached 10 to 13 cm/s. In the Gulf of the Farallones, tidal variances (percentage of the current due to tides) of over 50 percent were recorded along the inner shelf and are probably much higher at the mouth of the bay. Similar spatial patterns in the tidal variance can be expected off the Strait of Juan de Fuca and the Columbia River mouth.

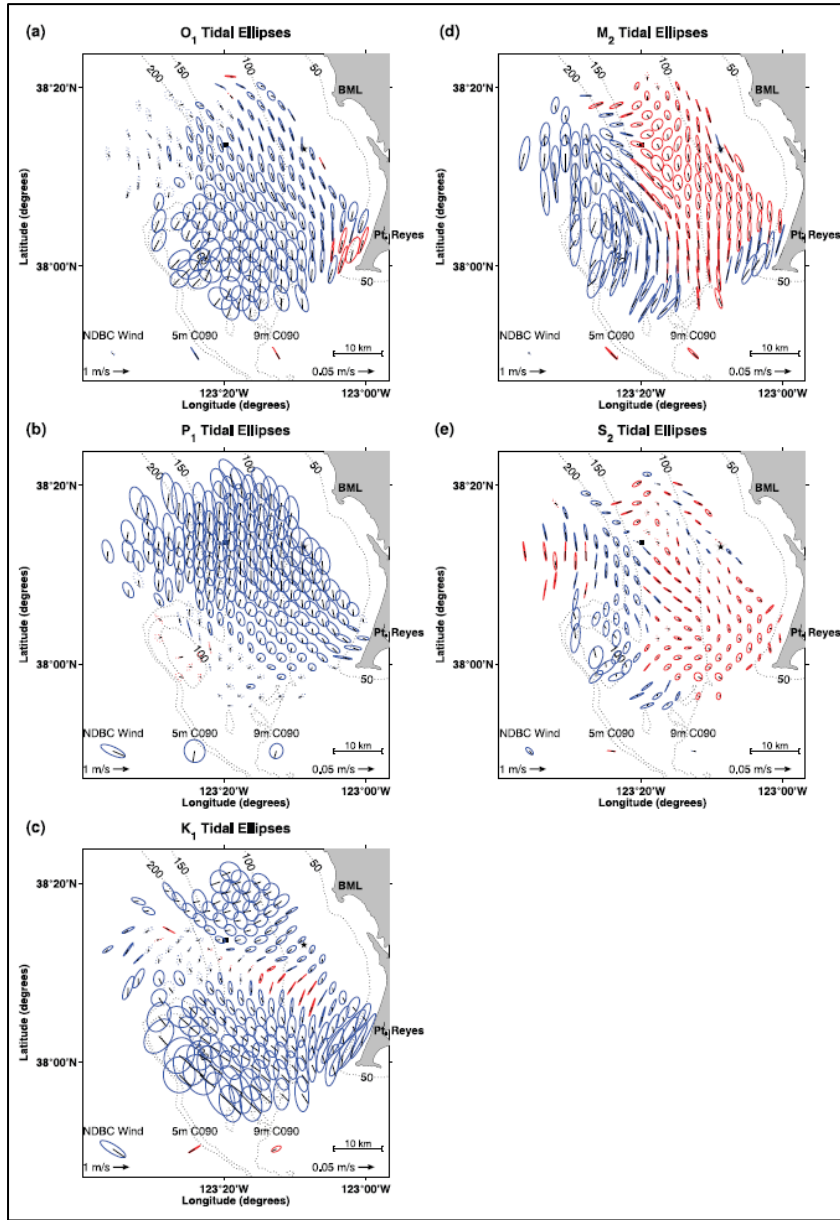

Figure 1.39. Tidal ellipses at (a) O_1 , (b) P_1 , (c) K_1 , (d) M_2 , and (e) S_2 frequencies. Clockwise rotation ellipses are shown in blue, and counterclockwise ellipses are in red.

Black lines emanating from the center of each ellipse denote flow direction at the time of greatest tidal flow in that harmonic from ADCP data at 9 m. For clarity, only half the HF radar grid points are shown. Tidal ellipses from NDBC wind data (the location of which is indicated by a black square) and 5-m and 9-m ADCP data (indicated by a black, five-point star) are shown at the bottom of each panel. Dashed lines are used for tidal ellipses that have a signal-to-noise ratio less than 1.

From Kaplan et al. (2005).

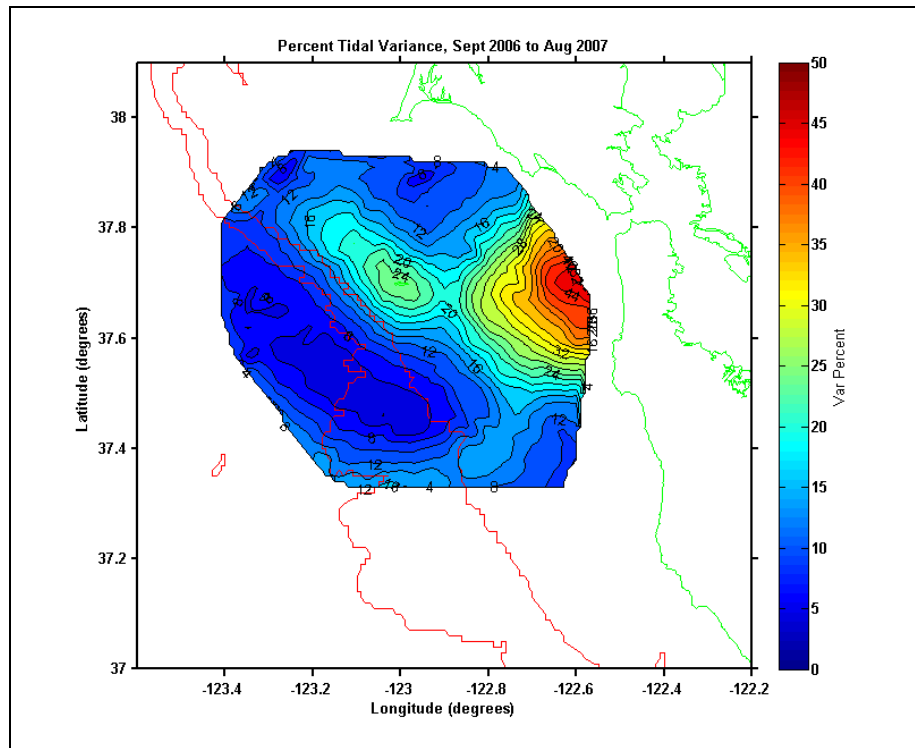

Figure 1.40. Contours of percent tidal variance in the Gulf of the Farallones for September 2006 - August 2007.

From Gough (2008).

1.5 INTERANNUAL FLUCTUATIONS

In the last couple decades there have been an increased number of publications on large-scale interannual climatic fluctuations. Observations of these fluctuations have been made possible by the growing length of data sets that are now able to resolve long-period (decadal or longer) oscillations. The advent of new technologies such as remote satellite sensing and increased interest in climatology due to global warming has also aided the progress toward understanding these fluctuations. Still, evidence of some fluctuations is weak. The periods of many climatic fluctuations that have been observed are on the order of multiple decades, which are still difficult to resolve. Many of the oscillations are statistically derived and their dynamics are often not completely understood.

The interannual fluctuations that are covered in this section and affect the Northern Study Area are the El Niño Southern Oscillation (ENSO), La Niña Southern Oscillation, Pacific Decadal Oscillation (PDO), and the North Pacific Gyre Oscillation (NPGO). Since these oscillations effect seasonal variability, they are also covered in [Section 1.2](#), Seasonal Patterns. A number of indices are used to identify interannual fluctuations. These indices use a combination of atmospheric and oceanographic observations such as sea surface temperature (SST), atmospheric sea level pressure (SLP), upper atmospheric pressure, sea level, precipitation, and wind patterns.

The most commonly used climatic indices are the Multivariate ENSO Index (MEI, [Figure 1.41](#)), Southern Oscillation Index (SOI) and the North Pacific Index (NPI). The MEI is used in correspondence with the ENSO and the NPI is used in correspondence with the PDO. As new data are collected and new analyses performed, more oscillations and indices are being discovered and presented in the literature. This section concentrates on only the predominant and widely accepted oscillations and indices.

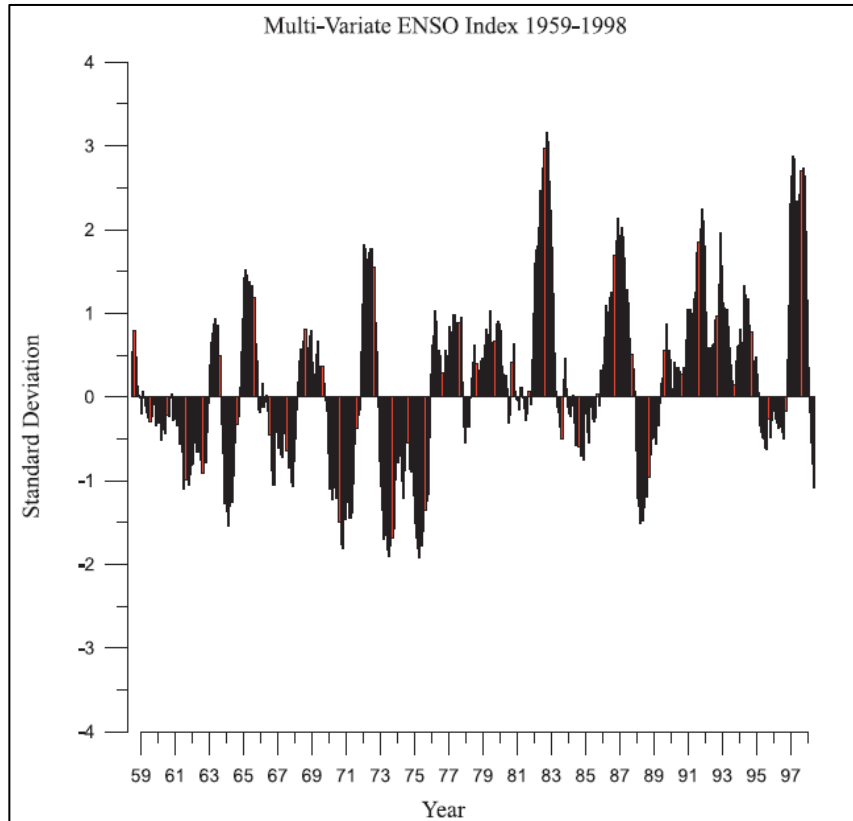

Figure 1.41. Multivariate ENSO Index from 1959-1998.

Positive (negative) standard deviations indicate El Niño (La Niña).

From Shinker and Bartlein (2009).

The National Climatic Data Center (NCDC) maintains an extensive resource on global and local climatology that is available to the public (<http://www.ncdc.noaa.gov>). Among the many resources available are up-to-date monitoring of ENSO, teleconnection indices, SST, reports, and discussions. Archived climatic data is also available.

The literature often uses the term “teleconnections,” which refers to the concept that climate anomalies in one location may be related to the climate in distant locations through the occurrence of particular global-scale anomalies in atmospheric circulation (Shinker and Bartlein 2009) (Redmond and Koch 1991). Redmond and Koch (1991) identified two teleconnection

patterns, the Southern Oscillation and the Pacific-North America (PNA). The PNA has been observed as one of the dominant teleconnection modes and its upper-level atmospheric pattern consists of a deeper-than-usual Aleutian Low pressure center, an intensified ridge of high pressure over western North America, and a negative pressure anomaly at upper levels over the southeastern United States.

The ENSO is the occasional appearance of warm water off the coast of Peru (Wyrtki 1975). The arrival of these warm waters is due to the relaxation of typically persistent tropical easterly winds, which causes an eastward propagation of warm waters acting as an equatorially trapped Kelvin wave. In addition to the equatorial east Pacific, El Niños have a large-scale influence on the entire Pacific Ocean, including the northwest coast of North America. Strong El Niños are associated with anomalous heavy precipitation along the California and southern Oregon coasts and anomalous low precipitation along the Washington coast. Based on the Multivariate ENSO Index (MEI) ([Figure 1.41](#)) the five strongest El Niños in order of strength are 1982-83, 1997-98, 1991-92, 1986-87, and 1972-73 (Shinker and Bartlein 2009). The strongest La Niñas in order of strength are 1974-75, 1971-72, 1988-89, 1964-65, and 1962-63. In the Northern Study Area, sea surface temperatures and temperatures over land are generally higher during El Niño years. Warmer sea surface temperatures are partially due to northward-propagating, coastally trapped Kelvin waves (Meyers et al. 1998). Warmer temperatures over land are influenced by the warmer sea surface temperatures along with a lower latitude storm track that entrains warmer and moister subtropical air.

Shinker and Bartlein (2009) used time-series maps of the following variations in the large-scale climatic controls and surface responses during strong positive (El Niño) and negative (La Niña) phase ENSO events to assess variations in climate anomalies: temperature, mean sea level pressure, 500-mbar geopotential heights, 500-mbar Omega (vertical velocities), and 850-mbar specific humidity. [Figure 1.42](#) shows composite anomalous mean sea level pressure for strong positive and negative ENSO events. Typically, the surface North Pacific High pressure center expands during summer months. During El Niño years, lower-than-normal high surface pressure is found over the eastern North Pacific, particularly during winter months (Shinker and Bartlein 2009) ([Figure 1.42](#)). This reflects the increased intensity and drop in latitude of the storm track, which cause a decrease in upwelling-favorable winds off the California coast and an increase downwelling-favorable winds off the Washington coast. In contrast, La Niña years show anomalously high pressure over the eastern North Pacific, which would increase upwelling-favorable winds and cool sea surface temperatures.

Mean 500-mbar geopotential heights charts show the strength of the trough and ridge patterns in the upper atmosphere (not pictured). This helps determine the position and strength of the jet stream. The jet stream is typically associated with the storm track. A deepening and expansion of the trough in the North Pacific basin occurs during December through March of El Niño years (Shinker and Bartlein 2009). The deepening of the trough is indicative of intensification of storms and the expansion of the trough is indicative of a more southerly track of the jet stream.

The 500-mbar level is often referred to as the “level of nondivergence.” It is here that flow is generally geostrophic and vertical velocities can be inferred from surface and upper-level

divergence fields. Large-scale rising motions in the atmosphere (positive 500-mbar Omega) are associated with precipitation, whereas sinking motion suppresses precipitation. Although 500-mbar Omega values do not show a strong contrast between El Niño and La Niña years, there is evidence of weak vertical velocities north of the mid-Pacific basin which account for the relatively dry climate off Washington during El Niños (Shinker and Bartlein 2009). Vertical velocities during La Niñas did not have a strong coherent structure. Mean 850-mbar relative humidity can be used along with mean vertical velocity to highlight precipitation trends. During El Niños there is typically a band of 850-mbar high relative humidity that is brought from the southwest over the Pacific toward the northwest coast (Shinker and Bartlein 2009). Early in the El Niño winter, however, there is anomalously low relative humidity off the Washington coast.

The PDO has been described as a long-lived El Niño-like pattern of the Pacific climate variability and as a blend of two sometimes-independent modes having distinct spatial and temporal characteristics of sea surface temperature in the North Pacific (Mantua and Hare 2002). Mantua and Hare (2002) report that several studies have found two “cool” PDO regimes, which occurred from 1890-1924 and 1947-1976, and two “warm” PDO regimes, which occurred from 1925-1946 and 1977-1995. The bottom of [Figure 1.43](#) shows average PDO Index values and the general shape of the oscillation. During warm PDO phases, sea surface temperatures (SST) tend to be anomalously cool in the central North Pacific, while anomalously warm SST occurs along the West Coast of North America ([Figure 1.43](#)). Mean sea level pressure (SLP) and wind stress anomalies during the winter of warm PDO show a stronger low pressure signal along with enhanced cyclonic circulation. This is due to increased intensity or increased frequency of low-pressure midlatitude cyclonic storms.

The climatic anomalies associated with the PDO are similar to those associated with the ENSO, although not as extreme. Warm phases of the PDO coincide with anomalously dry periods along the Washington coast and across the northern Great Plains, and wet periods along the California and Alaska coast. Warm phase PDO temperature anomalies show warm temperatures along the West Coast that increase toward Alaska.

As mentioned by Mantua and Hare (2002), there is compelling evidence for connections between the PDO and Pacific marine ecosystems. Studies have documented a strong jump in groundfish stocks coincident with the 1976-77 regime shift, Pacific halibut recruitment has been shown to undergo interdecadal shifts correlated with PDO, and several flatfish species exhibit recruitment frequencies similar to that of the PDO.

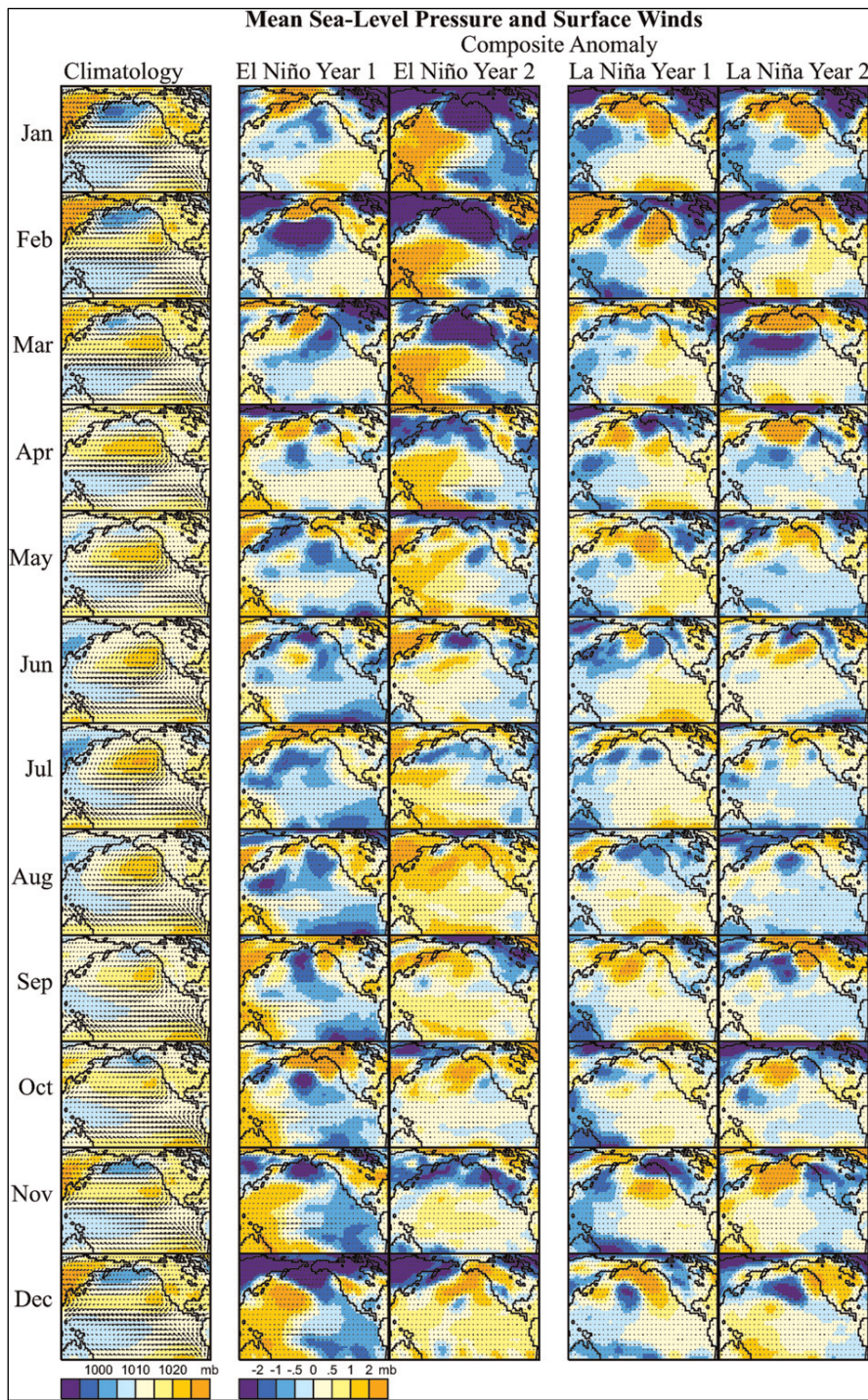

Figure 1.42. Mean sea level pressure with surface wind vectors climatology and composite-anomaly maps for El Niño and La Niña years. Base period 1959-97.

Blue (orange) indicates low (high) sea level pressure in the climatology column and anomalously low (high) sea level pressure in the El Niño and La Niña columns.

From Shinker and Bartlein (2009).

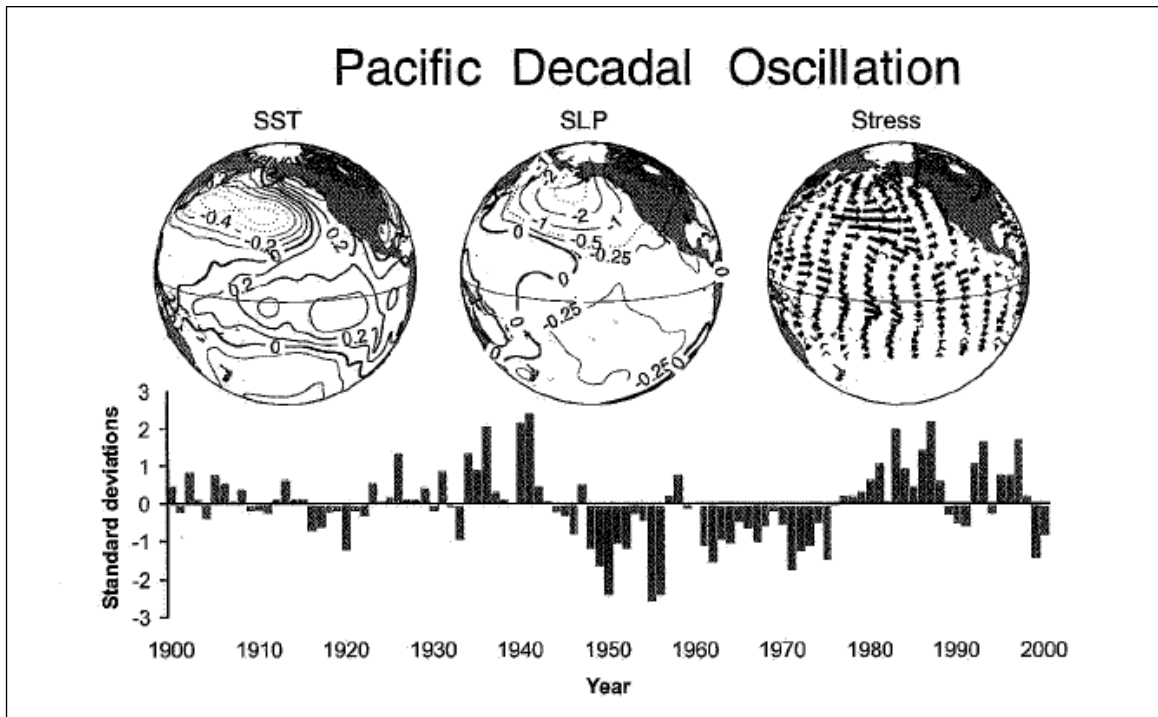

Figure 1.43. (top) Anomalous climate conditions associated with warm phase PDO, and (bottom) November-March average values of the PDO Index. Values shown are °C for SST, millibars for SLP, and direction and intensity of wind stress. The longest vectors for wind stress represent a pseudostress of $10 \text{ m}^2/\text{s}^1$.

From Mantua and Hare (2002).

The PDO and ENSO have not been able to explain all fluctuations along the northwest coast. The North Pacific Gyre Oscillation (NPGO) has recently been found to correlate with previously unexplained fluctuations in salinity, nutrients, chlorophyll, and fish populations (Di Lorenzo et al. 2008). The NPGO is the second mode of the sea surface height (SSH) variability (i.e. the second empirical orthogonal function (EOF) of SSH) in the northeast Pacific. The NPGO resembles the second EOF mode of the North Pacific SST, but is the dominant mode for salinity and nutrients.

The first mode of the positive PDO shows a large cyclonic gyre in the North Pacific, which reflects downwelling-favorable winds along the northwest coast ([Figure 1.44](#)). This pattern does not explain the upwelling-favorable conditions observed along the California coast. The positive NPGO, however, manifests two gyres, a cyclonic gyre to the north and an anticyclonic gyre to the south ([Figure 1.44](#)). This acts to increase the transport of the Alaskan Coastal Current and the California Current. The upwelling-favorable pattern of the positive NPGO implies that latitudes south of lat. 38° N along the California coast could exhibit strong biological productivity due to upwelling-favorable winds, despite the appearance of positive PDO patterns, which are associated with low productivity.

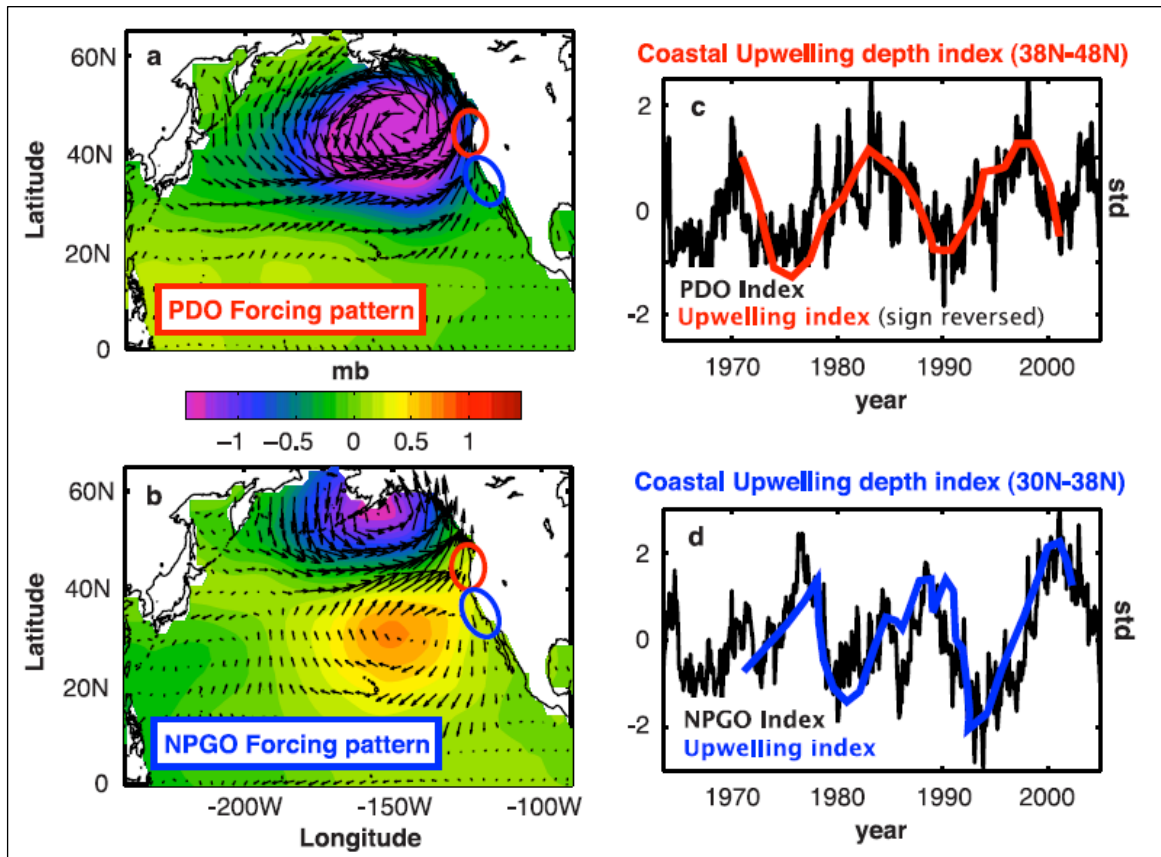

Figure 1.44. Atmospheric forcing patterns of the PDO and NPGO modulate decadal changes in coastal upwelling.

Regression maps of (a) PDO and (b) NPGO indices with NCEP wind stress vectors and sea level pressure (color scale). (c) Coastal upwelling depth index from inverse model calculations averaged from lat. 38° N to lat. 48° N (area denoted by red circles) compared to PDO index. (d) Coastal upwelling depth index from inverse model calculations averaged from lat. 30° N to lat. 38° N (area denoted by blue circles) compared to NPGO index. A positive upwelling index indicates a deeper upwelling cell.

From Di Lorenzo et al. (2008).

1.6 WAVE CLIMATE

Wave characteristics along the Northern Study Area of the United States depend on weather patterns, geographic effects, storm climatology, coastline orientation, and local bathymetry. The available wave power is considerable and there is a potential to meet a significant portion of total power needs. According to the California Energy Commission (PIER 2007), there is a “theoretical potential” of 38 gigawatts with an estimated “technical potential” of about 7 to 8 gigawatts. The technical potential is about one-fourth of California’s power needs. The extent to which wave energy conversion (WEC) devices will be able to harness the technical potential of ocean waves along the coast will depend on technological, environmental, economic, social, and legal limitations.

There are numerous wave monitoring and statistic resources available to the public. The National Data Buoy Center (NDBC, <http://www.ndbc.noaa.gov>), which is run by the National Oceanic and Atmospheric Administration (NOAA) and the Coastal Data Information Program (CDIP, <http://cdip.ucsd.edu>) provide the two largest inventories of archived buoy-recorded wave data. There are approximately 30 NDBC and 80 CDIP stations along the West Coast. Systematic differences between NDBC and CDIP buoy readings show that NDBC buoys read higher wave heights by about 8 percent (Tillotson and Komar 1997).

Most of the CDIP buoys are specifically designed for collecting wave data and are an excellent source for directional wave data. Most do not provide meteorological data, although some do. There are a number of products available on the CDIP website, including a selection of archived data formats, interactive plots, and coastal wave model outputs. The coastal wave model outputs provide wave energy spectra diagrams along with the predominant wave height and wave period. The swell model is based on wave diffraction-refraction simulations using code developed by Jim Kirby (University of Delaware), Eloi Melo (Santa Catarina Federal University), and Bill O'Reilly (Scripps) (<http://cdip.ucsd.edu>). An example of the CDIP wave model output is provided below ([Figure 1.45](#)). It is important to note water depth at buoy locations when analyzing wave data as wave height and direction for long-period swells are affected by bottom bathymetry at water depths of 300 m or less.

NDBC buoys are designed to collect meteorological data along with oceanographic data and are therefore not specifically designed for recording wave data. Only select NDBC buoys collect directional wave data. There are also several satellite-borne altimeter instruments that are used to record wave data. The Topex/Poseidon satellite has been operational since 1992 and the Jason-1 satellite has been operational since 2001. Data from altimeters on both of these satellites have been compared to buoy and wave model data (Scott 2005).

There are three wave model outputs that are available to the public: Wave Watch III, CDIP, and LOLA. The Wave Watch III (WW III) model Tolman (2009) outputs are available through the U.S. Navy (<https://www.fnmoc.navy.mil/public>) and NOAA (<http://polar.ncep.noaa.gov>). WW III global and regional wave model outputs provide information on significant wave height, swell wave height, wind wave height, peak wave period, secondary wave period, swell wave period, wind wave period, and whitecap probability. The CDIP coastal wave model is based on wave diffraction-refraction simulations. Real-time and archived CDIP buoy model outputs like those in [Figure 1.45](#) are available on the CDIP website. CDIP is currently developing a wave model prediction database. The LOLA wave model is a coastal wave model that is available on the popular surf website www.surfline.com. Since the wave energy resource will vary along the coast due to variations in the bathymetry and coastline and since there are areas where buoy concentrations are low, sophisticated nonlinear wave models (Janssen et al. 2006) may prove to be very useful in wave energy assessment (Largier 2008).

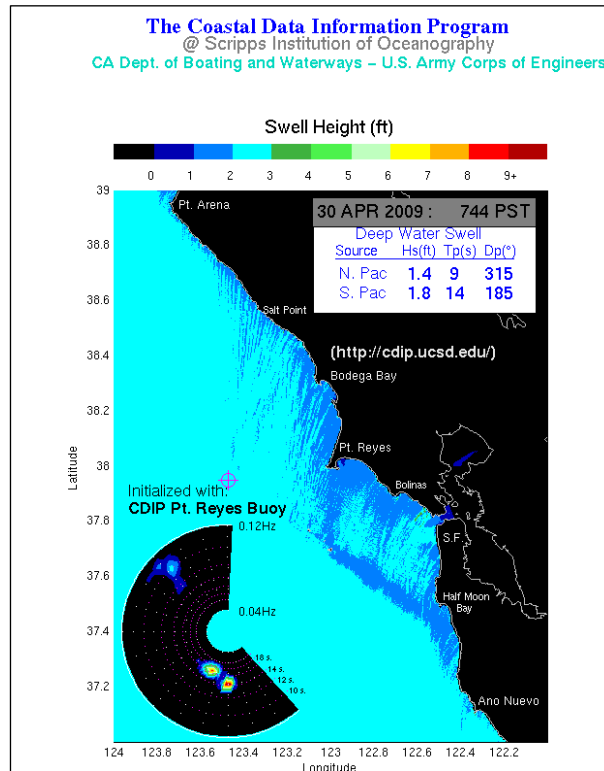

Figure 1.45. CDIP coastal nowcast spectral model output courtesy CDIP, Scripps Institution of Oceanography.

Similar nowcast plots are currently not available for the Grays Harbor, WA, or offshore Umpqua, OR, CDIP stations.

Littoral processes and sediment transport are strongly affected by breaking wave heights and incident wave angles along the shoreline. Typically, waves approaching the coastline from the north will drive an inshore southward current along the West Coast and waves approaching from the south will drive an inshore northward current. Depending on how approaching deepwater waves are refracted as they approach shallower waters over the continental shelf and how the coastline blocks waves from certain angles, there can be considerable differences in the transport of material in the littoral zone. There is also evidence that transport in the littoral zone can significantly vary from year to year due to wave climate variances (Allen and Komar 2006). This is further explained in [Section 1.6.3](#), Connection with Littoral Processes and Sediment Transport.

The distribution of wave power in Northern California averages about 30 kW/m and peaks to over 1,000 kW/m during storms (Behrens et al. 2008). Wave height, which is directly proportional wave power density E and wave power flux F , is highly variable both seasonally and daily. A distribution of significant wave height is shown below ([Figure 1.46](#)) from the Point Reyes CDIP buoy for the years 2004 - 2007. Significant wave heights less than 0.75 m are very rare, the distribution increases rapidly to the peak at about 2 m, and significant wave heights

greater than 7 m are rare. Significant wave height and maximum wave height are typically greater along the Washington and Oregon coast than along the California coast ([Figure 1.47](#)).

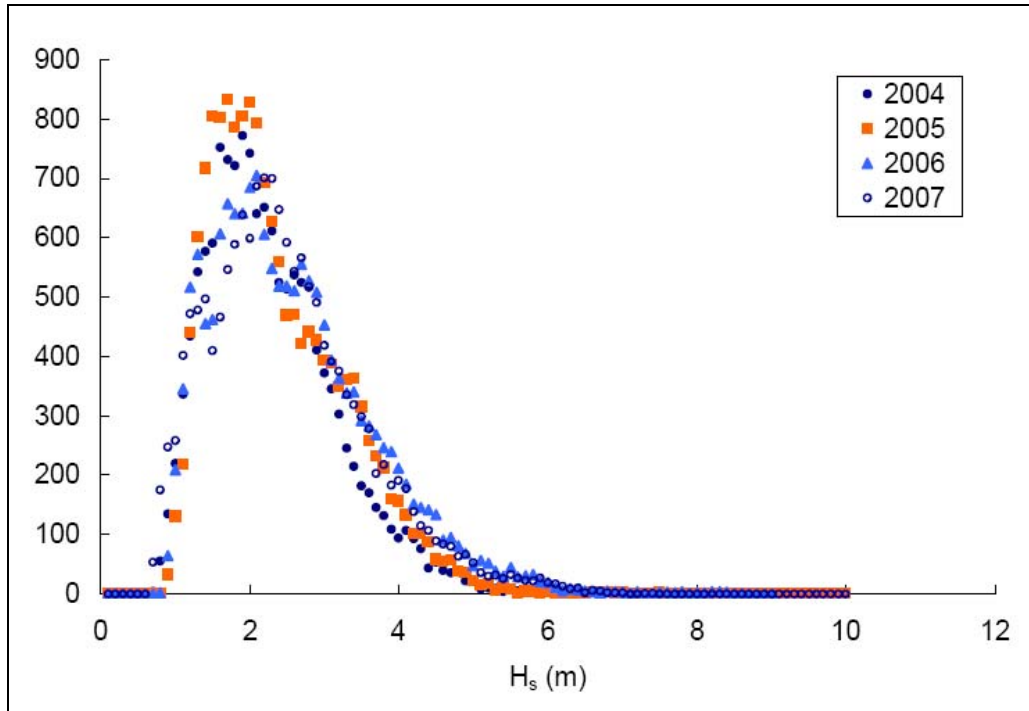

Figure 1.46. The distribution of significant wave height, H_s , for the years 2004 to 2007 at the CDIP Point Reyes Buoy.

Y-axis indicates the number of hourly readings. Wave heights between 1 m and 4 m are most common, corresponding to power of about 100 kW/m or less. The power of the largest waves may be several times 100 kW/m.

From Bedard et al. (2005).

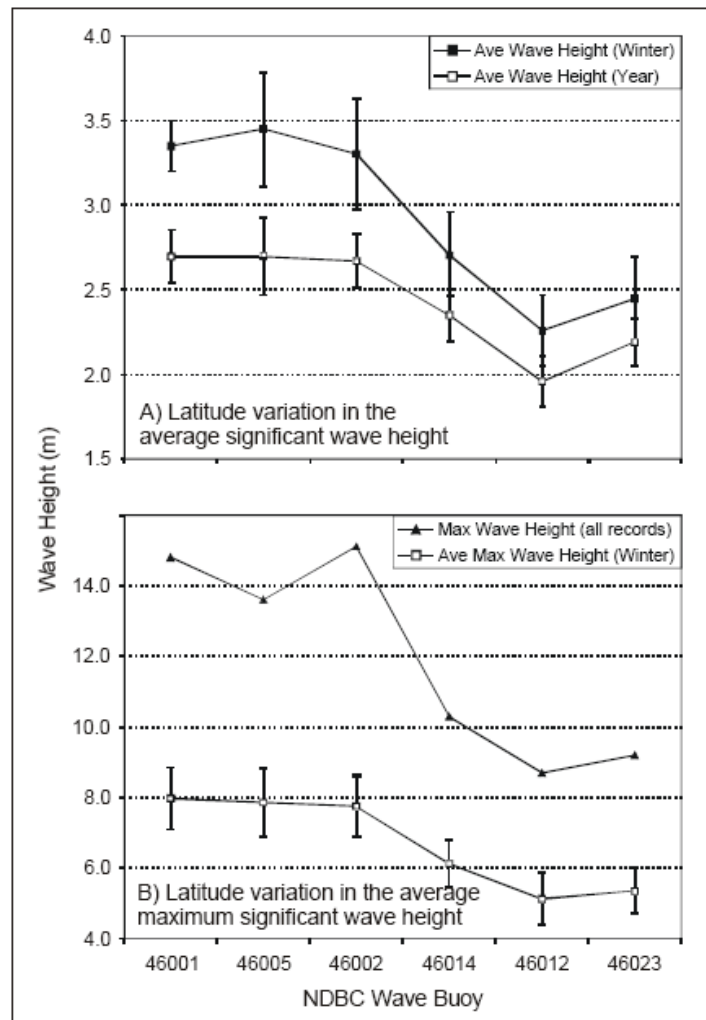

Figure 1.47. Spatial variability of wave heights in the North Pacific: A) Average yearly and winter significant wave heights and B) Average maximum wave heights.

NDBC wave buoys are listed from north to south: Station 46001 is located in the Gulf of Alaska and station 46023 is located off Point Arguello, California.

From Allen and Komar (2000).

1.6.1 Directional Energy Spectrum

The offshore wave climate along the Northern Study Area can be characterized by four regimes (Figure 1.48): Northern Pacific swell, Southern hemisphere swell, northwest wind swell, and locally generated waves (Hapke et al. 2006). Note that Figure 1.48 is based on California buoy data and that along northern regions of the Northern Study Area (i.e. Washington) the Northern Pacific swell comes more from the west direction, because the storm-generating center occurs at latitudes similar to Washington's. Directional differences of significant wave height between

Washington and California can be seen in [Figures 1.49](#) and [1.50](#). Since the winds off the northwest coast of the United States and in the Pacific Ocean are seasonally variable, so are wind-driven sea-surface gravity waves. In general, during the winter a large percentage of the wave energy that reaches the coast is from powerful storms that develop in the northern Pacific. These storm-driven swells arrive at the coast with relatively large wave amplitudes and long wave periods. During the spring, the storms become less frequent and a large percentage of wave energy is derived locally by strong winds along the coast. These locally wind-driven waves have smaller amplitudes and shorter time periods. During the late summer and early fall storms in the North Pacific and winds along the coast are not as frequent or as strong as they are in spring. Therefore, there is less wave energy reaching the coast during this time of year. Between spring and fall occasionally significant swells reach the coast from storms in the South Pacific. Seasonal variability is explained in further detail in [Section 1.6.2](#), Variability Timescales.

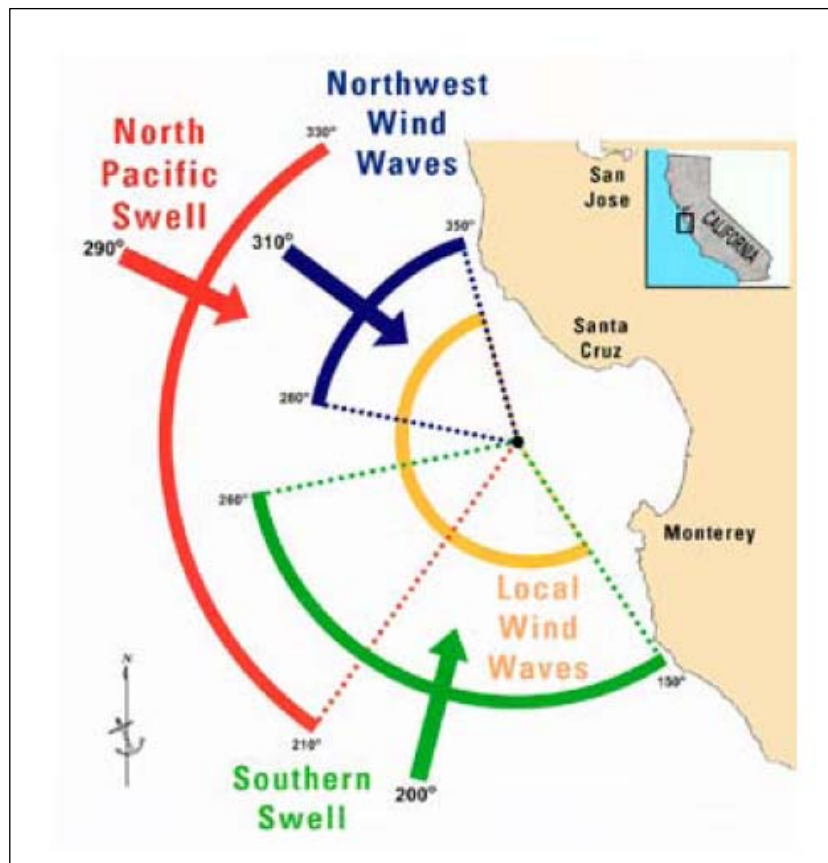

Figure 1.48. General wave directions for California based on offshore buoy data.

Note that North Pacific swells approaching the Washington coast will typically come from a westerly direction.

From Bedard et al. (2005).

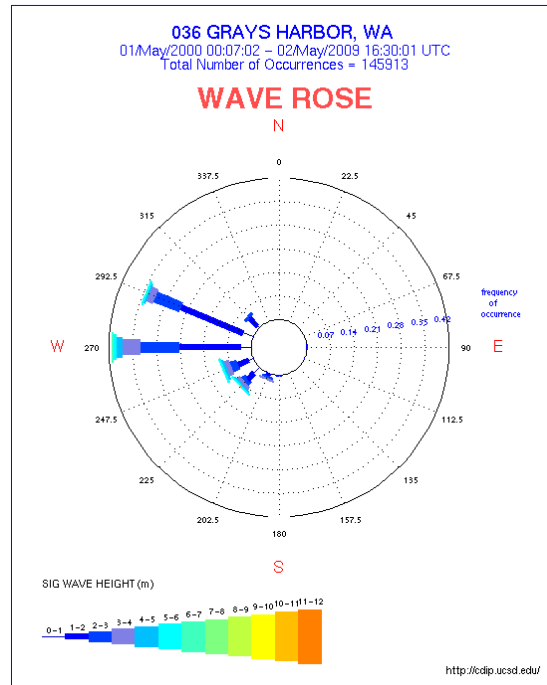

Figure 1.49. Significant wave height wave rose for CDIP buoy 036 Grays Harbor, Washington.

Generated from: <http://cdip.ucsd.edu/>, CDIP, Scripps Institution of Oceanography.

Beyene and Wilson (2006) reported that the wave direction statistics suggest a “two-season” division to the ocean wave year along the Northern California coast. In November through March the dominant wave direction is from the west, with significant energy coming from the northwest. During this time wave heights average above 3 m and dominant wave periods average above 10 s.

The largest waves are observed during the winter following intense, high-latitude storms. A significant portion of wave energy is therefore directed toward northern regions such as Washington from the west and toward southern regions such as California from the northwest. Wave rose plots (Figures 1.49 and 1.50) show that the highest frequency of occurrence of waves of significant height arrives from the west in Washington and from the northwest in Northern California.

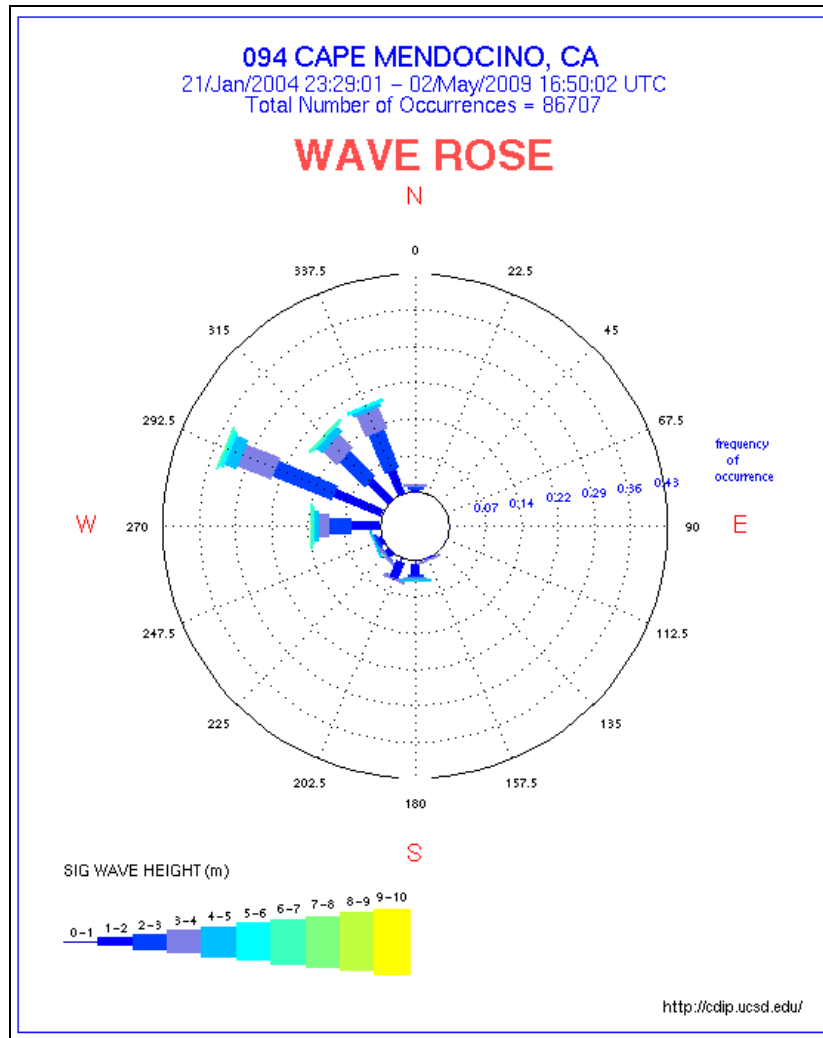

Figure 1.50. Significant wave height wave rose for CDIP buoy 094 Cape Mendocino in Northern California.

Generated from: <http://cdip.ucsd.edu>, CDIP, Scripps Institution of Oceanography.

A cross-shore understanding of directional properties of wave energy propagation as they are refracted near the coast will be important for WEC device placement. As deep ocean waves, and their energy, approach the coast and traverse over shallow waters, they are refracted. Waves from the north and south will typically be refracted so that they arrive perpendicular to the coast.

There is a sparse amount of directional wave energy spectrum information available. This is because buoy technology was not able to accurately measure wave direction along with amplitude and period on a large scale (in the Northern Study Area) until about 10 years ago, when the CDIP buoys began to be deployed. Directional wave energy spectra are definitely an area that will require more research in order to optimize WEC development ([see Section 1.7, Summary and Future Needs](#)).

1.6.2 Variability Timescales

Since winds generate surface gravity waves, any variability in the meteorology, either local or far offshore, will cause variability in the wave climate. There are four easily identifiable wave energy variability timescales reaching the West Coast: Diurnal, storm duration, seasonal, and annual/decadal. In addition, this section reports on the increase in storm-generated waves heights that have been observed on the Northern Study Area over the last 3 decades.

As described in [Section 1.2.1, Winds](#), there is a diurnal variability in both long-shore and cross-shore winds over the inner continental shelf due to local sea-breeze effects. Diurnal winds are short-lived and have a relatively limited fetch. Therefore, they do not generate a large amount of wave energy and the waves usually have small amplitudes and short periods.

The coastal wave environment can be quite different between storm-generated waves far offshore over the North (or South) Pacific Ocean and storm-generated waves directly offshore. Midlatitude North and South Pacific storms generally traverse westward as they follow the upper atmosphere jet stream, can last from a day to over a week, and generate waves along the way. Since the swell from storms generated from far offshore travels thousands of kilometers, the faster-moving, long-period waves separate out from slower-moving, short-period waves and arrive at the coast first. In contrast to storms generated far offshore over the Pacific Ocean, storms that are directly offshore generate swells with wave periods that do not separate out. When these swell reach the coast, the waves are multidirectional, they may be large in amplitude (depending on the strength of the storm), and they have a wide range of periods. These swells typically last only a day or two but can last longer. Daily average wave heights and wave energy show multiple defined peaks between November and May, whereas between June and November wave heights and wave energy are lower and more consistent ([Figure 1.51](#)). The daily average significant wave heights in [Figure 1.51](#) largely reflect the local wind environment ([see section 1.2.1, Winds](#)). During the spring and summer there are persistent winds from the north generating local wind swell that is smaller in amplitude and less variable than the winter swells. The defined peaks between November and May are most likely storm-generated swell.

There is a seasonal trend along the Northern Study Area in both monthly mean and monthly maximum wave heights as represented by observations off the Oregon coast ([Figure 1.52](#)). Although the seasonal trend is fairly representative of the entire Northern Study Area, it should be noted, as mentioned above, that there is an alongshore increase in wave heights corresponding to an increase in latitude along the northwest coast of the United States ([Figure 1.47](#)). Tillotson and Komar (1997) report that mean seasonal wave heights during the summer are 1.25 to 1.75 m and increase to 1.0 to 3.0 m during the winter off the Oregon coast. Winter mean wave heights are influenced by storms, which can generate significant wave heights of over 6 to 7 m. Similar results were observed off Northern California, where the average wave height was found to be greatest between November and February (Hapke et al. 2006). This is when the North Pacific long-period swells impact the coast with amplitudes from 2 to 10 m and periods from 10 to 25 s. For Northern California, Hapke et al. (2006) observed mean wave heights of about 3 m; wave heights exceeded 4 m 20 percent of the time. Mean summer wave heights were about 1.8 m and rarely exceeded 4 m. Storm-driven swells are usually generated closer to the Washington coast

than to the California and Oregon coast. Waves along the Washington coast should therefore have larger amplitudes and shorter periods during the winter.

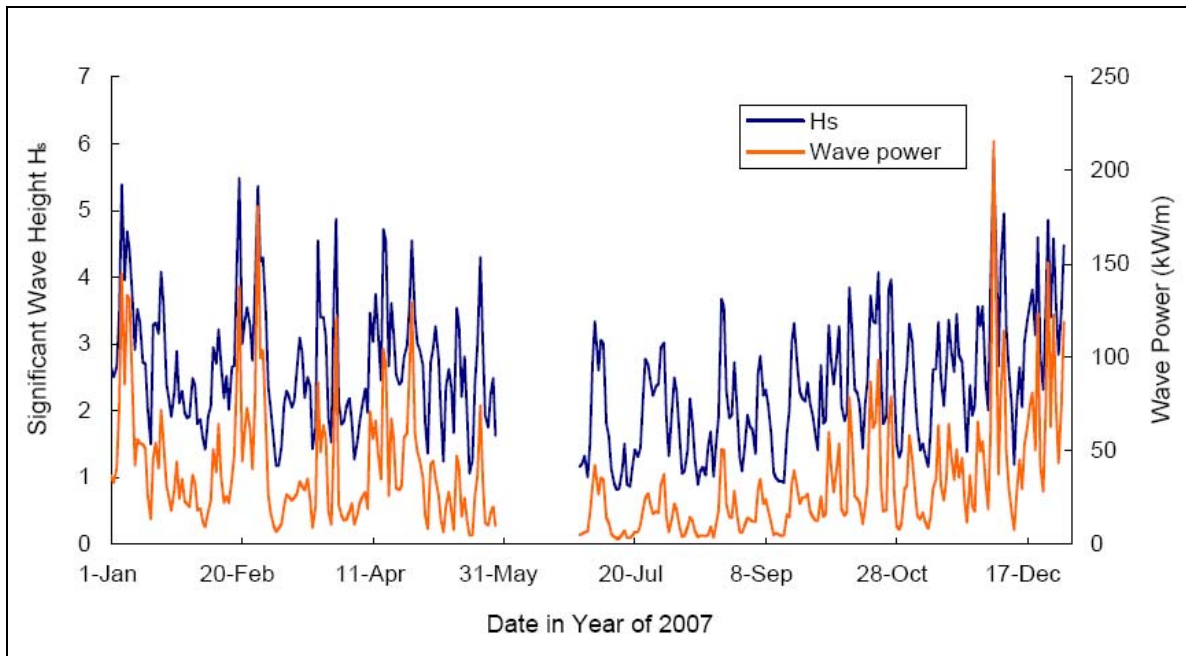

Figure 1.51. Daily average significant wave height H_s in meters (blue line) and wave power in kW/m (orange line) observed at CDIP Point Reyes buoy in 2007.

From Behrens et al. (2008).

The seasonal variation in significant wave height (Figure 1.52) does not perfectly match the seasonal variation in wave energy (Figure 1.53). Reasons for the difference could be differences in buoys, location (Oregon vs. California), time period of data collection or calculation methods. But the difference between Figures 1.52 and 1.53 could be due to the influence of powerful windswells from the northwest driven by persistently strong winds from the north along the Northern Study Area in the spring. This would explain why the energy peak is not until February (wave height peak is in December) and the energy minimum is not until October (wave height minimum is in August). The amount of energy during the spring is underestimated by the significant wave height charts, since the spring windswells have smaller amplitudes than do the periodic, powerful, storm-driven swells during the winter. Windswells have shorter wave periods, causing waves to arrive at the coast more frequently, which means more energy is arriving at the coast. The shift between seasonal variations in wave height and variations in wave energy demonstrates that even though strong storm-driven waves during the winter are typically believed to have the most energy, there is a significant contribution of persistent windswell wave energy off the Northern Study Area during the spring, when southward winds are strongest (see section 1.2.1, Winds). Also, since southward winds are strongest and most persistent off the California and Oregon coast during the spring, windswell wave energy would be expected to be greater off the California and Oregon coast than off the Washington coast.

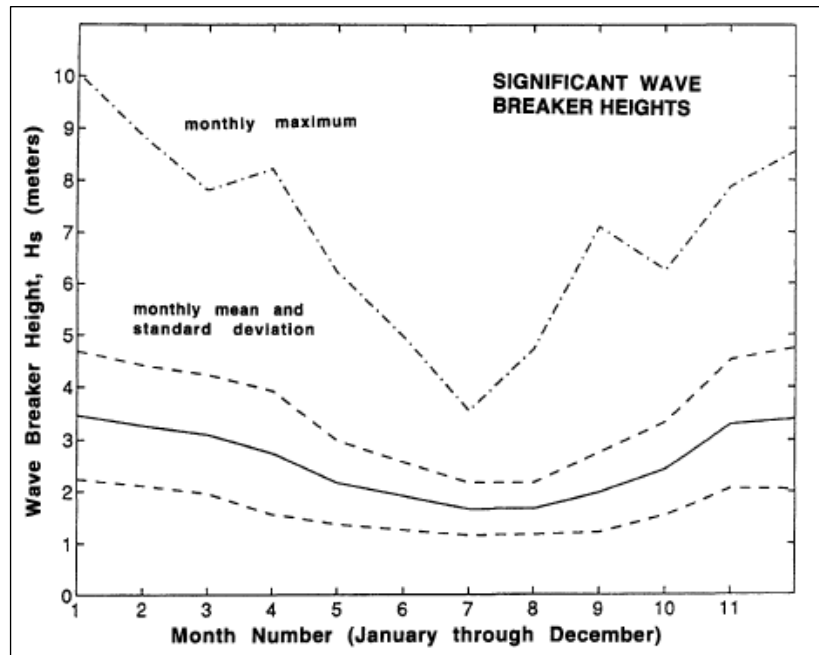

Figure 1.52. Monthly variations in wave breaker heights using deepwater measurements from the CDIP Coquille, Oregon, buoy which began operation in 1981.

The monthly mean values for the 13 years of daily measurements are given by the solid curve, while one standard deviation is given by the dashed curve. The dot-dashed curve represents the monthly maximum breaker heights calculated from the most extreme wave conditions that have been measured by the deepwater buoy.

From Tillotson and Komar (1997).

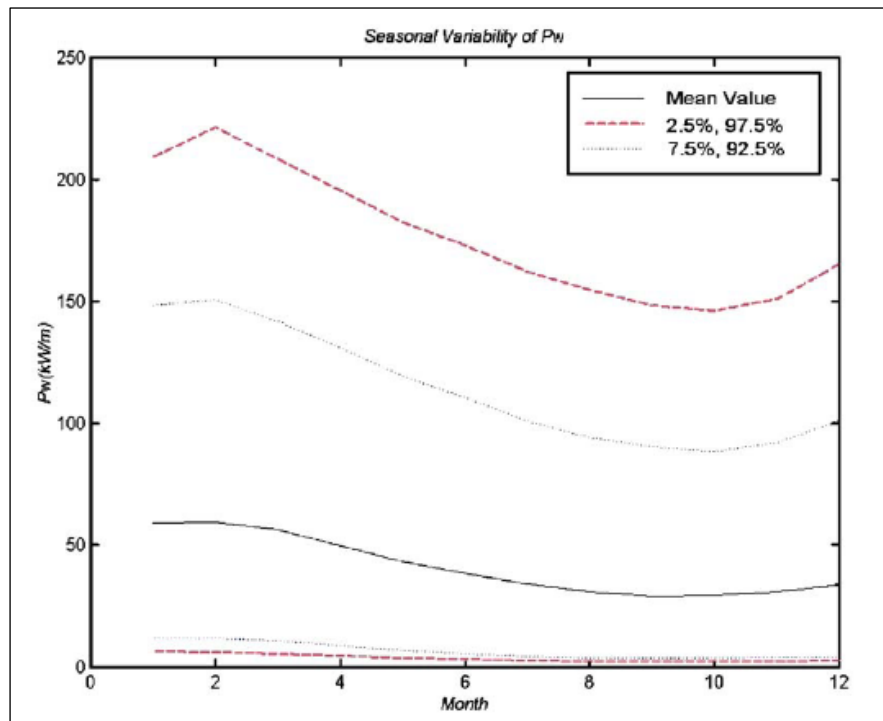

Figure 1.53. Seasonal variation of wave energy profile for Northern California.

From Beyene and Wilson (2006).

Large scale interannual oscillations such as El Niño/La Niña Southern Oscillations and the Pacific Decadal Oscillation (PDO) have been found to correlate with wave climate along the Northern Study Area (Allen and Komar 2000; Allen and Komar 2006). During El Niños the storm systems follow a more southerly track, bringing anomalously high wave conditions to the California coast. It was expected that a southerly storm track would reduce wave heights off the coast of the northern regions of the Northern Study Area. But findings by Allen and Komar (2006) suggest that even though the wave climate is weaker along the coast of the northern regions than along the California coast during positive MEI, it does not appear the wave climate is weakened along the northern regions due to a southerly shift in the storm track. Also, during the 1997-98 El Niño the entire West Coast, including the northern regions of the Northern Study Area, experienced unusually high waves (Allen and Komar 2000). The results in [Figure 1.54](#) indicate that both the MEI and the North Pacific Index (NPI) represent significant climate controls on the West Coast wave climate, with the NPI being more important to annual wave conditions off the northern regions of the Northern Study Area, whereas both NPI and MEI are important in California (Allen and Komar 2006) (the MEI and NPI are described in further detail in [Section 1.5, Interannual Fluctuations](#)). Wave heights increased during the 1982-83 and 1997-98 winters, which represent the strongest El Niños, and wave heights decreased during the 1988-89 La Niña winter, which represents the strongest La Niña.

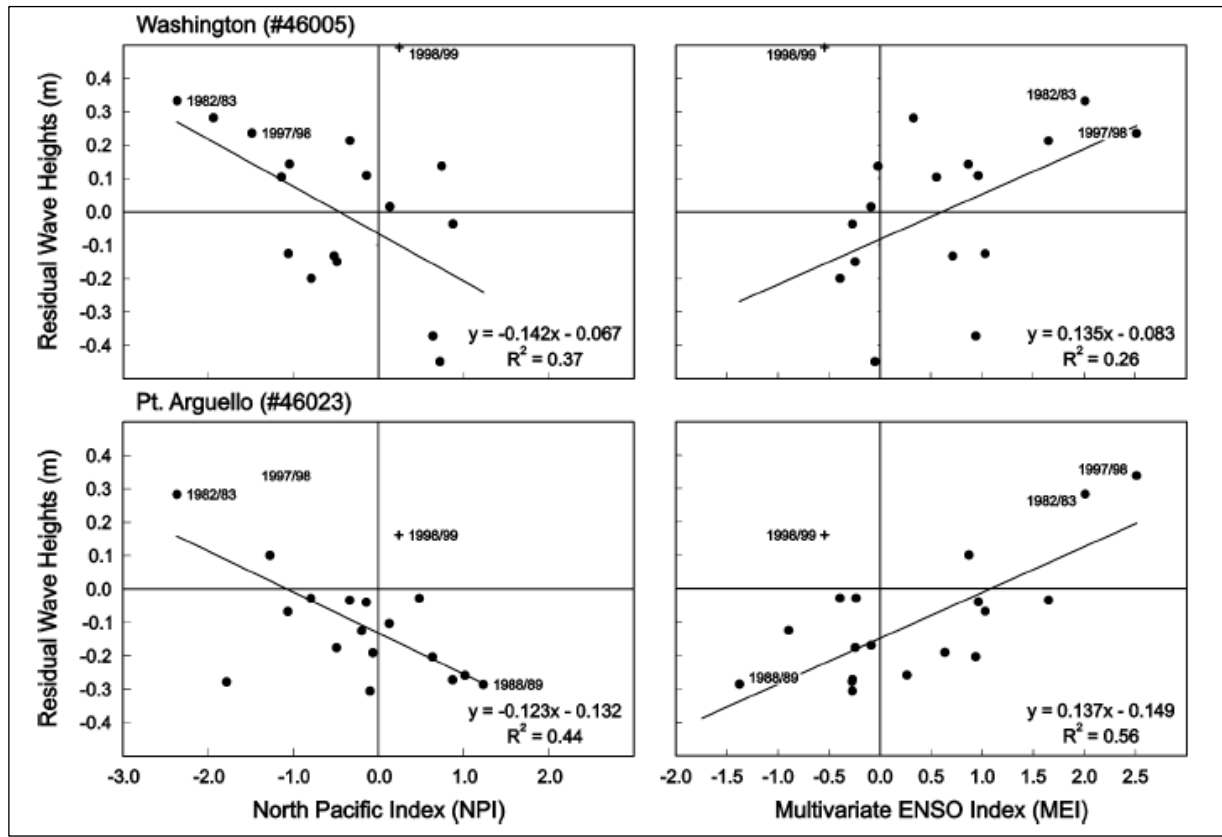

Figure 1.54. The Annual wave height residuals for the Washington and Pt. Arguello (Southern California) buoys vs. the NPI and MEI measured indices.

From Allen and Komar (2006).

In addition to the effect of El Niño and La Niña oscillations on wave heights, there has been a significant increase in storm-generated wave heights over the last three decades along the Northern Study Area (Allen and Komar 2000; Allen and Komar 2006) (Figure 1.55). Before 1997 it was projected that the 100-year deepwater significant wave height off the coast of Oregon was about 10 m (Tillotson and Komar 1997). Since then, 10-meter wave heights were exceeded by one storm during the 1997-98 El Niño and four storms during the 1998-99 La Niña (Allen and Komar 2000). One storm in March 1999 had significant wave heights that exceeded 14 m. This supports the belief that not only mean significant wave heights, but also maximum wave heights, are increasing.

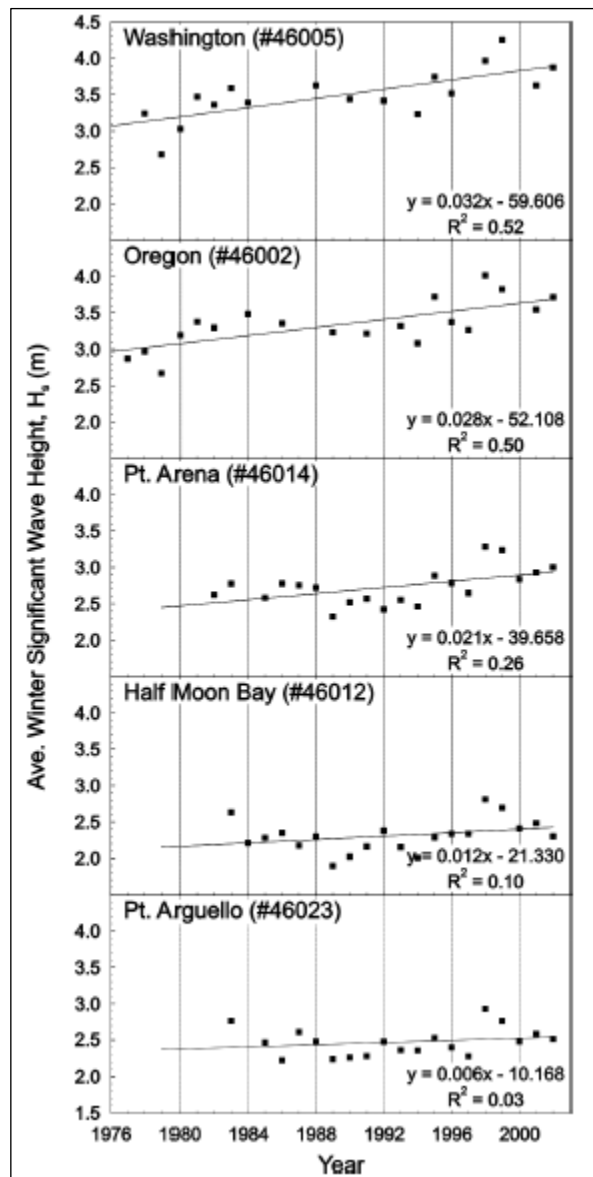

Figure 1.55. Decadal trends in annual averages of the winter significant wave heights measured by West Coast buoys at different latitudes.

From Allen and Komar (2006).

1.6.3 Connection With Littoral Processes and Sediment Transport

Along most of the Northern Study Area, wave dynamics are the primary mechanism that adjusts the shoreline. Breaking waves provide the most important energy input in nearshore waters and are responsible for the generation of nearshore currents, high levels of turbulence, and the transport of sediments. These processes control the morphology of beaches, sand barriers, and spits at the mouths of estuaries (Largier 2008).

Waves have a large impact on the shape and profile of beaches. The beach profile is important, since it works as a natural mechanism that causes waves to break and dissipate their energy. Increased wave energy causes the beach to respond by reducing its overall slope and shifting the breaker zone farther offshore. The ability of a beach to adjust to the prevailing forces makes it an effective method of coastal defense (Largier 2008). The effect of waves on beaches can be put into two simplified cases: destructive effect during storm events and constructive effect during calm events (Dean and Dalrymple 2002). Storm-driven destructive forces erode the beach and develop an offshore sand bar, whereas constructive forces act to move the sand bar closer to shore and steepen the beach profile. The gradually sloping beach with an offshore sand bar is often referred to as the “winter profile,” and the wide beach with a steep profile on the shoreline is often referred to as the “summer profile.” The variance in wave heights throughout the year typically causes a long-term balance in the amount of sediment supplied to and taken from a beach. If wave heights were reduced, as they would be by offshore WEC devices, the beach could experience net accretion and increased beach steepness (Largier 2008).

Wave properties change as waves interact with shallow waters near the shore. As the propagation speeds of waves decrease over shallow water and become a function of water depth, their periods remains the same, their wavelengths decrease, and their heights and steepness increase (Largier 2008). This process is called “shoaling.” In addition, waves traveling over varying degrees of shallowness refract toward shallower water. This leads to waves focusing on headlands and bars and to waves dissipating in deep embayments and channels. The height of nearshore waves is a function of the deepwater wave height, the degree of refraction, and the degree of shoaling (Dean and Dalrymple 2002). As a wave approaches the shore, its steepness generally increases up to the point where it becomes unstable and breaks. Theoretical studies of waves in constant-depth water showed that a wave breaks when its height exceeds approximately 80 percent of the water depth. When a wave breaks, the amount of energy released depends on the wave’s initial characteristics and the shape of the shoreline. If the shore angle is steep, the wave will reflect. This leads to offshore sand bar development and the creation of cusps.

There are four distinct hydrodynamic forces due to breaking waves acting on objects in the surf zone (Largier 2008): (1) drag, (2) lift, (3) acceleration, and 4) impingement. These four hydrodynamic forces are calculated using the velocity in the surf zone (details and formulas can be found in (Largier 2008)). Velocity in the surf zone varies as the square root of maximum wave height. From this relationship, a 15 percent reduction in wave height results in a 7.8 percent reduction in velocity. The hydrodynamic forces (drag, lift, acceleration, and impingement) are linearly dependent on wave height, so a 7.8 percent reduction in water velocity would correspond to a 15 percent reduction in each of the four hydrodynamic forces.

Three important characteristics of nearshore impacts of wave energy are turbulence, wave “runup,” and wave “setup.” Waves create turbulence, a property of water motion that involves chaotic water movement on multiple scales, resulting in small-scale, nonlinear flow. Turbulence is increased by the presence of obstacles in the flow, by roughness of the surface over which water is flowing, and by water velocity. Turbulent flow is particularly important for the transport of small particles, including nutrients and sediment. Wave “runup,” R , is the maximum vertical extent of wave uprush on a beach or shoreline. The runup height is dependent on wave

energy, beach slope, beach roughness and water level modulations due to tides, winds and runoff to the ocean. Wave “setup” is the buildup of water along the shore due to wave-driven currents (Largier 2008).

Nearshore currents are primarily due to wave radiation stresses and alongshore differences in wave setup (Largier 2008). Waves drive alongshore currents and rip currents, which transport water offshore. Undertow and rip currents are important for the transport of larval organisms away from the shore during the early stages of development. Wave-driven alongshore currents are generated by a combination of obliquely breaking waves and longshore variations in wave setup. Longshore currents are related to breaker height and incident angle.

The earth’s changing climate has been a primary factor affecting erosion along the Northern Study Area. Over the last 25 years there has been an increase in wave-controlled nearshore processes due to an increased number of intense North Pacific wave-generating storms (Allen and Komar 2006). In addition to the gradual increase in wave activity over the last 25 years, there are also climatic variations that affect erosion. Variations in deepwater winter wave heights and swash runup levels have been found to depend on the NPI and MEI climate indices (Allen and Komar 2006). The strong El Niños of 1982-83 and 1997-98 account for the most severe instances of erosion along the West Coast. Since the storm track during El Niños is displaced southward, there is a tendency for waves to approach the coast from the south, producing a northward transport of sand. This sand displacement has been shown to result in erosion north of headlands and jetties. Although the last 25 years have seen a strong El Niño regime that has exhibited increased storm-related impacts at lower latitudes, Allen and Komar (2006) suggest that recent evidence indicates a transition to a La Niña regime. The transition, in which the storm track is shifted northward, would cause a reduction in erosion.

1.6.4 Available Energy

Most of the wave energy received by west-facing coastlines around the world is due to midlatitude, eastward-propagating storms, which direct their energy eastward. The North Pacific is one of the most energetic regions in the world and the northwest coast of the United States is well oriented to receive this energy. For comparison purposes, a worldwide map of wave power is provided in [Figure 1.56](#).

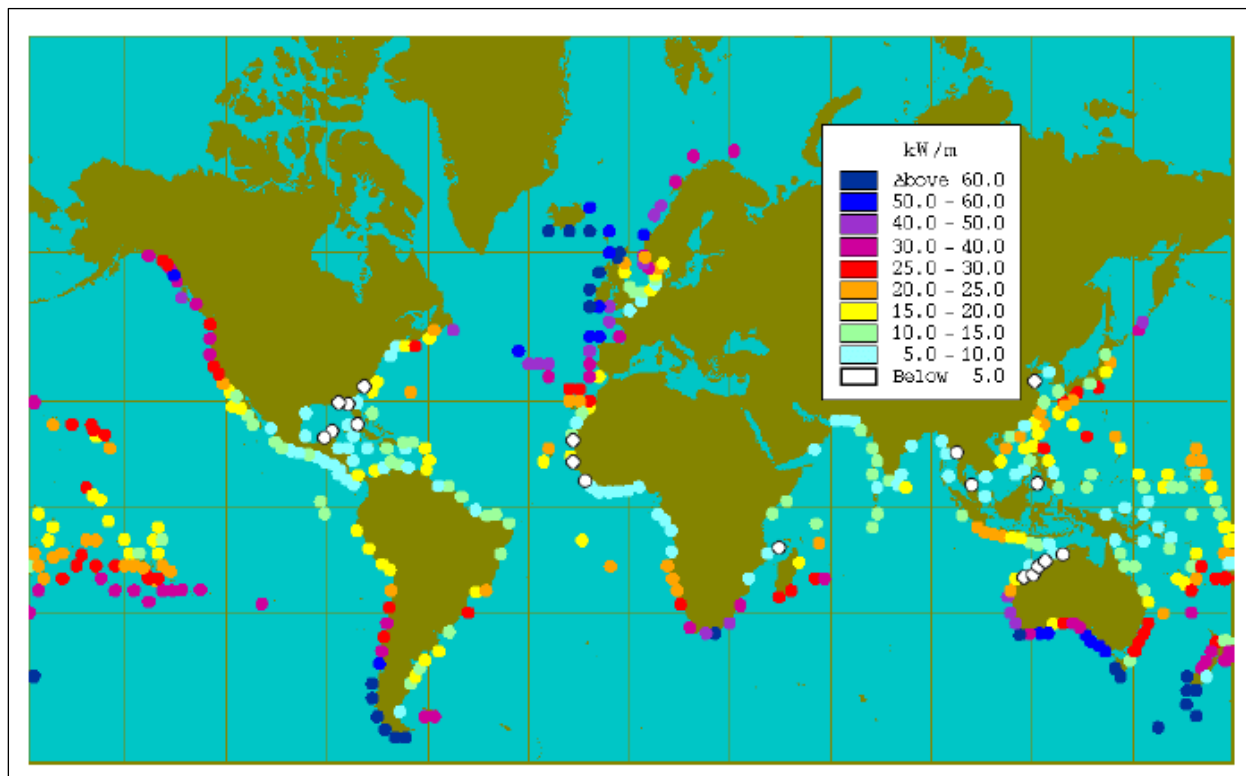

Figure 1.56. Annual wave power averages worldwide in kW/m wave front.

From E.P.R.I. (2005).

The theoretical potential wave power available along the California coast is estimated at 38 gigawatts according to the California Energy Commission (Behrens et al. 2008). California uses an average of about 32 gigawatts. Since the Oregon and Washington coasts typically receive more wave power per meter than does the California coast, and taking into account their coastlines are shorter than California's, the theoretical potential wave power available along the Northern Study Area is approximately three times that of California alone, for a total of 114 gigawatts.

The power of ocean waves is often expressed in kilowatts per meter wave crest (kW/m). The available power along the Northern Study Area ranges from an average of 30 kW/m to a maximum of about 1,000 kW/m during a winter storm. Along the Northern California coast wave power studies have reported available wave power densities ranging from 30 to 34 kW/m (E.P.R.I. 2005; Beyene and Wilson 2006). Based on findings that show increasing mean significant and maximum wave heights along the northern regions of the Northern Study Area (Figure 1.47), it can be inferred that more wave power is available off the northern regions of the northern study than off the southern regions. This energy can be roughly estimated by taking the difference in significant wave heights between California on the one hand and Washington and Oregon on the other to calculate wave power density E or wave power flux F using significant wave height. Table 1.1 shows NDBC measurements of the average wave power flux for various locations along the California coast from Point Conception to the Oregon border.

Table 1.1.

Average wave power flux (wave power) from NDBC buoy measurements at California locations north of Point Conception.

Note that these buoys are offshore, typically in depths of greater than 100m and out of wave shadow zones found nearer to the shore (e.g., northern Gulf of Farallones). Table modified from PIER (2007).

NDBC buoy	Latitude	Location	Wave Energy Flux (kW/m)
46011	34.88	Santa Maria	26
46028	35.74	Cape San Martin	30
46042	36.75	Monterey	30
46013	38.23	Bodega Bay	30
46014	39.22	Point Arena	32
46030	40.42	Blunts Reef	29
46022	40.72	Eel River	34
46027	41.85	St. Georges	27

Source: Largier et. al.

From Behrens et al.(2008)

In the Electric Power Research Solutions report on the Oregon wave energy resource (E.P.R.I. 2005) the annual wave energy scatter diagram ([Table 1.2](#)) was developed by extracting the significant wave height, H_s , and the peak wave period, T_p , from the sea state parameter records at the Coquille River CDIP buoy, buoy 0037. [Figure 1.57](#) shows the graphical relations between lines of constant wave power density, P , and gradient or slope, H/L , as functions of the significant wave height, H_s , and zero crossing period, T_p (E.P.R.I. 2005). A statistical wave distribution is also superimposed on the figure.

Table 1.2.

Coquille River reference scatter diagram.

CDIP '0037 Coquille River		Upper Tp:	3.5	4.5	5.5	6.5	7.5	8.5	9.5	10.5	11.5	12.5	13.5	14.5	15.5	16.5	17.5	18.5	20.5	8766	
		Lower Tp:	2.5	3.5	4.5	5.5	6.5	7.5	8.5	9.5	10.5	11.5	12.5	13.5	14.5	15.5	16.5	17.5	18.5	19.5	Total annual hours
Hs and Tp bin boundaries		Tp (sec)																			
Lower Hs	Upper Hs	Hs (m)	3	4	5	6	7	8	9	10	11	12	13	14	15	16	17	18	18	20	
9.75	10.25	10	0	0	0	0	0	0	0	0	0	0	0	0	0	0	0	0	0	0	0
9.25	9.75	9.5	0	0	0	0	0	0	0	0	0	0	0	0	0	0	0	0	0	0	0
8.75	9.25	9	0	0	0	0	0	0	0	0	0	0	0	0	0	0	0	0	0	0	0
8.25	8.75	8.5	0	0	0	0	0	0	0	0	0	0	0	0	0	0	0	0	0	0	0
7.75	8.25	8	0	0	0	0	0	0	0	0	0	0	0	0	0	0	0	0	0	0	0
7.25	7.75	7.5	0	0	0	0	0	0	0	0	0	0	0	0	0	0	0	0	0	0	0
6.75	7.25	7	0	0	0	0	0	0	0	0	0	0	0	0	0	0	0	0	0	0	1
6.25	6.75	6.5	0	0	0	0	0	0	0	0	0	0	1	1	2	1	0	0	0	0	5
5.75	6.25	6	0	0	0	0	0	0	0	0	1	2	3	2	1	3	1	0	0	0	13
5.25	5.75	5.5	0	0	0	0	0	0	0	0	3	6	5	1	0	1	0	0	0	0	18
4.75	5.25	5	0	0	0	0	0	0	1	2	4	8	18	10	5	4	1	0	0	0	53
4.25	4.75	4.5	0	0	0	0	0	0	3	5	10	25	32	18	4	5	0	1	0	0	101
3.75	4.25	4	0	0	0	0	1	1	9	14	21	41	64	25	12	8	5	5	1	0	207
3.25	3.75	3.5	0	0	0	1	1	7	17	21	49	69	98	31	19	12	9	5	0	0	339
2.75	3.25	3	0	0	0	2	8	16	51	69	110	152	128	52	22	15	6	5	1	0	638
2.25	2.75	2.5	0	0	0	13	25	57	153	142	174	207	158	51	35	25	12	5	2	0	1,057
1.75	2.25	2	0	0	5	44	108	184	329	256	274	254	181	57	36	31	23	11	4	0	1,796
1.25	1.75	1.5	0	1	24	143	290	379	471	357	220	197	144	55	37	27	17	9	2	0	2,372
0.75	1.25	1	0	9	55	148	304	335	317	312	115	87	81	45	31	29	12	6	0	0	1,884
0.25	0.75	0.5	0	1	7	21	35	34	25	65	18	11	21	18	12	7	3	0	0	0	274
0	0.25	0.125	0	0	0	0	0	1	5	0	0	0	0	0	0	0	0	0	0	0	7
		8,766	1	10	91	369	772	1,014	1,383	1,241	996	1,057	934	367	216	166	92	48	9		8,766

From (E.P.R.I. 2005)

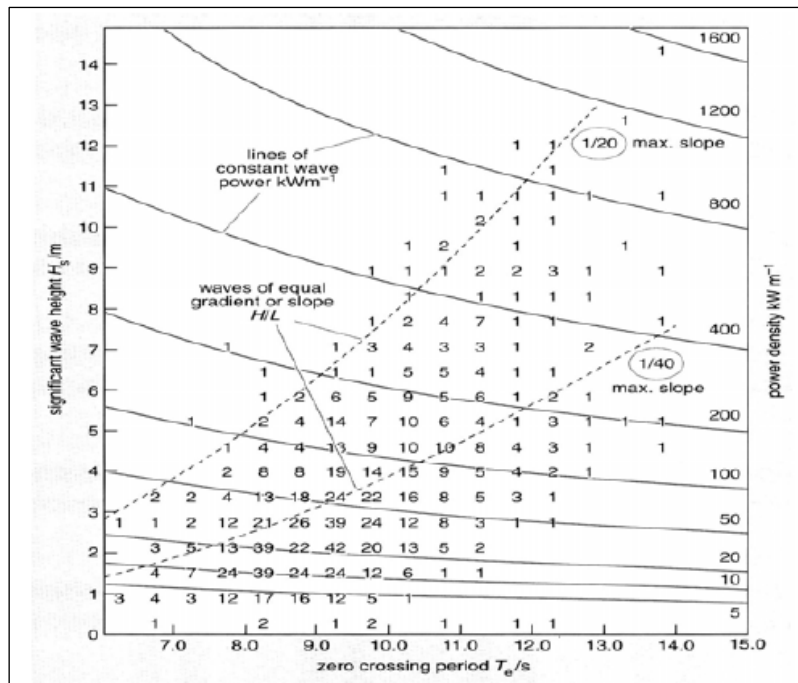

Figure 1.57. Statistical wave distribution matrix and lines of constant wave power and gradient.

From E.P.R.I. (2005).

1.7 SUMMARY AND DATA GAPS

There is certainly a significant wind and wave energy resource along the northwest coast of the United States. The amount of wind and wave energy that can be utilized will depend on technological, environmental, economic, social, and legal limitations (Largier 2008). The sections above on the physical oceanography environment along the northwest coast are intended as a literature review and synthesis that can be used as a reference.

There is a definite seasonal variation in the winds, currents, and water properties along the northwest coast. The small number of NDBC buoys off the coasts of Washington and Oregon limits our ability to model and analyze the physical environment in the region.

The seasonal wind environment along the northwest coast is separated around mid-Oregon. Upwelling-favorable (southward) winds along the California and southern Oregon coast driven by the North Pacific High dominate in the spring/summer months. During the fall and winter the influence of the North Pacific High is weakened by cyclonic low pressure systems (storms) and intermittent high pressure development inland. This causes the mean wind flow to weaken and occasionally become downwelling-favorable (northward). Northern Oregon and Washington winds are typically weakly southward during the spring and summer and downwelling-favorable during the fall and winter, when the Aleutian Low strengthens to drive the flow northward.

The ocean currents along the northwest coast are often strongly correlated with the winds, but not always. A sea surface pressure gradient force typically sets up to oppose wind-driven currents – an equatorward pressure gradient occurs along the Washington coast and a poleward pressure gradient occurs off California. The California and Oregon coast typically follows an upwelling/relaxations seasonal pattern: during the spring and summer, strong persistent upwelling-favorable winds drive the surface flow equatorward and the fall/winter relaxation of upwelling-favorable winds allows the sea surface pressure gradient to drive the surface flow poleward. Off Washington the opposite occurs: downwelling-favorable winds drive the surface flow poleward during the fall and winter and the relaxation of these downwelling-favorable winds in the spring and summer allows the sea surface pressure gradient to drive the flow southward. Natural interannual climatic variations cause a spatial and temporal variability to the onset and termination of the upwelling/relaxation seasonal cycle.

Upwelling, typically during the spring and summer along the California and Oregon coast, is caused by strong, persistent southward winds along the West Coast. The mechanisms responsible for upwelling are offshore Ekman transport, wind stress curl, and surface divergence.

Subtidal currents show peaks in power spectral density plots at diurnal, inertial, and seasonal frequencies as well as very low frequency (VLF). The diurnal peak is due to diurnal wind stress, the inertial peak is due to earth's rotation, the VLF peak is due to oceanic mesoscale forcing, and the seasonal peak is due to the seasonal variations in wind stress and sea surface pressure gradient force. There are three dominant currents that make up the California Current System: The California Current, which flows southward outside of the continental shelf, the Davidson Current, which is a seasonal current that flows poleward over the continental shelf during the fall

and winter, and the California Undercurrent, which is a subsurface current that flows poleward along the continental slope.

The Columbia River plume tends to behave as a poleward buoyancy flow when there is no external forcing. But variations in the wind field have a strong effect on the plume. Southward wind stress tends to drive the plume offshore and northward wind stress tends to cause it to meander poleward and along the coastline. The southward and offshore transport of the plume has an effect on the biomass offshore of Oregon, and the northward transport of the plume has an effect on the biomass off the Washington coast. Low salinity tidal pulses from the Strait of Juan de Fuca and the San Francisco Bay also demonstrate buoyancy flow characteristics.

Tidal currents make up between two percent and eight percent of the total current variance along the northwest coast. The two dominant tidal constituents are the M_2 principal lunar semidiurnal and K_1 luni-solar diurnal. The M_2 barotropic tide acts as a coastally trapped Kelvin-like wave affected by variations in the coastal boundary as it propagates poleward. Diurnal (K_1) barotropic currents propagate poleward as a combination of Kelvin and continental shelf waves trapped along the coast. Tidal variances around the San Francisco Bay were found to be above 50 percent and similar patterns are believed to occur near the Columbia River mouth and offshore of the Strait of Juan de Fuca.

There are three primary water sources that impact the north study area: North Pacific Subarctic water (PSW), North Pacific Central water (PCW), and the North Pacific Equatorial or Subequatorial water (PEW). PSW is characterized by low salinity and temperature and high oxygen and nutrients, PCW is characterized by high salinity and temperature and low oxygen and nutrients, and PEW is characterized by high salinity, temperature and nutrients and low oxygen.

There are four general categorizations of wave sources: North Pacific swell, South Pacific swell, northwest wind swell, and local wind waves. The North Pacific swell is generated by powerful storm systems in the North Pacific; it approaches the West Coast from a west-northwest direction. These swells usually have large amplitudes and long periods; they create the largest breaking waves when they reach the coast. South Pacific swells are generated by powerful storms in the South Pacific, approach the coast from the southwest, and have long periods but smaller amplitudes than the North Pacific swell, due to attenuation. The northwest wind swell is generated by winds from the north typically associated with the North Pacific High pressure system. These swells are associated with large amplitudes and short periods. Local wind waves are generated by local winds, can approach the coast from any angle, and typically have small amplitudes and short periods.

Wave energy along the northwest coast is seasonally dependent. Most wave energy occurs during the late winter due to a combination of storm-driven North Pacific swell and early spring northwest wind swell. The smallest amount of wave energy occurs in late summer and early fall.

There is strong evidence that wave heights associated with North Pacific winter storms are increasing. Correlations between wave heights and climate indices such as the Multivariate ENSO Index (MEI) and North Pacific Index (NPI) have been found.

Wave dynamics are the primary mechanism for altering the shoreline. Breaking waves near the coastline generate longshore and cross-shore currents and turbulence, which act together to transport particles such as nutrients and sediment. As a general rule, a decrease in wave energy causes a net accretion along the shore, but this may not always be the case. Decreased wave energy also acts to reduce the offshore sand bar, and this could allow more wave energy to reach the shoreline and thus increase erosion.

A rough estimate of all wave energy reaching the northwest coast is about 114 gigawatts. This is enough energy to power California, Oregon, and Washington, although realistically, only a very small portion of this energy is attainable. Along the Northern California coast wave power densities average between 30 and 35 kW/m. Oregon and Washington typically experience higher mean wave heights ([Figures 1.47](#) and [1.55](#)) and should therefore have higher wave power densities.

There is an information gap pertaining to whether deployment of WEC devices will impact the storage and resuspension of sediments and nutrients on the shelf. The work by Bruland et al. (2001) indicates the importance of mobilization of iron in the shelf sediments for the upwelling plumes.

For both wind energy and wave energy, future research will be geared toward answering the following questions: What is the energy potential? How can the energy potential be realized? What are the environmental effects of the reduction of energy in the ocean by energy-capturing devices?

Regarding information gaps, one advantage wind power has over wave power is that there are already offshore wind parks established in Europe. Some of the European offshore wind parks have been in place long enough to illuminate possible effects of offshore wind energy capture that were previously unknown. The coastal wind environment off Europe is fairly similar to that of the northwest coast of the United States. Like the northwest coast of the United States; the coast of Europe is at midlatitudes, west-facing, and on the eastern boundary of a large ocean.

Although wind parks have been established in Europe for some time, there does not appear to be very much research on the oceanographic effects of offshore wind energy removal by wind parks. However, research has been performed on the effects of wind energy removal and wind-turbine-induced turbulence in regard to wind park efficiency and energy production. From the results of these studies the effects on the ocean can be inferred, but they are not specific. Data gaps exist on the effects of wind energy removal on upwelling. For these gaps to be filled, the effects on the mechanics of upwelling may need to be addressed: How might surface divergence, wind stress curl, and Ekman transport be affected? Other questions that should be answered are: How might decreased wind speed and increased turbulence in the wake of

turbines affect ocean surface mixing? How might ocean atmosphere fluxes be affected? How much of the sea surface behind wind turbines might be affected?

There is a data gap on the longshore and cross-shore variability of the winds (in magnitude and direction). Future research in this area would be useful in maximizing offshore wind park efficiency. Previous research has shown that there is considerable longshore and cross-shore variability in the winds and that the wind environment is very site-specific (i.e. the offshore wind environment is not uniform). Significant differences in the winds recorded at buoys along the coast indicate variations in the wind environment. The sparsely placed buoys collecting meteorological data along the coast are not able to completely resolve all nuances in the wind environment. Unless proposed wind parks are immediately adjacent to buoys where long-term wind data sets are available, there will be site-specific data gaps. Increasing the density of buoys would improve forecast ability and provide more continuous data.

According to the California Energy Commission (PIER 2007), there is a theoretical potential of 38 gigawatts, with an estimated technical potential of about 7 to 8 gigawatts. The technical potential is about one-fourth of California's energy needs. The extent to which wave energy conversion (WEC) devices will be able to harness the technical potential of ocean waves along the coast will depend on technological, environmental, economic, social, and legal limitations. A cross-shore understanding of directional properties of wave energy propagation as waves are refracted near the coast will be important for WEC device placement. As deep ocean waves and their energy approach the coast and traverse over shallow waters, they are refracted. Waves from the north and south will typically be refracted so that they arrive perpendicular to the coast.

If wave heights were reduced, as they would be by offshore WEC devices, the beach could experience net accretion and increased beach steepness (Largier 2008).

The lack of research in the fields of sediment transport and its relation to varying wave environments makes it difficult to assess the impacts of seasonal and longer-term changes in the wave environment. In addition, the impacts of reducing wave energy in the nearshore zone due to absorption of energy by WEC devices are difficult to assess (Largier 2008). In the case of decreases in wave energy due to WEC devices, beaches may adjust to accommodate the lower wave energy by more frequently forming the typical summer shape, which consists of a single concave decline in elevation and a small offshore sand bar (Largier 2008). Longshore sediment transfer would likely decrease due to the decrease in wave energy; this decrease would in turn cause buildup of beaches and increase beach slope. The reduced sediment transport could also decrease the tendency of coastal inlets to move laterally and close. This would result from an increased ability of inlet channel currents driven by waves and river flow to scour the smaller supply of sediment that arrives at the mouth of the inlet.

There is an information gap regarding the effects of WEC parks on the shoreline even if the expected impacts are believed to be small. At this time there are no large-scale WEC parks in existence, so actual data are not available. Beach morphology and sediment transport along the northwest coast are already an area that is sparsely studied. Different studies on different beaches have produced different results, so there is no unified theory regarding beach

morphology and sediment transport. Derivations used to describe the dynamics at some beaches do not apply to others. It appears that the nearshore effects of waves are very site-specific. Generalizations about how decreased wave energy will affect the shoreline should therefore not be made. Research will need to be performed on specific regions directly inshore of proposed WEC parks. For each proposed site, research will be needed on how decreases in wave height affect the incident angle of breaking waves as well as the distance from shore at which waves break, and how such decreases affect offshore sand bars, sediment transport, nearshore currents, wave runup, and estuary mouth morphology. Implementation of wave models will also be useful. Although there have been studies on how waves are diffracted by objects that block them, no studies have investigated how diffracted wave energy will be affected by partially blocked waves. Wave models could determine the extent of the “wave shadow” and how diffracted waves will eventually constructively interfere with each other.

There is a data gap in directional wave energy spectrum research which is needed to maximize energy capture efficiency. Most research on directional wave spectrum analysis has been geared toward beach erosion and sediment transport. Little research has been done on directional wave energy spectra, even though many CDIP buoys have been collecting data along the West Coast for over 10 years. The data are there. It would not be difficult to perform a directional wave energy spectral analysis.

1.8 LIST OF LITERATURE CITED—PHYSICAL OCEANOGRAPHY

- Allen, J.C. and P.D. Komar. 2000. Spatial and temporal variations in the wave climate of the North Pacific. Report to the Oregon Dept. of Land Conservation and Development, Salem, Oregon.
- Allen, J.C. and P.D. Komar. 2006. Climate controls on the U.S. West Coast erosion process. *Journal of Coastal Research* 22(3):511-529.
- Austin, J.A. and J.A. Barth. 2002. Drifter behavior on the Oregon–Washington Shelf during downwelling-Favorable winds. *Journal of Physical Oceanography* 32(11):3132-3144.
- Banas, N.S., P. MacCready, and B.M. Hickey. 2008. The Columbia River plume as cross-shelf exporter and along-coast barrier. *Continental Shelf Research*, doi:10.1016/j.csr.2008.03.011
- Bane, J.M., M.D. Levine, R.M. Samelson, S.M. Haines, M.F. Meaux, N. Perlin, P.M. Kosro and T. Boyd. 2005. Atmospheric forcing of the Oregon coastal ocean during the 2001 upwelling season. *J. Geophys. Res* 110. C10S02, doi:10.1029/2004JC002653.
- Barth, J.A. 2003. Anomalous southward advection during 2002 in the Northern California Current: Evidence from Lagrangian surface drifters. *Geophys. Res. Lett* 30(15):8024.
- Barth, J.A. and R. L Smith. 1997. “Coastal Ocean Circulation off Oregon: Recent Observations of Spatial and Temporal Variability” p 57-68. In Emmett, R. L., M. H. Schiewe. (eds.) *Estuarine and ocean survival of Northeastern Pacific salmon: Proceedings of the workshop March 20-22, 1996 in Newport Oregon*. U.S. Dept. of Commerce, NOAA Tech. Memo., NMFS-NWFSC-29. 313 pp.

- Barth, J.A., B.A. Menge, J. Lubchenco, F. Chan, J.M. Bane, A.R. Kirincich, M.A. Mcmanus, K.J. Nielsen, S.D. Pierce and L. Washburn. 2007. Delayed upwelling alters nearshore coastal ocean ecosystems in the Northern California Current. *Proceedings of the National Academy of Sciences* 104(10):3719.
- Barth, J.A., S.D. Pierce and T.J. Cowles. 2005. Mesoscale structure and its seasonal evolution in the Northern California Current System. *Deep-Sea Research Part II* 52(1-2):5-28.
- Barth, J.A., S.D. Pierce and R.L. Smith. 2000. A separating coastal upwelling jet at Cape Blanco, Oregon and its connection to the California Current System. *Deep-Sea Research Part II* 47(5-6):783-810.
- Batchelder, H.P., J.A. Barth, P.M. Kosro, P.T. Strub, R.D. Brodeur, W.T. Peterson, C.T. Tynan, M.D. Ohman, L.W. Botsford and T.M. Powell. 2002. The GLOBEC northeast Pacific California Current System program. *Oceanography* 15(2):36–47.
- Beardsley, R., C. Dorman, C. Friehe, L. Rosenfeld and C. Winant. 1987. Local atmospheric forcing during the Coastal Ocean dynamics experiment 1. In: *A Description of the Marine Boundary Layer and Atmospheric Conditions over a Northern California Upwelling Region*. *J. Geophys. Res.* 92(C2):1467-1488.
- Bedard, R., G. Hagerman, M. Previsic, O. Siddiqui, R. Thresher and B. Ram. 2005. Final summary report: Project definition study—Offshore wave power feasibility demonstration project. E21 EPRI Global WP.
- Behrens, D., J. Castle, G. Crawford, R.N. Gaddam, S.C. Hackett, J. Largier, D.P. Lohse, K.L. Mills, P.A. Nelson, P.T. Raimondi, M. Robart, W.J. Sydeman, S. Thompson and S. Woo. 2008. Developing wave energy in Coastal California: Potential socio-economic and environmental effects. Prepared for: California Energy Commission.
- Beyene, A. and J.H. Wilson. 2006. Comparison of wave energy flux for northern, central, and southern coast of California based on long-term statistical wave data. *Energy* (31):1856-1869.
- Bruland, K.W., E.L. Rue, G. J. Smith. 2001. Iron and macronutrients in California coastal upwelling regimes: Implications for diatom blooms. *Limnology and Oceanography*. 46 (7):1661-1675.
- Collins, C.A., L.M. Ivanov, O.V. Melnichenko, and N. Garfield. 2004. California undercurrent variability and eddy transport estimated from RAFOS float observations. *J. Geophys. Res.* 109.
- Dean, R.G. and R.A. Dalrymple. 2002. Coastal processes with engineering applications. Cambridge Press, Cambridge.
- Dever, E.P. 1997. Wind-forced cross-shelf circulation on the Northern California Shelf. *Journal of Physical Oceanography* 27(8):1566-1580.

- Di Lorenzo, E., N. Schneider, K.M. Cobb, P.J.S. Franks, K. Chhak, A. J. Miller, J. C. McWilliams, S.J. Bograd, H. Arango, E. Curchitser, T. M. Powell and P. Riviere. 2008. North Pacific Gyre oscillation links ocean climate and ecosystem change. *Geophysical Research Letters* 35(L08607):1-6.
- Dorman, C.E., T. Holt, D.P. Rogers, and K. Edwards. 2000. Large-scale structure of the June-July 1996 marine boundary layer along California and Oregon. *Monthly Weather Review* 128(June 2000):1632-1652.
- Dorman, C. and C. Winant. 1995. Buoy observations of the atmosphere along the West Coast of the United States, 1981-1990. *J. Geophys. Res.* 100(C8):16029-16044.
- E.P.R.I. 2005. Oregon offshore wave demonstration project: Bridging the gap between the completed Phase 1 project definition study and the next phase-Phase 2 detailed design and permission.
- Erofeeva, S.Y., G.D. Egbert and P.M. Kosro. 2003. Tidal currents on the central Oregon shelf: Models, data, and assimilation. *J. Geophys. Res.* 108:3148.
- Flament, P. 1985. Finestructure and subduction associated with upwelling filaments. University of California, San Diego. 142 pp.
- Gan, J. and J.S. Allen. 2002. A modeling study of shelf circulation off Northern California in the region of the Coastal Ocean Dynamics Experiment 2. Simulations and Comparisons with Observations. *Journal of Geophysical Research* 107(C11): 3123, doi:10.1029/2000JC000768.
- Garfield, N., C.A. Collins, R.G. Paquette and E. Carter. 1999. Lagrangian exploration of the California Undercurrent, 1992–1995. *Journal of Physical Oceanography* 29:560–583.
- Garfield, N., M.E. Maltrud, C.A. Collins, T.A. Rago and R.G. Paquette. 2001. Lagrangian flow in the California undercurrent: An observation and model comparison. *Journal of Marine Systems* 29(1-4):201-220.
- Gough, M. 2008. An analysis of HF-radar measured surface currents, Gulf of the Farallones, California. San Francisco State University Master's of Science Thesis (Applied Geosciences).
- Hapke, C.J., D. Reid, B.M. Richmond, P. Ruggiero and J. List. 2006. National assessment of shoreline change. Part 3: Historical shoreline change and associated land loss along sandy shorelines along the California Coast. USGS Open File Report 2006-1219.
- Hickey, B.M. 1998. Coastal oceanography of western North America from the tip of Baja California to Vancouver Island. In: A.R. Robinson and K.H. Brink. *The Sea*, Volume 11. John Wiley and Sons, Inc. Pp. 345-393.
- Hickey, B.M., R.M. Kudela, J.D. Nash, K.W. Bruland, W.T. Peterson, P. MacCready, E.J. Lessard, D.A. Jay, N.S. Banas, A.M. Baptista, E.P. Dever, P.M. Kosro, L.K. Kilcher, A.R.

- Horner-Devine, E.D. Zaron, R.M. McCabe, J.O. Peterson, P.M. Orton, J. Pan and M.C. Lohan. 2010. *Journal of Geophysical Research* 115, C00B17, doi:10.1029/2009JC005452.
- Hickey, B., A. Macfadyen, W. Cochlan, R. Kudela, K. Bruland and C. Trick. 2006. Evolution of chemical, biological, and physical water properties in the Northern California Current in 2005: Remote or local wind forcing? *Geophys. Res. Lett.* 33(22):1-5.
- Hickey, B.M., L.J. Pietrafesa, D.A. Jay and W.C. Boicourt. 1998. The Columbia River plume study: Subtidal variability in the velocity and salinity fields. *Journal of Geophysical Research* 103(C5):10339-10368.
- Hickey, B. and N. Pola. 1983. The seasonal alongshore pressure gradient on the West Coast of the United States. *J. Geophys. Res.* 88(C12):7623-7633.
- Huyer, A. 1976. A comparison of upwelling events in two locations: Oregon and Northwest Africa. *J Mar Res* 34:531– 546.
- Huyer, A. 1983. Coastal upwelling in the California Current System. *Progress in Oceanography* 12(3):259-284.
- Huyer, A., J.H. Fleischbein, J. Keister, P.M. Kosro, N. Perlin, R.L. Smith and P.A. Wheeler. 2005. Two coastal upwelling domains in the Northern California Current System. *Journal of Marine Research* 63(5):901.
- Huyer, A., P.M. Kosro, J. Fleischbein, S.R. Ramp, T. Stanton, L. Washburn, F.P. Chavez, T.J. Cowles, S.D. Pierce and R.L. Smith. 1991. Currents and water masses of the coastal transition zone off Northern California, June to August 1988. *Journal of Geophysical Research* 96(C8): 14,809–14,831.
- Janssen, T.T., H.C. Herbers and J.A. Battjes. 2006. Generalized evolution equations for nonlinear surface gravity waves over two-dimensional topography. *Journal of Fluid Mechanics* 552:393-418.
- Kaplan, D.M. and J. Largier. 2006. HF radar-derived origin and destination of surface waters off Bodega Bay, California. *Deep-Sea Research Part II-Topical Studies in Oceanography* 53(25-26):2906-2930.
- Kaplan, D.M., J. Largier and L.W. Botsford. 2005. HF radar observations of surface circulation off Bodega Bay (Northern California, USA). *Journal of Geophysical Research* 110 C10020, doi: 10.1029/2005JC002959.
- Knauss, J.H. 2005. *Introduction to physical oceanography*. Long Grove, IL: Waveland Press, Inc. P. 309.
- Kosro, P.M. 2002. A poleward jet and an equatorward undercurrent observed off Oregon and Northern California, during the 1997–98 El Niño. *Progress in Oceanography* 54(1-4):343-360.

- Largier, J. 2008. The potential impact of WEC development on nearshore and shoreline environments through a reduction in nearshore wave energy. In: *Developing Wave Energy in coastal California: Potential socio-economic and environmental effects*. California Energy Commission, PIER Energy-Related Environmental Research Program and California Ocean Protection Council.
- Largier, J.L., C.A. Lawrence, M. Roughan, D.M. Kaplan, E.P. Dever, C.E. Dorman, R.M. Kudela, S.M. Bollens, F.P. Wilkerson, R.C. Dugdale, L.W. Botsford, N. Garfieldg, B.K. Cervantes and D. Koracin. 2006. WEST: A Northern California study of the role of wind-driven transport in the productivity of coastal plankton communities. *Deep-Sea Research Part II Topical Studies in Oceanography* 53(25-26):2833-2849.
- Largier, J., B. Magnell and C. Winant. 1993. Subtidal circulation over the Northern California Shelf. *J. Geophys. Res.* 98(C10):18147-18179.
- Luther, D.S. and Carl Wunsch. 1975. Tidal charts of the Central Pacific Ocean. *Journal of Physical Oceanography* 5:222-230.
- Lynn, R.J. and J.J. Simpson. 1987. The California Current System: The seasonal variability of its physical characteristics. *Journal of Geophysical Research* 92(c12):12947–12966.
- MacFadyen, A., B.M. Hickey and W. P. Cochlan. 2008. Influences of the Juan de Fuca Eddy on circulation, nutrients, and phytoplankton production in the Northern California Current System. *J. Geophys. Res.* 113(C8):1-19.
- MacFadyen, A., B.M. Hickey and M.G.G. Foreman. 2005. Transport of surface waters from the Juan de Fuca eddy region to the Washington coast. *Continental Shelf Research* 25(16):2008-2021.
- Mantua, N.J. and S.R. Hare. 2002. The Pacific decadal oscillation. *Journal of Oceanography* 58(1):35-44.
- McGowan, J., S.J. Bograd, R.J. Lynn and A. Miller. 2003. The biological response to the 1977 regime shift in the California Current. *Deep-Sea Research* 50:2567-2582.
- Meyers, S.D., A. Melsom, G.T. Mitchum and J.J. O'Brien. 1998. Detection of the fast Kelvin wave teleconnection due to El Niño southern oscillation. *Journal of Geophysical Research-Oceans* 103(C12):27655-27663.
- Noble, M.A. and S.R. Ramp. 2000. Subtidal currents over the central California slope: Evidence for offshore veering of the undercurrent and for direct, wind-driven slope currents. *Deep Sea Research Part II: Topical Studies in Oceanography* 47(5-6):871-906.
- Noble, M., L.K. Rosenfeld, R.L. Smith, J.V. Gardner and R.C. Beardsley. 1987. Tidal currents seaward of the Northern California Continental Shelf. *Journal of Geophysical Research* 92(C2):1733-1744.

- Peterson, B., R. Emmett, R. Goericke, E. Venrick, A. Mantyla, S.J. Bograd, F.B. Schwing, S. Ralston, K.A. Forney, R. Hewitt, N. Lo, W. Watson, J. Barlow, M. Lowry, B.E. Lavanigos, F. Chavez, W.J. Sydeman, D. Hyrenbach, R.W. Bradley, P. Warzybok, K. Hunter, S. Benson, M. Weise and J. Harvey. 2006. The state of the California current, 2005-2006: Warm in the North, cool in the South. California Cooperative Oceanic Fisheries Investigations Reports 47:30-74.
- PIER. 2007. Summary of PIER-Funded Wave Energy Research. California Energy Commission. PIER Program. CEC-500-2007-083. 122 pp.
- Pierce, S.D., R.L. Smith, P.M. Kosro, J.A. Barth and C.D. Wilson. 2000. Continuity of the poleward undercurrent along the eastern boundary of the midlatitude North Pacific. Deep-Sea Research Part II 47(5-6):811-829.
- Ramp, S.R., J.L. McClean, C. A. Collins, A.J. Semtner and K.A.S. Hays. 1997. Observations and modeling of the 1991-1992 El Niño signal off central California. Journal of Geophysical Research-Oceans 102(C3):5553-5582.
- Redmond, K.T. and R.W. Koch. 1991. Surface climate and streamflow variability in the western United States and their relationship to large-scale circulation indexes. Water Resources Research 27(9):2381-2399.
- Rosenfeld, L.K. 1988. Diurnal period wind stress and cCurrent fluctuations over the continental shelf off Northern California. Journal of Geophysical Research-Oceans 93(C3):2257-2276.
- Roughan, M., N. Garfield, J. Largier, E. Dever, C. Dorman, D. Peterson, and J. Dorman. 2006. Transport and retention in an upwelling region: The role of across-shelf structure. Deep-Sea Research Part II 53(25-26):2931-2955.
- Samelson, R, P. Barbour, J. Barth, S. Bielli, T. Boyd, D. Chelton, P. Kosro, M. Levine, E. Skyllingstad and J. Wilczak. 2002. Wind stress forcing of the Oregon coastal ocean during the 1999 upwelling season. J. Geophys. Res. 107:3034.
- Schwing, F.B., S.J. Bograd, C.A. Collins, G. Gaxiola-Castro, J. Garcia, R. Goericke, J. Gomez-Valdez, A. Huyer, K.D. Hyrenbach and P.M. Kosro. 2002. The state of the California Current, 2001-2002: Will the California Current System keep its cool, or is El Niño looming? CalCOFI Rep 43.
- Scott, D. 2005. Pacific Ocean wave information study validation of wave model results against satellite altimeter data. Draft Report, W.F. Baird and Associates, September 25, 2005.
- Shinker, J.J. and P.J. Bartlein. 2009. Visualizing the large-scale patterns of ENSO-related climate anomalies in North America. Earth Interactions 13:50.
- Steger, J.M., F.B. Schwing, C.A. Collins, L.K. Rosenfeld, N. Garfield and E. Gezgin. 2000. The circulation and water masses in the Gulf of the Farallones. Deep-Sea Research Part II 47(5-6):907-946.

- Strub, P.T., J.S. Allen, A. Huyer, R.L. Smith and R. Beardsley. 1987. Seasonal cycles of currents, temperatures, winds, and sea level over the northeast Pacific continental shelf. *J. Geophys. Res.* 92(C2):1507-1526.
- Tillotson, K. and P.D. Komar. 1997. The wave climate of the Pacific Northwest (Oregon and Washington): A comparison of data sources. *Journal of Coastal Research* Vol. 13 (No. 2 (spring)):440-452.
- Tolman, H. L. 2009. <http://polar.ncep.noaa.gov/mmab/papers/tn276/MMAB_276.pdf> : User manual and system documentation of WAVEWATCH III version 3.14. NOAA / NWS / NCEP / MMAB Technical Note 276, 194 pp.+ Appendices.
- Winant, C., R. Beardsley and R. Davis. 1987. Moored wind, temperature, and current observations made during Coastal Ocean dynamics experiments 1 and 2 over the Northern California Continental Shelf and Upper Slope. *J. Geophys. Res.* 92(C2):1569-1604.
- Wing, S.R. L.W. Botsford, S.V. Ralston and J. L. Largier. 1998. Meroplanktonic distribution and circulation in a coastal retention zone of the Northern California upwelling system. *Limnology and Oceanography* 43(7): 1710-1721.
- Wiseman, W.J. and R.W. Garvine. 1995. Plumes and coastal currents near large river mouths. *Estuaries and Coasts* 18(3):509-517.
- Wyrtki, K. 1975. El Niño-The dynamic response of the equatorial Pacific Ocean to atmospheric forcing. *Journal of Physical Oceanography* 5(October):572-584.

2. GEOLOGICAL OCEANOGRAPHY

The Northern Study Area extends from offshore of the Golden Gate near San Francisco to Grays Harbor. It encompasses the offshore areas of three states, the northern part of California, all of Oregon and the southern portion of Washington. This area includes all three types of global tectonic plate boundaries: 1) transform or strike-slip, 2) convergence or subduction, and 3) divergence or spreading. The Mendocino Triple Junction (MTJ) junction exists just below the state boundary between California and Oregon, making the region more complex. This triple junction is a transform, transform, trench (subduction) triple junction.

Unlike the Southern Study Area, the northern part of the Northern Study Area consists of generally narrow continental shelf and slope with deep (abyssal depth) basins fringed on the west by volcanically active ridges. The region is best described as an active volcanic arc setting that includes several types of transform fault zones (e.g., oceanic-oceanic and oceanic-continent). South of the triple junction, the continental shelf is primarily controlled by an oceanic-continent separating transform fault, which primarily exists in the offshore there.

2.1 DESCRIPTION AND PHYSIOGRAPHY

The physiography of the Northern Study Area reflects the tectonic processes that have been active for the past 40 million years or so. Tectonic elements that form the physiography of the region resulted from the collision and fragmentation of the Farallon Plate as it was subducted beneath the North American Plate (Orr and Orr 1996). Today remnants of the Farallon Plate are exhibited as the Gorda and Juan de Fuca Plates, which are separated by the Blanco Fracture Zone (a transform fault) ([Figure 2.1](#)). The spreading centers that produce new volcanic seafloor and separate the Gorda Plate and Juan de Fuca plates from the Pacific Plate are the Gorda and Juan de Fuca Ridge (Orr and Orr 1996). The relative oblique convergence between the Gorda and Juan de Fuca plates with the North American Plate is 4 cm/yr, while right-lateral strike-slip between the Gorda and Juan de Fuca Plates along the Gorda Fracture Zone is 5.6 cm/yr (CPC 1985) ([Figure 2.1](#)). Convergence (collision of the Gorda and Juan de Fuca Plates with the North American Plate) is expressed as a subtle trench at the base of the slope and called the Cascadia Subduction Zone, which is generally filled with sediments. The down-going plates along the Cascadia Subduction Zone scrape off materials that accrete to the overlying plate and form an accretionary wedge whose front is locally exposed along the continental slope (Orr and Orr 1996).

Separating the Cascadia subduction complex to the north from the transform fault margin to the south is the Mendocino Fracture Zone (a transform fault). In the southern part of the Northern Study Area physiography is primarily controlled by the tectonic activity of the San Andreas Fault Zone, a major transform right-lateral strike-slip fault that separates the Pacific Plate from the North American Plate. Here the fault is moving at a relative rate of 5.6 cm/yr while the absolute rate of motion of the Pacific Plate is 8 cm/yr (CPC 1985).

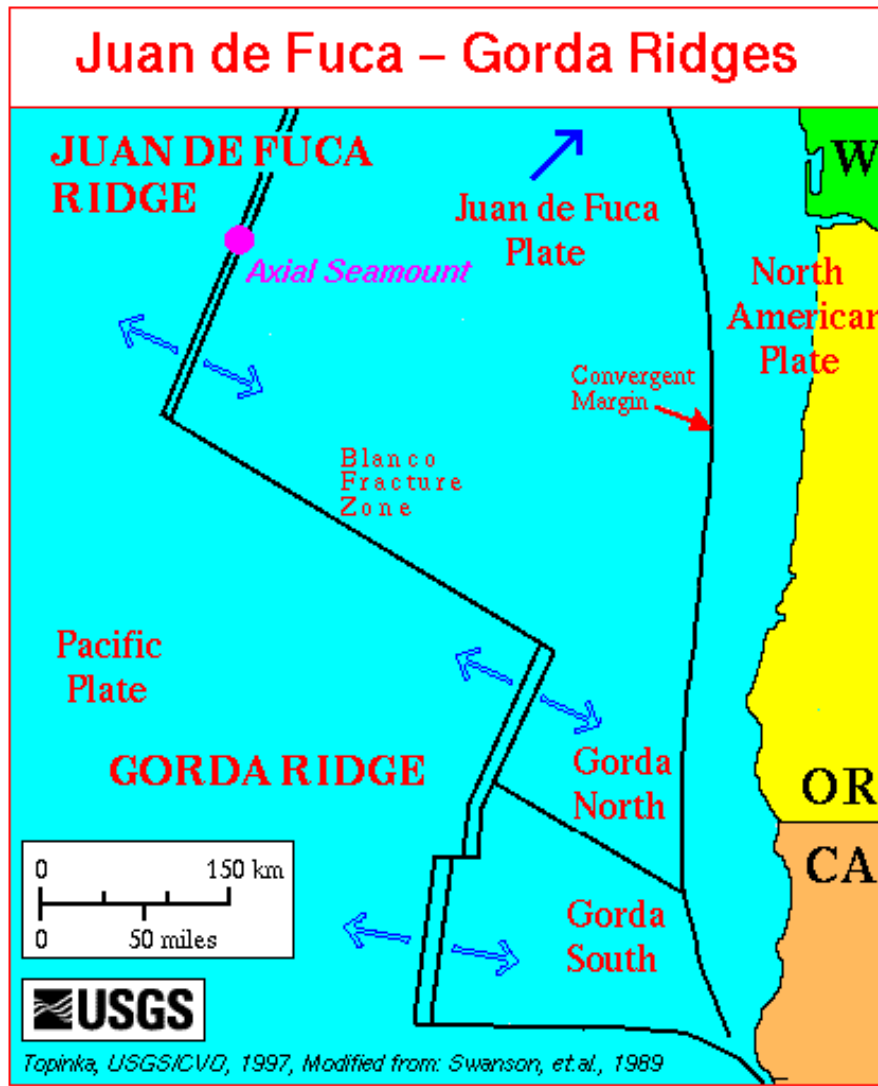

Figure 2.1. Juan de Fuca Ridge - Gorda Ridge - Axial Seamount -- showing features of Pacific/Juan de Fuca/North American subduction system relative to Western United States.

Open blue arrows, ridge-spreading directions; solid blue arrow, convergence direction.

(Source
http://vulcan.wr.usgs.gov/Glossary/PlateTectonics/Maps/map_juan_de_fuca_ridge.html.
 Modified from: Swanson, et.al., 1989, IGC Field Trip T106: Cenozoic Volcanism in the Cascade Range and Columbia Plateau, Southern Washington and Northernmost Oregon, p.2.

Onshore and near the coastline of Cape Mendocino is the MTJ that represents the connection and motion transfer of the three active plate boundaries in the region. These tectonic elements, or boundaries, are the Cascadia Subduction Zone, the Mendocino Fracture Zone (a transform fault) and the San Andreas Fault (another transform fault). Thus, the triple junction is a trench (subduction), transform (fault), transform (fault) triple junction. This triple junction is migrating

to the north as the Gorda and Juan de Fuca plates subduct, an action that eventually will extend the San Andreas Fault to the north and reduce volcanism (Orr and Orr 1996).

2.1.1 Continental Shelf and Slope

Major offshore physiographic features of Washington and Oregon include the continental shelf, continental slope and Cascadia Basin. The continental shelf of Oregon is a relatively flat, gently sloping surface that varies in width from 17 km off Cape Blanco to 74 km off the central coast (Snively 1987). The continental slope of Oregon is narrow, varying in width from 20 km at Cape Blanco to 96 km off the Columbia River. Low benches and hills characterize the upper slope; most notably, pop-up fault blocks cause ponding of sediment on the Cascade Bench off the north coast of Oregon. The lower slope intersects the deep sea floor of the Cascadia Basin at 2200 m depth off the north coast, and at about 3,000 m off the central and south coast (Parmenter and Bailey 1985).

The continental shelf of Northern California slopes more gradually and is narrower (generally less than 50 km wide) than in Southern California (Jones and Stokes 1981). However, the slope is offset further offshore than in Central California, similar to the offset slope of Southern California (Clarke 1987). Pop-up fault blocks of sedimentary rock, related to underthrusting of the accretionary wedge at the base of the continental slope along northernmost California, cause ponding of sediment and form the Klamath Bench, which continues into the Southern Oregon continental slope.

2.1.2 Submarine Canyons and Sea Valleys

The Rogue, Astoria, Quinault, Willapa, Guide, and Grays Submarine Canyons cut the continental shelf of Oregon and Washington. The Astoria Canyon cuts into the continental shelf about 17 km west of the Columbia River; the Astoria Fan lies at the base. In contrast the much smaller Rogue Canyon, which cuts into the shelf edge offshore of the Rogue River, feeds directly down the continental slope and into the Cascadia Basin (The Oregon Ocean Book 1985). Of the five million tons of sediment discharged annually from the Columbia River, approximately five percent is deposited in the Astoria Canyon, three percent in the Quinault Canyon, two percent in the Willapa Canyon, and 1 percent in the Grays Canyon (Wolf et al. 1999).

Submarine canyons that cut the narrow continental shelf offshore of Northern California include the Eel Submarine Canyon, which begins at the inner shelf, about 10 km offshore of the Eel River, north of the Gorda Escarpment (Mullenbach and Nittrouer 2000); and the Trinidad Canyon, which cuts the continental shelf north of the Eel Canyon. Two submarine canyons, the Mendocino and Mattole, are associated with the Gorda Escarpment. The Delgado Canyon, near Point Delgado is particularly important in that it initiates within the inner shelf, only about 2 kilometers offshore, and transports considerable sediment to the Delgado Deep Sea Fan (Jones and Stokes 1981). The upper part of the Eel Canyon is the most studied canyon of all the canyons in the Northern Study Area. Considerable sediment reaches the upper part of the Eel submarine canyon following winter flooding, although sediment appears to accumulate in the upper canyon year-round. Gravity-driven processes may be an important mechanism for transport of these sediments to lower parts of the canyon, triggered perhaps by seismic events (Mullenbach and Nittrouer 2000).

2.1.3 Seamounts

No seamounts occur on the continental shelf in the Northern Study Area. In the northern part of the Northern Study Area, within and adjacent to the Cascadia Margin, several major seamounts exist and consist of (from south to north) President Jackson, Vance, Cobb, Eickelberg, and Union seamounts (Orr and Orr 1996). Dellwood and Tuzo Wilson knolls also exist just north of the study area, offshore of Victoria Island. Several unnamed seamounts are present in Cascadia Basin, in an area that has not been completely covered by sediment.

In the southern part of the Northern Study Area, in the San Andreas Fault area, several unnamed seamounts exist along the mid- to lower-slope and on the abyssal plain (Goldfinger et al. 2008). Many of these seamounts have their bases covered with sediment and appear very much like the seamounts located on the slope of central California (Pioneer, Guide and Gumdrop seamounts; Greene et al. 2002).

2.1.4 Ridges and Banks

A series of large ridges of the subduction-related accretionary zone at the base of the continental slope offshore of Oregon and Washington resulted from movement along north-south trending thrust faults, with ridge crests elevated 400 m to 1000 m above the abyssal plain of the Cascadia Basin (Kulm et al. 1986).

The continental shelf offshore of Oregon has several rocky submarine banks. Four major banks create shallow water environments within the deeper water of the shelf: Nehalem Bank, Stonewall Bank, Heceta Bank, and Coquille Bank. These banks are tectonic features, related to accretionary underthrusting and underplating at the base of the continental slope. Erosional remnants of these compressionally uplifted features commonly form rocky outcrops on the inner shelf, especially between the Rogue River and Coos Bay.

One large ridge and a major uplifted block occur in the deep water offshore of Northern California and Southern Oregon. Both are related to large-scale compressional tectonics associated with sea floor spreading and subduction. The Gorda Ridge is a narrow shelf parallel to an elongate ridge in the deep Cascadia Basin, and is the surface expression of the tectonic spreading center that runs from the MTJ to the Blanco Fracture zone to the north. The Gorda Escarpment, a north-facing scarp bordering the Mendocino transform fault, occurs at about 40° N. This broad feature appears to be a relatively recently elevated tectonic block of the Pacific plate, uplifted by north-south compression across the transform fault (Godfrey et al. 1998).

The Gorda and Juan de Fuca ridges are major tectonic features that are volcanically active (spreading centers) that produce new oceanic (basaltic) seafloor as they push the Gorda and Juan de Fuca plates beneath the North American Plate (Orr and Orr 1996). These ridges are major plate boundaries and separate the Pacific Plate from the Gorda and Juan de Fuca plates.

2.1.5 Basins of the Continental Shelf and Slope

There are no continental borderland-like basins along the coast of Oregon or Washington.

In Northern California, the Eel River Basin, located on the continental shelf and stretching from the MTJ north into the waters offshore of Oregon, has a high sedimentation rate, fed by the Eel, Mad, and Klamath Rivers. Glacioeustatic fluctuations appear to be the primary control on basin-wide nonconformities, but northward migration of the adjacent MTJ has caused rotation of preexisting structures, uplift of the Table Bluff Anticline (TBA) (which extends from onshore to offshore), subsequent periods of channel incision south of the TBA, and reduced preservation of sediment on the shelf (Burger et al. 2002). The basin has a depth of less than 120 m; topographic mounds (20 km x 6 m) are the product of sediment accumulation from the Mad and Eel Rivers in a dynamically stressed regime (Goff et al. 1996). The basin floor is generally smooth except for small-scale bioturbation and shore-normal low relief striations (possibly caused by sea floor current erosion) that are up to 1 km wide (Goff et al. 1996). A sequence stratigraphic analysis of seismic data indicates that preserved sediment in the shelfal basin is dominated by fluvially derived silts and muds that are deposited during high stands of sea level, and that are distributed by longshore waves and currents (Burger et al. 2002).

2.1.6 Deltas and Submarine Fans

No major deltas are present on the continental shelves of the Northern Study Area. Two well-developed submarine fans are present offshore of Washington: the Astoria Fan and the Willapa Fan. The Astoria Canyon lies offshore of the mouth of the Columbia River, which feeds sediment to the canyon head and elsewhere to the shelf and slope. In addition, sediment is fed to the canyon head by seasonal southern flowing currents.

Although rivers such as the Klamath possess gently sloping deltas, most of the rivers in Oregon and Washington have drowned mouths and estuaries. If sea floor conditions and sediment type is right even small deltas can be subject to mass movement. The delta of the Klamath River underwent slope failure following a November 1980 earthquake; leaving a sinuous scarp, one-meter high and 20 km long, although the delta slope is only 0.25 degrees (Field et al. 1982). However, recent studies offshore of this area indicate that features previously identified as mass movement are most likely dynamic bedforms such as sediment wave fields (Lee et al. 2004).

The extremely large (350-km in length) Tufts Submarine Fan occurs in the deep basin off Northern California, west of the Gorda Ridge, but is linked to turbidite and gravity sediment flows from the Washington Continental Shelf, via the Cascadia Channel to the north, and through the Blanco Fracture Zone. Sediments in the southern part of the Tufts Fan Reach the Escanaba Trough, along the southern axis of the Gorda Ridge, just north of the Mendocino Fracture Zone. Sediments in the upper 120 m of the Escanaba Trough, have a Columbia River provenance and are coincident with timing of the Missoula floods created by the failure of a natural dam of Lake Missoula in Pleistocene time (Reid and Normark 2003).

Part of the Missoula flood sediments reached the deep basin Tufts Fan offshore of California through a tortuous path that included the Astoria and Willapa Submarine Canyons and Fans. The sediments were transported by turbidity currents and gravity flows between the thrust faulted

accretionary ridges on the continental slope, and down the Cascadia Channel to water depths of around 2,500 to 3,500 m (Pratson and Haxby 1996). Turbidites associated with earthquakes are represented by more sand-rich sediment in canyons, whereas fine sediment dominates normal deposition between earthquakes (Goldfinger et al. 2000).

2.2 DISTRIBUTION AND FATE OF CHEMICAL CONSTITUENTS IN SEDIMENTS

Chemical constituents are introduced to the marine environment by both natural and anthropogenic means. Natural erosion onshore and erosion of exposed bedrock on the shelf separate and concentrate minerals, which are transported to regions of deposition, where they may concentrate further. Anthropogenic compounds are introduced to the marine environment through industrial and urban waste disposal on land. Waste products are often caught up in wastewater runoff on land where they are transported by fluvial processes and delivered to the marine environment.

Along the continental shelf of northern Oregon, measurements of water column turbidity indicate that suspended sediment concentrates at the seasonal thermocline, at the permanent pycnocline, and at the sea floor. Turbidity of the bottom zone varies with current strength and the amount of material at the water-sediment interface, whereas turbidity of the midwater layer appears to be most strongly related to distance from a sediment source. The midwater layer thickness increases with distance from shore (Harlett and Kulm 1973).

The distribution and fate of chemical constituents in continental shelf sediments include mineralization and dissolution of particulate organic matter. Shum and Sundby (1995) conclude that the passage of gravity waves and bottom currents over irregular surfaces of the continental shelf can enhance organic mineral crystallization in sandy shelf substrates.

The majority of the hydrocarbon compounds, PAH, perlene, and retene, enter the continental shelf water via the Columbia River, and accumulate on the shelf where deposition is active (Prahl et al. 1984).

2.2.1 Sedimentary Organic Matter

Primary production in the ocean is strongly seasonal, with the Columbia River supplying about 6×10^5 tons of organic carbon per year, about 89 percent as dissolved organic carbon and the rest as particulate fossil organic compounds. Organic matter deposited on the continental slope may be higher due to summer deposition, but is less well documented (de Haas et al. 2002).

Unconsolidated sediments on the California continental shelf that are located away from river mouths and other fluvial inputs are largely relict; most of the terrestrially sourced sediments are captured in submerged stream channels, structural depressions and, in Southern California, in continental borderland basins (de Haas et al. 2002). Twenty-five percent of the sedimentary organic matter comes from river input; the rest is from primary production in the marine environment.

2.2.2 Composition of Sedimentary Organic Matter

About 75 percent of the sedimentary organic matter on the Washington and Oregon Shelf comes from primary production, and about 25 percent is from dissolved organic carbon from rivers and from particulate fossil carbon (de Haas et al. 2002).

Local rivers supply 80 percent of the total sediment input to Northern California's continental slopes and submarine fans, including some terrigenous organic matter. Marine primary production supplies the remaining carbonate, silica, and 75 percent of the organic matter.

2.2.3 Trace Metals

In general, marine sediments high in clays tend to retain heavy metals and phosphorus. Iron concentrations in surface waters along the Oregon shelf are higher in spring than in summer and are higher north of 44.5° N. In contrast, concentrations in shelfal bottom water are higher in the summer. Iron particles travel downslope, and sink through the water column in the inner and midshelf areas, apparently associated with aggregates of clay and with phytoplankton. This remineralized iron may accumulate within the benthic boundary layer (Chase et al. 2005).

2.2.4 Early Diagenetic Processes

Early diagenetic processes include mineralization and dissolution of particulate organic matter on the continental shelf and are enhanced by the passage of gravity waves and bottom currents over irregular sandy surfaces (Shum and Sundby 1995). Other early diagenetic processes include deposition of carbonate related to methane seeps on accretionary ridge-related fault blocks of the continental slope off Oregon and Washington. Relict sediments in areas of low sediment accumulation rates may undergo replacement by phosphate minerals.

2.3 GEOLOGIC HAZARDS

Geohazards in the Northern Study Area are primarily generated by tectonic processes including earthquakes and their consequences. Earthquakes in the Northern Study Area are generated from two major tectonic processes: 1) strike-slip and oblique convergent motion along the northern San Andreas Fault System and 2) thrust movement along the subduction zones of the Juan de Fuca and Gorda plates. Von Huene et al. (2009) discuss the most recent kinematic and dynamic models of convergent plate margins. In the Northern Study Area, the Cascadia Region Earthquake Workgroup (2005) has developed a Cascadia Subduction Zone magnitude 9.0 Scenario. Shaking from earthquakes, severe storms and tsunamis can excite and destabilize seafloor sediments producing liquefaction and mass wasting on gentle slopes, and delta fronts and rockfalls, slumps and turbidity currents (gravity flows) in submarine canyons and steep slopes. For example, Goldfinger et al. (2003a, 2003b) present evidence from the turbidite record that 13 earthquakes have ruptured the Cascadia margin from Vancouver Island to at least the California border. The 13 events have an average repeat time of 600 years since the first post-Mazama event 7500 years ago, with the most recent event 300 years ago. They suggest that only earthquakes appear to have led to turbidite formation along the northernmost San Andreas margin during the last 2000 years. The BOEMRE Project Offshore Deep Slopes (PODS): Seafloor Stability on the Continental Shelf/Slope (C-CORE 2002), though focused on the Gulf of Mexico, does contain world-wide information on submarine slides in offshore areas worldwide, including the Eureka

(Humboldt) Retrogressive Slump (southern part of Eel River Basin). If an earthquake is of a large magnitude (M7.0 or greater), seafloor disruption (extensive vertical offset) or rapid large displacements of landslides through mass movement could produce a locally-derived tsunami (Whitmore 2003; Whitmore et al. 2008).

In addition to rapid fault motion, slow creep-like motion and compression along faults can deform and warp the seafloor producing irregular and hummocky topography. Although less consequential, scouring from currents, storms and turbidity currents along the seafloor and in canyon axes are a hazard that can cause destabilization of slope sediment and undermining of canyon walls. Fluid expulsion and the formation of rills and gullies also can produce a hazard to the stabilization of seafloor structures.

2.3.1 Scouring Action of Bottom Currents Including Turbidity Currents

Over the last 30 years the Oregon and Washington Coasts have been subjected to an increasingly energetic wave climate, increases in coastal erosion, and increases in human impacts related to use of the Columbia River. Although sediment accumulation rates on the shelf as measured in 2005 are identical to the 1975-76 rates within a 95 percent confidence level, the surficial sediment was eight to nine percent coarser in 2005 than in 1975 and 1976 (Davies and Nittrouer 2006). The greatest increase in wave climate is offshore of Washington, where average heights of winter storm-generated waves have increased by 0.88 m since 1976, with the largest storm waves having increased by 2.0 m in height. Wave height increases are slightly less in Oregon and Northern California. The East Pacific Pattern, the Southern Oscillation, and the effects of La Niña and El Niño events all appear to contribute to this phenomenon (Allan and Komar 2000).

Scouring action is predominant within submarine canyons, especially in those canyons that head near river mouths. Major rivers that empty into the Northern Study area from Point Reyes north include the Russian, Gualala, Navarro, Big, Noyo, Ten Mile, Mattole, Eel, and Mad Rivers in Northern California; Klamath, Smith, Chetco, Pistol, Rogue, Sixes, Coquille, Coos, Umqua, Siuslaw, Yaquina, Salmon, Nestucca, Nehalem, and Columbia in Oregon; Columbia, Palix, and Chehalis. All of these and smaller rivers and creeks supply sediment to the continental shelf that can scour the seafloor and supply sediment to submarine canyon heads. Turbidity currents are often concentrated in the canyons and feed the turbidite fans (Nitinat and Astoria fans) located in Cascadia Basin (Goldfinger et al. 2008). Much of the sediment that is derived from these rivers feed directly into submarine canyon heads or is swept to the heads by littoral drift. From Point Reyes north to Cape Mendocino these canyons are Cordell, Bodega, Albion, Gualala, Arena, Noyo, Vicaino, and Gorda (Goldfinger et al. 2007).

Recurrence intervals of turbidity current events are generally related to earthquakes and dating of cored turbidites in submarine canyons and channels (Goldfinger et al. 2008) have shown that an average repeat time of ~200 years occurs for the southern part of the Northern Study Area (northern San Andreas Fault region) and a similar rate for the southern Cascadia subduction margin with a repeat time of ~220 years. For the full Cascadia margin Goldfinger et al. (2008) come up with a recurrence interval of ~520 years.

2.3.2 Mass Wasting – Slope and Canyon Wall Failures

Slope failure appears to account for greater mass wasting in the Northern Study Area than does canyon wall failure. Mass wasting deposits along the continental slope offshore of Northern California include the Humboldt Slide just west of the Eel River Basin ([Figure 2.2](#)). This feature appears to have originated about 450 thousand years (ka) ago in response to uplift caused by the northward migration of the MTJ (Burger et al. 2003) and may represent multiple events (Goff et al. 1996). The slump does not have a sharp headward scarp, but instead appears to merge gently with the slope. Geomorphic features of the slump include lump blocks, pressure ridges, and gullies that transport sediment down the slump scarp and deposit it. Movement of the slump appears to continue by sediment creep along internal glide planes (Burger et al. 2003).

Surprisingly, the greatest potential for large slope failure events does not appear to be offshore of the Columbia River. Two distinct morphologic clusters of submarine landslides occur along the Oregon Continental Slope. North of 44.84°, 11 of the 13 slides present are small and fragmented, and are generally associated with smooth slopes. South of that latitude, seven of the nine slides present are large and cohesive, and occur on a rough, irregular slope (MacAdoo and Watts 2004). These morphologic differences reflect the occurrence of underlying structures: Most of the northern landslides occur on the flanks of anticlines expressed on the sea floor; the southern landslides appear to follow seaward verging structures. Two of the southern landslides are located on the upper continental slope, three occur at the base of the slope and two are superscale slumps that involve the entire slope from top to bottom. Steep dips near failure scars and high mean headscarp height of the superscale slumps support the interpretation of strong, cohesive material. Sedimentation, erosion and local geology are controls that determine the location and type of failure.

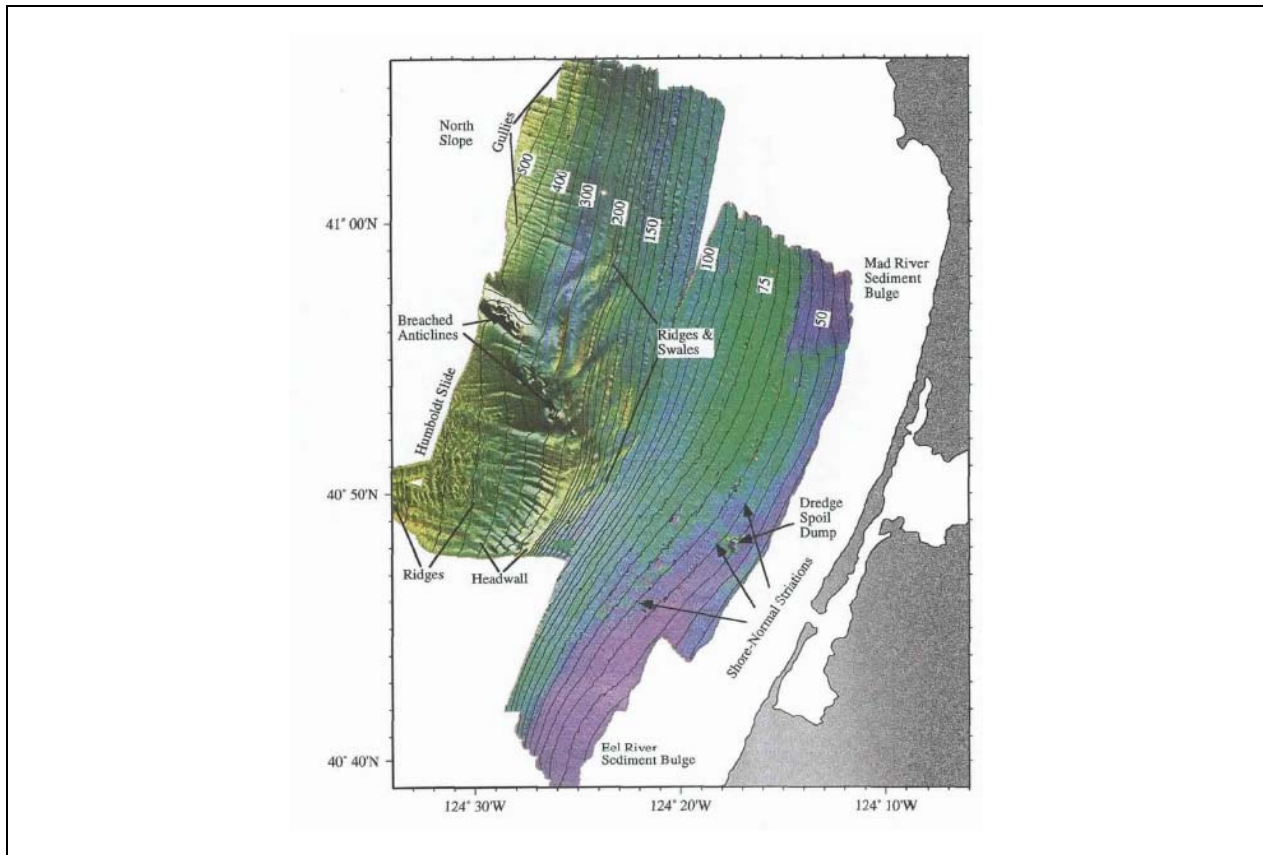

Figure 2.2. The Humboldt Slide complex, offshore the Eel River in Northern California.

Note also the presence of numerous gullies along the slope north of the Humboldt Slide.

From Goff, et al. (1996).

2.3.3 Faulting, Warping, and Deformation

Faulting, warping and rock and seafloor deformation are prevalent in the Northern Study Area, especially north of the MTJ and Fracture Zone and in the southern Cascadia margin. South of the MTJ, in the northern San Andreas Fault area deformation is simple and constrained to the narrow zone of faulting along the right-lateral strike-slip faults that comprise the San Andreas Fault zone in this area (Goldfinger et al. 2008). In the southern Cascadia margin where the Gorda Plate is subducting beneath the North American plate extensive deformation is present on the accretionary wedge here with numerous reverse faults mapped in the offshore, across the continental shelf and trending northwest-southeast (Clarke 1987).

Deformation is so prevalent in the southern Cascadia margin because of the close proximity of the active Gorda Ridge spreading center to the coastline of Oregon, which is forcing the Gorda Plate beneath the North American Plate. Extensive and regular earthquakes occur in this region, generated both by the release of compression along the subducting slab and right-lateral strike-slip motion along the San Andreas Fault and the Mendocino Fracture Zone (Orr and Orr 1996). The front of the accretionary wedge with its folded and faulted compressional ridges is also close to shore here (56 km).

To the north, north of the Blanco Fracture Zone and east of the Juan de Fuca Ridge, which is an active spreading center, the Juan de Fuca Plate is being pushed down along the Cascadia Subduction Zone. Deformation of the frontal accretionary wedge is located further offshore here (~120 km) than in the south (Orr and Orr 1996). Active seismicity is primarily concentrated along the Blanco Fracture Zone where right-lateral motion occurs. Most of the earthquake epicenters associated with the Juan de Fuca Plate subduction are located onshore and have deep (<15 km) focal centers.

Similar to other active volcanic arcs around the Pacific Basin, the Northern Study Area lies predominantly within an active volcanic province. Active volcanism occurs onshore along the North and High Cascades with the volcanic edifices of (from south to north) Mt. Lassen, Mt. Shasta, Mt. McLoughlin, Crater Lake, Mt. Thielsen, Mt. Bachelor, Three Sisters, Mt. Washington, Mt. Jefferson, Mt. Hood, Mt. Adams, Mt. St. Helens, Mt. Rainier, and Mt. Baker representing the most active volcanoes (Orr and Orr 1996). In addition, submarine volcanic activity is present along the Gorda and Juan de Fuca ridges.

2.3.4 Tsunamis

One of the greatest changes in understanding the potential for large-magnitude earthquakes and related tsunamis has occurred as a result of studies of late Pleistocene-Recent sedimentary deposits along the Cascadia Subduction Zone, and correlation with historic tsunamis in Japan. In the late 1970s and early 1980s, the lack of historical earthquakes on the boundary between the Juan de Fuca Plate and the North American Plate was interpreted to be related to smooth plate subduction. By the 1990s a number of studies had concluded that the boundary was locked and was undergoing slip during large (magnitude 8 to 9) earthquakes with a recurrence frequency of several hundred years. The probability of a megaquake (magnitude 9-10) in the next 100 years is 17 percent (Seeman et al. 2008). Ruptures tend to have longer linear extents in the northern Cascadia Subduction Zone than in the southern part (Nelson et al. 2006). Thus, the probability of an earthquake is high, and lengthy ruptures from aftershocks of a megaquake are expected to number in the thousands (Seeman et al. 2008).

Since the turbidite events described by Goldfinger et al. (2008) were generated from large magnitude (M7 and greater) earthquakes, as indicated by the large regional areas affected, it appears reasonable to assume that a tsunami could have been associated with each these events and that the recurrence intervals determined for the events could also be used as locally generated tsunami recurrence intervals. Therefore, based on Goldfinger et al. (2008) findings, the periodicity of locally derived tsunami in the southern part of the Northern Study Area, in the vicinity of the Mendocino Triple junction (northern San Andreas Fault-southern Cascade subduction zone), is somewhere between ~200 to ~220 years while the estimated rate for the entire Cascadia margin is ~520 years. The 1992 Cape Mendocino thrust earthquake (M7.1) did not cause surface rupture, but did cause general coastal uplift and a tsunami (Oppenheimer et al. 1993).

Research initiatives, such as the National Science Foundation Ocean Observatories Initiative (OOI) will provide more information on the Cascadia subduction zone from an extensive cable

(Figure 2.3) from Pacific City, Oregon to the Juan de Fuca Ridge, then south along the Cascadia subduction zone to Hydrate Ridge. The fiber optic cables of the Regional Scale Nodes will carry up to 200 kW of power and up to 240 Gbits/sec on bandwidth for scientific work. The lifetime of the array is expected to be 25 years. (Source <http://www.ooi.washington.edu/>).

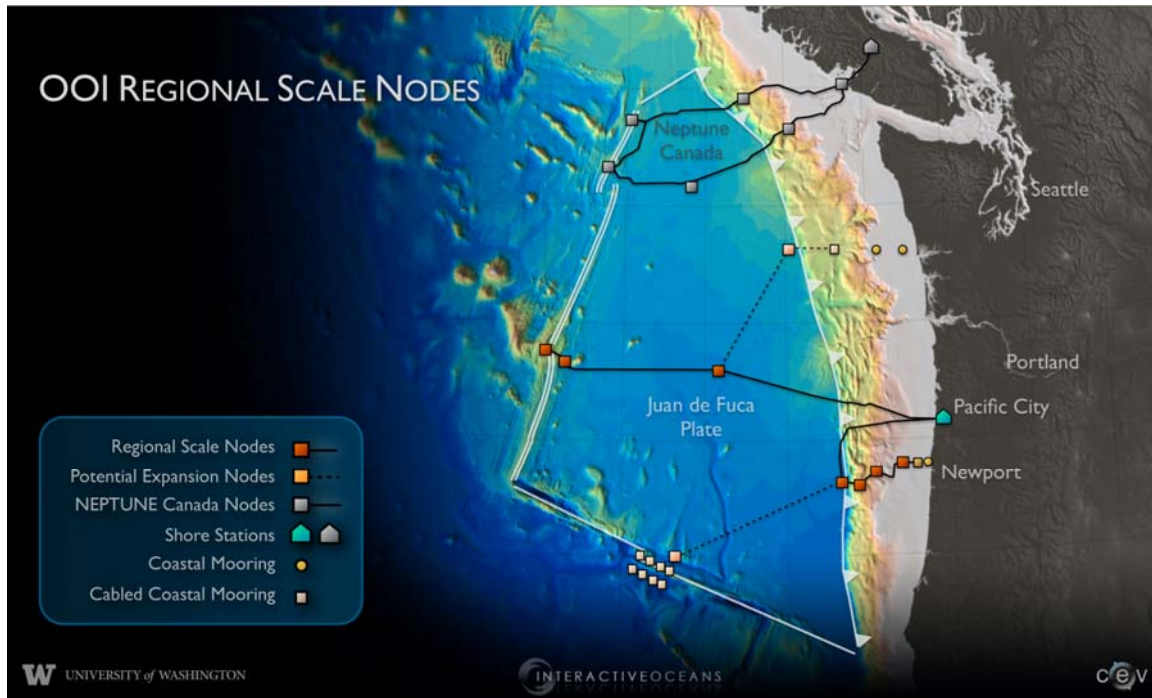

Figure 2.3. A diagram of the Cascadia Subduction Zone showing the Ocean Observatories Initiative planned systems in the Pacific Northwest.

From Ocean Observatories Initiative Regional Scale Nodes program and Center for Environmental Visualization, University of Washington (www.interactiveoceans.washington.edu)

In addition, potentially tsunami-generative conditions are greater off the southern coast of Oregon than off the northern coast, as are the mass wasting conditions, as indicated by the two super-scale slumps present there. These two large slumps were likely tsunami-generative, although they have not been tied to specific earthquakes or to a tsunami event or deposit (MacAdoo and Watts 2004). The apparent age of the super-scale slumps suggests they may have formed during Pleistocene sea level rise (MacAdoo and Watts 2004). The favorable coincidence of orientation of underlying structures, the relatively steep slope, and the cohesiveness of sediment in the southern region appear to set the stage for the generation of large slumps and tsunamis (MacAdoo and Watts 2004). Atwater (1987) reports upon sediments that may have been deposited during the Holocene from tsunamis generated by great subduction-related earthquakes within the Cascadia Subduction Zone complex.

2.3.5 Fluid and Gas Expulsion (Overpressure Zones)

The accretionary zone at the base of the continental slope offshore of Oregon and Washington consists of a series of north-south thrust-faulted ridges (Kulm et al. 1986). Some of the accretionary ridges and breached anticlines offshore of Oregon contain chemotherms, associated with methane seeps and hydrate disassociation, which contribute to the carbon flux into the ocean (Carson et al. 2003). Not all of the fluid expulsion is related to hydrates, however; much of the fluid venting or seeping may be related to shallow or deep sediment dewatering of marine sediment, often through pathways developed along faults (Johnson et al. 2003).

Offshore of Northern California at the western edge of the Eel River Basin, the pockmarked geomorphology of the continental margin below about 400 m indicates considerable gas or fluid expulsion, and considerable sediment redistribution, perhaps related to the presence of underlying hydrates (Yun et al. 1999). The continental shelf shallower than 300 m contains a few pockmarks (Yun et al. 1999), except immediately landward of the head of small gullies near the uppermost slope. These pockmarks are about 100 m in diameter; their origin may be associated with gully formation (Goff et al. 1996).

2.3.6 Irregular and Hummocky Topography

Although little has been reported in regard to irregular and hummocky topography in the Northern Study Area, it is reasonable to expect that because of the compressional tectonics of the region related to the Cascadia subduction zone and gentle-to-steep slopes that dip into the Cascadia Basin, irregular and hummocky topography would exist along the offshore accretionary wedge. Also, unstable sediment associated with river deltas could have produced irregular and hummocky topography. For example, Field et al. (1982) report upon irregular topography associated with a gentle (0.25°) slope on the Klamath River delta offshore Northern California. This topography is composed of scarps and waves that appear to relate to a seismically generated mass failure. Other areas of irregular and hummocky topography are reported to exist along the shallow Oregon coast and are related to eroded bedrock (Parmenter and Bailey 1985).

2.3.7 Rilling, Gullying, and Sediment Transport

No reports describing the development of rills and gullies have been found for the Northern Study Area. However, based on the geologic setting and with ample organic-rich sediment supply from the major rivers debouching onto the continental shelf and a compressive tectonic regime, it seems logical that fluid flow necessary to form such features is present (Eichhubl et al. 2002). Concentrations of gullies along the accretionary front, on the continental slope, in the Gorda Plate and northern Juan de Fuca Plate subduction zones have been mapped (Goldfinger et al. 2008). Also, gullies and rills might be found near Hydrate Ridge (Weitemeyer et al. 2006). In the southern part of the Northern Study Area, in the vicinity and west of the San Andreas Fault, a series of gullies are found that may be associated with fluid flow processes associated with transpression that occurs just southwest of the MTJ (Goldfinger et al. 2008).

Sediment transport in the Northern Study Area consists predominantly of littoral drift and down canyon transport. In the southern part of the study area the continental shelf is narrow (on the

order of 40 km wide just north of Point Reyes and 20 km wide near Cape Mendocino), with Noyo Canyon cutting into the distal continental shelf and the many heads of Viscaino Canyon cutting deeply into the continental shelf (Goldfinger et al. 2008). Although no major rivers enter the ocean here, the high concentration of canyons and gullies just south of the MTJ and Mendocino Fracture Zone indicates considerable transport of sediment to the deep sea here (Goldfinger et al. 2008).

Sediment is transported to the Gorda Basin via Eel, Trinidad, Klamath, Smith and Rogue submarine canyons (Goldfinger et al. 2008). No distinct submarine fan exists here, probably because most of the sediment is being folded into the accretionary wedge as fast as the major rivers and submarine canyons of the southern Cascadia subduction margin can supply the material. Conversely, sediment being transported through Astoria, Willapa, Quinault, Juan de Fuca, and Barkley submarine canyons in the northern part of the Cascadia subduction margin has formed the large Astoria and Nitinat submarine fans (Orr and Orr 1996). The Cascadia Channel separates the two fans, cutting through the Blaco Fracure Zone to supply sediment to the Tufts Abyssal Plain.

Rogue Canyon is the only major submarine canyon that can transport substantial sediment to deep sea, and none exist that can transport sediment to the Cascadia Basin. Sediment supplied to the Oregon continental shelf is partially blocked in its transport to the deep sea behind (east) of Heceta, Perpetua, Stonewall, and Nehalem banks (Orr and Orr 1996). A major littoral cell exists between Astoria Canyon (mouth of Columbia River) in the north and the Rogue Canyon (Rogue River) in the south, just south of Cape Blanco.

Because of the relative steepness of the Washington Shelf north of the Columbia River, subaerial sand barriers are easily drowned or eroded. Stolper et al. (2005) concluded that the gradient of a nonerodible substrate controls coastal evolution by defining the sediment volume required to maintain the equilibrium profile. In addition, ENSO years generate higher, more energetic waves from the southwest and higher water levels along the coast, which increase beach and shoreline erosion, as documented for Willapa Bay (Morton et al. 2007).

Marine seismic-reflection profile studies and modeling of sedimentation north of the Columbia River indicate that the first major deposition of sediment on the shelf since the last lowstand occurred about 12.9 ka in conjunction with the Missoula floods. This was followed by a period of very low sediment input to the shelf from 12.4 to 9.1 ka, and a third period (9.1 ka to recent) when most sediment was added (Stolper et al. 2005). Anthropogenic and other changes appear to have reduced the late Holocene sediment load of 21 million tons/year to the current 5 million tons/year (Wolf et al. 1999).

Fine silt from the Columbia and smaller rivers dominates the sediment types found on the continental shelf of the Cascadia Basin. Local erosion of coastal areas and of Tertiary outcrops on the shallow inner shelf (particularly during winter storms) also contributes to the supply of sediment. The distal shelf is far from the direct influence of rivers and coastal erosion, therefore the bottom is dominated by relict sediments (de Haas et al. 2002)

The Columbia River is the second largest river in the United States, with a current annual sediment load of 5 million tons/year, and it has the fourth largest drainage basin (Baker 2002; Wolf et al. 1999). Surface currents along the shelf flow north during the winter and south during the summer and autumn (Wolf et al. 1999). During summer, sediment from the Columbia River sweeps southwestward, off the Oregon Continental Shelf. During winter, characterized by high water levels and high sediment loads in the Columbia, part of the bedload as well as some sediment transported northward from the Oregon and California Shelves, is deposited on the Washington Shelf, north of the mouth of the Columbia River. Sediment transported directly from the Columbia River forms two lobes, bisected by Astoria Canyon (Wolf et al. 1999). The northwestern lobe has the greater sediment accumulation. Silty sediment accumulates as an elongate bar below a depth of 90 m, and thins from the Columbia River to the head of the submarine Quinault Canyon, some 25 km from shore. Once in the canyon, sediment tends to accumulate until disturbed by seismic activity, which appears to have a recurrence interval of about every 300-600 years. In addition to transport by currents and gravity, storm waves destabilize, suspend, and move sediment off the shelf and onto the slope or into submarine canyons on a yearly to decadal time scale.

North of the anticlines that border the Humboldt slide of Northern California, a series of linear slope gullies, spaced 100-1,000 m apart, and with depths of a few meters, head at the shelf edge. These gullies appear to have formed during glacioeustatic lowstands and filled (buried) during highstands. Thus, the gullies do not appear to be growing headward at present (Burger et al. 2003), but instead are being filled and draped by turbidity flows of sediments from the Eel and Mad Rivers (Goff et al. 1996).

In general, tectonic activity (earthquakes and uplift); weak, erodable bedrock; oversteepened slopes; and high, orographically-induced rainfall along the Northern California Coast produce high rates of mass wasting, erosion, and high sediment bedload in rivers and streams. Thus, this region delivers to the sea one of the highest point sources of fluvial sediment volumes in North America: an estimated $30-40 \times 10^6$ tons /year (Sommerfield and Wheatcroft 2007). The sediments of the shallow shelf of Northern California are dominated by sand; the sediments below depths of 55 to 76 m grade to silt and clay. Active mobilization of sediment extends to at least 60 m of water depth (Ogston and Stenberg 1999). Cross-shelf transport is strongly controlled by antecedent geomorphology reflected in folds expressed on the sea floor. The highest rates of sediment transport occur in structural lows of the middle shelf; lowest transport rates occur at structural highs and at the shelf edge (Sommerfield and Wheatcroft 2007). Fine-grain sediment accumulation on the midshelf offshore of major rivers, including the Eel, appears to have accelerated about six- to elevenfold since 1950 (Sommerfield and Wheatcroft 2007). Following flood season (January-April), considerable sediment reaches the upper part of the Eel Submarine Canyon, although sediment appears to accumulate there year-round. Gravity-driven sediment flows occurring once the angle of repose has been reached or during storm events may be an important mechanism for the transport of these sediments down canyon (Mullenbach and Nittrouer 2000).

2.4 SUMMARY AND DATA GAPS

In general, the physiography of the Northern Study Area consists of low relief coastal ranges onshore, and a continental shelf of highly variable width. Submarine canyons deliver river-derived, generally fine-grained sediment to deep marine basins. The continental slope of the Northern Study Area is generally wider offshore of Washington and Northern Oregon than in Northern California. The whole area is influenced by the tectonic convergence, with accretionary deformation providing structural sea floor expressions, which have been mapped (Snively 1987; Clarke 1987). In Northern California tectonic deformation is controlled by the northward migrating MTJ. Sedimentation in both areas is strongly controlled by the combination of tectonics and glacioeustatic base level changes.

Sedimentation on the Northern California Shelf is dominated by high levels of fine-grained sediment, proximal to rivers that may have increased up to sevenfold since about 1955, due to changes in land use. In areas of low sediment input, the Northern California shelf is characterized by relict sediment, remaining from the last glacioeustatic lowstand. Approximately 75 percent of the sedimentary organic carbon is generated through primary production in the marine environment.

The most prominent depot center or sedimentary basin in Northern California is the Eel Basin, bordered on the south by the Eel Submarine Canyon and on the southwest by the Humboldt Slide. Many of the features in this area, including folds and faults, and the Gordo Escarpment are related to the tectonic activity of the MTJ. Further north, gullies on the continental slope appear to erode during low stands of sea level and fill with fine-grained sediment during sea level highstands, including the present highstand. Pockmarks are associated with a number of these gullies, and are likely related to expulsion of gas or fluid.

If located along an active fault, or at the outermost edge of the continental shelf, sea floor-connected infrastructures constructed on the Northern California Shelf in areas of high sedimentation near rivers would likely be at risk because of earthquakes, mass movement, and sea floor instability due to gas and fluid release from sediments and other such hazards. All of these hazards need to be considered in any sea floor infrastructure development.

Although the Northern Study Area is a low coastal range characterized by variable widths of continental shelf and slope as well as submarine canyons that cut the shelf offshore of major rivers and fault systems, the features offshore of Oregon and Washington differ in important respects from those of Northern California. Among these differences are seasonal changes in the direction of sediment transport across the shelf, and the occurrence of storm-generated waves and currents that erode shorelines and coastal and shallowly submerged Tertiary-aged outcrops.

Submarine canyons in both areas probably erode and enlarge during lowstands, and fill with fine-grained sediment during highstands. Canyons provide temporary storage of sediments being transported to the deep sea floor, and appear to empty every 300 to 500 years, due to sediment instability, likely triggered by seismic activity. Sediment load appears to have increased offshore of Northern California since 1950, but has decreased by 75 percent since the late Holocene along offshore Washington.

The Northern Study Area is generally less studied than the Southern Study Area. This is probably the result of the difference in weather, access, resources, population density, and the existence of research agencies and institutions that study the marine environment. Data that is needed for assessing the geological conditions of this area include, but is not limited to, the following:

- Acoustic bathymetric and backscatter data collection on the continental shelf and upper slope to identify and map geologic structure, sediment dynamics and sites of unstable seafloor;
- Seafloor rock samples for use in determining stratigraphy of bedrock outcrops;
- Construction of seafloor DEMs that can be used in assessing tsunami impacts, sediment transport direction, and types, locations, and elevations of bedrock exposures;
- Identification and mapping of Essential Fish Habitats (ESF);
- Fate and transport of chemical constituents across the continental shelf;
- Erosive processes on the shelf.

Note – Under the West Coast Governors’ agreement to protect the ocean a major effort is underway to map the seafloor for all West Coast state waters. This work is presently underway in California and Oregon but not yet started in Washington. Therefore, additional bathymetric data will become available shortly for the southern part of the Northern Study Area, specifically in the northern San Andreas Fault, MTJ, and southern Cascadia areas. In addition, the USGS will be collecting seismic reflection profiles in the northern San Andreas Fault area and this data along with the bathymetric data should be available in the near future for inclusion in any geologic assessment of the Northern Study Area.

2.5 LIST OF LITERATURE CITED—GEOLOGICAL OCEANOGRAPHY

- Allan, J.C. and P.D. Komar. 2000. Spatial and temporal variations in the wave climate of the North Pacific. Report to the Oregon Dept. of Land Conservation and Development, Salem Oregon. 46 pp.
- Atwater, B.F. 1987. Evidence for great Holocene earthquakes along the outer coast of Washington State. *Science* 236 (4804):942-944.
- Baker, D. 2002. Holocene (2–16 ka) sedimentation in the Columbia River Estuary. Portland State University Masters thesis. 132 pp.
- Burger, R.L., C.S. Fulthorpe and J.A. Austin. 2003. Effects of triple junction migration and glacioeustatic cyclicity on evolution of upper slope morphologies, offshore Eel River Basin, Northern California. *Marine Geology* 199(3-4):307-336.

- Burger, R., C.S. Fulthorpe, J.A. Austin, and S.P.S. Gulick. 2002. Lower Pleistocene to present structural deformation and sequence stratigraphy of the continental shelf, offshore Eel River Basin, Northern California. *Marine Geology* 185(3-4):249-281.
- C-CORE. 2002. Project Offshore Deep Slopes – Phase I. Final Report. Prepared for: Chevron Canada Resources, Pan Canadian, Murphy Oil, ExxonMobile, Minerals Management Services, Norsk Hydro and Statoil. Prepared by: C-CORE, OTRC, GSC and NGI. C-CORE Publication 01-C12.
- Carson, B., M. Kastner, D. Bartlett, J. Jaeger, H. Jannasch and Y. Weinstein. 2003. Implications of carbon flux from the Cascadia accretionary prism: Results from long-term, in situ measurements at ODP Site 892B. *Marine Geology* 198(1-2):159-180.
- Chase, Z., B. Hales, T.J. Cowles, R. Schwartz, and A. Van Geen. 2005. Distribution and variability of iron input to Oregon coastal waters during the upwelling season. *Journal of Geophysical Research* 110(C10S12): 1-14.
- Clarke, S.H., Jr.. 1987. Geology of the California continental margin north of Cape Mendocino. In: Scholl, D.W., Grantz, A. and Vedder, J.G., Geology and resource potential of the continental margin of Western North America and adjacent basins Beaufort Sea to Baja California. Circum-Pacific Council for Energy and Mineral Resources, Earth Science Series, Volume 6. 337-351.
- CPC (Circum-Pacific Council for Energy and Mineral Resources). 1985. Plate Tectonic Map of the Circum-Pacific Region, Pacific Basin Sheet. American Association of Petroleum Geologists, Tulsa, OK, scale 1:17,000,000.
- Davies, M.H. and C.A. Nittrouer. 2006. A thirty-year perspective on Washington Continental Shelf sedimentation: The impact of recent environmental changes. In: American Geophysical Union, Fall Meeting 2006, Abstract # NG43D-1176.
- De Haas, H.T. C.E. Van Weering and H. De Stieger. 2002. Organic carbon in shelf seas: Sinks or sources, processes and products. *Continental Shelf Research* 22(5):691-717.
- De Lappe, B.W., R.W. Risebrough, and W. Walker II. 1983. A large-volume sampling assembly for the determination of synthetic particulate phases of seawater. *Can. J. Fish. Aquat. Sci.* 40:322–336.
- Eichhubl, P., H.G. Greene, and N. Maher. 2002. Physiography of an active transpressive margin basin: high-resolution bathymetry of the Santa Barbara Basin, Southern California Continental Borderland. *Marine Geology* 181:95-120.
- Field, M.E., J.V. Gardner, A.E. Jennings, and B.D. Edwards. 1982. Earthquake-induced sediment failures on a .25o slope, Klamath River Delta, Northern California. *Geology* 10(10):542-546.

- Godfrey, N.J., A.S. Meltzer, S. L. Klemperer, A.M. Trehu, B. Leitner, S.H. Clarke, and A. Ondrus. 1998. Evolution of the Gorda escarpment, San Andreas fault and Mendocino triple junction from multichannel seismic data collected across the northern Vizcaino block, Northern California. *J. Geophys. Res.* 103(B10):23813-23825.
- Goff, J.A., L.A. Mayer, J. Hughes-Clarke, and L.F. Pratson. 1996. Swath mapping on the continental shelf and slope: The Eel River basin, Northern California. *Oceanography* 9(3):178-182.
- Goldfinger, C., L.D. Kulm, L.C. McNeill and P. Watts. 2000. Superscale failure of the southern Oregon Cascadia Margin. *Pure and Applied Geophysics* 157:1189-1226.
- Goldfinger, C., C.H. Nelson, J.E. Johnson, and the Shipboard Scientific Party. 2003a. Deep-water turbidites as Holocene earthquake proxies: the Cascadia Subduction zone and the Northern San Andreas Fault systems. *Annals of Geophysics* 46(5):1169-1194.
- Goldfinger, C., C.H. Nelson, J.E. Johnson, and the Shipboard Scientific Party. 2003b. Holocene Earthquake Records from the Cascadia Subduction Zone and Northern San Andreas Fault Based on Precise Dating of Offshore Turbidites. *Annual Reviews of Earth and Planetary Science* 31:555–77, doi: 10.1146/annurev.earth.31.100901.141246.
- Goldfinger, C., A.E. Morey, C.H. Nelson, J. Gutierrez-Pastor, J.E. Johnson, E. Karabanov, J. Chaytor, and A. Ericsson. 2007. Rupture lengths and temporal history of significant earthquakes on the offshore and north coast segments of the northern San Andreas fault based on turbidite stratigraphy, *Earth Planet. Sci. Lett.* 254, 9–27.
- Goldfinger, C., K. Grijalva, R. Buergermann, A.E. Morey, J.E. Johnson, C.H. Nelson, J. Gutierrez-Pastor, A. Ericsson, E. Karabanov, J.D. Chaytor, J.A. Patton, and E. Gracia. 2008. Late Holocene rupture of the northern San Andreas Fault and possible stress linkage to the Cascadia Subduction Zone: *Bulletin of the Seismological Society of America* 98(2): 861-889.
- Greene, H.G., N.M. Maher, and D.K. Paull. 2002. Physiography of the Monterey Bay National Marine Sanctuary and implications about continental margin development. *Marine Geology* 181:55-82.
- Harlett, J.C. and L.D. Kulm. 1973. Suspended sediment transport to the northern Oregon continental shelf. *GSA Bulletin* 84(12):3815-3826.
- von Huene, R., C.R. Ranero, and D.W. Scholl. 2009. Convergent Margin Structure in High-Quality Geophysical Images and Current Kinematic and Dynamic Models. In *Frontiers in Earth Sciences: Subduction Zone Geodynamics*, Part IV, pp 137-157. Springer, Berlin, doi 10.1007/978-3-540-87974-9_8.
- Johnson, Joel E., C. Goldfinger and E. Suess. 2003. Geophysical constraints on the surface distribution of authigenic carbonates across the Hydrate Ridge region, Cascadia margin. *Marine Geology* 202(1-2):79-120.

- Jones and Stokes. 1981. Ecological characterization of the Central and Northern California Coastal Region. Report to Bureau of Land Management, Pacific Outer Continental Shelf Office and National Coastal Ecosystems Team, Office of Biological Services, Fish and Wildlife Service. Washington, D.C.
- Kulm, L.D., E. Suess, J.C. Moore, B. Carson, B.T. Lewis, S.D. Ritger, D.C. Kadko, T.M. Thornburg, R.W. Embley, W.D. Rugh, G.J. Massoth, M.G. Langseth, G.R. Cochrane and R.L. Scamman. 1986. Oregon subduction zone—Venting, fauna, and carbonates. *Science* 231(4738):561-566.
- Lee, H.J., W.R. Normark, M.A. Fisher, H.G. Greene, B.D. Edwards and J. Locat. 2004. Timing and extent of submarine landslides in Southern California. *Offshore Tech. Conf. OTC Paper Number 15744*.
- MacAdoo, B.G. and P. Watts. 2004. Tsunami hazard from submarine landslides on the OregoContinental Slope. *Marine Geology* 203:235-245.
- Morton, R.A., H.E. Clifton, N.A. Buster, R.L. Peterson and G. Gelfenbaum. 2007. Forcing of large-scale cycles of coastal change at the entrance to Willapa Bay, WA. *Marine Geology* 246(1):24-41.
- Mullenbach B.L. and C.A. Nittrouer. 2000. Rapid Deposition of fluvial sediment in the Eel Canyon, Northern California: *Continental Shelf Research* 20:2191-2212.
- Nelson, A.R., H.M. Kelsey and R.C. Witter. 2006. Great earthquakes of variable magnitude at the Cascadia subduction zone. *Quaternary Research* 65:354-365.
- Ogston, A.S. and R.W. Stenberg. 1999. Sediment-transport events on the Northern California Continental Shelf. *Marine Geology* 154:69-82.
- Oppenheimer, D., J. Eaton, A. Jayko, M. Lisowski, G. Marshall, M. Murray, R. Simpson, R. Stein, G. Beroza, M. Magee, G. Carver, L. Dengler, R. McPherson, L. Gee, B. Romanowicz, F. Gonzales, W.H. Li, K. Satake, P. Somerville and D. Valentine. 1993. The Cape Mendocino, California, Earthquake of April 1992: Subduction at the Triple Junction. *Science* 261:433-438, doi: 10.1126/science.261.5120.433
- Orr, E.L., and W.N. Orr. 1996. *Geology of Oregon*. Kendall/Hunt Publishing Company, Dubuque, Iowa. 254 pp.
- Parmenter, T. and R Bailey. 1985. *Oregon ocean book*. Corvallis, OR: Oregon Department of Conservation and Development and Sea Grant, Oregon State University. 85 pp.
- Prahl, F.G., E. Crecellus and R. Carpenter. 1984. Polycyclic aromatic hydrocarbons in Washington coastal sediments: An evaluation of atmospheric and riverine routes of introduction. *Environmental Science & Technology* 18(9):687-693.

- Pratson, L.F. and W.F. Haxby. 1996. What is the slope of the U.S. Continental Slope? *Geology* 24(1):3-6.
- Reid, J.A. and W.R. Normark. 2003. Tufts submarine fan: Turbidite-current gateway to Escanaba Trough. *USGS Bulletin* 2216. 23.
- Seemann, M.R., T. Onur and J.F. Cassidy. 2008. Seismic hazard resulting from aftershock activity following a cascadia subduction earthquake. In: *Proceedings of the 14th World Conference on Earthquake Engineering*. Beijing, China, October 12-17, 2008.
- Shum K.T. and B. Sundby. 1995. Organic matter processing in continental shelf sediments: The subtidal pump revisited. *Marine Chemistry* 53(1-2):81-87.
- Sommerfield, C.K. and R.A. Wheatcroft. 2007. Late Holocene sediment accumulation on the Northern California Shelf: Oceanic, fluvial, and anthropogenic influences. *Geological Society of America Bulletin* 119(9-10):1120-1134.
- Snavely, P.D., Jr. 1987. Tertiary geologic Framework, neotectonics, and petroleum potential of the Oregon-Washington continental margin. In: Scholl, D.W., Grantz, A., and Vedder, J.G.. *Geology and resource potential of the continental margin of Western North America and adjacent Beaufort Sea to Baja California*. Circum-Pacific Council for Energy and Mineral Resources, Earth Science Series, Volume 6. 305-335.
- Stolper, D., J.H. List and E.R. Thieler. 2005. Simulating the evolution of coastal morphology and stratigraphy with a new morphological-behaviour model (GEOMBEST). *Marine Geology* 218(1-4):17-36.
- Weitemeyer, K.A., S.C. Constable, K.W. Key and J.P. Behrens. 2006. First results from a marine controlled-source electromagnetic survey to detect gas hydrates offshore Oregon. *Geophysical Research Letters* 33: L03304, doi:10.1029/2005GL024896.
- Whitmore, P.M. 2003. Tsunami amplitude prediction during events: a test based on previous tsunamis. *Science of Tsunami Hazards* 21:135-143.
- Whitmore, P.M., H. Benz, M. Bolton, G. Crawford, L. Dengler, G. Fryer, J. Goltz, R. Hanson, K. Kryzanowski, S. Malone, D. Oppenheimer, E. Petty, G. Rogers and J. Wilson. 2008. NOAA/West Coast and Alaska Tsunami Warning Center Pacific Ocean Response Criteria, *Science of Tsunami Hazards* 27:1-21.
- Wolf, S.C., H. Nelson, M.R. Hamer, G. Dunhill and R.C. Phillips. 1999. The Washington and Oregon midshelf silt deposit and its relation to the Late Holocene Columbia River sediment budget. *USGS Open File* 99-173.
- Yun, J.W., D.L. Orange and M.E. Field. 1999. Subsurface gas offshore Northern California and its link to submarine geomorphology. *Marine Geology* 154:357-368.

3. CHEMICAL OCEANOGRAPHY AND GEOCHEMISTRY

The chemical composition of seawater is dominated by terrestrial and atmospheric inputs to the ocean and the vertical distribution of chemicals in the water column. Human activities can and do alter natural biogeochemical processes, which are linked to the chemical composition of the ocean, particularly at coastal margins. Inputs that are influenced by human activities generally enter the ocean from the land as either point or nonpoint sources.

There are three main hypotheses that explain the chemical composition of the ocean: (1) *accumulation*, where the ocean represents the accumulated inflow from rivers and the atmosphere; (2) *kinetic control*, where the composition is a balance of these external inputs and the rate of removal (primarily biological processes), and (3) *equilibrium*, where composition is controlled by equilibria between seawater and chemical precipitates, lithogenic particles, and the ocean crust. The crucial role of removal mechanisms and rate constants for each chemical suggests that the most appropriate chemical composition hypothesis is a hybrid of the kinetic control and equilibrium mechanisms (Sarmiento and Gruber 2006).

The fate of chemicals released to ocean water in the Northern Study Area includes transport to the North Pacific, deposition into sediments, loss to the atmosphere, bioaccumulation in the marine food web, as well as in-situ chemical and biological transformation.

Extensive research to characterize continental shelf chemistry within the Northern Study Area was conducted during the 1960s and '70s. Information on the Washington/Oregon coast was summarized by the Oceanographic Institute of Washington (1977) and continues to serve as a historical body of knowledge for the oceanic chemistry within this region.

Over the last several decades, new knowledge has been added to the understanding of the chemistry of the Northern Study Area. New analytical tools have supported better definition of marine biogeochemical cycles. Those tools include analytical techniques for the quantification of ultra low levels of trace metals such as iron, the evolution of numerical model simulations of chemical cycles, and remote sensing platforms and algorithms for measuring surface water chemistry. Research to understand the causes and effects of hypoxia in coastal waters has provided new insights into the interaction between natural cycles and human inputs. Studies of anthropogenically driven climate change impacts have provided new insights into ecosystems in the coastal ocean, and large-scale climatic events such as the Pacific Decadal Oscillation and El Niño Southern Oscillation (ENSO) have been better documented.

The following three sections of this chapter summarize these new research findings as they apply to the Northern Study Area since the 1977 Oceanographic Institute publication. The first section describes the sources of organic matter and trace elements to the region, both natural and anthropogenic. The second section updates the knowledge of water column processes that impact the distributions of chemicals in the study region, with an emphasis on the dynamics of natural systems. The third section examines the distribution and fate of chemical constituents, including organics and trace metals.

3.1 SOURCES OF ORGANIC MATTER AND TRACE ELEMENTS

Chemicals found in the study region can arise from numerous sources. Autochthonous sources are driven by primary production, which is often prolific in the upwelling regime of the California Current System. Allochthonous sources of chemicals include transport by currents into the study area, atmospheric deposition to the sea surface, release from underlying sediments or bedrock, and flux from land.

3.1.1 Autochthonous Sources

Organic matter in the water column and surface sediments of the coastal ocean is made up of particulate organic matter (POM) and dissolved organic matter (DOM). POM is generally defined as all particles larger than about 0.5 μm ; smaller particles and molecules are considered DOM. The concentration of DOM is many times that of POM (Parsons et al. 1984). POM is made up largely of detrital material and living cells and reaches up to 250 mg C/L in the surface waters of the Northern Study Area (Volkman and Tanoue 2002). Dead and damaged cells of phytoplankton, zooplankton moults and fecal pellets, and marine bacteria are the sources of most detrital POM. Leakage from phytoplankton cells, “sloppy” eating and excretory products by zooplankton, and lysed bacteria and flagellate cells make up almost all DOM found in the water column (Parsons et al. 1984). In the Columbia River, during spring and summer, phytoplankton blooms primarily contribute to POC and suspended particulate matter (SPM) that enter the estuary, while in winter organic matter is primarily allochthonous, most likely from soil erosion (Sullivan et al. 2001). Primary production in the Northern Study Area is controlled by the availability of light for plant growth and the resupply of nutrients to surface waters by deepwater upwelling. The summertime inflow of saline water onto the inner shelf is one means by which the slope and basin communicate directly with the inner shelf (Goes et al. 2001). Wind-driven upwelling of nutrients from deeper layers fuels autochthonous organic matter production, resulting in fluctuations in the biomass of plankton on the order of days. Plankton community structure plays a key role in controlling the recycling and export of organic matter in the photic zone. It is now widely recognized that small organisms such as picoplankton (less than 3 μm) can be major components of the plankton in many oceanic regimes, thus extremely important to the food web structure and stability (Volkman and Tanoue 2002).

There have been few data collected that delineate the input and cycling of autochthonous carbon input into the Northern Study Area since 1977. The major exception is the California Cooperative Ocean Fisheries Initiative (CalCOFI) program that has collected data quarterly, occupying a transect of stations off Newport, Oregon (Lynn et al. 1998).

More detail on the dynamics of phytoplankton blooms, phytoplankton/zooplankton interactions, and other biological constituents that control autochthonous sources of chemicals in the Northern Study Area can be found in [Chapter 4](#).

Most autochthonous material in the Northern Study Area consists of benign living and recently living organisms. However, neurotoxins produced by certain phytoplankters can cause debility and death for mammalian and avian predators such as sea lions, pelican, and humans (Trainer et al. 2002). These biotoxins include domoic acid and paralytic shellfish poisoning (PSP). Domoic acid is produced by the diatom *Pseudonitzschia* sp. and is then advected to the shelf and

nearshore areas of Washington, Oregon, and Northern California. PSP is produced by the dinoflagellate *Alexandrium catenella* directly into inshore waters (Trainer et al. 2002).

Climatic events strongly impact primary productivity, which in turn impacts the sources and distribution of autochthonous organic material to the study region. More information can be found in [Chapter 1 Physical Oceanography](#). El Niño/La Niña events provide one such example of direct relevance the study area (Lynn et al. 1998). Changes in ocean circulation and resulting changes in regional surface water temperature and upwelling strongly impact primary production. During the very large 1997-1998 ENSO event, a warm water lens was detected hugging the coast of the Northern Study Area, inhibiting seasonal upwelling and decreasing primary production. More detail on the effects of climatic events on primary productivity can be found in [Chapter 4](#).

In the Northern Study Area the coupling between ocean and estuary is central to the function of the estuary, because the ocean, rather than local rivers, is the dominant source of nutrients fueling primary production in the coastal plains estuaries because the local river inputs are at a minimum during the warm/dry season (Hickey and Banas 2003 and references therein). The Columbia River dynamics can lead to asymmetries between Oregon and Washington estuaries during strong downwelling favorable winds, while during spring and summer, the more spatially coherent winds lead to increasing similarity among the coastal plains estuaries. However, even the small coastal rivers characteristic of Oregon and Northern California can significantly alter coastal biogeochemical cycles and influence ecosystem structure (Wetz et al. 2006).

3.1.2 Allochthonous Sources

Allochthonous compounds found in the Northern Study Area include both organic and inorganic compounds and originate from a variety of sources, including natural terrestrial and sediment sources, as well as a small input from anthropogenic sources.

Major rivers (rivers with high sediment or water discharge rates) play a significant role in transporting dissolved and particulate materials from terrestrial environments to the coastal ocean. Allochthonous matter includes both lithogenic and watershed-derived biogenic particles. This large terrestrial input greatly influences the magnitude of biogeochemical process rates in the benthic boundary layer (BBL) and seabed of adjacent continental margins. In the Northern Study Area, the largest source of allochthonous inputs is the discharge from the Columbia River, which varies seasonally from 2,500 to 17,000 m³/s and can reach 30,000 m³/s in major freshets, accounting for approximately 77 percent of the coastal drainage and 90 percent of the freshwater input between the Strait of Juan de Fuca and San Francisco Bay (Barnes et al. 1972). Thomas and Weatherbee (2006) document the Columbia River as the largest river along the western U.S. and provide temporal variability using satellite information.

3.1.2.1 Organic Compounds

Organic compounds entering the waters of the Northern Study Area are carried as living organisms and detritus by rivers and streams, with some contribution from methane seeps and deposits ([see chapter 2 for further detail](#)) and from anthropogenic sources. There are few direct emissions of industrial material, including manufactured organic compounds, directly into the

marine environment because much of the coastline of the Northern Study Area is relatively unpopulated. The NOAA National Status and Trends Mussel Watch Program monitors and reports on concentrations and trends in approximately 140 contaminant analytes in the coastal U.S. and Great Lakes. The 2008 Report “Mussel Watch: An Assessment of Two Decades of Contaminant Monitoring in the Nation’s Coastal Zone” (Kimbrough et al. 2008a) covers 1986-2005. Of the 17 metals and metalloids, the most accurate extensive data set is available for arsenic, cadmium, copper, lead, mercury, nickel, tin and zinc. Of the organic contaminants, 65 PAHs are quantified. PBDEs are being studied using archived tissue and current sampling (Kimbrough et al. 2008b). Within the Northern Study Area there are 27 monitoring sites that vary from bays and estuaries to the open coast. Though many of the coastal areas of the Northern Study Area are primarily pristine, locations of higher contaminant levels are available through the Mussel Watch program.

The plume from the Columbia River is thought to have major ecological effects in the Northern Study Area, particularly with respect to out-migrating juvenile salmon (Pearcy 1992). River discharges onto ocean margins, not just the Columbia, are dynamic and significant in that they allow greater amounts of carbon processing than other systems, are major repositories of carbon and sediment, and are one of the most important active sites of organic matter burial on the earth’s surface (McKee et al. 2004; Wetz et al. 2008).

3.1.2.2 Inorganic Compounds

In addition to organic material, numerous inorganic compounds also enter into the study area. Five general classes are considered here, including nutrients, dissolved oxygen, inorganic particulate material, trace metals, and sulfur compounds.

Wetz et al. (2006) measured the input of macronutrients and certain micronutrients, such as iron, from coastal rivers in Oregon and estimated that the input from winter and spring runoff is sufficient to support phytoplankton growth through to the following spring and summer until upwelling brings new nutrient-rich water to the surface ([Figure 3.1](#)). In addition, essential micronutrients, such as iron, are supplied by winter flooding from rivers. The narrow shelf off Washington and Oregon allows the riverine input to spread across the shelf as winter winds relax. The winter riverine input and narrower shelves prevent the widespread iron limitation that is seen off the California shelf (Wetz et al. 2006), though Frame and Lessard (2009) observed potential iron limitation after an unusually early spring upwelling event and diatom bloom. The results of the River Influences on Shelf Ecosystems (RISE) program indicate that coastal rivers can alter coastal biogeochemical cycles (see Hickey et al. 2010 for synthesis). The riverine mud deposits midshelf appear to act as an “iron capacitor” charged by winter floodwaters that are high in sediment, and discharged during summer upwelling. In the Northern Study Area:

- California: iron can be limiting (Hutchins and Bruland 1998; Hutchins et al. 1998; Bruland et al. 2001; Firme et al. 2003);
- Oregon: iron is not limiting (Chase et al. 2002); and

- Washington: iron is generally not limiting (Kudela and Peterson 2009; Lohan and Bruland 2006, 2008; Bruland et al. 2008).

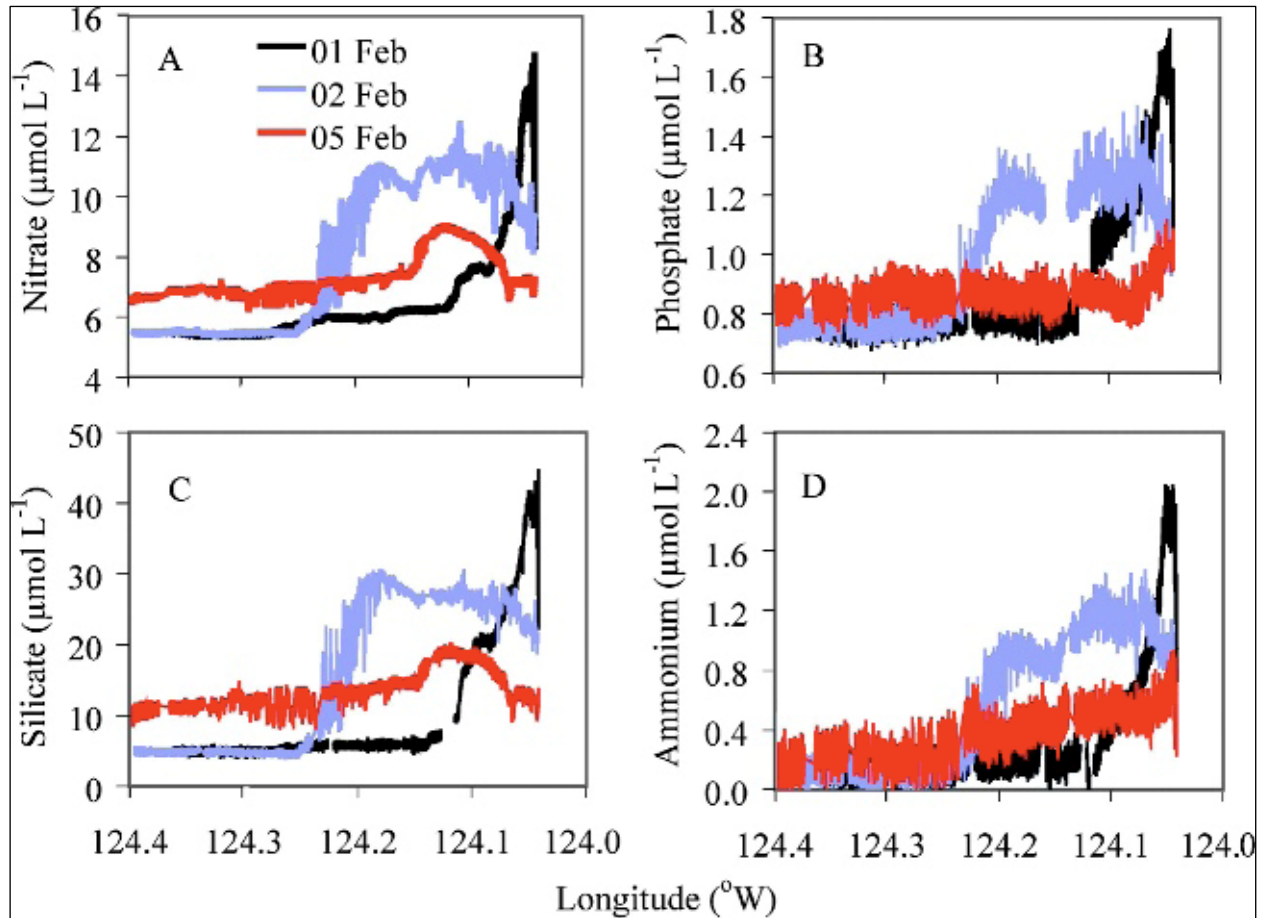

Figure 3.1. Distributions of (A) nitrate, (B) phosphate, (C) silicate, and (D) ammonium in surface waters off the coast of Oregon during February 2003, supplied by coastal rivers including the Columbia River.

The Oregon coast is to the right (long. 124° W). Elevated concentrations of macronutrients appear close to the river discharge and decrease as the plumes cross the shelf.

Source: Wetz et al. (2006).

3.1.2.2.1 Nutrients

Primary producers such as phytoplankton require dissolved inorganic macronutrients, including forms of nitrogen and phosphorus (most commonly nitrate, NO_3 ; nitrite, NO_2 , or ammonia, NH_4 ; and phosphate, PO_4) to grow. Diatoms, the dominant phytoplankton in the Northern Study Area, also need silica (usually silicate- SiO_2) to form their shells. In addition, primary producers require micronutrients that include various metals and organic compounds. When phytoplankton exhaust a particular macro- or micronutrient, that nutrient becomes the limiting growth factor, and the availability of that nutrient becomes limiting to the phytoplankton community.

The waters of the Northern Study Area are generally replete with the macro- and micronutrients required for plankton growth; however, following large algal blooms, nutrient deficits may occur. The primary source for nitrogen, phosphorus, and silicate nutrients in waters over the shelf is deeper water (approximately 200 m) that upwells onto the shelf during upwelling-favorable winds. During spring, summer, and early fall when sufficient light exists, phytoplankton reduce nutrient levels in the surface waters, until one nutrient becomes limiting. While upwelling continues, a renewable source of macronutrients is available to the phytoplankton. Once upwelling ceases or light levels become too low, the phytoplankton cease to grow. On the Oregon shelf, new measurement techniques (Hales et al. 2005a) show that in addition to the classical upwelling / downwelling cycles, continuous vertical turbulent mixing irreversibly moves net upwelled nitrate from shallower waters into waters deeper than 30 m, even during relaxation periods. A more general discussion of the unique features in the Washington coast leading to higher productivity than in areas with higher wind stress such as Northern California can be found in Hickey and Banas (2008). Physical features do play a role in retention, such as wider shelves, coastlines without capes, and a large bank. Other factors include the dynamics of the Columbia River plume.

Typically, nitrogen compounds (nitrate, nitrite, and/or ammonia) become the limiting nutrient. However, it has been shown that in open-ocean and shelf environments, phytoplankton may be limited by the availability of iron. Most iron enters the ocean from terrestrial sources, carried by rivers and streams (Bruland et al. 2001; Wetz et al. 2006). The Bruland study found that north of Point Sur, California the annual input of riverine iron during the winter high-discharge events was deposited in shelf sediments. During upwelling events, these sediments are mobilized and the iron in them supports phytoplankton productivity. South of Point Sur, the shelf is very narrow and there is less riverine discharge, but the upwelled water has high nutrients and low productivity, which the Bruland study attributed to a lack of iron ([Figure 3.2](#)). Conversely, in the waters off northern Oregon, Wetz et al. (2006) found that the winter riverine discharge of nutrients into coastal waters could result in winter carbon fixation (plankton blooms), equating to around 20 percent of the summer upwelling carbon fixation. Rivers in northern Oregon contribute enough iron to support phytoplankton growth at a low level throughout the winter, and they sequester enough iron over the shelf for the following spring and summer blooms (Wetz et al. 2006).

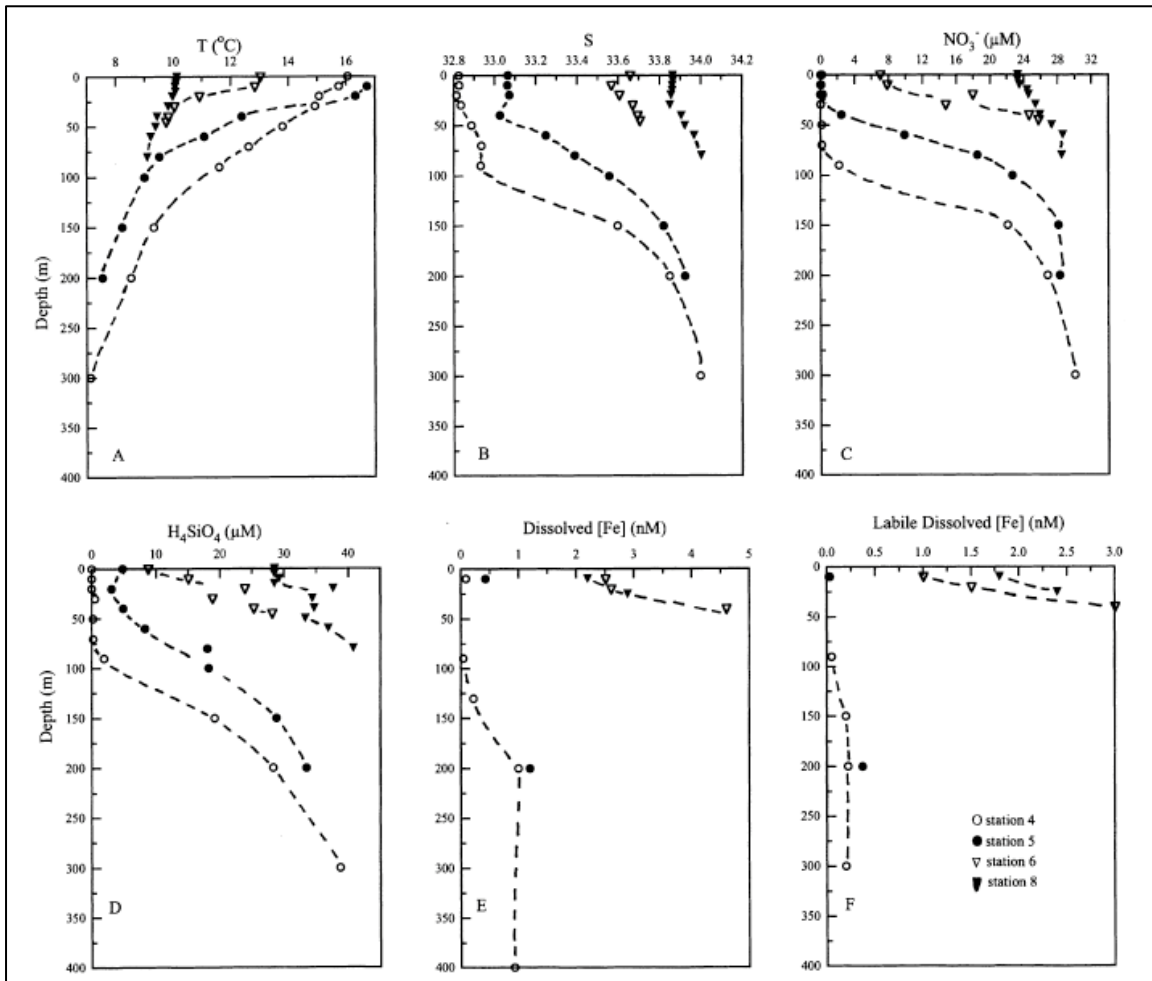

Figure 3.2. Vertical profiles of (A) temperature, (B) salinity, (C) nitrate, (D) silicic acid, (E) total dissolved Fe, and (F) labile dissolved Fe in the upper 300 m of the water column at a series of stations beginning offshore in the middle of the California Current (Sta. 4), in transition waters (Sta. 5), and continuing onshore into active coastal upwelling areas (Sta. 6 and 8) for a transect approximately along CalCOFI line 67.

Source: Bruland et al. (2001).

In the Northern Study Area, nutrient cycling and associated organic matter production is driven primarily by large-scale upwelling that brings dissolved nutrients to the surface, as well as by mixing caused by mesoscale features, such as variations in shelf width or slope, the Columbia River plume, the San Francisco Bay plume, the semipermanent eddy offshore of the Strait of Juan de Fuca, and submarine canyons (Hickey et al. 2010; Hickey and Banas 2008; Hickey and Banas 2003; Barth et al. 2005). The continental shelf off Washington is wide and gently sloping, possibly allowing the upwelling of water from deeper layers that is richer in nutrients than water upwelled off Oregon's narrower shelf. Physical features may have important effects on the magnitude and timing of macro- and micronutrient delivery to the plankton, which may in turn affect the transport pathways and residence times of planktonic larvae and potentially the development of harmful algal blooms (Hickey and Banas 2009; Hickey and Banas 2003).

Phytoplankton typically take up nitrate as their primary nitrogen source, followed by nitrite and ammonia (Parsons et al. 1984). However, other forms of dissolved organic nitrogen, including urea, creatine, and certain amino acids, also fuel primary production through symbiotic bacterial pathways (Bronk et al. 2007). Theories have been put forward that the presence of certain dissolved nitrogenous compounds may favor harmful algal bloom (HAB) organisms (Bronk et al. 2007).

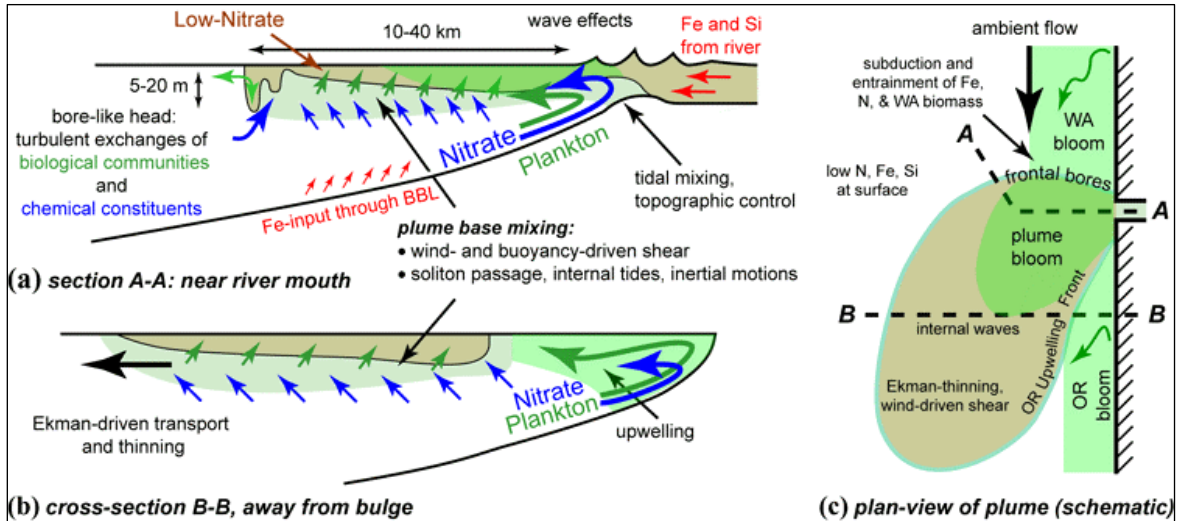

Figure 3.3. Cartoon of the processes involved in the Columbia River Plume.

Processes are: mixing (black curved arrows), fluxes (one-way flux uses a single arrow; two-way fluxes use double arrows), black arrows are advection; flux parameters are iron (red), phytoplankton (green) and nitrate (blue); biomass transport is green and blue tracks with arrowheads.

Source: Hickey et al. (2010).

Nitrate input to the ocean from coastal rivers in the Northern Study Area is relatively small, even from the Columbia River (Conomos et al. 1972; Lohan and Bruland 2006). Nitrate limitation is observed in aging Columbia River plumes (Hickey et al. 2010). However, the Columbia River plume is an important source of micronutrients (e.g., iron, dissolved manganese, and silicic acid) to the inner shelf (Buck et al. 2007; Berger et al. 2008; Aguilar-Islas and Bruland 2006). Hickey and Banas (2003) hypothesized that the water column iron would be more labile north of the river mouth. Observations of dissolved and labile iron in plume sediments indicate a riverine source in the spring, and increasingly marine seabed source through the summer (Bruland et al. 2008). The Columbia River plume shifts seasonally and with the wind (Landry et al. 1989; Hickey et al. 2005, 2008) from southwest during upwelling conditions, transitioning to the Oregon coast with a northward jet developing as the winds transition to downwelling conditions, then the northward jet moving offshore and mixing as the winds transition to upwelling conditions and the redevelopment of the southwest plume. The plume chemistry varies seasonally and with oceanographic conditions, tidal phase, and river flow (Nash et al. 2009; Bruland et al. 2008).

The primary source of iron is thought to be storm-driven transport of fine sediments from the Columbia River mouth northward, producing a 10-m-thick deposit of silt over the mid- and outer shelf along the entire Washington shelf (Nittrouer 1978). Columbia River plume increases entrainment of inner shelf water across the 100 m isobath, and disrupts the flow of inner shelf water southward, leading to enhanced retention of these inner shelf waters north the Columbia River (Banas et al. 2009). In addition, the relatively wider Washington shelf would allow more continuous sediment and water interface and would enhance the potential for resuspending particulate iron off the Washington coast. Bruland et al. (2001) also found shelf sediment may be the primary source of iron during upwelling events off the California coast. Additional research is needed to determine if the Northern Study Area is truly iron-limited and what role micronutrients play in the productivity gradient along the coast, as described by Hickey and Banas (2003).

Phosphate (PO_4) is essential for phytoplankton growth, playing a key role in cellular function and energy conversion (Perry et al. 1989). Surface waters and deepwaters of the Northern Study Area are replete with phosphate year-round, with nitrate-to-phosphate ratios that ensure that nitrogen species will be depleted by phytoplankton growth before phosphate is used up (Perry et al. 1989).

Dissolved silica is an essential macronutrient used by diatoms, the dominant phytoplankton species in the region in the Northern Study Area, to construct their frustules or shells (Hood et al. 1992). Water column studies have not been able to measure significant depletion of dissolved silica in the region, indicating that silicate is not a limiting nutrient for primary production (Lynn et al. 1998). Observations during the RISE program indicate that the water column north and south of the Columbia River has sufficient silicate (Bruland et al. 2008).

3.1.2.2.2 Dissolved Oxygen

Dissolved oxygen in seawater is derived from two sources: gas exchange with the atmosphere when the water mass is at the surface, and the in-situ balance between generation of oxygen from autotrophs during the day and consumption of oxygen through respiration by heterotrophs (day and night) and autotrophs (during the night). Dissolved oxygen levels are controlled by physical and biological processes; however, patterns of dissolved oxygen in the Northern Study Area generally follow those of the conservative physical parameters like temperature and salinity and density (Perry et al. 1989). The oxygen budget for the shelf area shows a high degree of seasonality, as well as temporal differences from north to south and across the shelf, following physical transport mechanisms, as shown in [Figure 3.4](#) (Hales et al. 2006).

Budget Term	Estimation Method	Value, mmol m ⁻³ d ⁻¹	Uncertainty, mmol m ⁻³ d ⁻¹	Uncertainty Estimation Method
Temporal change	difference between 5/28 and 8/12 cross-shelf integrated O ₂ at CP divided by 75 days	-0.61	±0.12	±3% uncertainty in May and August integrated O ₂
Air-sea exchange	cross-shelf integrated instantaneous gas exchange flux, using cubic dependence on TGT DAS wind speed	-0.64	-0.17 - +0.09	comparison of cross-shelf integrated flux estimated with various combinations of winds from NDBC 46050, 2nd-order dependence on wind, etc.
Cross-shelf transport	mean Ekman transport multiplied by difference between source and surface water concentrations	-0.66	±0.17	uncertainty in Ekman flow propagated by uncertainty in source and surface water O ₂ concentrations
Alongshore transport	difference between cross-shelf integrated O ₂ fluxes at CH and CP, divided by distance between CH and CP	-1.3	-2.3 - +1.3	extreme ranges in observed alongshore water transport max.
Consumption in sediments	<i>Hartnett and Devol</i> [2003]	-0.10	±0.10	100% uncertainty
Net production	temporal change minus sum of remaining terms	2.1	-1.3 - +2.3	propagation of above uncertainties

Figure 3.4. Table summarizing the discrete O₂ budget

Scanned from Hales et al. 2006.

The deepwaters of the Northern Study Area are generally low in dissolved oxygen, while it is high in surface waters, sometimes reaching supersaturation during phytoplankton blooms in spring and summer (Hales et al. 2006; Grantham et al. 2004). Within the study area, surface waters off the Washington coast are generally higher, reaching supersaturation levels up to 130 percent. Surface levels off the Oregon coast seldom exceed 100 percent, except off Hecata Bank in southern Oregon, where seasonal upwelling reaches a maximum and phytoplankton grow rapidly (Perry et al. 1989). Seasonal upwelling brings low-oxygen water to the surface, where it becomes reoxygenated. However, upwelled water from depths may reside below the surface and be advected north with prevailing subsurface currents, which carry low-oxygen water as far as northern Washington and into Puget Sound (Warner et al. 2001).

Recent observations have revealed the presence of a bottom anoxic zone occurring in the midshelf region of Oregon and southern Washington, developing late in the upwelling season ([Figure 3.5](#)).

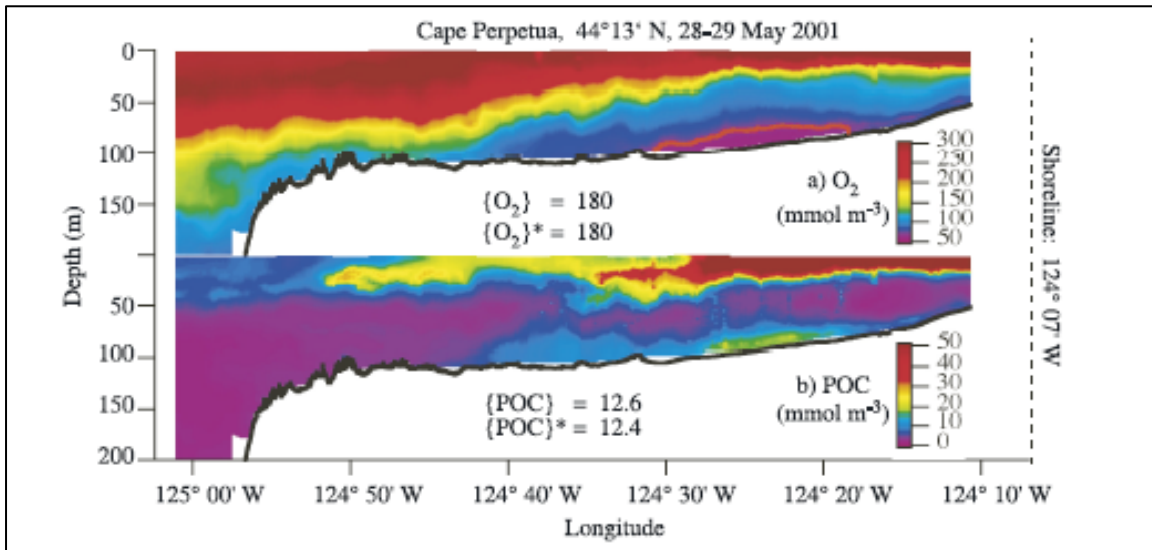

Figure 3.5. Cross-shelf distributions of calibrated (a) O_2 and (b) particulate organic carbon (POC) concentrations for the section off Cape Perpetua, Oregon, on 28-29 May 2001, showing contoured data.

The bracketed values for O_2 and POC are the average of all the data contained between the longitudes of the 50- and 180-m isobaths, and the second value (indicated by the asterisk) is the average of all data contained between the longitudes of the 35- and 200-m isobaths. The location of the coast is indicated by the vertical dashed line on the right.

Source: Hales et al. (2006)

During strong upwelling, most of the phytoplankton blooms are swept off the shelf and into deepwater. However, in recent years, reduced Ekman flow has lessened upwelling by midsummer, resulting in phytoplankton-laden waters remaining over the shelf (Grantham et al. 2004). As the phytoplankton sink and decay, bacterial respiration can reduce dissolved oxygen levels at depth, resulting in hypoxic conditions over the midshelf that can smother benthic organisms and resident fish (Hales et al. 2006; Grantham et al. 2004).

3.1.2.2.3 Particulate Material

Particulate material has three major sources: riverine discharge, resuspension of bottom material, and growth and excretion from surface activity through the food chain. Leithold and Hope (1999) investigated the accumulation and subsequent dispersal of particulate material on the shelf from flood discharge from the Eel River in California and found that following such deposition, bioturbation and resuspension by waves and currents were important processes for the dispersion of particulate material from the deposition site.

Hales et al. (2006) described a simple model relating the changes in particulate material distribution to the upwelling regime. During upwelling conditions, the high phytoplankton growth at the surface develops organic particles that are carried off into deepwater by the offshore flow. The bottom benthic layer is stirred up by the turbulent benthic boundary layer and some of that material supplies nutrients that contribute to the high productivity observed ([see Section 3.1.2.2.1. on Nutrients](#)). During relaxation conditions, the surface productivity is much

reduced and contained inshore, where particulate material is deposited in shallow water (Figure 3.6). During relaxation, the benthic boundary layer moves any suspended particulate matter offshore and into deepwater.

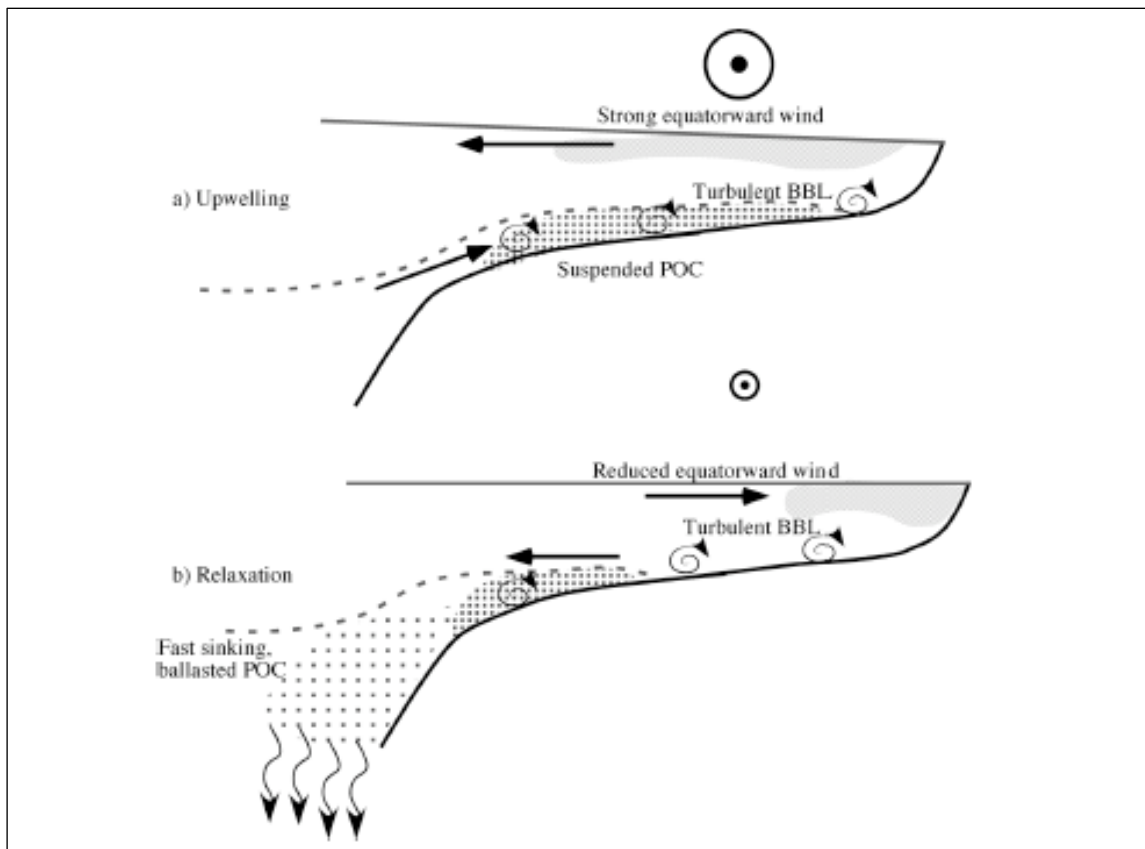

Figure 3.6. Schematic representation of simplified (a) upwelling and (b) relaxation conditions. Small near-surface dots represent newly photosynthetically produced POC; larger near-bottom dots represent flocculated, ballasted POC.

Source: Hales et al. (2005a).

3.1.2.2.4 Trace Metals

The Oceanographic Institute of Washington (1977) synthesis provides details and reference lists of trace metals, including mercury, copper, lead, and zinc, entering the marine environment from rivers and streams in the Northern Study Area. The metals purveyed by rivers and streams into the marine environment originate in earth crustal materials and wastewater discharged inland. Little research has been conducted on the sources of trace metals since 1977. There are few direct emissions of industrial material directly into the marine environment because much of the coastline of the Northern Study Area is relatively unpopulated. The distribution and fate of key trace metals is described later in this chapter. [Chapter 17.2 of](#) this volume discusses impacts to the marine environment from release of trace metals from antifouling paint (copper) and sacrificial anodes (zinc).

3.1.2.2.5 Sulfur Compounds

Sulfur-containing compounds are abundant in seawater; most remain in the fully oxidized form, but a variety of reduced sulfur species are also formed. These include organosulfur compounds associated with organisms, including the amino acid cysteine, dimethyl sulfoxide, and related compounds photochemically cycled in the surface waters, as well as chemically reduced forms of sulfur such as elemental sulfur, polysulfides, and hydrogen bisulfide cycled by microbes in the sediments and at the sea floor. Numerous studies have considered the distribution of reduced sulfur species in sediments (Berelson et al. 2005; McManus et al. 2006), as well as the biological oxidation of reduced sulfur in mat systems (Kalanetra et al. 2004). However, few studies have considered large-scale releases of reduced sulfur in the Northern Study Area. There is reason to consider the fate of sulfide in the study area, as a major upwelling area off the coast of Namibia seemingly hosts massive sulfide eruptions that impact water quality and are visible from space (Weeks et al. 2004). It is not known whether similar processes could occur in the study area under scenarios of changing ocean currents and temperatures, though it is well established that the intermediate waters in the study area are perennially oxygen-depleted (Helly and Levin 2004).

3.2 WATER COLUMN PROCESSES—NATURAL SYSTEM DYNAMICS

Many biogeochemical processes affect the vertical distribution of chemicals in the ocean. The predominant processes in the Northern Study Area that alter the chemical distributions within the water column and the geochemistry occurring at the sediment-water interface are physical processes (e.g., upwelling, stratification), biological processes (e.g., primary production and respiration), and chemical processes (e.g., scavenging by settling particles, oxidation-reduction-driven phase changes). Nozaki (1997) illustrated the Pacific Ocean water column profiles with the elements arranged as in the periodic table, showing which elements are involved in biological processes with lower concentrations in surface waters (except oxygen and other noble gases). Elements such as lead (Pb) are found at higher concentrations at the surface due to atmospheric deposition and then decrease due to scavenging processes at depth. This present chapter addresses the current available research on how these processes alter the water-column chemistry within the Northern Study Area. The settling of suspended particulates is discussed in [Chapter 2, Geological Oceanography](#).

3.3 DISTRIBUTION AND FATE OF CHEMICAL CONSTITUENTS

Chemical constituents are distributed throughout the water column, in surface sediments, and buried in deeper sediments through processes of incorporation into living cells, diagenesis, mixing, and dilution. Many organic and inorganic compounds can react to form new chemicals or can be scavenged and buried in sediments. This section will examine the distribution and fate of organic matter, including the interaction of organic matter with inorganic substances, and the fate of trace metals.

3.3.1 Organic Matter

Particulate and dissolved organic matter in the water column and surface sediments of the Northern Study Area is derived largely from natural sources within the water column, or imported from the rivers and streams that cross the continental shelf, with smaller inputs from

the open ocean and atmosphere (Perry et al. 1989). The coastline of the Northern Study Area is relatively unpopulated and most anthropogenic sources are filtered out in the watershed or the very nearshore ocean.

Organic matter production (POM and DOM) is closely tied to nutrient cycles and other oceanographic parameters (Landry et al. 1989). Seasonal patterns of macronutrients on the continental shelf are directly linked to patterns of upwelling, particularly along the Washington and Oregon coasts, and are also controlled by primary productivity of phytoplankton and secondary productivity of zooplankton (Landry and Hickey 1989; Huyer et al. 2007). On an annual basis, salty, nutrient-rich water flows onshore at depth when downwelling winds relax and weak upwelling begins in early summer. The summertime inflow of saline water onto the inner shelf is one means by which the slope and basin communicate directly with the inner shelf (Goes et al. 2001). Wind-driven upwelling of nutrients from deeper layers fuels autochthonous organic matter production, resulting in fluctuations on time scales of days. The generalized spatial distribution of autochthonous organic matter includes production at upwelling areas, movement of algal blooms offshore, depleting the offshore nutrient supply, and reversals occurring as storm events move blooms back toward shore (Roegner et al. 2002). Modeling studies show that buoyant plumes associated with a point discharge (such as the Columbia River plume) respond differently to upwelling winds than do those formed by distributed discharges from multiple coastal rivers (Goes et al. 2001). As mentioned earlier, the Columbia River plume shifts seasonally and with the wind (Landry et al. 1989; Hickey et al. 2005, 2008). The plume chemistry varies seasonally and with oceanographic conditions, tidal phase and river flow (Nash et al. 2009; Bruland et al. 2008). Features such as the offshore eddies provide an effective mechanism for trapping particles such as suspended sediment or organic detritus and further fueling primary production (Huyer et al. 2007). The associated high carbon and nitrogen rain rate through the shallow water column of the shelf combined with riverine contribution of terrestrial material is responsible for a relatively high organic input to shelf and slope sediments. Continental margin sediments are therefore important sites for oceanic biogeochemical cycling of carbon and nitrogen.

Recent studies—including several oceanographic programs such as GLOBEC (GLOBal Ocean ECosystems Dynamics North East Pacific) program (<http://www.globec.org>) and the Coastal Ocean Processes sponsored Coastal Ocean Advances in Shelf Transport program (<http://damp.oce.orst.edu/coast>)—provide data on the water column distribution of macronutrients within the Northern Study Area and highlight the link between upwelling conditions and water column chemistry (Hales et al. 2005b; 2006; Huyer et al. 2007; Van Geen et al. 2000; Hickey et al. 2002; Chavez et al. 2002). Macronutrient concentrations (nitrate, phosphate, and silicate) of upwelling-source waters vary inversely with halocline temperature, as shown in spatial and temporal patterns of the water column off the Oregon coast (Huyer et al. 2007). However, the availability of micronutrients may influence the assimilation ratios of nitrate, and to a lesser extent silicate, by diatoms, hence altering their oceanic distribution (Fitzwater et al. 2000; Franck et al. 2000) and potentially the diatom assemblages.

Southward currents bring cool, nitrate-rich waters in summer (especially during large-scale climatic shifts such as the Subarctic Invasion) and northward currents bring relatively warm,

nitrate-poor waters in winter, especially during ENSO (Huyer et al. 2007 and references therein). Even though winter plankton biomass may be nutrient-poor and declining rather than growing, it may provide a direct food source for secondary production, particularly near the mouths of estuaries (Landry and Hickey 1989). Influences from the ocean may change water properties in coastal and estuarine water bodies significantly over just a few tidal cycles, affecting the production of organic matter throughout the water column (Hickey and Banas 2003).

Nitrate concentrations in upwelled waters off Oregon can be rapidly depleted by photosynthesis with no reported micronutrient limitations, which is consistent with the upwelling path through the benthic boundary layer (BBL) containing exceptionally high dissolved iron (Hales et al. 2005b and references therein). This prolific primary production consumes carbon dioxide (CO₂) in stoichiometric proportion to the total available nitrate, with standing stocks of chlorophyll and particulate organic carbon (POC) reaching concentrations in excess of 20 mg/kg and 100 mmol/kg, respectively (see Hales et al. 2005 and 2006 and references therein). This process drives the Oregon coastal surface water CO₂ concentration far below atmospheric saturation and has been hypothesized as a mechanism resulting in carbon removal from the coastal ocean and sequestration by removal to the deep ocean (Chen et al. 2004; Hales et al. 2005b and 2006). In this region, the rain of POC from the surface enters bottom waters that are low in dissolved oxygen, further depleting the dissolved oxygen during respiration. The vertical profiles for dissolved oxygen resulting from these processes record supersaturated surface waters decreasing to less than 60 mmol/m³ in near-bottom waters (below most canonical definitions of hypoxia) (Hales et al. 2006 and references therein). Hales et al. (2006) quantified the season-long, net production rate of dissolved oxygen and POC and concluded that nearly all of the net production of organic carbon appears to be exported from the shelf to the adjacent deep ocean during respiration of organic matter. This suggests a mechanism whereby the duration and frequency of upwelling events and relaxations can determine the extent to which new carbon produced by photosynthesis in the coastal ocean is exported to deepwaters rather than being respired on the shelf (Hales et al. 2006). Hales et al. (2006) further speculated that an interruption of this export mechanism may lead either to unrealistic standing stocks of POC or to widespread anoxic near-bottom waters. However, Chen et al. (2004) concluded that the coastal ocean absorbs CO₂ at an average rate of 1.1 ± 0.3 mol C/m²/yr, but it releases nitrogen and nitrogen dioxide at an average rate of 0.07 ± 0.03 mol N/m²/yr and most of the organic matter is regenerated on the shelf, with less than 15 percent transported to the open ocean as dissolved and particulate organic carbon.

3.3.2 Composition of Organic Matter

During the last few decades, a number of studies have investigated the relationship between water depth, benthic metabolism, and nutrient regeneration to evaluate the preservation of organic matter (Keil et al. 2004; Kristensen et al. 1999 and references therein). In general, benthic metabolism appears to be directly related to surface water productivity and oxygen exposure time (Keil et al. 2004), but inversely related to water depth (Kristensen et al. 1999). In fact, the total carbon and nitrogen mineralization in sediments off Washington was reduced 70 to 80 percent in water depth from 100 to 200 m compared with that at 1,000 m (Kristensen et al. 1999). McKee et al. (2004) summarizes the state of knowledge on the important transport and transformation of dissolved and particulate matter on continental margins influenced by major

rivers, highlighting the critical sedimentary processes that support organic matter composition, storage, and carbon removal.

The carbonate compensation depth (CCD), the depth below which preservation of calcium carbonate in surface sediments is negligible, is generally very deep in the Atlantic Ocean (up to 6,000 m); however in the Pacific, it may be as shallow as 3,500 m (Thurman 1994). The shallower Pacific CCD brings lower-pH water closer to the productive surface layers of the ocean. Recent investigations have shown that this lens of low-pH water is closer to the surface than oceanographers have hypothesized, having reached onto the Washington/Oregon shelf in the summer of 2007, due to coastal upwelling (Feely et al. 2008). Ocean acidification resulting from the long-term continuous absorption of CO₂ from atmospheric inputs has the potential to alter basic water chemistry, food webs, and the mix of marine organisms including fish, marine mammals, and birds throughout the Northern Study Area (Feely et al. 2008).

3.3.3 Trace Metals

Recent studies of trace metals within the Northern Study Area have focused primarily on understanding the cycling and role of micronutrients (primarily iron) as a limiting factor for primary production. The geochemical distribution and availability of iron play a critical role in supporting the high primary production in coastal upwelling regimes (Bruland et al. 2001; Lohan and Bruland 2008; Fitzwater et al. 2003; Buck et al. 2007; Chase et al. 2002; Chase et al. 2005; Chase et al. 2007). Iron sources to coastal systems are primarily derived from the remobilization and resuspension of marine sediments, aeolian deposition of dust, and riverine inputs (Fitzwater et al. 2003 and references therein). Dust deposition is relatively minor due to the prevalence of northwest winds, but riverine inputs are significant during episodic winter flood events off California (Bruland et al. 2001) and continuous from the Columbia River plume (Buck et al. 2007). Riverine inputs create a gradient of iron concentrations in surface water from the coast offshore, with dissolved iron concentrations in coastal waters orders of magnitude greater than those in open ocean environments (Bruland et al. 2001).

The width of the continental shelf in the Northern Study Area influences the supply of iron in the Northern Study Area; the shelf is narrow compared to that of the Atlantic coastline, but constitutes a significant area from which iron and other chemicals of importance are derived. Upwelling off Oregon and Washington results in subsurface water being depleted in dissolved oxygen over the mid and inner shelf as water low in dissolved oxygen from the outer shelf/slope region moves shoreward along the BBL. Additional respiration, fueled by overlying productive waters, further decreases dissolved oxygen and creates the hypoxic conditions observed in the subsurface shelf waters off Oregon and Washington. The low dissolved oxygen drives the reductive dissolution of iron in porewater close to the sediment water interface, leading to an increased flux of labile iron (FeII) from the sediment, while the low oxygen, pH, and temperatures within the BBL collectively slow down the oxidation rate of the iron (II) (Lohan and Bruland 2008). These processes provide additional, highly labile, iron to the surface and further support high rates of primary production during upwelling conditions.

Buck et al. (2007) evaluated the chemical speciation of iron in the Columbia River plume, the San Francisco Bay plume, and the Columbia River estuary. In the Columbia River plume, the

leachable particulate iron is much higher than that in the San Francisco Bay plume, likely because of the distinctly different hydrologic characteristics of the rivers (Buck et al. 2007). The distribution of dissolved iron was primarily a function of the ligand chemistry in both plumes regardless of the amount of leachable dissolved iron released from the suspended particles (Buck et al. 2007).

Bruland et al. (2001) compared dissolved and particulate iron concentrations along the California coast in areas where the shelf is wide and where the shelf is narrow. Where the shelf is wide, the concentrations of dissolved and particulate iron were high (> 10 nmol) and primary production was prolific. In areas where the shelf was narrow, the concentrations of dissolved and particulate iron are low (< 1 nmol) and primary productivity is limited. The riverine supply of less labile, particulate iron that is deposited on the shelf may become an indirect riverine supply of *more* labile, dissolved iron through remineralization processes occurring on the coastal shelf followed by upwelling of these waters to the surface (Buck et al. 2007; Elrod et al. 2004). Therefore the water column profiles for production of iron and subsequently phytoplankton are primarily a function of particulate resuspension at the sediment-water interface over the shelf. Elevated particulate iron concentrations in surface waters result from the resuspended sediments in the BBL of the shallow shelf being transported to the surface during upwelling. The supply of resuspended sediment is only part of the equation, as the iron must also be in a labile form available for uptake by phytoplankton.

3.4 SUMMARY AND DATA GAPS

Over the last several centuries the release of CO₂ from industrial and agricultural activities has steadily increased the CO₂ concentrations in the atmosphere. The unique chemistry of the ocean (carbonate buffering system) allows it to absorb billions of tons of carbon as CO₂ from the atmosphere. Through this buffering cycle, the pH of the ocean was previously thought to be relatively uniform globally. The pace of current literature findings on this topic is rapid, but only Feely et al. (2008) have published evidence of the upwelling of oceanic water with a lower pH than global averages. In the coming decades, this phenomenon, called “ocean acidification,” could affect some of the most fundamental biological and geochemical processes of the sea and seriously alter the fundamental structure of pelagic and benthic ecosystems. Further research is needed on the relationship between changes in atmospheric chemistry, oceanic pH levels, coastal upwelling, and biogeochemical processes within the Northern Study Area.

There is a need to better understand the relationship between coastal organic matter cycles, development of hypoxia, and large-scale climate drivers (Pacific Decadal Oscillation (PDO) and El Niño Southern Oscillation (ENSO)) within the Northern Study Area. Huyer et al. (2007) demonstrated the link between the subarctic invasion and water column chemistry off the coast of Oregon. Chavez et al. (2002) summarized the physical, chemical, and biological perturbations in central California waters associated with the strong 1997–1998 ENSO and concluded that the strength and direction of the ecosystem’s response appeared to be related to the longer term background climatic state of the Pacific Ocean. The ecological effects during this ENSO were weaker than those documented during the 1982–1983 and 1992–1993 ENSOs, which Chavez et al. (2002) linked to a shift in the sign of the Pacific Decadal Oscillation during the ENSO. Data gathering is also needed to determine the response of marine micro-organisms to the riverine

nutrient and carbon supplies on a broader timescale to determine the influence that ENSO/La Niña cycles and other atmospheric fluctuations might have on winter precipitation, productivity, and ultimately, the riverine inputs and ecosystem response.

The relationship between ocean climate change, upwelling-driven hypoxia, and ecological perturbations is critical. Grantham et al. (2004) reported the unprecedented development of severe inner-shelf (less than 70 m) hypoxia during an anomalously strong flow of subarctic water into the California Current System. The resultant mass fish and invertebrate kills highlight the need to further understand these linkages. In addition, information is needed on the role that iron sources from shelf sediment have on fueling primary productivity, which further perturbs existing low-dissolved-oxygen conditions off the coast. The impacts of alterations in sedimentary transport from the shelf into the estuary resulting from energy consumption from the system, stratification and dissolved oxygen distributions, and sources/sinks of micronutrients such as iron (from alternative energy structures), are critical knowledge gaps for the Northern Study Area.

3.5 LIST OF LITERATURE CITED—CHEMICAL OCEANOGRAPHY

- Aguilar-Islas, A.M. and K.W. Bruland. 2006. Dissolved manganese and silicic acid in the Columbia River plume: A major source to the California current and coastal waters off Washington and Oregon. *Chemistry* 101(3-4):233-247.
- Banas, N.S., P. MacCready and B.M. Hickey. 2009. The Columbia River plume as cross-shelf exporter and along-coast barrier. *Continental Shelf Research* 29(1):292-301.
- Barnes, C.A., A.C. Duxbury and B.A. Morse. 1972. Circulation and selected properties of the Columbia River effluent at sea In: D.L. Alverson and A.L. Pruter. *Bioenvironmental Studies of the Columbia River Estuary and Adjacent Ocean Regions*. Seattle, Washington: University of Washington Press. Pp 41–80.
- Barth, J.A., S.D. Pierce and T.J. Cowles. 2005. Mesoscale structure and its seasonal evolution in the Northern California Current System. *Deep-Sea Research Part II Topical Studies in Oceanography* 52(1-2):5-28.
- Berelson, W.M., M. Prokopenko, F.J. Sansone, A.W. Graham, J. McManus and J.M. Bernhard. 2005. Anaerobic diagenesis of silica and carbon in continental margin sediments: Discrete zones of TCO₂ production. *Geochimica et Cosmochimica Acta* 69(19):4611-4629.
- Berger, C.J.M., S.M. Lippitt, M.G. Lawrence and K.W. Bruland. 2008. Application of a chemical leach technique for estimating labile particulate aluminum, iron, and manganese in the Columbia River plume and coastal waters off Oregon and Washington. *Journal of Geophysical Research-Oceans* 113.
- Bronk, D.A., J.H. See, P. Bradley and L. Killberg. 2007. DON as a source of bioavailable nitrogen for phytoplankton. *Biogeosciences* 4(3):283-296.

- Bruland, K.W., E.L. Rue and G.J. Smith. 2001. Iron and macronutrients in California coastal upwelling regimes: Implications for diatom blooms. *Limnology and Oceanography* 46(7):1661-1674.
- Bruland, K. W., M. C. Lohan, A. M. Aguilar-Islas, G. J. Smith, B. Sohst and A. Baptista. 2008. Factors influencing the chemistry and formation of the Columbia River plume: Nitrate, silicic acid, dissolved Fe and dissolved Mn, *Journal of Geophysical Research*, 113, C00B02, doi:10.1029/2007JC004702.
- Buck, K.N., M.C. Lohan, C.J.M. Berger and K.W. Bruland. 2007. Dissolved iron speciation in two distinct river plumes and an estuary: Implications for riverine iron supply. *Limnology and Oceanography* 52(2):843-855.
- Chase, Z., B. Hales, T.J. Cowles, R. Schwartz and A. van Geen. 2005. Distribution and variability of iron input to Oregon coastal waters during the upwelling season. *Journal of Geophysical Research*, 110, C10S12, doi:10.1029/2004JC002590.
- Chase, Z., P. G. Strutton and B. Hales. 2007. Iron links river runoff and shelf width to phytoplankton biomass along the U.S. West Coast. *Geophys. Res. Lett.*, 34, L04607, doi:10.1029/2006GL028069.
- Chase, Z., A. Van Geen, P.M. Kosro, J. Marra and P.A. Wheeler. 2002. Iron, nutrient, and phytoplankton distributions in Oregon coastal waters. *Journal of Geophysical Research-Oceans* 107(C10).
- Chavez, F.P, J.T. Pennington, C.G. Castro, J.P. Ryan, R.P. Michisaki, B. Schlining, P. Walz, K.R. Buck, A. Mcfadyen and C.A. Collins. 2002. Biological and chemical consequences of the 1997–1998 El Niño in central California waters. *Progress in Oceanography* 54:205-232.
- Chen, C.T.A., A. Andreev, K.R. Kim and M. Yamamoto. 2004. Roles of continental shelves and marginal seas in the biogeochemical cycles of the North Pacific Ocean. *Journal of Oceanography* 60:17-44.
- Conomos, T.J., M.G. Gross, C.A. Barnes and F. A. Richards. 1972. River-ocean nutrient relations in summer. In: A.T. Pruter and D.L. Alverson. *The Columbia River Estuary and Adjacent Ocean Waters*. Seattle, WA: University of Washington Press. Pp 151–175.
- Elrod, V.A., W.M. Berelson, K.H. Coale and K.S. Johnson. 2004. The flux of iron from continental shelf sediments: A missing source for global budgets. *Geophysical Research Letters* 31(12).
- Feely, R.A., C.L. Sabine, J.M. Hernandez-Ayon, D. Ianson and B. Hales. 2008. Evidence for upwelling of corrosive “acidified” water onto the continental shelf. *Science* 320(5882):1490-1492.
- Firme, G.F., E.L. Rue, D.A. Weeks, K.W. Bruland and D.A. Hutchins. 2003. Spatial and temporal variability in phytoplankton iron limitation along the California coast and

- consequences for Si, N and C biogeochemistry. *Global Biogeochemical Cycles*, 17(1), 1016, doi:10.1029/2001GB001824.
- Fitzwater, S.E., K.S. Johnson, V.A. Elrod, J.P. Ryan, L.J. Coletti, S.J. Tanner, R.M. Gordon and F.P. Chavez. 2003. Iron, nutrient and phytoplankton biomass relationships in upwelled waters of the California coastal system. *Continental Shelf Research* 23(16):1523-1544.
- Fitzwater, S.E., K.S. Johnson, R.M. Gordon, K.H. Coale and W.O. Smith. 2000. Trace metal concentrations in the Ross Sea and their relationship with nutrients and phytoplankton growth. *Deep Sea Research, Part II* 47:3159-3179.
- Frame, E.R., and E.J. Lessard. 2009. Does the Columbia River plume influence phytoplankton community structure along the Washington and Oregon coasts? *Journal of Geophysical Research*, 114, C00B09, doi:10.1029/2008JC004999.
- Franck, V.M., M.A. Brezezinski, K.H. Coale and D.M. Nelson. 2000. Iron and silicic acid availability regulate Si uptake in the Pacific sector of the Southern Ocean. *Deep Sea Research, Part II* 47:3315-3338.
- Goes, J. I., H. do R. Gomesa, A. Limsakulb, W. M. Balcha and T. Saino. 2001. El Niño related interannual variations in biological production in the North Pacific as evidenced by satellite and ship data. *Progress in Oceanography*. 49(1-4):211-225.
- Grantham, B.A., F. Chan, K.J. Nielsen, D.S. Fox, J. A. Barth, A. Huyer, J. Lubchenco and B. A. Menge. 2004. Upwelling-driven nearshore hypoxia signals ecosystem and oceanographic changes in the northeast Pacific. *Nature* 429(6993):749-754.
- Hales, B., L. Karp-Boss, A. Perlin and P.A. Wheeler. 2006. Oxygen production and carbon sequestration in an upwelling coastal margin. *Global Biogeochemical Cycles* 20(3).
- Hales, B., J.N. Moum, P. Covert and A. Perlin. 2005a. Irreversible nitrate fluxes due to turbulent mixing in a coastal upwelling system. *Journal of Geophysical Research*, 110, C10S11, doi:10.1029/2004JC002685.
- Hales, B., T. Takahashi and L. Bandstra. 2005b. Atmospheric CO₂ uptake by a coastal upwelling system. *Global Biogeochemical Cycles* 19(1).
- Helly, J.J. and L.A. Levin. 2004. Global distribution of naturally occurring marine hypoxia on continental margins. *Deep-Sea Research Part I-Oceanographic Research Papers* 51(9):1159-1168.
- Hickey, B.M. and N.S. Banas. 2003. Oceanography of the U.S. Pacific Northwest Coastal Ocean and estuaries with application to coastal ecology. *Estuaries* 26(4B):1010-1031.
- Hickey, B.M. and N.S. Banas. 2008. Why is the Northern End of the California Current System So Productive? *Oceanography* 21(4):90-107.

- Hickey, B., S. Geier, N. Kachel and A. MacFadyen. 2005. A bi-directional river plume: The Columbia in summer. *Continental Shelf Research*, 25, 1631–1656, doi:10.1016/j.csr.2005.04.010.
- Hickey, B.M., R.M. Kudela, J.D. Nash, K.W. Bruland, W.T. Peterson, P. MacCready, E.J. Lessard, D.A. Jay, N.S. Banas, A.M. Baptista, E.P. Dever, P.M. Kosro, L.K. Kilcher, A.R. Horner-Devine, E.D. Zaron, R.M. McCabe, J.O. Peterson, P.M. Orton, J. Pan and M.C. Lohan. 2010. River Influences on Shelf Ecosystems: Introduction and synthesis. *Journal of Geophysical Research* 115, C00B17, doi:10.1029/2009JC005452.
- Hickey, B., R. McCabe, S. Geier, E. Dever and N. Kachel. 2008. Three interacting freshwater plumes in the Northern California Current System. *Journal of Geophysical Research*, doi:10.1029/2008JC004907
- Hickey, B.M., M. Zhang and N. Banas. 2002. Coupling between the California Current System and a coastal plain estuary in low riverflow conditions. *Journal of Geophysical Research* 107(C10):3166.
- Hood, R. R., S. Neuer, et al. 1992. Autotrophic production, biomass and species composition at 2 stations across an upwelling front. *Marine Ecology-Progress Series* 83(2-3):221-232.
- Hutchins, D.A. and K.W. Bruland. 1998. Iron-limited diatom growth and Si:N uptake ratios in a coastal upwelling regime. *Nature* 393:561-564.
- Hutchins, D.A., G.R. DiTullio, Y. Zhang and K.W. Bruland. 1998. An iron limitation mosaic in the California upwelling regime. *Limnology and Oceanography*, 43:1037-1054.
- Huyer, A., P.A. Wheeler, P.T. Strub, R.L. Smith, R. Letelier and P.M. Kosro. 2007. The Newport line off Oregon-Studies in the North East Pacific. *Progress in Oceanography* 75(2):126-160.
- Kalanetra, K.M., S.L. Huston and D.C. Nelson. 2004. Novel, attached, sulfur-oxidizing bacteria at shallow hydrothermal vents possess vacuoles not involved in respiratory nitrate accumulation. *Applied and Environmental Microbiology* 70(12):7487-7496.
- Keil, R.G., A.F. Dickens, T. Arnarson, B.L. Nunn and A.H. Devol. 2004. What is the oxygen exposure time of laterally transported organic matter along the Washington margin? *Marine Chemistry* 92(1-4):157-165.
- Kimbrough, K. L., W. E. Johnson, G. G. Lauenstein, J. D. Christensen and D. A. Apeti. 2008a. An Assessment of Two Decades of Contaminant Monitoring in the Nation's Coastal Zone. Silver Spring, MD. NOAA Technical Memorandum NOS NCCOS 74. 105 pp
- Kimbrough, K. L., W. E. Johnson, G. G. Lauenstein, J. D. Christensen and D. A. Apeti. 2008b. An Assessment of Polybrominated Diphenyl Ethers (PBDEs) in Sediments and Bivalves of the U.S. Coastal Zone. Silver Spring, MD. NOAA Technical Memorandum NOS NCCOS 78 76 pp.

- Kristensen, E., A.H. Devol and H.E. Hartnett. 1999. Organic matter diagenesis in sediments on the continental shelf and slope of the Eastern Tropical and temperate North Pacific. *Continental Shelf Research* 19(10):1331-1351.
- Kudela, R. M. and T. D. Peterson. 2009. Influence of a buoyant river plume on phytoplankton nutrient dynamics: What controls standing stocks and productivity? *Journal of Geophysical Research*, 114, C00B11, doi:10.1029/2008JC004913.
- Landry, M.R and B.M. Hickey. 1989. *Coastal Oceanography of Washington and Oregon*. Amsterdam, Netherlands: Elsevier Press.
- Landry, M.R., J.R. Postel, W.K. Peterson and J. Newman. 1989. Broad-Scale Distributional Patterns of Hydrographic Variables on the Washington/Oregon Shelf. *Coastal Oceanography of Washington and Oregon*. Elsevier.
- Leithold, E.L. and R.S. Hope. 1999. Deposition and modification of a flood layer on the Northern California Shelf: lessons from and about the fate of terrestrial particulate organic carbon. *Marine Geology* 154(1-4):183-195.
- Lohan, M.C. and K.W. Bruland. 2006. Importance of vertical mixing for additional sources of nitrate and iron to surface waters of the Columbia River plume: Implications for biology. *Marine Chemistry* 98(2-4):260-273.
- Lohan, M. C. and K. W. Bruland. 2008. Elevated Fe(II) and dissolved Fe in hypoxic shelf waters off Oregon and Washington: An enhanced source of iron to coastal upwelling regimes. *Environmental Science & Technology* 42(17):6462-6468.
- Lynn, R. , T. Baumgartner, J. Garcia, C.A. Collins, T. Hayward, K. Hyrenbach, A.W. Mantyla, T. Murphree, A. Shankle, F. Schwing, K. Sakuma and M. Tegner. 1998. The state of the California current, 1997-1998: Transition to El Niño conditions. *California Cooperative Oceanic Fisheries Investigations Reports* 39:25-49.
- McKee, B.A., R.C. Aller, M.A. Allison, T.S. Bianchi and G.C. Kineke. 2004. Transport and transformation of dissolved and particulate materials on continental margins influenced by major rivers: Benthic boundary layer and seabed processes. *Continental Shelf Research* 24(7-8):899-926.
- McManus, J., W.M. Berelson, S. Severmann, R.L. Poulson, D.E. Hammond, G.P. Klinkhammer and C. Holm. 2006. Molybdenum and uranium geochemistry in continental margin sediments: Paleoproxy potential. *Geochimica et Cosmochimica Acta* 70(18):4643-4662.
- Nash, J.D., L.F. Kilcher and J.N. Moum. 2009. Structure and composition of a strongly stratified, tidally pulsed river plume. *Journal of Geophysical Research* 114, C00B12, doi:10.1029/2008JC005036
- Nittrouer, C.A. 1978. *The process of detrital sediment accumulation in a continental shelf environment: An examination of the Washington Shelf*. University of Washington. 244 pp.

- Nozaki, Y. 1997. A fresh look at element distribution in the North Pacific Ocean. EOS Trans. AGU 78 221.
- Oceanographic Institute of Washington, and Human Resources Planning Institute. 1977. A summary of knowledge of the Oregon and Washington coastal zone and offshore areas. Springfield, VA: U.S. Dept. of Commerce .National Technical Information Service.
- Parsons, T.R., M. Takahashi, et al. 1984. Biological Oceanographic Processes. Oxford, Pergamon Press.
- Pearcy, W.G. 1992. Ocean Ecology of North Pacific Salmonids 1992. Seattle, Washington.
- Prahl, F.G., J.R. Ertel, M.A. Goni, M.A. Sparrow, and B. Eversmeyer. 1994. Terrestrial organic carbon contributions to sediments on the Washington margin. Geochim et Cosmochimica Acta, 58:3035-3048.
- Perry, M.J., J.P. Bolger and D.C. English. 1989. Primary production in Washington Coastal Waters. In: M.R. Landry and B.M.Hickey. Coastal Oceanography of Washington and Oregon. Amsterdam: Elsevier. 117-173.
- Roegner, G. C., B. M. Hickey, J. A. Newton, A. L. Shanks and D. A. Armstrong. 2002. Estuarine-nearshore links during a coastal upwelling-downwelling cycle: Plume and bloom intrusions into Willapa Bay, Washington. Limnology and Oceanography 47 1033-1042.
- Sarmiento, J.L. and J. Gruber. 2006. Ocean Biogeochemical Dynamics. Princeton, NJ: Princeton University Press. 503.
- Sullivan, B.E., F.G. Prahl, L.F. Small and P.A. Covert. 2001. Seasonality of phytoplankton production in the Columbia River Estuary: A natural or anthropogenic pattern? Geochimica et Cosmochimica Acta, 65(7): 1125-1139.
- Thomas, A.C. and R.A. Weatherbee. 2006. Satellite-measured temporal variability of the Columbia River plume, Remote Sens. Environ., 100, 167– 178, doi:10.1016/j.rse.2005.10.018.
- Thurman, H.V. 1994. Introductory Oceanography. New York, Macmillan Publishing Company.
- Trainer, V.L., B.M. Hickey and R.A. Horner. 2002. Biological and physical dynamics of Domoic acid production off the Washington Coast. Limnol Ocean Vol. 47(5):1438-1446.
- Van Geen, A., R.K. Takesue, J. Goddard, T. Takahashi, J.A. Barth and R.L. Smith. 2000. Carbon and nutrient dynamics during coastal upwelling off Cape Blanco, Oregon. Deep Sea Research, Part II 47:975-1002.
- Volkman, J.K. and E. Tanoue. 2002. Chemical and biological studies of particulate organic matter in the ocean. Journal of Oceanography 58:265-279.

- Warner, M. J., M. Kawase and J. A. Newton. 2001. Proceedings of the 5th Puget Sound Research Conference. Seattle, WA. 1-9 pp.
- Weeks, S.J., B. Currie, A. Bakun and K. R. Peard. 2004. Hydrogen sulphide eruptions in the Atlantic Ocean off southern Africa: implications of a new view based on SeaWiFS satellite imagery. *Deep-Sea Research Part I-Oceanographic Research Papers* 51(2):153-172.
- Wetz, M.S., B. Hales, Z. Chase, P.A. Wheeler and M.M. Whitney. 2006. Riverine input of macronutrients, iron, and organic matter to the coastal ocean off Oregon, USA, during the winter. *Limnology and Oceanography* 51(5):2221-2231.
- Wetz, M.S., B. Hales and P.A. Wheeler. 2008. Degradation of phytoplankton-derived organic matter: Implications for carbon and nitrogen biogeochemistry in coastal ecosystems. *Estuarine Coastal and Shelf Science* 77(3):422-432.

4. PHYTOPLANKTON, ZOOPLANKTON, AND PELAGIC INVERTEBRATES

4.1 SPECIES COMPOSITION

Phytoplankton and zooplankton communities in the Northern Study Area are made up of a rich variety of species and genera that varies seasonally, interannually, and under certain meteorological conditions. Scientists rarely classify and count individual species of phytoplankton (plants), but do commonly enumerate zooplankton (animals) in the area to species and developmental stage; a large number of studies assess plankton species such as those that are targeted at potentially harmful or invasive species, species of interest as a food source for endangered fish, or examination of species changes under unusual oceanographic conditions (Keister and Peterson 2003; Mackas et al. 2007). With the advent of molecular techniques, bulk analysis of an array of photosynthetic pigments, and energetics modeling of the lower trophic levels of the marine food chain, assessments of species composition are being used infrequently as an analysis tool.

4.1.1 Phytoplankton Species Composition

Phytoplankton are categorized as those cells that contain chlorophyll for photosynthetic harvesting of sunlight; the line between phytoplankton, small microzooplankton and marine bacteria is often not clear; if cells contain chlorophyll they are generally considered to be plants, those without plant pigments are considered to be animals. Phytoplankton populations in the Northern Study Area are dominated by diatoms throughout most of the year, with periodic blooms of dinoflagellates and smaller green flagellates. Diatoms are single-celled photosynthetic organisms that form a silica shell around the cell. Each individual cell makes up an organism; however, many diatoms join together in long chains, although there is no communication or dependence among cells. Diatoms have no mechanisms for motility, slowing sinking through the water column, staying in the sunlit layers for photosynthesis due to turbulence in the upper layers. The most common diatom species in the Northern Study Area include chain-formers such as *Chaetoceros* spp., *Skeletonema* spp., and *Thalassiosira* spp., as well as solitary species such as *Coscinodiscus* spp.

Dinoflagellates are single celled plants that form a cellulose shell around each cell; each cell has two flagellae that are used in a whipping motion to locomote, allowing the cells to remain in the sunlit layer even when the water column is not turbulent. Several species of dinoflagellates including *Ceratium* sp. can reach dense blooms nearshore. Certain dinoflagellates release biotoxins into the water, creating a potentially hazardous situation for warm-blooded birds and mammals, including humans. These releases of biotoxins from actively blooming phytoplankton are commonly known as Harmful Algal Blooms (HABs). Like most phytoplankton blooms in the Northern Study Area, the HAB organism *Alexandrium catenella* occurs nearshore. However, episodic blooms of another HAB organism *Pseudo-nitzschia* sp., that were first seen in the early 1990s, originate offshore and are transported to the coast by wind and waves (Trainer et al. 2002).

Green flagellates and marine bacteria are small cells with soft cell walls. Marine bacteria are not motile and must be associated with particles or hard surfaces in the ocean. Both green flagellates and marine bacteria are often found in extremely high numbers during spring blooms and are present throughout the water column year round.

4.1.2 Zooplankton Species Composition

Zooplankton populations are composed of macrozooplankton and microzooplankton, and are often defined by an arbitrary size division (< 200 μm in diameter are microzooplankton; larger than this size are macrozooplankton). The zooplankton consists of holoplankton, or those organisms that spend their lives in the plankton, and meroplankton, those that spend a portion (most commonly larval stages) in the plankton, settling as late stage juveniles or adults on the ocean bottom or on shorelines and beaches. Many planktonic larvae fall into the macrozooplankton category while others are microzooplankton.

The macrozooplankton in the Northern Study Area is dominated by crustaceans, including many species of copepods, amphipods, euphausiids and decapods, as well as chaetognaths, molluskan and polychaete larvae, and many types of gelatinous organisms such as pelagic cnidarians (jelly fish) and ctenophores (comb jellies). The most commonly occurring copepods that make up the largest part of the macrozooplankton vary seasonally with a dominance of subarctic species such as *Pseudocalanus mimus*, *Calanus marshallae*, *Centropages abdominalis*, *Acartia longiremis*, and *Acartia hudsonica* during the summer, and warmer water species more common in winter including *Mesocalanus tenuicornis*, *Paracalanus parvus*, *Ctenocalanus vanus*, *Clausocalanus* spp., *Acartia tonsa* and *Corycaeus anglicus* (Keister and Peterson 2003). The Global Oceans Ecosystems Dynamics program (GLOBEC) sampled the shelf and offshore areas of Oregon and Northern California. The primary purpose of GLOBEC was to examine signals in the ocean due to climate change that might impact the food chain, with an emphasis on salmon. The program collected samples of zooplankton, krill, larval fish and pelagic fish (including juvenile salmon) along a few selected transects, from 1997-2004. Among other results, GLOBEC analyses showed changes in zooplankton species diversity and biomass from 1996 to 2004 ([Figure 4.1](#)) (GLOBEC 2009; Hooff and Peterson 2006) that were related to the sign of the Pacific Decadal Oscillation.

The microzooplankton includes larval stages of many macrozooplankton and benthic organisms, as well as heterotrophic protozoan ciliates. Increasingly, researchers are discovering that ciliates are far more numerous than previously thought, largely because they were destroyed in water samples preserved with formalin. The use of more gentle preservatives has shown they are very abundant. Moreover, experimental work has now revealed that not only are these organisms heterotrophic, but they may be responsible for a major portion of phytoplankton grazing, particularly in estuarine and nearshore areas (Sherr and Sherr 2007).

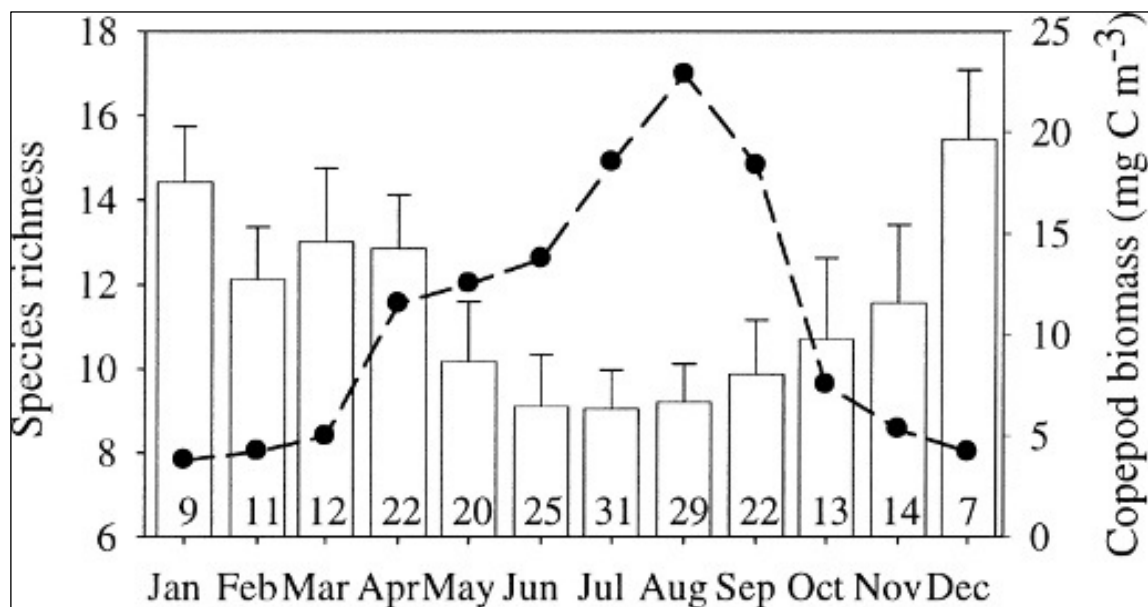

Figure 4.1. Monthly climatology (based on 1996–2004 time period) of biomass (dashed line) and species richness (mean \pm 6SE).

The number of observations per month is indicated at the base of each bar.

From Hooff and Peterson 2006.

4.2 STANDING STOCK OF ZOOPLANKTON

Standing stocks of zooplankton in the Northern Study Area vary greatly and are not readily estimated on an aerial basis by satellites, thus there are no comparable remote sensing estimates of zooplankton similar to those of phytoplankton. Calanoid copepods make up the largest fraction of the coastal zooplankton, with mean abundances as high as 50,000 organisms per m^2 nearshore in summer, to an abundance of less than 100 organisms per m^2 offshore in summer and winter (Landry and Lorenzen 1989).

Although estimates of zooplankton biomass in the California current off southern and central California have shown a considerable decrease over the past six decades (Roemmich and McGowan 1995), there is no evidence for a decline in the northern reaches of the California Current. Sampling has been carried out off Newport Oregon (45N latitude) from 1969-1973, 1977-1978, 1983, 1990-1992 and from 1996 to present and there is no evidence for a change in biomass over this time period (Peterson and Keister 2003); however there has been an increase in copepod species richness (Peterson 2009) that is possibly related to a global warming signal.

4.3 GROWTH AND PRODUCTIVITY

4.3.1 Phytoplankton Growth and Productivity

Phytoplankton growth and productivity in the Northern Study Area is largely controlled by the stability of the water column, and exhibits strong seasonality. In winter, the lack of solar

heating, exacerbated by winter storms, leads to mixing of the upper 50 to 100 m of the water column (Perry et al. 1989). Most phytoplankton are mixed below the critical depth (the depth below which net photosynthesis cannot occur) and standing stocks are typically low. As solar radiation strengthens in the spring, the water column stabilizes and phytoplankton bloom in response to increased sunlight. Abundant nutrients are available for growth in spring allowing substantial growth of phytoplankton. Primary productivity typically remains high during the summer as coastal upwelling bring nutrient-rich bottom water to the surface, resupplying surface waters depletion by growing algae. Algal blooms are typically carried offshore by upwelled water. As fall approaches, phytoplankton productivity drops in response to decreased light; lack of nutrients may also end blooms as seasonal upwelling weakens. Nearshore phytoplankton populations living in proximity to coastal rivers may bloom earlier than those further offshore as the decreased salinity of the surface waters stabilizes the water column. The Columbia River plume creates a unique environment for plankton growth in the Northern Study Area, spreading nutrients and phytoplankton and micro-organism cells broadly across the shelf (Perry et al. 1989). The River Influences on Shelf Ecosystems (RISE) program was an interdisciplinary study of the Columbia River plume effects on phytoplankton standing stocks, growth and grazing rates, and community structure (see synthesis by Hickey et al. 2010). Experiments did not show any inherent difference in phytoplankton net growth or chlorophyll size fractions between the Oregon and Washington coasts, and no evidence for distinction between phytoplankton communities within or outside of the Columbia River plume (Kudela and Peterson, 2009). The influence of the Columbia River plume does show in higher primary productivity and growth in new plume water (Hickey et al. 2010).

Investigations of the mechanisms that create patterns of phytoplankton growth and retention on the continental shelf, as well as modeling efforts to explain their relationship to meteorological forcing, movement of water masses and nutrient dynamics, have been undertaken by a variety of research programs over time, notably the Wind Events and Shelf Transport (WEST) program, funded by the US National Science Foundation (WEST 2010) and other investigators (Botsford et al. 2006) and the Coastal Ocean Advances in Shelf Transport (COAST) Program, funded by the US National Science Foundation (Barth and Wheeler 2005).

Phytoplankton biomass productivity is typically estimated over large areas over time by measuring ocean color by satellite, with ground truthing of data from marine buoys and shipboard experiments. Large numbers of ocean color images from the NASA satellite-mounted SeaWiFS sensor for the Northern Study Area are archived by GLOBEC and can be viewed on the GLOBEC website (GLOBEC 2010). Patterns of phytoplankton growth and productivity vary by season, by sea state, atmospheric disturbance, and by river output. A composite SeaWiFS scan from spring 2000 for the Northern Study Area is shown in [Figure 4.2](#).

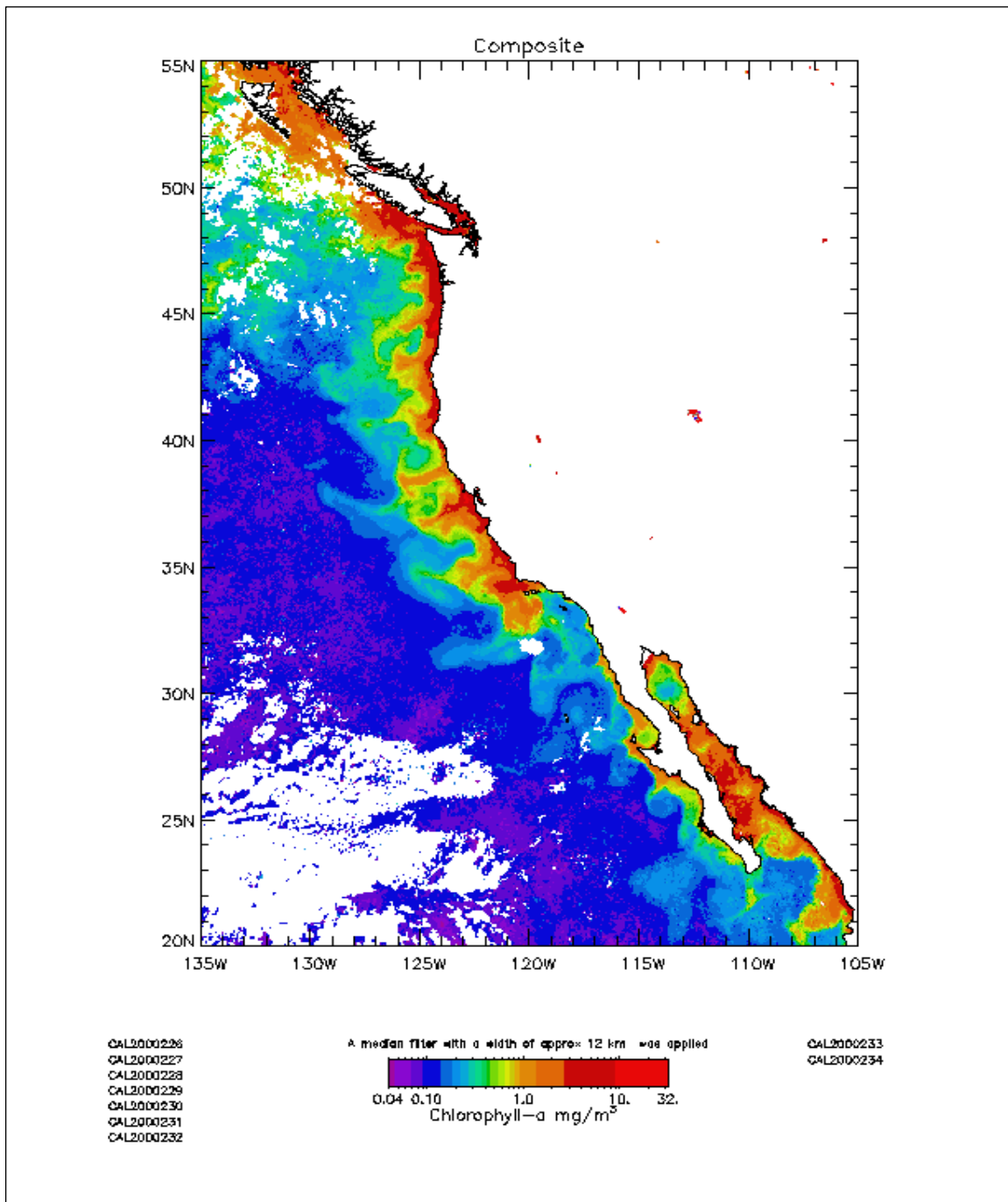

Figure 4.2. Eight day composite of SeaWiFS images, from spring 2000, showing false color surface chlorophyll concentrations.

Image courtesy of Dr. Andrew Thomas of the University of Maine, School of Marine Sciences.

Typical productivity numbers for phytoplankton in the Northern Study Area range from less than 500 mgC/m²/d in winter across the shelf, to greater than 3000 mgC/m²/d during spring and early summer in the midshelf region (Perry et al. 1989) ([Figure 4.3](#)).

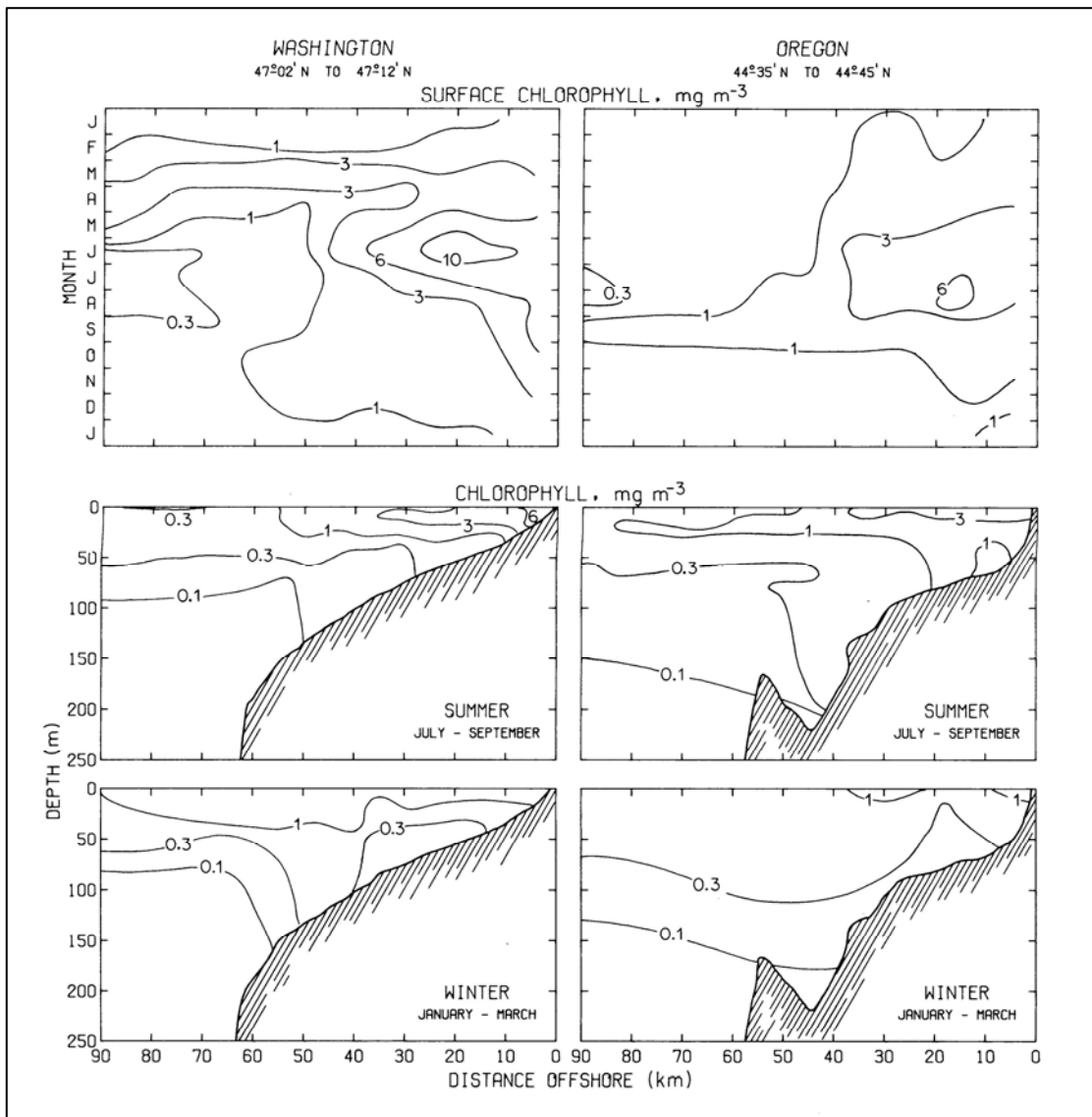

Figure 4.3. Development of surface chlorophyll α features and seasonal depth structure of chlorophyll in waters overlying the shelf regions of Washington and Oregon.

Contours are based on composite measurements made during 1950-1984 from cross shelf transect areas (Copalis Head, WA and Yaquina Head, OR). Data were averaged for months and 5-km distances from shore prior to continuing.

From Landry et al. 1989.

4.3.2 Zooplankton Growth and Productivity

Patterns of zooplankton growth and productivity in the Northern Study Area closely mirror those of the indigenous phytoplankton populations. Adult stages of the most common pelagic zooplankton, including several species of calanoid copepods such as *Neocalanus* spp and *Calanus marshallae* overwinter at depth, emerging as the sunlight increases in the spring. The

copepods begin to swim upwards in the water column, laying eggs, which emerge as juveniles, known as nauplii, ready to exploit the spring phytoplankton blooms (Frost 1993). Years when the phytoplankton bloom is delayed due to weather conditions may result in loss of whole cohorts of pelagic copepods, a starvation scenario that may reverberate through the food chain. Grazing and egg production by calanoid copepods track closely the phytoplankton standing stock, and mirror its timing in a classic predator-prey curve. As phytoplankton abundance decreases in the fall, the larger calanoid copepods mentioned above begin to descend to the depths to overwinter (Landry 2002). GLOBEC investigators monitor copepod growth and productivity during cruises off Newport Oregon periodically (GLOBEC 2009).

The RISE data confirmed that macrozooplankton aggregate near Columbia River plume fronts (Peterson and Peterson 2009). RISE also showed that microzooplankton grazing was lower in the plume near field and north of the river mouth and higher over the shelves south of the river mouth compared to north of it, while macrozooplankton concentration was enhanced at the plume front (Frame and Lessard 2009). RISE investigations included copepod egg production, and euphausiid egg production and molting rates. Biophysical modeling (Banas et al. 2009a, 2009b) showed how the Columbia River has a partial blocking effect, which creates a “shadow zone” in chlorophyll concentrations off northern Oregon and leads to a offshore export of chlorophyll. Export of chlorophyll from the Columbia River estuary to the plume is minimal (Fain et al. 2001; Sullivan et al. 2001).

4.4 SPATIAL AND TEMPORAL PATTERNS

4.4.1 Long-Term Fluctuations

The decline of zooplankton biomass in the Southern California Current, as documented by CalCOFI cruises over more than 60 years indicates that major changes in the coastal ecosystem are taking place in that region, most likely due to climate change (Roemmich and McGowan 1995; Hader et al. 1998). There is no time series of similar length in the Northern California Current, however sufficient sampling has been carried out since 1969 to suggest that there have been no long-term changes in copepod biomass in waters off Oregon (Hoof and Peterson 2006) and Vancouver Island (Mackas et al. 2001, 2007). GLOBEC investigators examine changes in the ocean ecosystem over the Northeast Pacific (GLOBEC 2009); changes in zooplankton biomass and productivity at a single station off Newport Oregon have not elucidated long term changes in biomass (Peterson and Keister 2003), however species richness has increased (Peterson 2009).

On a shorter timescale, major oceanographic forcing functions such as ENSO (El Niño Southern Oscillation) produce episodic changes in water column species from the plankton through the pelagic invertebrates, with waters of the Northern Study Area experiencing lower than normal plankton biomass and levels of productivity during the El Niño phase and higher than normal plankton productivity and biomass during the La Niña phase. These changes can be seen reverberating up through the food chain (Mackas et al. 2001). In addition, the ENSO pattern will cause tropical species to be advected north, resulting in the appearance of plankton and pelagic species not commonly found in the study area, sometimes in sizable numbers (Keister et al. 2005). GLOBEC assessed interannual changes in ocean conditions and correlated those changes

to zooplankton species and biomass at a single station off Newport, Oregon (Peterson and Keister 2003; Keister and Peterson 2003).

4.4.2 Nearshore

Like all temperate nearshore areas, phytoplankton and zooplankton in the nearshore waters of the Northern Study Area are much more abundant than in waters over the Outer Continental Shelf or the open ocean. Seasonal upwelling extends the tongue of dense phytoplankton and zooplankton colonies offshore as well (Keister et al. 2009), but the greatest densities remain nearshore and at midshelf (Peterson et al. 1979; Landry et al. 1989).

4.4.3 Zone of Transition Between Inshore and Offshore Waters

A transition zone or front area at the edge of the continental shelf of the Northern Study Area tends to mark a gradual change in the abundance and species of phytoplankton and zooplankton from coastal species at high concentrations seasonally, to the more oceanic species found in lower numbers throughout the year (Lamb and Peterson 2005). When strong ocean fronts form due to storm activity or basin scale changes, there may be more abrupt changes in density and taxonomic structure. Pelagic invertebrates such as squid and shrimp are more mobile and less at the whim of ocean currents and fronts; however, they can most commonly be found where food is abundant, following the patterns of the plankton.

4.4.4 Offshore

Plankton densities drop away from the coast and reach their lowest average levels in the offshore areas (Keister and Peterson 2003). Predators are thought to follow the same patterns however little work has been done on this topic.

4.5 PELAGIC INVERTEBRATES

In addition to zooplankton that drift at the mercy of currents and waves, there are numerous species of invertebrate nekton that swim independently in the waters of the Northern Study Area, as well organisms such as large jelly fish that drift but are not easily classified as zooplankton due to their size; these jellies include a range of ctenophores and hydroids. Most prominent among the pelagic invertebrates are cephalopods such as squid. Several species of squid are found in the offshore waters including midwater and Humboldt squid. In recent years the latter have become common. Pandalid shrimp are found at mid depths throughout the Northern Study Area near the shelf break; the most common species *Pandalus jordani*, also called the pink shrimp, forms the basis for a small but successful fishery (Anderson 2000; Hannah 1993). Larger planktivorous and carnivorous organisms, including squid, shrimp and jellies, tend to follow their food and can also be found in higher densities nearshore.

Pteropods, pelagic mollusks that swim using translucent appendages that resemble wings, are found in the water column of the Northern Study Area, although most are associated with open ocean environments. These pelagic mollusks are found in surface waters at unpredictable intervals and are believed to be advected into the coastal and shelf waters from the open ocean (Wrobel and Mills 1998).

Most pelagic invertebrates are secondary consumers of phytoplankton (some pandalid shrimp and pteropods) or consumers of small zooplankton (other species of pandalid shrimp and small squid). Larger species of squid and many large jellies (particularly ctenophores) tend to feed higher up the food chain, targeting small fish, and, in the case of the giant squid, larger fish (Caddy and Rodhouse 2004). Pandalid shrimp and squid populations expand with the availability of food; as the water column stabilizes in the spring and during times of strong upwelling, these pelagic species thrive. Jellies tend to enjoy explosive population growth at episodic and unpredictable intervals (Brodeur et al. 2008).

Little is known about changes in abundance or productivity of pelagic invertebrates over time; recent appearances of giant squid in unprecedented numbers off the coast of Oregon and Northern California may be short lived or may suggest a shift in species composition (Caddy and Rodhouse 2004; Field 2008; Nigmatullin et al. 2001). Pelagic invertebrates such as squid and shrimp are more mobile than plankton and less at the whim of ocean currents and fronts; however, they can most commonly be found where food is abundant, following the patterns of the plankton.

4.6 SUMMARY AND DATA GAPS

Growth and distribution of phytoplankton and zooplankton in the Northern Study Area are controlled by oceanographic processes and vary seasonally, reflecting a mix of temperate and boreal species. Seasonal patterns of phytoplankton growth drive the growth and productivity of zooplankton and higher levels of the marine food chain, while herbivorous zooplankton prevent standing stocks of phytoplankton from reaching high concentrations during times of rapid growth in spring, during upwelling events, and during fall turnover. Pelagic invertebrates consist of organisms that spend their lives within the Northern Study Area, as well as some that live primarily in the open ocean, visiting the continental shelf to feed during times of abundant food. The pelagic invertebrates generally follow their planktonic food and exhibit seasonal population increases during summer.

Oceanographic investigations of phytoplankton and zooplankton species in the Northern Study Area are limited to specific research investigations, covering limited areas for short spans of time. Data from these endeavors can be found at the respective websites: GLOBEC (GLOBEC 2010), Coastal Ocean Advances in Shelf Transport (COAST 2010), the US Integrated Ocean Observing Systems (IOOS 2010) and the regional IOOS association: Oregon Coastal Ocean Observing System (OrCOOS 2010), the Northwest Association of Networked Ocean Observing Systems (NanOOS 2010), the Central and Northern California Ocean Observing System (CenCOOS 2010), as well as a salmon forecasting website (<http://www.nwfsc.noaa.gov>) and clicking on “Ocean Index Tools.” In order to determine whether there are species shifts and changes in productivity in the future, it is necessary to establish a comprehensive baseline of phytoplankton and zooplankton productivity such as those established off Vancouver Island (Mackas et al. 2001) and Newport Oregon (Peterson and Keister 2002). Monitoring plankton species would require a multi-year extensive program. Surrogate measures such as remote sensing of chlorophyll from satellites (SeaWiFS primarily) and adequate collection of samples for groundtruthing may be the most effective and efficient way to establish a baseline for the

phytoplankton. Coupled with a small number of focused studies to determine whether zooplankton are following similar patterns in time and space would be helpful.

Similarly, little is known about pelagic invertebrates in the study area. It would be helpful to establish a baseline of population, habitat use, and productivity of the major invertebrate groups. Fisheries surveys routinely gather population data for commercially important organisms; adding other pelagic invertebrates to that list would allow for a cost effective snapshot of the status of the pelagic invertebrates.

Data that detail the effects of climate change on pelagic primary and secondary producers are needed to establish a current baseline of productivity and community composition, against which to compare future measurements. Through the use of measurements of sea surface temperature and pH, exposure curves could be constructed to assess the impacts that future changes will have on the base of the food chain.

4.7 LIST OF LITERATURE CITED—PLANKTON

- Anderson, P.J. 2000. Pandalid shrimp as indicators of ecosystem regime shift. *J. Northw. Atl. Fish. Sc.* 27:1-10.
- Banas, N.S., P. MacCready and B.M. Hickey. 2009a. The Columbia River plume as cross-shelf exporter and along-coast barrier. *Continental Shelf Research* 29(1): 292– 301, doi:10.1016/j.csr.2008.03.011.
- Banas, N.S., E.J. Lessard, R.M. Kudela, P. MacCready, T.D. Peterson, B.M. Hickey and E. Frame. 2009b. Planktonic growth and grazing in the Columbia River plume region: A biophysical model study. *Journal of Geophysical Research*, 114, C00B06, doi:10.1029/2008JC004993.
- Barth, J.A. and P.A. Wheeler. 2005. Introduction to special section: coastal advances in shelf transport. *J. Geophys. Res.* 110, C10S01, doi:10.1029/2005JC003124, 2005.
- Batten, S.D. and D.W. Welch. 2004. Changes in oceanic zooplankton populations in the northeast Pacific associated with the possible climatic regime shift of 1998/1999. *Deep-Sea Research Part II-Topical Studies in Oceanography* 51(6-9):863-873.
- Botsford L.W., C. A. Lawrence, E. P. Dever, A. Hastings and J. Largier. 2006. Effects of variable winds on biological productivity on continental shelves in coastal upwelling systems. *Deep Sea Research Part II: Topical Studies in Oceanography.* 53:25-26, 3116-3140.
- Brodeur, R.D., C.L. Suchman, D.C. Reese, T.W. Miller and E.A. Daly. 2008. Spatial overlap and trophic interactions between pelagic fish and large jellyfish in the Northern California Current. *Marine Biology* 154 (4):649-659.
- Caddy, J.F. and P.G. Rodhouse. 2004. Cephalopod and Groundfish landings: Evidence for ecological change in global fisheries? *Reviews in Fish Biology and Fisheries* 8(4):431-444.

- CenCOOS. 2010. Central and Northern California Ocean Observing System. <http://www.cencoos.org/>. Accessed January 24, 2010.
- COAST. 2010. Coastal Ocean Advances in Shelf Transport <http://damp.coas.oregonstate.edu/coast/>. Accessed January 24, 2010.
- Fain, A.M.V., D.A. Jay, D.J. Wilson, P.M. Orton and A.M. Baptista. 2001. Seasonal, monthly and tidal patterns of particulate matter dynamics in the Columbia River estuary. *Estuaries and Coasts* 24:770–786, doi:10.2307/1352884.
- Field, J. 2008. Jumbo squid (*Dosidicus gigas*) invasions in the Eastern Pacific Ocean symposium introduction. *CalCOFI Rep.* 49:79-81.
- Frame, E.R. and E.J. Lessard. 2009. Does the Columbia River plume influence phytoplankton community structure along the Washington and Oregon coasts? *Journal Geophysical Research*, 114, C00B09, doi:10.1029/2008JC004999.
- Frost, B.W. 1993. A modeling study of processes regulating plankton standing stock and production in the open sub-arctic Pacific Ocean. *Progress in Oceanography* 32 (1-4):17-56.
- GLOBEC. 2009. Ocean Ecosystem Indicators Update. 2009. Annual Report. <http://www.nwfsc.noaa.gov/research/divisions/fed/oeip/b-latest-updates.cfm>. January 24th 2010.
- GLOBEC. 2010. Globec NE Pacific Project Satellite Data Archive <http://coho.coas.oregonstate.edu/#seawifs>. January 24, 2010.
- Grantham, B.A., F. Chan, K.J. Nielsen, D.S. Fox, J.A. Barth, A. Huyer, J. Lubchenco and B.A. Menge. 2004. Upwelling-driven nearshore hypoxia signals ecosystem and oceanographic changes in the northeast Pacific. *Nature* 429:749-754.
- Hader, D.P., H. D. Kumar, R.C. Smith and R.C. Worrest. 1998. Effects on aquatic ecosystems. *Journal of Photochemistry and Photobiology B-Biology* 46(1-3):53-68.
- Hannah, R.W. 1993. Influence of environmental variation and spawning stock levels on recruitment of ocean shrimp (*Pandalus jordani*). *Can. J. Fish. Aquat. Sci.* 59:612-622.
- Hickey, B.M., R.M. Kudela, J.D. Nash, K.W. Bruland, W.T. Peterson, P. MacCready, E.J. Lessard, D.A. Jay, N.S. Banas, A.M. Baptista, E.P. Dever, P.M. Kosro, L.K. Kilcher, A.R. Homer-Devine, E.D. Zaron, R.M. McCabe, J.O. Peterson, P.M. Orton, J. Pan and M.C. Lohan. 2010. River Influences on Shelf Ecosystems (RISE): Introduction and Synthesis. *Journal of Geophysical Research* 115, C00B17, doi: 10.1029/2009JC005452.
- Hooff, R.C. and W.T. Peterson. 2006. Copepod biodiversity as an indicator of changes in ocean and climate conditions of the Northern California current ecosystem. *Limnol. Oceanogr.*, 51(6), 2006, 2607–2620

- IOOS. 2010. Integrated Ocean Observing System. <http://ioos.gov/>. January 24, 2010.
- Keister, J.E., T. B. Johnson, C. A. Morgan and W. T. Peterson. 2005. Biological indicators of the timing and direction of warm-water advection during the 1997/98 El Niño off the central Oregon coast, USA. *Mar. Ecol. Prog. Ser.* 295:43-48.
- Keister, J.E. and W.T. Peterson. 2003. Zonal and seasonal variations in zooplankton community structure off the central Oregon coast, 1998-2000. *Progress in Oceanography* 57(3-4):341-361.
- Keister, J.E., W.T.Peterson and S.D.Pierce. 2009. Zooplankton distribution and cross-shelf transfer of carbon in an area of complex mesoscale circulation in the Northern California Current. *Deep-Sea Res I* 56:212-231.
- Kudela, R.M. and T.D. Peterson. 2009. Influence of a buoyant river plume on phytoplankton nutrient dynamics: What controls standing stocks and productivity? *Journal of Geophysical Research* 114, C00B11, doi:10.1029/2008JC004913.
- Lamb, J. and W. Peterson. 2005. Ecological zonation of zooplankton in the COAST study region off central Oregon in June and August 2001 with consideration of retention mechanisms, *J. Geophys. Res.*, 110, C10S15, doi:10.1029/2004JC002520.
- Landry, M.R. 2002. Integrating classical and microbial food web concepts: Evolving views from the open-ocean tropical Pacific. *Hydrobiologia* 480(1-3):29-39.
- Landry, M.R., C.J. Lorenzen. 1989. Abundance, distribution, and grazing impact of zooplankton on the Washington Shelf. In: M. R. Landry and B. M. Hickey. *Coastal Oceanography of Washington and Oregon*. Amsterdam: Elsevier. 175-210.
- Landry, M.R., J.R. Postel, W.K. Peterson and J. Newman. 1989. Broad Scale Distributional Patterns of Hydrographic Variables on the Washington/Oregon Shelf. In: M. R. Landry and B. M. Hickey. *Coastal Oceanography of Washington and Oregon*. Amsterdam: Elsevier. 1-40.
- Mackas, D.L., S. Batten and M. Trudel. 2007. Effects on zooplankton of a warmer ocean: Recent evidence from the Northeast Pacific. *Progress in Oceanography* 75(2):223-252.
- Mackas, D.L., R.E. Thomson and M. Galbraith. 2001. Changes in the zooplankton community of the British Columbia continental margin, 1985-1999, and their co-variation with oceanographic conditions. *Canadian Journal of Fisheries and Aquatic Sciences* 58(4):685-702.
- NANOOS. 2010. Northwest Association of Networked Ocean Observing Systems. <http://www.nanoos.org/>. January 24, 2010

- Nigmatullin, Ch. M., K.N. Nesis and A.I. Arkhipkin. 2001. A review of the biology of the jumbo squid *Dosidicus gigas* (*Cephalopoda: Ommastrephidae*). *Fisheries Research* 54(1):9-19.
- OrCOOS. 2010. Oregon Coastal Ocean Observing System. <http://agate.coas.oregonstate.edu/>. Accessed January 24, 2010
- Perry, M.J., J.P. Bolger and D.C. English. 1989. Primary production in Washington Coastal Waters. In: M. R. Landry and B. M. Hickey. *Coastal Oceanography of Washington and Oregon*. Amsterdam: Elsevier. 117-173.
- Peterson, W. 2009. Copepod species richness as an indicator of long term changes in the coastal ecosystem of the Northern California Current. *CalCOFI Reports* 50: 73-81
- Peterson, W.T. and J.E. Keister. 2002. The effect of a large cape on distribution patterns of coastal and oceanic copepods off Oregon and Northern California during the 1998–1999 El Niño–La Niña. *Progress in Oceanography* 53(2-4): 389-411.
- Peterson, W.T. and J.E. Keister. 2003. "Interannual variability in copepod community composition at a coastal station in the Northern California Current: a multivariate approach." *Deep-Sea Research II* 50: 2499-2517.
- Peterson, W.T., C.B. Miller and A. Hutchinson. 1979. Zonation and maintenance of copepod populations in the Oregon upwelling zone. *Deep-Sea Res.* 26A:467-494
- Peterson, J.O. and W.T. Peterson. 2009. The influence of the Columbia River plume on cross-shelf transport of zooplankton. *Journal Geophysical Research*, 114, C00B10, doi:10.1029/2008JC004965.
- Roemmich, D. and J. McGowan. 1995. Climatic warming and the decline of zooplankton in the California Current *Science* 267(5202):1324-1326.
- Sherr, E.B. and B.F. Sherr. 2007. Heterotrophic dinoflagellates: a significant component of microzooplankton biomass and major grazers of diatoms in the sea. *Mar Ecol Prog Ser.* Vol. 352: 187–197, 2007, doi: 10.3354/meps07161.
- Sullivan, B.E., F.G. Prahl, L.F. Small and P.A. Covert. 2001. Seasonality of phytoplankton production in the Columbia River: A natural or anthropogenic pattern? *Geochimica Cosmochimica Acta*, 65:1125–1139, doi:10.1016/S0016-7037(00)00565-2.
- Trainer, V.L., Barbara M. Hickey and Rita A. Horner. 2002. Biological and physical dynamics of domoic acid production off the Washington Coast. *Limnol Ocean* Vol. 47(5):1438-1446.
- WEST 2010. Wind Events and Shelf Transport. NSF-funded study of the role of wind-driven transport in shelf productivity. Internet web site <http://iod.ucsd.edu/research/west/>. Accessed 21 June 2010.

Wrobel, D. and C. Mills. 1998. Pacific Coast Pelagic Invertebrates: A Guide to the Common Gelatinous Animals. Sea Challengers. 108.

5. MACROPHYTES

Macrophytes in the Northern Study Area include macroalgae--commonly called “seaweed”--eelgrass, and a variety of emergent marsh plants. Macroalgae is a multicellular plant that may be anchored to a hard surface or free floating, but has no roots (Druehl 1981); macroalgae derive nutrients from seawater. Eelgrass, a subset of seagrass, and a variety of plants, known cumulatively as marsh plants, are vascular, rooted plants, deriving nutrients from the sediment. Macroalgae, seagrasses, and marsh plants are found all along the coastline of the Northern Study Area wherever appropriate habitat can be found that allows the plants to grow in the photic (or sunlit) zone—generally 30 meters depth or less, year round. Macrophytes in the Northern Study Area follow typical patterns of temperate zone growth, with rapid growth of vegetative structures in spring and summer, and annual dieback in winter (Murray and Bray 1993). Excessive exposure, swift currents, strong waves, and high winds may further limit the presence of these marine plants in the Northern Study Area. The same genera and species of macroalgae, seagrasses, and marsh plants are found throughout the Northern Study Area, with geographic differences among species found in the area more closely correlated with conditions of substrate, open water exposure, and salinity than with any north-to-south pattern. The continental slope of the Northern Study Area ensures that macrophytes are restricted to nearshore areas, with very little growth more than a mile from shore (Druehl 2001). There have been few focused studies on macroalgae in the Northern Study Area since 1997 (Blanchette et al. 2008).

5.1 FLORISTICS AND BIOGEOGRAPHY

Macrophytes (with the exception of floating algae) must be anchored to hard surfaces (in the case of seaweeds), or in sediment (for seagrasses or marsh plants). Sunlight penetrates only the surface layer of the ocean, ensuring that macrophytes grow close to shore, generally in less than 30 meters of water in the Northern Study Area. Floating seaweeds can be found farther from shore, but these plants are found in only a few select areas and make up only a very small and unpredictable portion of the macrophytes. The Northern Study Area represents temperate zone flora, with growth and die-off controlled primarily by light, and secondarily by the availability of dissolved nutrients in the water. In the temperate zone, macrophytes characteristically display rapid spring growth as sunlight becomes available, varying patterns of summer growth depending on the nutrient regime, fall dieback, and senescence or exceptionally low growth in the winter, due to light limitation (Mondragon and Mondragon 2003).

Macroalgae may be annuals, dying back each winter, or perennials, regrowing from previous plants each spring. These plants reproduce vegetatively but may also reproduce sexually, allowing for stronger genetic variability and greater spread across areas (Druehl 2001). Three major seaweed groups are found in the Northern Study Area: green algae, red algae, and brown algae (Mondragon and Mondragon 2003). There are hundreds of species of green algae in the Northern Study Area, the most common of which are *Ulva* spp. and *Enteromorpha* spp. While *Ulva* may be free floating, other green algae are attached to hard substrates. Brown macrophytes in the Northern Study Area are represented by several species of kelp including *Laminaria*, *Macrocystis* and *Nereocystis*, by rockweeds, and by fucoids including *Fucus* spp., *Sargassum* spp. and others. A nonnative species *Sargassum muticum* has invaded subtidal areas of several

embayments in the Northern Study Area, causing displacement of other macroalgae and disrupting food chains (Britton-Simmons 2004).

5.2 PATTERNS OF STRUCTURE AND SEASONAL-INTERANNUAL VARIATION OF COMMUNITIES

5.2.1 Embayments: Salt Marshes, Lagoons, Modified Estuaries

The Northern Study Area has several large and many small estuaries and bays that provide subtidal, intertidal and nearshore habitat that supports macrophytes (largely on rocky habitat), seagrasses, and many species of emergent marsh grasses. The bays and estuaries include tectonic estuaries like Tomales Bay, drowned river estuaries like Grays Harbor and San Francisco Bay, and river mouths opening to the ocean like Yaquina Bay and Alsea Bay.

Seagrasses are found in soft sediments within embayments throughout the Northern Study Area from the limit of the photic zone subtidally through the intertidal zone. The meadows are dominated by eelgrass, *Zostera marina*, with some invasion by the nonnative *Zostera japonica* in the higher intertidal areas (Larkum et al. 2006). Eelgrass is an annual plant, dying back each winter and regrowing from underground rhizomes the following spring. Localized changes in biomass of eelgrass have been noted in parts of the Northern Study Area; most have been attributed to encroachment by human activities, particularly shoreline development, or invasion by the nonnative *Z. japonica*, which grows high in the intertidal, forcing *Z. marina* into a more restricted habitat (Thom and Hallum 1990). Ironically the states in the Northern Study Area do not distinguish between the native *Z. marina* and the nonnative *Z. japonica*, protecting each equally. For example in Washington State, regulations protecting eelgrass refers to *Zostera* spp. (State of Washington 2003).

Marsh plants that dominate the fringes of embayments of the Northern Study Area straddle the range from freshwater to brackish to salt marshes and are dominated by species of emergent plants that best suit the salinity, temperature, and nutrient regime locally (Packham and Willis 1997). Typical salt marsh plants include *Salicornia virginica* (known as “pickleweed”) and *Carex lyngbyaei*. Most embayments support a unique mix of marsh plants, due to specific conditions of substrate, exposure to wind and waves, and salinity regimes; however, the mix does not change markedly over the Northern Study Area (Packham and Willis 1997). Salt marshes in the mid to lower intertidal areas of the Northern Study Area have been subjected to pressure from invasive *Spartina* spp. over the past several decades. *Spartina*, native to the eastern United States, is an aggressive invader that takes over unvegetated mudflats and competes with marsh grasses (Civille et al. 2005). There are four species of invasive *Spartina*, most of U.S. East Coast or European origin, present in the Northern Study Area. All four species are known to spread vegetatively, while one, *Spartina anglica*, has adapted sufficiently to also spread sexually by seeds (Major et al. 2003). Willapa Bay and Grays Harbor in southwest Washington State have been particularly hard hit by *Spartina* invasions. Willapa Bay hosts more than three-quarters of the State’s thriving shellfish area; invasions by *Spartina alterniflora* have severely impacted harvest of bottom-cultured oysters (Civille et al. 2005). Willapa Bay and Grays Harbor are important stops on the Pacific Flyway, hosting annual stopovers of hundreds of thousands of migrating seabirds and waterfowl (Warnock and Takekawa 2004). The fast-

growing *Spartina* meadows prevent migrating birds from landing and feeding on the productive mudflats, further stressing many species. Attempts to eradicate *Spartina* with mechanical and chemical means have not brought the invader under control (Civille et al. 2005).

Saltwater lagoons formed by wave-induced sediment drift occur sporadically along the coastline and in the larger estuaries. These lagoons are impermanent, occasionally overtopped by winter storms, opening the trapped water and biota to the estuary or open coastline. Many of the estuaries in the study area have been severely modified by human activities, including hardening of the shorelines, modification of nearshore habitat, and disposal of contaminants. These modifications tend to change the extent and patterns of macrophyte distribution in nearshore areas. Elimination of coastal wetlands has reduced the extent of marsh grass acreage in all the developed estuaries and bays (Packham and Willis 1997); the habitats of the outer coast are less impacted than the coastal wetlands and estuaries (Thom and Hallum 1990).

5.2.2 Rocky Intertidal

Rocky intertidal habitat provides excellent purchase for macroalgae that have developed holdfasts, including a variety of red, brown, and green algae, most notably several species of *Fucus* and *Sargassum*. Floating green algae, including *Ulva* spp. and *Enteromorpha* spp., may also be found in close proximity to rocky habitats. Macroalgae biomass in rocky areas may build up over the growing season, reaching deep piles and layers of vegetation in areas where wave energy is limited (Mondragon and Mondragon 2003). In the Northern Study Area, the more exposed coastlines tend to have less macrophyte biomass, as physical forces tend to break fronds and inhibit secure holdfasts (Blanchette et al. 2008). Seaweed fronds are often broken by waves and wind action, creating floating mats; most of these broken fronds do not grow but may float for a period of time before sinking. Large buildups of macroalgae may cause shading of underlying layers, facilitating decay and decomposition of the under layers. The species mix of macrophytes differs little throughout the Northern Study Area, although individual bays, estuaries and coastlines may sport a mix of algal species that differs from the mix in areas with differing conditions of wind, weather, and extent of rocky substrate; biomass levels may also differ markedly among bays (Blanchette et al. 2008).

5.2.3 Subtidal Kelp Forests

Kelp forests are present in the subtidal areas throughout the Northern Study Area, although the beds tend to be episodic and noncontinuous in spatial extent (Mumford 2007). Portions of shorelines may have intermittent rocks and other solid substrate subtidally, allowing kelp forests to grow in noncontinuous lines. It has been noted in many locations in the Northern Study Area that kelp beds may be present along certain shorelines one year, and disappear in subsequent years (Mumford 2007). The causal mechanisms for these changes are unclear; however, weather conditions, terrestrial contamination, and climate change have been postulated as forcing factors (Thom and Hallum 1990).

Kelp forests in the Northern Study Area are annual; the plants die back in fall as light levels drop, then regrow from holdfasts the following spring. There are many species of kelp in the Northern Study Area; the dominant species include *Laminaria saccharina*, *Macrocystis integrifolia*, and *Nereocystis luetkeana*. Kelp is a macroalgae that grows in water typically 6 to

30 feet deep and is tethered to hard surfaces by a holdfast. A thick rope-like stalk extends toward the surface from the holdfast. Broad leaves grow annually on the stalks and are arrayed in the surface and near-surface water. Kelp forests form important habitat for a wide variety of species, sheltering and providing food for juvenile fish and other organisms within the canopy. Loss of kelp beds can profoundly affect recruitment and survival of fish and invertebrate species in nearby waters and shorelines.

5.2.4 Floating Macroalgae

Several species of macroalgae are not attached to substrate but propagate in open water, drifting with water masses. In the Northern Study Area, the dominant species include *Ulva* sp. and *Ulvaria obscura*. Floating macroalgae form mats, up to a meter thick, creating important habitat for many planktonic organisms, as well as important shelter for juvenile fish and other nektonic species. These floating algal mats are episodic and unpredictable, although a few areas are known to accumulate the algae, probably due to nearshore circulation patterns (Shaffer et al. 2008).

5.3 MACROPHYTE PRODUCTIVITY

Seaweeds are some of the most productive plants on Earth and can grow exceptionally fast under optimum conditions of light and nutrients. Eelgrass and marsh grasses grow more slowly (Thom et al. 2003) but can accumulate large biomass over the growing season as they are less susceptible to being torn loose by wind and waves. Net productivity of eelgrass along the Pacific Coast ranges from 300-375 gC/m² (Thom 1990). Typical production rates for nearshore macrophytes in the Northern Study Area are about 9,000 metric tons per hectare (Thom 1990). Peak rates of eelgrass photosynthesis occur in late summer, but productivity is greatest in spring as summer temperatures tend to inhibit growth (Dennison 1987).

5.4 COMMERCIAL AND RECREATIONALLY IMPORTANT SPECIES

Kelp and some rockweed species are harvested for food and food products including agars and other proteins. Although there is currently little utilization of macroalgae for commercial purposes in the Northern Study Area, several species of indigenous seaweeds are exploited for food, fiber, and specialty carbohydrates in other countries, most notably China, Korea, and Japan (Druehl 2001). The sea palm (*Postelsia palmaeformis*), a form of kelp, is harvested for recreational purposes in limited areas of the Northern Study Area, and is protected in the State of California (Miller 2003). There is little other recreational use of macrophytes directly in the area; however, the habitat provided by marsh grasses and seagrasses is essential as a nursery ground, as a refuge, and often as a source of food for juvenile and adult forms of many marine species including Dungeness crab. The fringing marshes are also important habitat for migrating waterfowl and seabirds along the Pacific Flyway (Warnock and Takekawa 2004).

5.5 SUMMARY AND DATA GAPS

Macrophytes include seaweeds as well as rooted plants like seagrasses and marsh plants. Macrophytes grow in the nearshore region of the Northern Study Area. Interannual variation in productivity and aerial extent can vary due to weather conditions. Better aerial maps of the presence of macrophytes in the Northern Study Area would allow a better assessment of areas at

risk from human disturbance. A better understanding of the role of invasive algae, seagrasses, and marsh grasses is needed as climate change continues to put additional pressure on macrophyte communities and the habitats they create.

5.6 LIST OF LITERATURE CITED—MACROPHYTES

- Batten, S.D. and D.W. Welch. 2004. Changes in oceanic zooplankton populations in the north-east Pacific associated with the possible climatic regime shift of 1998/1999. *Deep-Sea Research Part II. Topical Studies in Oceanography* 51(6-9):863-873.
- Blanchette, C.A., C.M. Miner, P.T. Raimondi, D. Lohse, K.E.K. Heady and B.R. Broitman. 2008. Biogeographical patterns of rocky intertidal communities along the Pacific Coast of North America. *Journal of Biogeography* 35(9):1593-1607.
- Britton-Simmons, K.H. 2004. Direct and indirect effects of the introduced alga *Sargassum muticum* on benthic, subtidal communities of Washington State, USA. *Marine Ecology Progress Series* 277:61-78.
- Civille, J.C., K. Sayce, S.S. Smith and D.R. Strong. 2005. Reconstructing a century of *Spartina alterniflora* invasion with historical records and contemporary remote sensing. *Ecoscience* 12 (3):330-338.
- Dennison, W.C. 1987. Effects of light on seagrass photosynthesis, growth and depth distribution. *Aquatic Botany* 27(1):15-26.
- Druehl, L.D. 1981. Geographical distribution. *The biology of seaweeds* (ed. by C.S. Lobban and M.J. Wynne), pp. 306-325. University of California Press, Berkeley, CA.
- Druehl, L. D. 2001. *Pacific seaweeds*. Madeira Park, BC: Harbour Publishing. 192 pp.
- Larkum, A.W.D., R.J. Orth and C.M. Duarte. 2006. *Seagrasses: Biology, ecology and conservation*. New York: Springer. 691 pp.
- Major, W.W. III, C.E. Grue, J.M. Grassley and L.L. Conquest. 2003. Mechanical and chemical control of smooth cordgrass in Willapa Bay, Washington. *Journal of Aquatic Plant Management* 41:6-12.
- Miller, K. A. 2003. Sea Palm. Chapter 3 in *Annual Status of the Fisheries through 2003*. Report to the Fish and Game Commission prepared by California Department of Fish and Game Marine Region, December 2004. http://www.dfg.ca.gov/marine/asfr_2003.pdf.
- Mondragon, J. and J. Mondragon. 2003. *Seaweeds of the Pacific Coast: Common marine algae from Alaska to Baja California*. Sea Challengers. 97pp.
- Mumford, T. F., Jr. 2007. *Kelp and Eelgrass in Puget Sound*. Puget Sound Nearshore Partnership Report No. 2007-05. Published by Seattle District, U.S. Dept. of Defense, Army Corps of Engineers, Seattle, Washington. 34 pp.

- Murray, S.N. and R.N. Bray. 1993. 7. Benthic Macrophytes. University of California Press. Pp 304-368.
- Packham, J.R. and A.J. Willis. 1997. Ecology of dunes, salt marsh and shingle. New York: Springer. 352 pp.
- Shaffer, J.A., P. Crain, B. Winter, M.L. McHenry, C. Leard and T.J. Randle. 2008. Nearshore restoration of the Elwha River through Removal of the Elwha and Glines Canyon dams: An overview. Northwest Science 82(1).
- State of Washington. 2003. Saltwater Habitats of Special Concern. Washington Administrative Code 220-110-250. State of Washington, Olympia WA. <http://apps.leg.wa.gov/WAC/default.aspx?cite=220-110-250>.
- Thom, R. 1990. Spatial and temporal patterns in plant standing stock and primary production in a temperate seagrass system. *Botanica Marina* 33(6): 497-510.
- Thom, R. and L. Hallum. 1990. Long Term Changes in the Areal Extent of Tidal Marshes, Eelgrass Meadows and Kelp Forests of Puget Sound. Final Report to the Office of Puget Sound, Region 10, U.S. Environmental Protection Agency. Seattle. 116 pp.
- Thom, R.M., A.B. Borde, S. Rumrill, D.L. Woodruff, G.D. Williams, J.A. Southard and S.L. Sargeant. 2003. Factors influencing spatial and annual variability in eelgrass (*Zostera marina* L.) meadows in Willapa Bay, Washington, and Coos Bay, Oregon, estuaries. *Estuaries and Coasts* 26(4):1117-1129.
- Warnock, N. and J. Y. Takekawa. 2004. Migration and stopover strategies of individual Dunlin along the Pacific Coast of North America. *Canadian Journal of Zoology-Revue Canadienne De Zoologie* 82(11): 1687-1697.

6. BENTHOS

Extensive research and monitoring of benthic habitats and assemblages were conducted in the coastal region of the Northern Study Area during the 1960s and 1970s. The description and review prepared in 1977 for the Bureau of Land Management provided details of habitats, benthic assemblages, and their interactions with other organisms (Oceanographic Institute of Washington and Human Resources Planning 1977) for the Washington and Oregon coasts, with emphasis on Northern California. Some nearshore habitats have been altered since the late 1970s and some benthic assemblages have changed due to exploitation, climate change, and other factors. In general, however, the habitats and benthic assemblages, particularly those at depth, have changed very little. This chapter will focus on the portions of the Northern Study Area not well covered by the 1977 report, as well as changes in habitats, benthic assemblages, and studies that have examined the benthic communities from a new perspective.

6.1 BENTHIC HABITATS AND ASSEMBLAGES

Benthic organisms, those animals and plants that live in proximity to the bottom, are generally sessile (attached by a base) or slow moving and tend to be associated with a single habitat type throughout their adult lives. Unlike plankton that must be light and mobile, benthic organisms can grow much larger and take on extraordinary body shapes and sizes. Benthic habitats are formed by physical and chemical oceanographic forces, proximity to land, and occasionally by the presence of other organisms, such as oyster reefs and coral outcroppings.

Benthic habitats are generally divided into soft-bottom (mud, silt, sand) and hard-bottom (bedrock, boulders, large cobble, coral) types. Soft-bottom habitats are characterized by sediment grain size, organic content, and porosity. Habitats are further characterized by the depth of water, starting with the intertidal, through the shallow subtidal, and seaward to the continental shelf and deep sea. Benthic habitats are also affected by the latitude and prevailing wind and weather, with the more changeable habitats in intertidal and shallow-water areas where they are affected by air temperature, waves, and wind. Deep-sea habitats are much more stable.

A group of benthic plants and animals that live together in a habitat make up a benthic assemblage. The mix of plants and animals in a particular assemblage can often be found in similar habitats in other regions. Alterations in habitats generally stress the associated benthic assemblage, often creating changes in the mix of organisms and/or the loss of benthic biomass (Kennedy and Jacoby 1999).

Benthic organisms live a wide variety of lifestyles, often altering their body types to fit the habitat and food supply. Benthic organisms living in high-energy regimes, such as the intertidal or surf zone, adapt so they can cling to hard substrates. Those in soft-bottom environments may live loosely on the surface, moving slowly to capture food, or may burrow into the sediment and wait for food to float by in the overlying water.

Biologists classify benthic organisms by their lifestyle. Epifauna live on top of substrate and include intertidal organisms such as mollusks clamped onto rocks or slow-moving organisms such as sea cucumbers living in deeper water on top of sandy or silty substrates. Infauna live

burrowed into the sediment, sometimes in tubes or burrows of their own construction and sometimes living freely among the sand grains. Infauna are further subdivided by size classes, although definitions of these size classes may vary. The microfauna, meiofauna, macrofauna, and megafauna represent increasingly large size classes of organisms and typically form the focal points of most benthic community studies. Microfauna are micro-organisms such as marine bacteria; meiofauna are animals, such as harpacticoid copepods and nematode worms, that pass through a 0.3-mm-mesh sieve but are retained on a 0.063-mm-mesh sieve. Macrofauna, such as amphipods and polychaete worms, pass through a 1.0-mm-mesh sieve but are retained on a 0.3-mm-mesh sieve. Megafauna, such as large crustaceans and echinoderms, are larger than 1 cm (Gage 2001). These size differentiations are useful in describing the assemblages of benthic organisms living in a habitat. The smaller the sediment grain size, the smaller the organisms living among the grains are likely to be.

Benthic organisms generally have planktonic larvae that allow them to spread their offspring across habitats and to new areas. Once benthic larvae metamorphose and settle down, most do not move far. Many species, such as barnacles, cement their bodies to rocks or other hard substrates, while others, such as polychaete worms, may move about in tubes or burrows, abandoning their homes to build new ones within a few centimeters. A few benthic species move slowly about the bottom in search of food, including nudibranchs, sea cucumbers, and crab. Some benthic species are fully motile, moving rapidly across the bottom. Motile benthos are generally larger than their slow-moving or sessile brethren, often less fearful of predation because they are armored (such as crabs) or unappealing as prey (such as sea cucumbers).

A wide variety of benthic habitats and assemblages occur in the Northern Study Area. Intertidal benthic habitats include mud and sand flats, open sandy beaches, and rocky shorelines. Subtidal habitats consist of rocky subtidal areas including rocky reefs, sand, and mud bottoms. Benthic habitats deeper than 200 m are shaped by unique physical, chemical, and biological properties. Increased pressure, decreased temperature, and lack of light create radically different species assemblages than those in the shallow benthos.

6.1.1 Shallow Intertidal and Subtidal Habitats and Benthic Assemblages

Intertidal habitats and shallow subtidal habitats (generally areas of water depths less than ~30 m) may support macroalgae and other plant forms, unless physical scouring prevents plants from taking hold. These vegetated habitats generally support much larger biomasses of benthic animals than those in deeper habitats (Garrison 1999). Tremendous diversity in habitats and biota exists within this range, with each area supporting a different assemblage of benthic organisms.

6.1.1.1 Rocky Intertidal

Benthic organisms that live in the rocky intertidal must be able to withstand desiccation between high tides, strong forces of waves, storm surges, and spring tide, as well as predation by marine and terrestrial organisms. Benthic intertidal organisms are generally sessile. Strategies for maintaining their positions include: strongly attached to rocks for their entire life, like barnacles; attached in a less-permanent manner like mussels attached by byssal threads; able to retreat to small crevices or holes like limpets; or clamped down on rocks with considerable force like

chitons. Benthos in the rocky intertidal vie for space, as space equates to food availability. Many sessile intertidal organisms engage in chemical warfare, exuding deleterious chemicals that keep other species from encroaching into their territory (Minchinton and Seiberling 1993).

Rocky intertidal communities on the open coast of the Northern Study Area are characterized by distinct biotic zones (Menge 2000). Rocky subtidal habitats support tunicates, sponges, coralline algae, sea urchins, and other flora and fauna that prefer hard substrates. The low intertidal zone is characterized by a variety of algal species, including a filamentous red alga (*Endocladia*) and at least two brown algal taxa (*Hedophyllum* and *Lessoniopsis*) (Paine 1974). The middle intertidal zone is dominated by a mussel (*Mytilus*) and the high intertidal zone is comprised of furoid algae and barnacles (Menge 2000).

This zonation pattern results from a combination of physical and biological factors. Generally, the upper limit of the mussel zone is set by the level of desiccation that mussels can tolerate during exposure to air, although high temperatures also affect their distribution (Petes et al. 2008) as do occasional catastrophic freezes (Denny and Paine 1998). The lower limit of the zone is determined by the upper limit of the sea star *Pisaster*, a key mussel predator that does not enter the middle intertidal zone (Paine 1974). Intertidal zonation limits appear to fluctuate on a long-term cycle related to variations in lunar inclination that affect the degree of tidal exposure (Denny and Paine 1998).

This general zonation pattern changes geographically along the coast of the Northern Study Area. Connolly and Roughgarden (1998) compared intertidal communities in Oregon and Northern to Central California and found that mussels and barnacles (*Balanus*) had greater cover in Oregon where algal cover was lower. The difference may be related to the differential availability of larvae to colonize habitats in regions of strong offshore currents (California) versus weak offshore currents (Oregon). When mussels do not recruit well in Northern California, less competitive species of algae can colonize. Schoch et al. (2006), using a spatially nested sampling design from San Diego, California to the Strait of Juan de Fuca, found that biotic diversity in the low intertidal zone decreases from north to south at relatively small scales (transect or site), but the trend is less clear at a larger scale (area) or may be reversed at a very large scale (hundreds of kilometers). Middle and high intertidal zonation showed little latitudinal variation in diversity.

Schoch et al. (2006) concluded that wave runup is the single most important physical factor explaining local differences in rocky intertidal community structure. Wave runup is the distance that water from breaking waves travels across the intertidal zone beyond normal still-water tidal levels. Runup brings water into areas that would otherwise be dry, providing food for animals and reducing the threat of desiccation. This inundation results in a greater vertical zonation extent for many animals, beyond what would occur at still-water levels. Runup generally decreased from north to south in the Northern Study Area and depends on several factors, including wave height and shoreline features. Waves play another important role, battering the mussel zone with logs and other debris and creating new spaces that can be colonized by biota that mussels would otherwise outcompete.

6.1.1.2 Sandy Beaches

The open coastal areas of the Northern Study Area include many sand beaches that provide difficult environmental conditions for the resident biota. Sand beaches are constantly changing as winter storms remove sand, which is redeposited during quiet summer periods, and are found throughout the Northern Study Area wherever rocky headlands and river mouths are not predominant (Ricketts et al. 1985). Beaches typically house fewer species and smaller populations than open-coast rocky shores. Most animals adapt to dynamic beach conditions by burrowing into the sand.

Fauna include relatively short-lived mobile crustaceans, such as mole crabs and amphipods, and long-lived, deeper-burrowing mollusks, such as razor and Pismo clams (Ricketts et al. 1985). Populations of the shorter-lived animals can vary substantially from year to year. The mobile benthos, such as crabs and other crustaceans, are more likely to be swept away during adverse conditions. Their biomass decreases significantly in winter. Benthos that can burrow deeper into the sand are less susceptible to winter wind and wave conditions; however, these organisms decrease their growth rates in winter as they retreat into the sand and food becomes scarce as plankton becomes less productive (Jumars and Banse 1989). Long-lived clam populations are more susceptible to human-caused impacts than natural forces. The Northern Study Area supports large populations of clams on sand beaches, including species of recreational and commercial importance.

6.1.1.3 Rocky Subtidal

Rocky subtidal habitats in the Northern Study Area are not continuous, but occur in areas of bedrock outcroppings, seamounts, offshore islands, fragments of mid-ocean ridge, and rocky areas abandoned by rivers when sea levels were much lower (Garrison 1999). Rocky subtidal substrates at depths below about 15 to 20 m are characterized primarily by plants, such as coralline and red algae, that are able to tolerate reduced light levels (Dethier 1990). Benthic communities at these depths include sessile invertebrates, such as anemones, scallops, and barnacles. Gradually plant occurrence diminishes and the communities are dominated by bryozoans, solitary anemones (*Metridium*), and brachiopods (Dethier 1990). Motile invertebrates at these depths primarily include sea urchins (*Strongylocentrotus*).

Giant kelp (*Macrocystis pyrifera*) is the largest benthic organism known (Graham et al. 2007) and the predominant organism in shallower rocky subtidal areas within the Northern Study Area. Giant kelp ranges from Baja California to Alaska on the West Coast of North America but also occurs in South America, Australia, and South Africa (Abbott and Hollenberg 1976; Graham et al. 2007). Bull kelp (*Nereocystis luetkeana*), which ranges from Alaska to San Luis Obispo, California (Abbott and Hollenberg 1976), provides similar functions in certain areas within the Northern Study Area. Kelp forests grow to depths of 10 to 20 meters, with their holdfasts cemented onto rocks, while their stalks and fronds grow upward into the upper photic zone. Giant kelp canopies reduce the amount of light that reaches benthic substrates, inhibiting the development of understory algal communities and indirectly enhancing the occurrence of sessile invertebrates (Arkema et al. 2009). The understory of kelp forests provides additional structure to the rocky subtidal habitat, allowing concentrations of organisms not present in nearby rocky areas (Druehl 2001). In particular, sea urchins (*Strongylocentrotus* spp.) congregate around kelp

holdfasts and stalks for shelter and food. Sea urchins are effective grazers of kelp and will attract sea otters if the animals are present in the area. The kelp canopy provides a different habitat for pelagic organisms, including many species of larval fish. [Chapter 7.7](#) offers further detail on kelp forests.

Kelp sporophytes provide energy and create habitat structure that forms the basis of a highly productive ecosystem. Giant kelp plants modify their habitat by stabilizing rock or cobble substrates, changing sediment transport processes, extracting nutrients from the water, and reducing water motion (Graham et al. 2007). Kelp plants attach to the bottom with complex holdfasts that provide suitable habitat for many macrofaunal invertebrates and small fish. These plants also contribute directly to subtidal food webs primarily via detrital pathways. Storms and other disturbances shred tissue from the plants that are then captured by sea urchins (*Strongylocentrotus purpuratus* or *S. franciscanus*) or abalones (*Haliotis* spp.). Smaller invertebrates, including grazers and filter feeders, can consume very tiny pieces of kelp. Kelp are subject to impacts from human activities, particularly changes in nutrient loads and increases in temperature (Graham et al. 2007).

6.1.1.4 Sandy and Other Soft-Bottom Subtidal

The sediment particles that make up soft-bottom habitats range from clay to fine muds to silt and coarse sands. The habitat at any subtidal location is related to the energy of the overlying water. Most subtidal soft-bottom habitats are mud and silt; sandy soft bottoms are fairly rare in the Northern Study Area. Mud and silt subtidal habitats support benthic assemblages dominated by infaunal polychaetes, clams, and burrowing crustaceans along with some large epifauna such as sea cucumbers. Sandy subtidal benthic assemblages include a variety of infaunal and epifaunal mollusks, sea pens, sea whips, crabs, shrimp, and sea cucumbers.

Several physical factors are often thought to control benthic community structure. A thorough review of many benthic community studies by Snelgrove and Butman (1994), however, showed that the relationship between physical factors and benthic communities is correlative, not causal. The sediment grain-size distribution is most often cited as the determining factor in the distribution of infaunal organisms. Sediment data are correlated with infaunal community parameters to try to establish relationships between them. Snelgrove and Butman (1994) found little evidence supporting the idea that sediment grain size alone was a causative factor in determining species distributions. One explanation is that the method used to determine grain size dissociates the fabric of the sediment such that the sample probably resembles that encountered by infaunal animals. The organic content of the sediment is more likely to contribute patterns of animal distributions than grain size because of its potential role as a food source for deposit-feeding organisms (Snelgrove and Butman 1994); it also may be indicative of habitat that is potentially stressed (Hyland et al. 2005).

Crustaceans, such as Dungeness and red rock crab, live on coarse sandy sediment offshore along most of the Northern Study Area (Iribarne et al. 1995). These species breed off the coast, distributing their planktonic larvae by ocean current. Young crab instars move into the estuaries and nearshore areas to rear, preferring habitats with structures such as oyster beds for protection, but also sandy subtidal habitats where no structures occur (Iribarne et al. 1995).

6.1.2 Deep Benthic Habitats and Assemblages

There are no clear-cut definitions of shallow and deep water; in this document the distinction is made at the depth at which light no longer penetrates to the sea floor. Because light does not reach the bottom, the biological environment in the deep sea differs considerably from that in shallow waters. At about 1000 m, the physical environment of the deep sea becomes homogeneous; the region between 100 m and 200 m marks the transition between surface and deep waters (Carney 2001). Soft sediments comprise most of the sea floor in the deep sea and most deep-sea animals are well suited to living in and on them (Carney 2001; Gage 2001)

Pressure rises in this transition zone and waters become dark, low in dissolved oxygen, and progressively colder. Deep-sea water temperatures range from about 10°C at 200-m depth to about 2°C at depths greater than 3000 m (Carney 2001). Increased pressure inhibits many enzymatic reactions (Somero 1998) such that the enzyme systems of shallow-water and deep-sea organisms differ. Therefore, studies of the effects of various stressors on shallow-water organisms, including laboratory toxicity studies, probably are not applicable to deep-sea organisms. The deep sea is dark, although many deep-sea organisms can detect and are attracted to light (Carney 2001). Bioluminescence may be very important to organisms at depths greater than 1000 m. Activities that change the optical properties of the water, such as increased turbidity during pipeline placement, may affect deep-sea organisms. The concentration of dissolved oxygen in the water reaches a minimum at depths that vary among the oceans (Carney 2001). Any anthropogenic perturbation within this oxygen minimum zone that increases biological oxygen demand should be minimized (Carney 2001).

An important feature of the deep sea is the benthic boundary layer (BBL), which limits contact between the water column above and the benthic substrate below (Carney 2001). Water flow gradually decreases in the BBL as distance to the surface of the benthic substrate decreases. The BBL typically is thin where the bottom topography is flat and thick where the topography becomes complex (Kontar and Sokov 1997). The link between the BBL and the sea floor is strong, forming a unified system that should be studied as a single entity Carney (2001).

6.1.2.1 Rocky Substrate Assemblages

Rocky subtidal habitats in the Northern Study Area are not continuous, but occur in areas of bedrock outcroppings, seamounts, offshore islands, fragments of mid-ocean ridge, and rocky areas abandoned by rivers when sea levels were much lower (Garrison 1999). Some of the most extensive rocky subtidal habitat occurs in offshore reefs such as Orford Reef in Oregon (Miller et al. 2007) or within the boundaries of the National Marine Sanctuaries of Cordell Banks and the Gulf of the Farallones. These deeper rocky habitats attract benthic assemblages dominated by anemones such as *Metridium* spp., mollusks including many species of gastropods, and Pacific octopus. Because these habitats are generally below the photic zone, the food web is dominated by the rain of plankton and detritus from the overlying waters. In areas of high productivity (such as the upwelling zones), there is ample food to support a thriving benthic community. Other structures, such as shallow (less than 200 meters depth) offshore seamounts, often have lower levels of imported organic matter, resulting in lower benthic biomass (Garrison 1999).

Studies of Davidson Seamount off Monterey Bay may offer insights into hard substrates on seamounts and other areas within the Northern Study Area. Davidson Seamount rises 2400 m off the sea floor with the uppermost areas still 1200 m below the water surface. Seamounts are isolated areas often thought to have endemic faunas partly because the waters above them have recirculating current flows (Taylor caps or columns) that help retain larvae (Parker and Tunnicliffe 1994; McClain et al. 2009). This notion has been challenged by indications that the faunas may be widely distributed (McClain et al. 2009). Only about 7 percent of the 168 species identified at Davidson Seamount are possibly endemic (McClain et al. 2009). Most of the species (88 percent) also occur in non-seamount habitats. About half the species have geographic ranges that extend more than 1500 km. The predominant faunal groups on the seamount are deepwater corals, sponges, and echinoderms.

Although Davidson Seamount may provide clues about the faunas inhabiting deeper seamounts in the Northern Study Area, Cobb Seamount (about 510 km west of Oregon) is relatively shallow and supports many taxa in shallow coastal waters (Parker and Tunnicliffe 1994). The shallowest surfaces on the seamount are inhabited by fleshy brown algae (*Desmarestia*), coralline algae (*Lithothamnium*), and rock scallops (*Crassodoma gigantea*). The scallops provide substrate for many sea anemones, sponges, bryozoans, and tunicates. Sea urchins (*Strongylocentrotus franciscanus*) are common. In deeper waters, echinoderms such as crinoids, brittle stars, and predatory sea stars, such as *Pycnopodia*, predominate. Analyses of historical accounts, such as Birkeland (1971), show relatively little change in the fauna over a 20-year period (Parker and Tunnicliffe 1994).

Heceta Bank is a large rocky bank located about 40 to 50 km off the Oregon coast. The bank is about 30 nm long and 10 nm wide and extends in a north-south direction (Wakefield and Tissot 2007). Water depths at the bank range from 70 to 205 m. Several fisheries, including demersal trawling, historically occurred around the bank (Tissot et al. 2008). NMFS designated the bank as essential fish habitat in 2006, which closed the bank to bottom trawling (FR 2006). The bank is comprised of four main habitat types, each with a characteristic fauna, along an increasing depth gradient (Tissot et al. 2007). The shallowest habitat (<100 m deep) is rock ridge and boulders with yelloweye rockfish, lingcod, and basket stars predominant. Slightly deeper habitats (100 to 150 m deep) are small boulders and cobbles and house several rockfish species, brittle stars, and crinoids. The third zone is deep cobble (150 to 200 m deep) and provides habitat for rockfish, crinoids, and brittle stars. The deepest zone (> 200 m deep) marks a transition from rocky habitats to a muddy slope characterized by sea urchins (*Allocentrotus fragilis*), sea cucumbers (*Parastichopus* sp.), flatfish, and shortspine thornyhead (*Sebastolobus alascanus*).

Recently there has been heightened interest in deepwater coral communities in U.S. waters, with a focus on taxa that contribute to complex, three-dimensional habitat structure (Hourigan et al. 2007). Corals belong to either the Class Anthozoa and the Hydrozoa, which include the familiar sea anemones and hydroids, respectively. About 100 species of corals are now known to occur in the waters off the U.S. Pacific Coast (Whitmire and Clarke 2007), with the sea pens (Pennatulacea) being the most commonly occurring and most abundant group. Sea pens provide habitat for some fish species, but are not considered a major structural habitat type. Important

habitat structure builders in the region include the stony coral *Lophelia pertusa*, the black coral *Antipathes* spp., and the gorgonians *Paragorgia arborea* and *Primnoa pacifica* (Whitmire and Clarke 2007). *Lophelia* is fairly well known off Southern California but has recently been identified within the Northern Study Area. A significant area of *Lophelia* colonies that extended tens of meters and were up to 1 m high was discovered at depths of about 250 to 270 m in the Olympic Coast National Marine Sanctuary (Whitmire and Clarke 2007). *Lophelia* provides important habitat for invertebrates and fish that have yet to be characterized. Black corals (Order Antipatharia) occur primarily north of Cape Mendocino and are most abundant in waters off northern Oregon (Whitmire and Clarke 2007). Black corals may be long-lived and reach heights of more than 30 cm. They provide habitat for several invertebrate taxa, including echinoderms and crustaceans. Gorgonians (Order Gorgonacea) include more species than any other coral group in the region. Some species are very abundant, particularly north of Cape Mendocino, and form large stands along the bottom. Several species of rockfish and other fish often occur near gorgonians. Colonies of *Primnoa pacifica* and other species were found during recent surveys within the Olympic Coast National Marine Sanctuary (Whitmire and Clarke 2007).

Other major deep rocky substrates within the Northern Study Area, other than seamounts, are the chimneys, hydrothermal vents, and other outcroppings associated with the edge of the Juan de Fuca plate (Parker and Tunnicliffe 1994), approximately 450 km off the coast of Washington and Oregon. The open-ocean productivity at that distance from shore does not support a sizable benthic community. Autotrophic marine organisms provide a base for a deep benthic food in this location, as described in [section 6.1.2.3](#) of this chapter.

6.1.2.2 Soft Sediment Assemblages

Most of the energy used by deep-sea animals is derived from organisms in the photic zone, often thousands of meters above the sea floor. Exceptions occur, such as hydrothermal vent and cold-seep communities, where chemoautotrophs supply the energy ([discussed in section 6.1.2.3](#)). Food availability in the deep sea is often low and not supplied continuously. The soft sediments below 200 m depth support an array of meiofauna and microfauna; few macrofauna exist below this depth as their energy needs are too great (Parker and Tunnicliffe 1994). Most commonly, the meiofauna are dominated by polychaete worms living in tubes and burrows, and a rich matrix of marine bacteria and protists living in the interstitial spaces between the grains. A very limited number of scavengers, including several genera of crustaceans, have been identified from the deep sea. “Monster cameras” with bright lights were used in the 1960s to attract crabs and shrimp to soft sediments (Hardy et al. 2002). Subsequent analyses showed that the scavengers came from many kilometers away at the prospect of a meal.

Zimmerman (2006) analyzed fish and invertebrate data from three NMFS bottom-trawl surveys conducted in 1994, 1998, and 2001 at depths of 55 to 500 m along the U.S. West Coast from Southern California north to Vancouver Island, Canada. The predominant invertebrates collected included sea pens and sea whips (Pennatulacea), sea mouse (polychaete worms in the Family Aphroditidae), ocean shrimp (*Pandalus jordani*), Pacific glass shrimp (*Pasiphaea pacifica*), Dungeness crabs (*Cancer magister*), box crabs (*Lopholithodes foraminatus*), unidentified mollusks (nudibranchs, octopus), basket starfish (*Gorgonocephalus eucnemis*), and heart urchins (*Brisaster*). Sea whips and basket starfish formed the most consistent invertebrate

group, as defined by cluster analysis of taxa; however, they could not be linked to any particular fish group. Cluster analyses based on stations identified three depth groups: shallow (55-183 m); middle (184-366 m); and deep (367-500 m). Pacific glass shrimp and heart urchins consistently occurred (>50 percent of abundance) in the deep-station group. Ocean shrimp, sea mouse, and box crabs consistently occurred in the middle-station group. Dungeness crabs, mollusks, basket starfish, and sea whips consistently occurred in the shallow-station group.

The periodic influx of food from the surface waters contributes to a type of seasonality in the deep sea that was previously not thought to exist (Gooday 2002). Material sinking from the surface water forms aggregates, known as phytodetritus, which accumulate on the sea floor. Microplanktonic organisms, including diatoms, radiolarians, bacteria, and zooplankton fecal pellets constitute the bulk of the phytodetritus (Beaulieu and Smith 1998). Phytodetritus deposits fall on the sea floor in late spring or early summer and gradually disappear during the summer (Gooday 2002). Benthic microfauna (bacteria, protozoans) respond fairly rapidly to this influx of phytodetritus (Gooday 2002). Responses by meiofauna and macrofauna have been harder to document because both groups have longer generation times. Population changes of photic-zone organisms could affect the deep-sea benthos that depend on food from surface waters. This dependency renders the deep-sea benthos susceptible to climate changes that alter surface-water plankton communities. A 16-year time series in abyssal northeast Pacific has shown that climate-driven changes in food supply were linked to changes in megafauna abundance, phyla composition, and rank-abundance distributions (Ruhl and Smith 2004, Smith et al. 2006; Ruhl 2008). Macrofauna samples collected over the first 10 years also show the same types of correlations. Climate variations reflected in the Northern Oscillation Index were typically followed by shifts in food availability at the seafloor after about six months with subsequent changes in the macrofauna density after about four months (Ruhl et al. 2008) and after 6-12 months for megafauna (Ruhl and Smith 2004).

6.1.2.3 Chemosynthetic Communities

In the late 1970s, the first complex ecosystem that relied on primary production by chemoautotrophic micro-organisms was discovered in the deep sea near the Galapagos Islands (Van Dover 2002). Chemoautotrophic micro-organisms are able to remove energy from reduced inorganic compounds and are consumed by a variety of invertebrates. These ecosystems, characterized by geothermally heated water, are located along active mid-ocean ridges and back-arc spreading centers in all major ocean basins, including the Gorda, Juan de Fuca, and Explorer Ridges in the northeast Pacific (Van Dover 2003). The hydrothermal vent system along the Juan de Fuca Ridge system may be the best known in the northeast Pacific. The ridge is about 450 km off the coast of North America, ranging from southern British Columbia to central Oregon (Kelly et al. 2007). Tsurumi and Tunnicliffe (2001) documented changes in the benthic community along part of the Juan de Fuca Ridge following an eruption in 1986. Recolonization occurred rapidly with about half the known species pool for the system present within two years of the eruption. The superheated water leaking from the hydrothermal vents and chimney systems nourishes a rich soup of archae and bacteria, which forms the base of a chemotrophic food web that supports crustaceans, bivalve mollusks, and polychaete worms (Deming and Baross 1993). The growth rates of these benthic invertebrates are extremely fast and the productivity is quite high, even by standards of coastal and estuarine populations (Deming and Baross 1993). Yet,

these communities die very quickly once a vent or chimney is sealed off and no longer discharges superheated mineral-rich water.

Two other types of ecosystems provide chemosynthetic energy to the deep sea: cold seeps and whale falls. Cold seeps occur where chemically dependent organisms derive energy from methane hydrates, sediment pore water, and hydrocarbon reservoirs (Sibuet and Olu 1998). Cold seep communities within the Northern Study Area occur off Eureka, California (Kennicutt et al. 1989) and the Hydrate Ridge on the Cascadia convergent margin off Central Oregon (Sahling et al. 2002). The chemosynthetic communities at Hydrate Ridge covered an area of almost 500 m², although the seeps at the ridge may be more extensive (Leefman et al. 2008). The benthic invertebrate communities supported around cold seeps resemble those of hydrothermal vents, with polychaete worms representing the greatest biomass.

Whale falls—the carcasses of whales that land on the deep-sea floor—represent major, although highly scattered and localized (about 50 m² area), sources of carbon and may house distinct chemoautotrophic communities (Smith and Baco 2003). Whale falls have been studied primarily in Southern California waters, but certainly can occur anywhere whales travel. Whale falls may provide an important link to vent and seep communities by providing “stepping stones” that aid in the dispersal of vent clams and other species (Smith et al. 2008). Whales and large particles that reach the deep sea play host to a succession of benthic assemblages. Assisted initially by large fish and sharks, the whale carcass is breached and waves of polychaetes, mollusks, and crustaceans feed voraciously. After the whale meat is removed, assemblages of protists and bacteria thrive on removing all organic matter from the bones (Treude et al. 2009).

6.2 COMMERCIAL AND RECREATIONALLY IMPORTANT SPECIES

The Pismo clam and the Pacific razor clam support important commercial and recreational fisheries in the Northern Study Area. The Pismo clam, *Tivela stultorum*, occurs from Half Moon Bay, California to Mexico (McLachlan et al. 1996). Coan et al. (2000) list the northernmost occurrence in California as Stinson Beach. Pismo clams live from intertidal areas to depths of about 25 m. These clams occasionally may constitute the predominant macrofauna on a beach. Pismo clams provide a vital link in the sand beach food web, transferring primary production in the surf zone to predators that include crabs, moon snails, fish, sea gulls, and sea otters (McLachlan et al. 1996). These clams were heavily fished commercially in California from 1916 to 1947 when the fishery closed (McLachlan et al. 1996). Recreational fishing for Pismo clams continues in California, but the quantity harvested is not known.

The Pacific razor clam (*Siliqua patula*) ranges from Cook Inlet, Alaska to Morro Bay, California, occurring to depths of 55 m (Coan et al. 2000). Razor clams live on broad flat beaches where the sand is fine and hard-packed (McLachlan et al. 1996). Similar to Pismo clams, razor clams link surf zone production to upper trophic levels. Commercial harvest of razor clams occurs in the northern parts of the species' range, but not in California. The recreational fishery, however, is more important than the commercial fishery in Oregon and Washington (McLachlan et al. 1996).

Other commercially and recreationally important species include Dungeness crab, various abalone species, ocean shrimp, sea cucumbers, and sea urchins. Dungeness crab is by far the

most commercially valuable invertebrate species with more than \$120 million in commercial landings in 2007 in Washington, Oregon, and California combined (including areas outside the Northern Study Area). [Table 6.1](#) lists a selection of commercially valuable species by State. The data comes from NOAA Fisheries Annual Commercial Landings Statistics online database (USDOC, NOAA Fisheries 2007).

Table 6.1.

A Selection of Invertebrate Commercial Landings, in WA, OR, and CA. NOAA Fisheries Annual Commercial Landings Statistics 2007

State (statewide)	Target Fishery	Pounds	Value in Dollars
California	Dungeness crab	11,024,395	26,892,210
	Red rock crab	1,282,269	1,640,685
	Mollusks	67,299	206,213
	Sea cucumber	486,063	665,752
	Sea urchins	11,131,171	5,400,279
	Ocean shrimp	636,944	301,705
	Pacific rock shrimp	277,747	553,684
	Spot shrimp	258,684	2,879,716
Oregon	Abalone species	1,432	5,813
	Clam, butter	8,438	7,093
	Clam, Pacific razor	11,969	62,116
	Cockle, nuttall	53,849	71,700
	Crab, Dungeness	17,000,088	38,201,829
	Oyster, Pacific	196,543	1,847,020
	Sea urchins	430,754	159,404
	Shrimp, ocean	19,989,798	9,364,754
Washington	Clam, butter	8,873	10,961
	Clam, Manila	1,337,273	21,597,838
	Clam, Pacific geoduck*	2,202,359	28,737,752
	Clam, softshell	225,651	179,280
	Crab, Dungeness	22,487,459	54,317,389
	Mussel, blue*	474,554	3,819,966
	Oyster, Pacific	11,271,831	33,738,215
	Sea cucumbers	459,271	751,124
	Sea urchins	459,359	367,817
	Shrimp, ocean	3,890,847	1,753,412
	Shrimp, penaeid	381,634	1,771,747
Total		106,056,554	208,413,264
	*Almost entirely harvested north of Northern Study Area		
	http://www.st.nmfs.noaa.gov/st1//commercial/landings/annual_landings.html		

Commercial landings of invertebrates in the Northern Study Area have remained relatively stable over the past several decades with two exceptions. Dungeness crab landings have increased steadily as salmon fisheries have declined. From 1990 to 2007, the average landings of these crabs for the Northern Study Area increased from 14,481 mT in 1990, to 16,074 mT in 2000, and 22,913 mT in 2007 (USDOC, NOAA Fisheries 2007). Fisheries for abalone have been severely curtailed in recent years. As several species of abalone have been listed under the Endangered Species Act ([see section 6.3](#) for more detail), commercial fisheries have ceased in Washington and California, and only a small fishery remains in Oregon. Recreational fisheries for abalone in California and Oregon remain small, while all abalone take is prohibited in Washington (USDOC, NOAA Fisheries 2007).

6.3 THREATENED AND ENDANGERED SPECIES

Only two West Coast marine invertebrates—black abalone (*Haliotis cracherodii*) and white abalone (*Haliotis sorenseni*)—are listed as threatened and endangered under the Endangered Species Act, falling under NOAA Fisheries’ jurisdiction. The northernmost occurrence of the black abalone, based on museum specimens, is Crescent City, California, although the current range extends from Point Arena, California to northern Baja, California (VanBlaricom et al. 2009). There are unconfirmed reports of the species in Coos Bay, Oregon. The northernmost occurrence for the white abalone is Point Conception (USDOC, NMFS 2008), which is not part of the Northern Study Area. Three abalone species are listed as Federal Species of Concern, a rank that has no formal standing but indicates concern over the status of the species with insufficient information to make a more formal designation. Of the three species, only the pinto abalone (*Haliotis kamtschatkana*) overlaps with the Northern Study Area (USDOC, NMFS 2007a). Pinto abalones range from Sitka, Alaska to Point Conception, California where they live in kelp beds along exposed coasts at water depths ranging from about 30 to 100 m (USDOC, NMFS 2007a). The species has declined due to overharvesting, illegal harvesting, and possibly sea otter predation. The green abalone (*Haliotis fulgens*) and the pink abalone (*Haliotis corrugata*) do not occur in the Northern Study Area (USDOC, NMFS 2007b, c).

6.4 SUMMARY AND DATA GAPS

The Northern Study Area contains a diversity of benthic habitats and assemblages with geographic differences determined by factors such as wave action, currents, depth, temperature, and sediment grain size. Fundamental differences exist between shallow and deep (>200 m) benthic ecosystems and organisms. As water depth increases, pressure also increases while dissolved oxygen, temperature, and light all decrease, dictating differences in enzymatic processes and life strategies. The deep benthos is linked to processes in the photic zone through the flux of detritus produced by primary and secondary producers.

Many of the benthic communities, particularly those on sandy beaches and in deeper waters, in the areas that may be directly affected by the installation and operation of renewable energy devices on the OCS are not well characterized. Baseline monitoring of benthic communities is needed to document their present condition; however, studies of species diversity and abundance are necessary throughout the life of any offshore project. As more is learned about biophysical coupling on the Northern Study Area continental shelf (Hickey and Banas 2008) observations of

upwelling, vertical mixing, nutrient fluxes and benthic assemblages could be used to determine alterations in the ecosystem. As affected state, regional, and local agencies create adaptation strategies to climate change, additional information on habitat migration and migration corridors will be required.

6.5 LIST OF LITERATURE CITED—BENTHOS

- 71 FR 27408. May 11 2006. Magnuson-Stevens Act Provisions; Fisheries off West Coast States; Pacific Coast Groundfish Fishery. *Federal Register*. U.S. Dept. of Commerce.
- Abbott, I.A. and G.J. Hollenberg. 1976. *Marine Algae of California*. Stanford University Press. Stanford, California. 827 pp.
- Adams, N.G., M. Lesoing and V.L. Trainer. 2000. Environmental conditions associated with Domoic acid in Razor clams on the Washington Coast. *Journal of Shellfish Research* 19(2):1007-1015.
- Arkema, K. K., D.C. Reed and S.C. Schroeter. 2009. Direct and Indirect Effects of Giant Kelp Determine Benthic Community Structure and Dynamics. *Ecology* 90(11):3126-3137.
- Beaulieu, S.E. and K.L. Smith. 1998. *Phytodetritus* entering the benthic boundary layer and aggregated on the sea floor in the abyssal NE Pacific: Macro- and microscopic composition. *Deep-Sea Research Part II-Topical Studies in Oceanography* 45(4-5):781-+.
- Birkeland, C. 1971. Biological observations on Cobb Seamount. *Northwest Science* 45:193-199.
- Carney, RS. 2001. Management applicability of contemporary deep-sea ecology and reevaluation of Gulf of Mexico studies, Final Report. New Orleans, LA. Pp 174.
- Coan, E.V., P.V. Scott and F.R. Bernard. 2000. *Bivalve seashells of western North America*. Santa Barbara Museum of Natural History. 764 pp.
- Connolly, S.R. and J. Roughgarden. 1998. A latitudinal gradient in northeast Pacific intertidal community structure: Evidence for an oceanographically based synthesis of marine community theory. *American Naturalist* 151:311-326.
- Deming, J.W. and J.A. Baross. 1993. Deep-sea smokers: Windows to a subsurface biosphere? *Geochimica et Cosmochimica Acta* 57(14):3219-3230.
- Denny, M.W. and R.T. Paine. 1998. Celestial mechanics, sea-level changes, and intertidal ecology. *Biological Bulletin* 194:108-115.
- Dethier, M.N. 1990. *A Marine and Estuarine Habitat Classification System for Washington State*. Washington Natural Heritage Program, Dept. of Natural Resources Olympia, Washington. 56 pp.
- Druehl, L. 2001. *Pacific Seaweeds*. Harbour Publishing, Madeira Park, BC. 192 pp.

- Gage, J.D. 2001. Deep-sea benthic community and environmental impact assessment at the Atlantic Frontier. *Continental Shelf Research* 21(8-10):957-986.
- Garrison, T. 1999. *Oceanography: An invitation to marine science*. Belmont, CA: Wadsworth.
- Gooday, A.J. 2002. Biological responses to seasonally varying fluxes of organic matter to the ocean floor: A review. *Journal of Oceanography* 58(2):305-332.
- Graham, M.H., J.A. Vasquez and A.H. Buschmann. 2007. Global ecology of the Giant kelp *Macrocystis*: From ecotypes to ecosystems. *Oceanography and Marine Biology* 45, 39-88.
- Hardy, K., M. Olssod, A.A. Yayanos, J.Prshaz and W. Hagey. 2002. Deep ocean visualization experimenter (DOVE): Low-cost 10km camera and instrument platform. IEEE Explore.
- Hickey, B.M. and N.S. Banas. 2008. Why is the Northern End of the California Current System So Productive? *Oceanography* 21(4):90-107.
- Hourigan, T.F., S.E. Lumsden, G. Dorr, A.W. Bruckner, S. Brooke and R.P. Stone. 2007. State of Deep Coral Ecosystems of the United States: Introduction and National Overview. In: Lumsden SE, Hourigan TF, Bruckner AW, Dorr G (eds.). *The State of Deep Coral Ecosystems of the United States*. U.S. Dept. of Commerce, NOAA Technical Memorandum CRCP-3. Silver Spring, Maryland.
- Hyland, J., L. Balthis, I. Karakassis, P. Magni, A. Petrov, J. Shine, O. Vestergaard and R. Warwick. 2005. Organic carbon content of sediments as an indicator of stress in the marine benthos. *Ecology-Progress Series* 295:91-103.
- Iribarne, O., D. Armstrong and M. Fernández. 1995. Environmental impact of intertidal juvenile Dungeness crab habitat enhancement: Effects on bivalves and crab foraging rate. *Journal of Experimental Marine Biology and Ecology* 192(2):173-194.
- Jumars, P.A. and K. Banse. 1989. Benthos and its interaction with bottom boundary layer processes. *Coastal Oceanography of Washington and Oregon*. M.R. Landry and B.M. Hickey. Amsterdam, Elsevier. Pp 349-365.
- Kelly, N., A. Metaxas, and D. Butterfield. 2007. Spatial and temporal patterns of colonization by deep-sea hydrothermal vent invertebrates on the Juan De Fuca Ridge, NE Pacific. *Aquatic Biology* 1(1):1-16.
- Kennedy, A.D. and C.A. Jacoby. 1999. Biological indicators of marine environmental health: *Meiofauna*—A neglected benthic component? *Environmental Monitoring and Assessment* 54(1):1573-2959.
- Kennicutt, M.C., J.M. Brooks, R.R. Bidigare, S.J. McDonald and D.L. Adkison. 1989. An upper slope “cold” seep community: Northern California. *Limnology and Oceanography* 34:(3):635-640.

- Kontar, E.A. and A.V. Sokov. 1997. On the benthic boundary layer's dynamics. *Journal of Marine Systems* 11(3-4):369-385.
- Leefmann, T., J. Bauermeister, A. Kronz, V. Liebetrau, J. Reitner and V. Thiel. 2008. Miniaturized biosignature analysis reveals implications for the formation of cold seep carbonates at Hydrate Ridge (off Oregon, USA). *Biogeosciences* 5(3):731-738.
- McClain, C.R., L. Lundsten, M. Ream, J. Barry and A. Devogelaere. 2009. Endemicity, Biogeography, Composition, and Community Structure on a Northeast Pacific Seamount. *Seamount Biogeography* 4(1):e4141.
- McLachlan, A., J.E. Dugan, O. Defeo, A.D. Ansell, D.M. Hubbard, E. Jaramillo and P.E. Pechaszadeh. 1996. Beach clam fisheries. *Oceanography and Marine Biology* 34:163-232.
- Menge, B.A. 2000. Top-down and bottom-up community regulation in marine rocky intertidal habitats. *Journal of Experimental Marine Biology and Ecology* 250(1-2):257-289.
- Miller, B., A. Merems and H. Weeks. 2007. Pilot visual survey of Orford Reed, Oregon. Coastal Zone 07, Portland OR.
- Minchinton, T.E. and R.E. Scheibling. 1993. Free space availability and larval substratum selection as determinants of barnacle population structure in a developing rocky intertidal community. *Marine Ecology Progress Series* 95:233-244.
- Oceanographic Institute of Washington and Human Resources Planning Institute. 1977. A summary of knowledge of the Oregon and Washington coastal zone and offshore areas. Springfield, VA: U.S. Dept. of Commerce, National Technical Information Service.
- Paine, R.T. 1974. Intertidal community structure: experimental studies on the relationship between a dominant competitor and its principal predator. *Oecologia* 15:93-120.
- Parker, T. and V. Tunnicliffe. 1994. Dispersal strategies of the biota on an oceanic seamount—Implications for ecology and biogeography. *Biological Bulletin* 187(3):336-345.
- Petes, L.E., B.A. Menge, and A.L. Harris. 2008. Intertidal mussels exhibit energetic trade-offs between reproduction and stress resistance. *Ecological Monographs* 78:387-402.
- Ricketts, E.F., J. Calvin, and J.W. Hedgepeth. 1985. *Between Pacific tides*. Stanford University Press. P. 652.
- Ruhl, H.A. 2008. Community Changes in the Variable Resource Habitat of the Abyssal Northeast Pacific. *Ecology* 89(4): 991-1000.
- Ruhl, H.A., and K.L. Smith. 2004. Shifts in Deep-Sea Community Structure Linked to Climate and Food Supply. *Science* 305:513-515.

- Ruhl, H.A., J.A. Ellena and K.L. Smith. 2008. Connections between climate, food limitation, and carbon cycling in Abyssal sediment communities. In: Proceedings of the National Academy of Sciences of the United States of America 105(44):17006-17011.
- Sahling, H., D. Rickert, R.W. Lee, P. Linke and E. Suess. 2002. Macrofaunal community structure and sulfide flux at gas hydrate deposits from the Cascadia convergent margin, NE Pacific. *Marine Ecology-Progress Series* 231:121-138.
- Schoch, G.C., B.A. Menge, G. Allison, M. Kavanaugh, S.A. Thompson and S.A. Wood. 2006. Fifteen degrees of separation: Latitudinal gradients of rocky intertidal biota along the California Current. *Limnology and Oceanography* 51(6):2564-2585.
- Sibuet, M. and K. Olu. 1998. Biogeography, biodiversity and fluid dependence of deep-sea cold-seep communities at active and passive margins. *Deep-Sea Research Part II-Topical Studies in Oceanography* 45(1-3):517-567.
- Smith, C.R. and A.R. Baco. 2003. Ecology of whale falls at the deep-sea floor. *Oceanography and Marine Biology: an Annual Review* 41:311-354.
- Smith, K.L., Jr., R.J. Baldwin, H.A. Ruhl, M. Kahru, B.G. Mitchell and R.S. Kaufmann. 2006. *Limnology and Oceanography* 51(1):166-176.
- Smith, C. R., F.C. De Leo, A.F. Bernardino, A.K. Sweetman and P.M. Arbizu. 2008. Abyssal food limitation, ecosystem structure and climate change. *Trends in Ecology & Evolution* 23(9):518-528.
- Snelgrove, P.V.R. and C.A. Butman. 1994. Animal-sediment relationships revisited: Cause versus effect. *Oceanography and Marine Biology: An Annual Review* 32:111-177.
- Somero, G. 1998. Adaptations to the deep sea. *BioForum: Advances in Deep-Sea Biology*.
- Tissot, B.N., M.A. Hixon and D.L. Stein. 2007. Habitat-based submersible assessment of macro-invertebrate and groundfish assemblages at Heceta Bank, Oregon, from 1988 to 1990. *Journal of Experimental Marine Biology and Ecology* 352:50-64.
- Tissot, B.N., W.W. Wakefield, M.A. Hixon and J.E.R. Clemons. 2008. Twenty Years of Fish-Habitat Studies on Heceta Bank, Oregon. In: J.R. Reynolds and H.G. Greene (eds.). *Marine Habitat Mapping Technology for Alaska*. Alaska Sea Grant College Program, University of Alaska Fairbanks, doi:10.4027/mhmta.2008.15. Available at <http://seagrant.uaf.edu/bookstore/pubs/AK-SG-08-03.html>.
- Treude, T., C.R. Smith, F. Wenzhöfer, E. Carney, A.F. Bernardino, A.K. Hannides, M. Krüger and A. Boetius. 2009. Biogeochemistry of a deep-sea whale fall: Sulfate reduction, sulfide efflux and methanogenesis. *Marine Ecology-Progress Series* 382:1-21.

- Tsurumi, M. and V. Tunnicliffe. 2001. Characteristics of a hydrothermal vent assemblage on a volcanically active segment of Juan De Fuca Ridge, Northeast Pacific. *Canadian Journal of Fisheries and Aquatic Sciences* 58(3):530-542.
- U.S. Dept . of Commerce, National Marine Fisheries Service (NMFS). 2007a. Species of concern: Pinto abalone. Internet website: http://www.nmfs.noaa.gov/pr/pdfs/species/pintoabalone_detailed.pdf. Accessed May 11 2009.
- U.S. Dept. of Commerce, National Marine Fisheries Service (NMFS). 2007b. Species of concern: Green abalone. Internet website: http://www.nmfs.noaa.gov/pr/pdfs/species/greenabalone_detailed.pdf. Accessed May 11 2009.
- U.S. Dept. of Commerce, National Marine Fisheries Service (NMFS). 2007c. Species of concern: Pink abalone. Internet website: http://www.nmfs.noaa.gov/pr/pdfs/species/pinkabalone_detailed.pdf. Accessed May 11 2009.
- U.S. Dept. of Commerce, National Marine Fisheries Service (NMFS). 2008. Species of concern: White abalone. Internet website: <http://www.nmfs.noaa.gov/pr/species/invertebrates/whiteabalone.htm>. Accessed May 11 2009.
- U.S. Dept. of Commerce, NOAA Fisheries, Office of Science and Technology (NOAA). 2007. NOAA Fisheries annual commercial landing statistics for 2007. Internet website: http://www.st.nmfs.noaa.gov/st1/commercial/landings/annual_landings.html. Accessed May 27 2009.
- Van Dover, C.L. 2002. Community structure of Mussel beds at Deep-Sea hydrothermal vents. *Marine Ecology-Progress Series* 230:137-158.
- Van Dover, C.L. 2003. Variation in community structure within hydrothermal Vent mussel beds of the East Pacific Rise. *Marine Ecology-Progress Series* 253:55-66.
- VanBlaricom, G., M. Neuman, J. Butler, A. Devogelaere, R. Gustafson, C. Mobley, D. Richards, S. Rumsey and B. Taylor. 2009. Status review report for Black abalone (*Haliotis cracherodii*). Long Beach, California.
- Wakefield, W.W. and B.N. Tissot. 2007. Ecological associations between structure forming invertebrates and demersal fishes on Heceta Bank, Oregon. PICES 16th Annual Meeting: The changing North Pacific: Previous patterns, future projections, and ecosystem impacts. October 26 - November 5, 2007, Victoria, BC, Canada.
- Whitmire, C.E. and M.E. Clarke. 2007. State of Deep Coral Ecosystems of the U.S. Pacific Coast: California to Washington. In: Lumsden SE, Hourigan TF, Bruckner AW, Dorr G

(eds.). The State of Deep Coral Ecosystems of the United States. NOAA Technical Memorandum CRCP-3. Silver Spring, Maryland.

Zimmermann, M. 2006. Benthic fish and invertebrate assemblages within the National Marine Fisheries Service U.S. West Coast triennial bottom trawl survey. *Continental Shelf Research* 26(8):1005-1027.

7. FISH

7.1 ZOOGEOGRAPHY

The zoogeography of fish species in the Northern Study Area is defined by oceanographic processes and physical features such as the Columbia River, the California Current System, estuaries and bays, upwelling zones, banks, seamounts, and the Outer Continental Shelf (OCS) break. Point Conception, south of the study area, is a transition zone between warmer-water species to the south and colder-water species to the north (Horn et al. 2006; Tolimieri and Levin 2006). Because the Northern Study Area is above this line, species assemblages from north to south are fairly consistent throughout, with some regional variation. In general, there is more variation from north to south in shallow waters than in deeper waters (Tolimieri and Levin 2006). Certain abundant species in the Northern Study Area, such as Pacific hake (*Merluccius productus*), migrate between breeding grounds in warmer waters south of the study area and feeding grounds in Oregon, Washington, and points farther north (Bailey et al. 1982; Saunders 1997).

Major rivers in the Northern Study Area serve as habitat for spawning and juvenile salmonids and other species and also provide nutrients and sediment to ocean systems. In southern Washington and northern Oregon, the Columbia River and lower Columbia River estuary are important for migrating salmonid species, American shad (*Alosa sapidissima*), and white sturgeon (*Acipenser transmontanus*). Fish returning to the Columbia River to spawn or leaving the estuary at the start of their ocean life phase attract pelagic, avian, and marine mammal predators and are targeted by commercial, subsistence, and recreational fishers (Emmett et al. 2006). The Columbia River plume is a major oceanographic feature that brings buoyant freshwater to the OCS, along with sediment, micronutrients, carbon, and particulate organic matter that fuel productivity along the outer coast. In southern Oregon and Northern California, the Klamath, Elk, and Trinity Rivers all support evolutionarily significant units (ESU) of salmonid and steelhead species (USDOC, NMFS 2009b). An ESU is a population of organisms that is considered distinct for purposes of conservation. Tribal, commercial, and recreational fisheries have historically targeted salmonids that return to these rivers, but in recent years runs have been depressed. The Sacramento and San Joaquin Rivers both empty into the San Francisco Bay estuary. Because of collapsing Chinook salmon runs in the Sacramento and San Joaquin Rivers, the Pacific Fishery Management Council canceled the California commercial fishing season in both 2008 and 2009 (USDOC, NMFS 2009b).

Estuaries and bays in the Northern Study Area include Grays Harbor, Willapa Bay, the lower Columbia River estuary, Tillamook Bay, Siletz Bay, Yaquina Bay, Alsea Bay, Winchester Bay, Coos Bay, Humboldt Lagoon, Humboldt Bay, Tomales Bay, and the San Francisco Bay estuary. Estuaries and bays in the Northern Study Area provide important habitat for juvenile fish, such as English sole and adult species of sturgeon.

The California Current flows south off the western coast of North America from British Columbia to Baja, California. The California Current is up to 1,000 km wide (Garrison 1999) with diffuse and variable boundaries. This system brings cold northern waters south, usually

intersecting with the eastern Pacific Coast in southern Oregon. The California Current System (CCS) comprises the southward California Current, northward Southern California Countercurrent, Davidson Current, and California undercurrent (Hickey 1979). Jets and eddies in the CCS help extend cool, nutrient-rich, upwelled water from the nearshore to farther offshore. These features may be semipermanent: for example, the San Francisco Eddy northwest of Monterey Bay (Hickey 1979). The combination of the CCS and seasonal upwelling along the coast of the Northern Study Area fuels high productivity and rich pelagic fisheries. For more information on the circulation of the California Current System, [see Chapter 1 Physical Oceanography](#).

The El Niño Southern Oscillation (ENSO) and the Pacific Decadal Oscillation (PDO) affect upwelling, currents, and near-surface temperatures in the Northern Study Area. ENSO events occur roughly every three to eight years, causing weak upwelling and warm water to build off the coast of South America, which affects circulation, weather, productivity, and recruitment in the Northern Study Area (Garrison 1999). ENSO effects occur primarily in the tropics, with secondary effects occurring farther north. PDO cycles occur over a 20- to 30-year period, with primary effects in the northern Pacific and secondary effects in the tropics. “Warm” PDO regimes dominated from 1925 to 1946 and from 1977 to the mid-1990s. Warm PDO periods correspond to increased productivity in Alaska and inhibited productivity off the West Coast of the United States in the Northern Study Area; cold phases correspond to the opposite conditions (JISAO 2000). ENSO and PDO cycles impact the relative abundance and distribution of fish in the Northern Study Area (McClatchie et al. 2008). In a PDO warm cycle, salmonid species with life histories that include feeding off the Gulf of Alaska tend to thrive, while the opposite is true for those who feed more locally in the Northern Study Area. In an ENSO year, weak upwelling and warm temperatures can lead to low productivity, poor food availability, and low recruitment for fish species, with food chain effects extending to birds, marine mammals, and humans. Northward distributions of typically southern species may also occur (McClatchie et al. 2008).

7.1.1 Essential Fish Habitat

The 1996 amendments to the Magnuson-Stevens Fishery Conservation and Management Act (also known as the Sustainable Fisheries Act, hereafter “the Act”) (16 U.S.C. 1801 et seq.) established provisions for identifying and protecting habitat essential to the production of federally managed species. This so-called “essential fish habitat” (EFH) is broadly defined to include “those waters and substrates necessary to fish for spawning, breeding, feeding, or growth to maturity” (U.S.C. 1802(10)). Given the number of fish species managed along the Pacific Coast and their diverse life histories and habitat preferences, The National Oceanic and Atmospheric Administration’s National Marine Fisheries Service (USDOC, NMFS 2009b) has declared nearly all the marine environment along the Pacific Coast as EFH ([Figure 7.1](#)).

Marine fish depend on healthy habitats to survive and reproduce. Throughout their lives, fish in the Northern Study Area use many types of habitats, including seagrass, salt marsh, rocky intertidal areas, and hard (also called “live”) bottom areas. Various activities on land and in the water may threaten to alter, damage, or destroy these habitats, thereby affecting the fishery resources that use them. NMFS, regional fishery management councils, interstate marine fisheries commissions, and Federal and State agencies work together to address these threats by

identifying EFH for each federally managed fish species and developing conservation measures to protect and enhance those habitats. The Act requires Fishery Management Plans (FMPs) to include identification and description of EFH, descriptions of nonfishing and fishing threats, and suggested measures to conserve and enhance EFH.

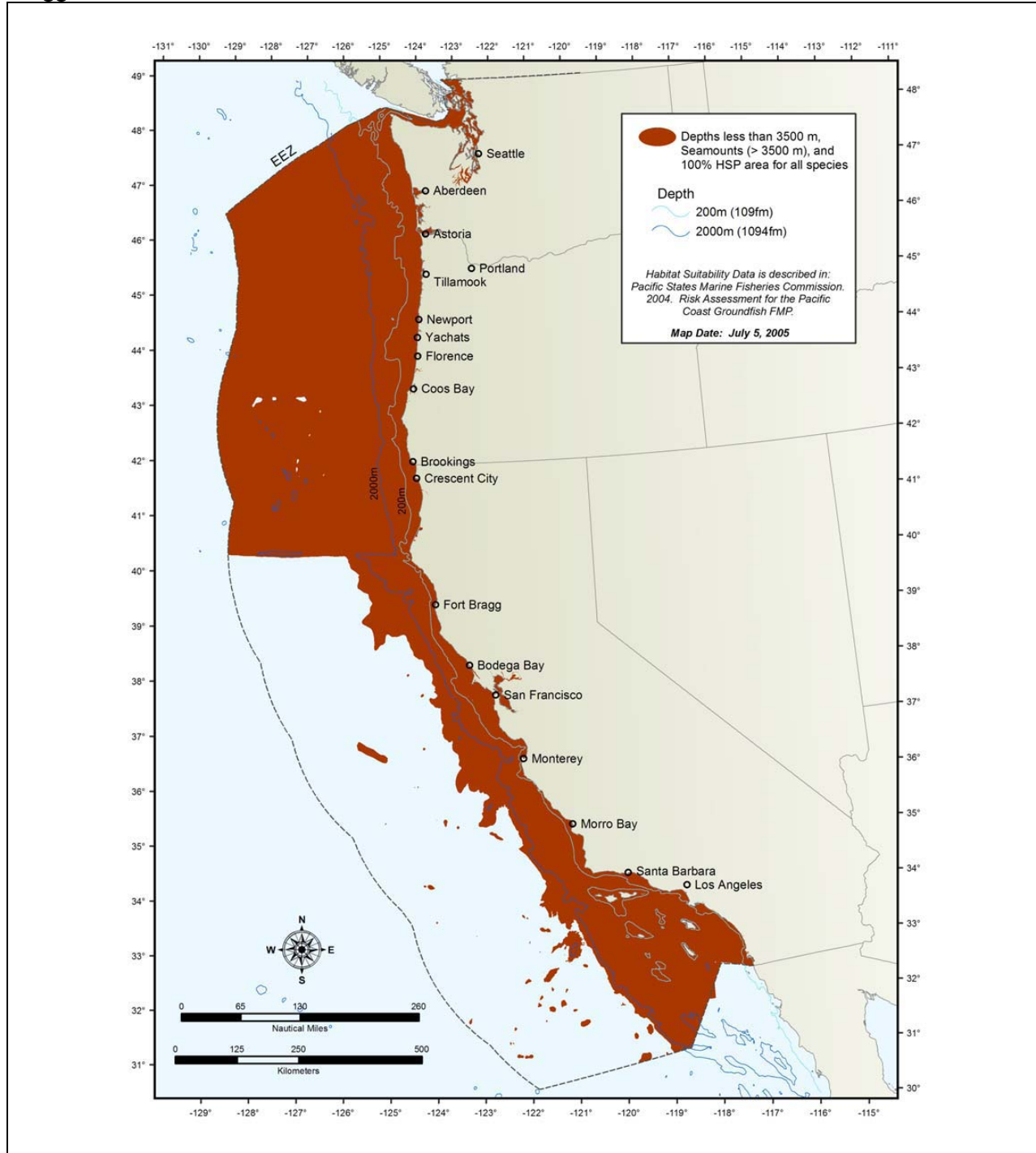

Figure 7.1. Designated groundfish essential fish habitat

Source: Pacific Fishery Management Council (2008)

The Pacific Fishery Management Council (PFMC) manages more than 100 species of fish under four Fishery Management Plans: (1) Coastal Pelagics Fishery Management Plan, (2) Pacific Salmon Fishery Management Plan, (3) Pacific Groundfish Fishery Management, and (4) Highly Migratory Species. Coastal pelagic species include northern anchovy, market squid, Pacific bonito, Pacific saury, Pacific herring, Pacific sardine, Pacific (chub or blue) mackerel, and jack (Spanish) mackerel. Under the groundfish plan, more than 64 species of rockfish (Scorpaenidae) are managed including widow, yellowtail, canary, shortbelly, vermilion, bocaccio, chilipepper, cowcod, yelloweye, thornyheads, scorpionfish, and Pacific ocean perch. The groundfish management plan also includes flatfish (sole, starry flounder, turbot, and sanddab); roundfish (lingcod, cabezon, kelp greenling, Pacific cod, Pacific hake, and sablefish); and sharks and skates (leopard shark, soupfin shark, spiny dogfish, big skate, California skate, and longnose skate). Highly migratory species include tunas (North Pacific albacore, yellowfin, bigeye, skipjack, and northern bluefin); sharks (common thresher, pelagic thresher, bigeye thresher, shortfin mako, and blue); billfish/swordfish (striped marlin, Pacific swordfish); and dolphinfish.

A determination of the EFH for coastal pelagic species is based on a specific temperature range that applies to all marine and estuary waters from the West Coast shoreline (and estuaries) to the limits of the exclusive economic zone (EEZ) (16 U.S.C. 1801 et seq.). In estuaries and marine areas, salmon habitat extends from the shoreline to the 200-mile limit of the EEZ and beyond. In freshwater, salmon EFH includes all the lakes, streams, ponds, rivers, wetlands, and other bodies of water that have been historically accessible to salmon. The description of salmon EFH also includes areas above artificial barriers, except for certain barriers and dams through which fish cannot pass. EFH for groundfish species is defined as all areas from the high-tide line (and parts of estuaries) to 3,500 meters (1,914 fathoms) in depth. Habitat areas of particular concern for groundfish species include estuaries, canopy kelp, seagrass, and rocky reefs. EFH for highly migratory species is defined by temperature ranges, salinity, oxygen levels, currents, shelf edges, and seamounts.

In addition to designating an EFH, NMFS requires fishery management councils to identify Habitat Areas of Particular Concern (HAPCs) within fishery management plans. HAPCs are discrete subsets of EFH that provide extremely important ecological functions or are especially vulnerable to degradation. Councils may designate a specific habitat area as an HAPC based on (1) importance of the ecological function provided by the habitat; (2) extent to which the habitat is sensitive to human-induced environmental degradation; (3) whether, and to what extent, development activities are, or will be, stressing the habitat type; or (4) rarity of the habitat type. While the HAPC designation does not confer additional protection for or restrictions on an area, it can help prioritize conservation efforts. Healthy populations of fish require not only the relatively small habitats identified as HAPCs, but also other areas that provide suitable habitat functions. Thus, HAPCs alone may not suffice in supporting the larger numbers of fish needed to maintain sustainable fisheries and a healthy ecosystem. A variety of general habitat types have been designated as HAPCs for fishery species in the Pacific Region, including estuaries, canopy kelp, seagrass, and rocky reef areas. In addition, a large number of specific areas of interest have also been designated as HAPCs. Examples include specific fishing banks or ledges, seamounts, marine sanctuaries, and fishery conservation areas.

7.1.2 Spawning Areas

Doyle et al. (1993) identified four general larval fish assemblages in the Northern Study Area thought to correspond with spawning strategies. These include “a coastal assemblage that was restricted to coastal and continental shelf waters mainly off Washington and Oregon; a slope/transitional assemblage that occurred largely along the shelf edge and slope; a Columbia River plume assemblage; and an oceanic assemblage that prevailed in deep water beyond the shelf edge.” These spawning areas include shallow subtidal eelgrass and algae (for Pacific herring *Clupea harengus pallasii*); rocky reefs (e.g., many *Sebastes* rockfish); deep water (e.g., Dover sole *Microstomus pacificus*); and freshwater rivers and estuaries (e.g., Salmonids).

Marine fish species that are abundant and commercially important in the Northern Study Area include Pacific hake, sablefish, Dover sole, sardines, and salmonids. These species also represent the major life histories of species in the Northern Study Area.

Pacific hake, also known as Pacific whiting, are abundant in the Northern Study Area and the target of industrial scale commercial fisheries. In general, Pacific hake spawn in winter offshore of the shelf break in more than 1,000 m of water from Cape Mendocino to Baja Mexico and migrate to summer feeding grounds off the coasts of California, Oregon, Washington, British Columbia, and southeast Alaska (Bailey et al. 1982; Saunders 1997). The location of the northern spawning front is correlated with sea surface temperatures, indicating that in warm years, spawning may occur at higher latitudes (Bailey et al. 1982). Saunders (1997) notes that the species’ spawning range seems to be shifting northward. Iwamoto et al. (2004) also recognized hake spawning populations in Port Susan Bay, Puget Sound, and the south central Strait of Georgia, British Columbia, Canada.

Sablefish (*Anoplopoma fimbria*) range from the Aleutian chain to Baja California, and are an important component of commercial fisheries in the Northern Study Area. Sablefish spawn throughout their range on the continental shelf and slope in water deeper than 200 m (Moser et al. 1994). Moser et al. (1994) note a decrease in abundance of sablefish larvae in plankton tows from north to south, with mean abundance decreasing by one-half from Washington to northern Oregon and again from northern Oregon to southern Oregon, then by about 80 percent from southern Oregon to northern and central California and by almost 100 percent at Southern California. Larval abundance peaks in February off central California and in March off Northern California and southern Oregon, and peaks sharply in April off northern Oregon and Washington (Moser et al. 1994).

Dover sole (*Microstomus pacificus*) spawn on or near the bottom on the Outer Continental Shelf and upper slope from the Bering Sea to southern Baja, California. They are batch spawners, with epipelagic eggs found in the upper 160 feet of the water column. Spawning season is from November to April off Oregon and California (USDOD, NMFS 2009a).

Spawning strategies for resident pelagic species may be timed around oceanographic processes, such as upwelling, and focused on areas that support primary productivity (such as coastal upwelling zones, seamounts, banks, and plumes). For example, Lynn (2003) found a strong correlation between spatial patterns of sardine (*Sardinops* spp.) eggs and zooplankton biomass

off central and Southern California. The inshore distribution of spawning was limited by low temperatures of freshly upwelled waters. An abrupt offshore decrease in zooplankton density was coincident with the offshore boundary of eggs (Lynn 2003). This suggests that sardines have evolved a strategy for spawning ground selection and timing that promotes favorable food supply conditions for larval development (Lynn 2003). Parameters such as sea surface temperature and zooplankton biomass can be used to delineate the boundaries of crucial sardine spawning habitat (Lynn 2003).

Freshwater rivers and estuaries provide spawning habitat for salmonid species, American shad, white sturgeon, and other commercially and recreationally targeted species. The Columbia, Klamath, San Joaquin, and Sacramento Rivers are the major spawning rivers for salmonids in the Northern Study Area, but many smaller rivers and streams are used as well. Estuaries such as Willapa Bay, Grays Harbor, the lower Columbia River estuary, Tillamook Bay, Humboldt Bay, and San Francisco Bay provide sheltered habitats for juveniles of many species, including salmonids, English sole, and sturgeon.

7.2 LIFE HISTORIES

Life history traits are the characteristics of fish species that reflect evolutionary and adaptive responses to the surrounding environment. These traits are what enable the organism to exist in its associated habitat. Life history characteristics include growth, mortality, recruitment, reproduction, life stages, feeding, movement, and behavioral responses. Growth and mortality in fish species are generally correlated. Fish with low natural adult mortality rates grow slowly, mature late, and have low annual reproductive output; whereas species with high natural adult mortality rates tend to be fast growers, mature quickly, and have high annual reproductive output (Cross and Allan 1993).

Fish in the Northern Study Area display a wide variety of life history strategies. Some, like the Dover sole, spend most of their lives in marine waters off the coast and in deeper offshore waters. Many salmonids spawn in freshwater estuaries and rivers but spend their adult lives in marine waters. Many sturgeon (Acipenseridae) spawn in freshwater, rarely enter the marine environment, and forage as adults in estuaries and rivers. Still other species, like the English sole (*Parophrys vetulus*), may utilize either shallow coastal areas or coastal estuaries for part of the juvenile stages as rearing grounds before entering their fully marine phase.

Migration, usually between breeding grounds and feeding grounds, is an important element in many fish species' life histories. Anadromous species, such as salmon, spawn in freshwater and spend their adult lives in the marine environment. Catadromous species spawn in saltwater and migrate into freshwater when they reach maturity. The Pacific hake is unorthodox among groundfish species in that it is highly migratory, swimming long distances to southern breeding grounds in the winter and dispersing northward to feed in the summer months (McCain et al. 2005). Other marine species, like arrowtooth flounder (*Atheresthes stomias*), migrate from shallow-water feeding grounds in the summer to deepwater breeding grounds on the shelf slope in the winter (McCain et al. 2005). Highly migratory pelagic species, like tuna, sharks, billfish, and rays move throughout the Pacific Ocean. Still other species, such as many species and

populations of rockfish, have high site fidelity and may spend much of their lives in the same location.

Reproductive strategies also vary greatly among fish in the Northern Study Area. Most groundfish species are oviparous with external fertilization, which means eggs are laid and fertilized, and they develop, and hatch, outside of the female. Some species, such as the Dover sole and arrowtooth flounder, are batch spawners, spawning multiple times with fertilized eggs released into the plankton. Other species, like lingcod (*Ophiodon elongates*) and cabezon (*Scorpaenichtys marmoratus*), lay egg masses on rocky reefs, which are fertilized and guarded by the male. All rockfish species, with the exception of the *Sebatolobus* spp., are viviparous (McCain et al. 2005), meaning the embryo is fertilized and develops inside the body of the mother. Many species of sharks, including the leopard shark (*Triakis semifasciata*), soupfin shark (*Galeorhinus zyopterus*), and spiny dogfish (*Squalus acanthias*), are also viviparous, giving birth to fully formed young. Rays, skates, and chimaera are all oviparous; eggs are fertilized internally and laid on the bottom, covered with a thick leathery shell. When eggs hatch, juveniles are fully developed with an attached yolk sac that is slowly absorbed (McCain et al. 2005). Many pelagic species are broadcast spawners, releasing eggs and sperm in surface waters. Bentley et al. (1996) found an association between the geographic distribution of Pacific sardine egg concentrations and the 14°C isotherm derived from the 1-to-10-m depth zone off the coast of Oregon.

Recruitment refers to the addition of new members to a population through reproduction and immigration. Larvae and juvenile demersal fish species may spend time in the plankton before recruiting to the benthos later in life. Rockfish larvae utilize this strategy (McCain et al. 2005). Other species, like lingcod and cabezon, recruit directly to habitat utilized by adults of the same species, gradually moving to deeper water as they mature (McCain et al. 2005). Conditions affecting recruitment in the Northern Study Area include availability of food and habitat, predation, competition, events like ENSO and PDO, and ocean circulation (McClatchie et al. 2008).

Factors that determine diet include body shape, feeding behavior, and capture and feeding mechanism. Capture and feeding mechanisms may be described as biting, suction and ram feeding, suspension feeding, and pharyngeal jaw crushing (Horn and Ferry-Graham 2006). Trophic categories include herbivores, detritivores, carnivores, and omnivores. The carnivorous group can be divided into zooplankton feeders, benthic invertebrate feeders, and piscivores (fish-eaters). In the Northern Study Area, zooplankton feeders include anchovies (*Anchoa* spp.) and sardines (*Sardinops* spp). Examples of benthic invertebrate feeders include several groundfish and flatfish species such as sole (*Solea* spp.). Piscivorous fish in the Northern Study Area include Pacific hake, jack mackerel (*Trachurus symmetricus*), chub mackerel (*Scomber japonicus*), spiny dogfish, and adult salmonids (Emmet et al. 2006).

7.3 COMMERCIAL AND RECREATIONAL FISHING

There are many fish species caught in the Northern Study Area, both recreationally and commercially. Landings for specific species or groups can be found in the landing reports published each year by NMFS and each of the three states, Washington, Oregon, and California.

Commercial and recreational species are usually divided into groups based on their location in the environment. In general, there are two types of pelagic species: resident and migratory (see [Table 7.1](#)). Resident pelagics, such as sardines, anchovies, and mackerel, can have very high landing weights due to their large numbers. Sometimes salmonids (see [Section 7.4](#) for most species) are placed in this group, although the fishery often takes place in rivers and estuaries during their migrations. Migratory pelagic fish tend to be higher order predators, like tuna and sharks, individuals of which can be much larger than the residents. The other group of fish is loosely called groundfish due to their association with the sea floor. There are more than 80 species of groundfish listed by NMFS, including rockfish, flatfish, round fish, elasmobranchs, and some smaller taxa (see [Table 7.2](#)).

According to NMFS landing data (USDOC, NMFS 2009b), Pacific hake was the largest groundfish fishery in Washington and Oregon in 2007 (the most recent year for which data are available). In 2007, 91.2 million pounds of Pacific hake were landed in Washington waters (statewide), worth \$7.1 million. The Oregon catch was slightly less at 81.4 million pounds, worth \$6.5 million. In California, the hake catch was a fraction of that in Oregon and Washington at 5.8 million pounds, while Dover sole was the top groundfish species with 6.1 million pounds landed; nearly all of both species were caught in waters north of Monterey Bay (California Fish and Game 2009). By value, Pacific halibut (*Hippoglossus stenolepis*) is the most valuable groundfish species in Washington (WDFW 2009), with 2.3 million pounds landed, worth \$8.8 million. Pacific halibut landings in Oregon totaled 0.243 million pounds, worth \$0.8 million, while California halibut (*Paralichthys californicus*) landings in California totaled 0.39 million pounds, worth \$1.8 million (USDOC, NMFS 2009b). Sablefish is the top groundfish species by value in Oregon and California, with 5.3 million pounds landed, worth \$9.5 million, in Oregon, and 3.2 million pounds landed, worth \$4.9 million, in California (of which nearly 2 million pounds were from Monterey Bay and north) (USDOC, NMFS 2009b, California Fish and Game 2009). Sablefish landings in Washington totaled 3 million pounds, worth \$6.6 million (USDOC, NMFS 2009b). Many types of gear are used to target groundfish, with trawl gear responsible for most of the fish landed in the Northern Study Area. Troll, longline, hook and line, pots, and gillnets are also used (PFMC 2009a).

The Pacific sardine, mackerel species, and tuna species dominate pelagic fisheries in Washington, Oregon, and California (while salmonids can be considered a pelagic species, they are managed separately and described below). In Washington, albacore tuna (*Thunnus alalunga*) was the largest pelagic fishery by weight and value, with 13.1 million pounds landed for a value of \$10.4 million in 2007, while the Pacific sardine fishery landed 10.2 million pounds, worth \$480 thousand (USDOC, NMFS 2009b). Oregon's albacore tuna fishery is comparable to Washington's, landing 10.4 million pounds, worth \$9.4 million, while its Pacific sardine fishery is much larger, landing more than 90 million pounds in 2007, worth \$4.5 million (USDOC, NMFS 2009b). In 2007, the Pacific sardine fishery was California's largest by weight at 178.5 million pounds, worth \$8.2 million (USDOC, NMFS 2009b). Of this, approximately 80 million pounds were caught in the waters around Monterey Bay and north (California Fish and Game 2009). Albacore tuna landings were much lower in California than in Oregon and Washington, at 1.8 million pounds (1.2 million pounds from Monterey Bay and north). Mackerel species are

an important component of California's pelagic fishery, with Pacific mackerel (*Scomber japonicus*) landings of 11.1 million pounds, worth \$788 thousand in 2007 (though most of this is caught south of the Northern Study Area) (California Fish and Game 2009). Pelagic species in the Northern Study Area are landed with a variety of gear, including purse seine nets, drum seines, lampara nets, and dip nets. Pelagic species are also taken as incidental catch (bycatch) with midwater trawls, pelagic trawls, gillnets, trammel nets, troll, pots, hook-and-line, and jigs (PFMC 2009b).

The Pacific Fishery Management Council manages Chinook (*Oncorhynchus tshawytscha*) and coho salmon (*Oncorhynchus kisutch*). Salmon are anadromous, meaning they hatch in freshwater rivers and streams, migrate to the open ocean to feed and grow for several years, and return to their natal waters to spawn, where they die. Commercial, sport, and tribal fishers target salmon in both the ocean and the rivers. In general, salmon fisheries in the Northern Study Area have been in a state of decline over the last several decades, with habitat loss, hydroelectric dams, freshwater diversion, interactions with hatchery fish, and harvest all contributing to declining runs (USDOC, NMFS 2009b). Ocean conditions also strongly influence salmon stocks, with the PDO and ENSO ([described in section 7.1](#)) cyclical drivers of production and salmon growth in the open ocean. In 2007 and 2008, the commercial and recreational salmon fishery was closed off the coast of California and southern Oregon due to the failure of the Sacramento River Fall Chinook run (State of California 2009). The ocean salmon fishery remained open in northern Oregon and Washington.

NMFS landing data over the past 25 years (USDOC, NMFS Fisheries 2009b) show a sharp drop in salmon landings in Washington, Oregon, and California in the late 1980s, followed by several strong years in the mid 2000s. In 2007, 3 million pounds of Chinook salmon, worth \$6.9 million, and 2.5 million pounds of coho, worth \$3.8 million, were landed in Washington waters. Oregon fishers landed 1 million pounds of Chinook, worth \$4.1 million, and 321,000 pounds of coho, worth \$500 thousand. For comparison, in 1987, Oregon fishers landed 11.5 million pounds of Chinook and 3 million pounds of coho. Similarly in Washington that same year, fishers caught 8.4 million pounds of Chinook and 12.7 million pounds of coho. And in California that year, fishers caught 10.4 million pounds of Chinook salmon; the next year, in 1988, the California Chinook fishery landed 16.6 million pounds before crashing to 6.4 million pounds in 1989 and declining steadily since then.

Recreational and subsistence fisheries are also important in the Northern Study Area. Halibut is a high-demand species for both sport and tribal fishermen in Washington, Oregon, and California. Closed seasons, bag limits, and possession limits are all used to control the recreational fishery and extend the season as long as possible (PFMC 2009c). In 1995, the United States prohibited directed nontreaty commercial fishing north of Pt. Chehalis, Washington, in order to allow the tribes to harvest their allocation of halibut (PFMC 2009c). Chinook and coho salmon are both prized by recreational and tribal fishermen. In 2008 and 2009, most recreational salmon fishing was closed off the coast of California due to the collapse of the Sacramento River fall Chinook run. Chinook and coho salmon remain an important part of the culture and diet of many tribes in the Northern Study Area. In Washington State, treaty tribes comanage fisheries along with the State and Federal governments.

Table 7.1.

Common and Scientific Names of Pelagic Species Generally Caught in the Northern Study Area

Common Name	Scientific Name
RESIDENT PELAGICS	
Pacific sardine	<i>Sardinops sagax</i>
Pacific mackerel (chub)	<i>Scomber japonicus</i>
Jack mackerel	<i>Trachurus symmetricus</i>
Northern anchovy	<i>Engraulis mordax</i>
MIGRATORY SPECIES	
Albacore tuna	<i>Thunnus alalunga</i>
Yellowfin tuna	<i>T. albacares</i>
Skipjack tuna	<i>Katsuwonus pelamis</i>
Bluefin tuna	<i>Thunnus thynnus</i>
Bigeye tuna	<i>Thunnus obesus</i>
Swordfish	<i>Xiphias gladius</i>
Common thresher shark	<i>Alopias vulpinus</i>
Shortfin mako	<i>Isurus oxyrinchus</i>
Blue shark	<i>Prionace glauca</i>

Source: adapted from Sweetman (2005)

Table 7.2.

Common and Scientific Names of Species Included in the Pacific Groundfish FMP

Common Name	Scientific Name
SHARKS	
Big skate	<i>Raja binoculata</i>
California skate	<i>R. inornata</i>
Leopard shark	<i>Triakis semifasciata</i>
Longnose skate	<i>R. rhina</i>
Soupin shark	<i>Galeorhinus zyopterus</i>
Spiny dogfish	<i>Squalus acanthias</i>
RATFISH	
Ratfish	<i>Hydrolagus colliei</i>
MORIDS	
Finescale codling	<i>Antimora microlepis</i>
GRENADIERS	
Pacific rattail	<i>Coryphaenoides acrolepis</i>
ROUNDFISH	
Cabazon	<i>Scorpaenichthys marmoratus</i>
Kelp greenling	<i>Hexagrammos decagrammus</i>
Lingcod	<i>Ophiodon elongatus</i>
Pacific cod	<i>Gadus macrocephalus</i>
Pacific whiting (hake)	<i>Merluccius productus</i>
Sablefish	<i>Anoplopoma fimbria</i>
ROCKFISH^a	
Aurora rockfish	<i>Sebastes aurora</i>
Bank rockfish	<i>S. rufus</i>
Black rockfish	<i>S. melanops</i>
Black and yellow rockfish	<i>S. chrysomelas</i>
Blackgill rockfish	<i>S. melanostomus</i>
Blue rockfish	<i>S. mystinus</i>
Bocaccio	<i>S. paucispinis</i>
Bronzespotted rockfish	<i>S. gilli</i>
Brown rockfish	<i>S. auriculatus</i>
Calico rockfish	<i>S. dallii</i>
California scorpionfish	<i>Scorpaena gutatta</i>
Canary rockfish	<i>Sebastes pinniger</i>
Chameleon rockfish	<i>S. phillipsi</i>
Chilipepper	<i>S. goodei</i>
China rockfish	<i>S. nebulosus</i>
Copper rockfish	<i>S. caurinus</i>
Cowcod	<i>S. levis</i>
Darkblotched rockfish	<i>S. crameri</i>
Dusky rockfish	<i>S. ciliatus</i>
Dwarf-red rockfish	<i>S. rufinanus</i>
Flag rockfish	<i>S. rubrivinctus</i>
Freckled rockfish	<i>S. lentiginosus</i>
Gopher rockfish	<i>S. carnatus</i>
Grass rockfish	<i>S. rastrelliger</i>
Greenblotched rockfish	<i>S. rosenblatti</i>
Greenspotted rockfish	<i>S. chlorostictus</i>
Greenstriped rockfish	<i>S. elongatus</i>
Halfbanded rockfish	<i>S. semicinctus</i>
Harlequin rockfish	<i>S. variegatus</i>
Honeycomb rockfish	<i>S. umbrosus</i>
Kelp rockfish	<i>S. atrovirens</i>
Longspine thornyhead	<i>Sebastolobus altivelis</i>
Mexican rockfish	<i>Sebastes macdonaldi</i>

Source: McCain et al. (2005)

Table 7.2 Common and Scientific Names of Species Included in the Pacific Groundfish FMP (Contd.)

Common Name	Scientific Name
ROCKFISH (contd.)	
Olive rockfish	<i>Sebastes serranoides</i>
Pink rockfish	<i>S. eos</i>
Pinkrose rockfish	<i>S. simulator</i>
Pygmy rockfish	<i>S. wilsoni</i>
Pacific ocean perch	<i>S. alutus</i>
Quillback rockfish	<i>S. maliger</i>
Redbanded rockfish	<i>S. babcocki</i>
Redstripe rockfish	<i>S. proriger</i>
Rosethorn rockfish	<i>S. helvomaculatus</i>
Rosy rockfish	<i>S. rosaceus</i>
Rougheye rockfish	<i>S. aleutianus</i>
Sharpchin rockfish	<i>S. zacentrus</i>
Shortbelly rockfish	<i>S. jordani</i>
Shortraker rockfish	<i>S. borealis</i>
Shortspine thornyhead	<i>Sebastolobus alascanus</i>
Silvergray rockfish	<i>Sebastes brevispinis</i>
Speckled rockfish	<i>S. ovalis</i>
Splitnose rockfish	<i>S. diploproa</i>
Squarespot rockfish	<i>S. hopkinsi</i>
Starry rockfish	<i>S. constellatus</i>
Stripetail rockfish	<i>S. saxicola</i>
Swordspine rockfish	<i>S. ensifer</i>
Tiger rockfish	<i>S. nigrocinctus</i>
Treefish	<i>S. serriceps</i>
Vermilion rockfish	<i>S. miniatus</i>
Widow rockfish	<i>S. entomelas</i>
Yelloweye rockfish	<i>S. ruberimus</i>
Yellowmouth rockfish	<i>S. reedi</i>
Yellowtail rockfish	<i>S. flavidus</i>
FLATFISH	
Arrowtooth flounder (turbot)	<i>Atheresthes stomias</i>
Butter sole	<i>Isopsetta isolepis</i>
Curlfin sole	<i>Pleuronichthys decurrens</i>
Dover sole	<i>Microstomus pacificus</i>
English sole	<i>Parophrys vetulus</i>
Flathead sole	<i>Hippoglossoides elassodon</i>
Pacific sanddab	<i>Citharichthys sordidus</i>
Petrale sole	<i>Eopsetta jordani</i>
Rex sole	<i>Glyptocephalus zachirus</i>
Rock sole	<i>Lepidopsetta bilineata</i>
Sand sole	<i>Psettichthys melanostictus</i>
Starry flounder	<i>Platichthys stellatus</i>

a The category “rockfish” includes all genera and species of the family Scopaenidae, even if not listed, that occur in the Washington, Oregon, and California area. The Scopaenidae genera are *Sebastes*, *Scorpaena*, *Sebastolobus*, and *Scorpaenodes*.

7.4 THREATENED AND ENDANGERED SPECIES

Species that are listed as “threatened” or “endangered” under the Endangered Species Act (ESA) that occur in the Northern Study Area include populations of Chinook salmon (*Oncorhynchus tshawytscha*), some stocks of chum salmon (*O. keta*), coho salmon (*O. kisutch*), steelhead (*Oncorhynchus mykiss*) as well as the North American green sturgeon (*Acipenser medirostris*), and delta smelt (*Hypomesus transpacificus*) ([Table 7.3](#)).

ESA-listed salmonids that utilize the Northern Study Area are [listed in Table 7.3](#). A number of factors have contributed to the decline in populations of West Coast salmon species over recent decades, including natural conditions (e.g., drought conditions or cyclical ocean conditions); water management activities (e.g., construction of dams and depletion of water supplies); overharvesting (both recreational and commercial); predation and competition from introduced nonnative species and hatchery-raised salmonids; and changes in water quality (USDOI MMS 2007).

The green sturgeon is broadly distributed along the West Coast from Mexico to the Bering Sea. Adams et al. (2002) determined that the green sturgeon comprises two distinct population segments (DPS) that qualify as species under the ESA. Following an updated status review in 2005, NMFS concluded that the northern green sturgeon DPS warranted listing only on the Species of Concern List and proposed that the southern DPS be listed as threatened under the ESA. NMFS published a final rule listing the southern DPS of the green sturgeon as threatened in 2006. Adult individuals spend most of their lives in nearshore oceanic waters, bays, and estuaries. Spawning occurs in deep freshwater rivers. Adults migrate into freshwater areas for spawning in late winter. Juveniles stay in freshwater and estuarine areas for one to four years. Green sturgeon forage in estuaries and bays ranging from San Francisco Bay to British Columbia. Principal food items include benthic invertebrates such as shrimp, mollusks, and amphipods; they will also consume small fish (Adams et al. 2002). The decline of the southern DPS of the green sturgeon is primarily related to the reduction of the available spawning area to a limited section of the Sacramento River. See USDOI MMS (2007) for a full description of North American green sturgeon and its status.

Delta smelt, listed as threatened, are found in Suisun Bay, a shallow tidal estuary located off San Francisco Bay in central California, and in upstream locations in Contra Costa, Sacramento, San Joaquin, Solano, and Yolo counties (USDOI MMS 2007). The combination of factors behind the decline of delta smelt includes low or excessively high outflows from the Sacramento and San Joaquin rivers, entrainment into water diversions, changes in food availability, and introduction of toxic substances. See USDOI MMS (2007) for a full description of the Delta Smelt and its status.

Table 7.3.

Endangered Species Act Threatened and Endangered Fish Species in the Northern Study Area

Species	Population	ESA Status
North American Green Sturgeon (<i>Acipenser medirostris</i>)	Northern	Species of Concern
	Southern	Threatened
Delta Smelt (<i>Hypomesus transpacificus</i>)		Threatened
Sockeye (<i>Oncorhynchus nerka</i>)	Snake River	Endangered
	Ozette Lake	Threatened
Chinook (<i>Oncorhynchus tshawytscha</i>)	Sacramento River Winter-run	Endangered
	Upper Columbia River Spring-run Chinook	Endangered
	Snake River Winter-run	Threatened
	Snake River Fall-run	Threatened
	Puget Sound	Threatened
	Lower Columbia River	Threatened
	Upper Willamette River	Threatened
	Central Valley fall and Late Fall-run	Species of Concern
Coho (<i>Oncorhynchus kisutch</i>)	Central California Coast	Endangered
	Southern Oregon/Northern California	Threatened
	Lower Columbia River	Threatened
	Oregon Coast	Threatened
	Puget Sound/Strait of Georgia	Species of Concern
Chum (<i>Oncorhynchus keta</i>)	Hood Canal Summer-run	Threatened
	Columbia River	Threatened
Steelhead (<i>Oncorhynchus mykiss</i>)	Southern California	Endangered
	Upper Columbia River	Endangered
	Central California Coast	Threatened
	South Central California Coast	Threatened
	Snake River Basin	Threatened
	Lower Columbia River	Threatened
	California Central Valley	Threatened
	Upper Willamette River	Threatened
	Middle Columbia River	Threatened
	Northern California	Threatened
	Oregon Coast	Species of Concern
	Puget Sound	Threatened

Source: NOAA Northwest Regional Office, updated September 2008

7.5 FISHES OF THE PELAGIC ZONE

7.5.1 Epipelagic

The epipelagic zone includes the water column covering the shelf and the upper 200 m of water overlying the slope and deep basin. The “coastal” or “neritic” epipelagic zone refers to the area from the surf zone to the continental shelf break. The oceanic epipelagic zones are areas over the slope and deep basins.

Epipelagic fish are adapted to a habitat void of physical structure or visual reference points. The assemblage is composed of small suspension feeders (e.g., anchovies and sardines) as well as larger predators such as tunas. Many of these species are commercially harvested. Species that exist in this habitat are countershaded, have round body shapes, and have forked or lunate caudal fins. Epipelagic fish typically exhibit schooling behavior and undertake long migrations to foraging areas (typically areas of upwelling) and spawning habitats. Fish from this zone represent a mix of permanent residents and periodic visitors. With the exception of several subtropical species, epipelagic fishes have extensive ranges that cover most of the Pacific region. Species considered highly migratory in the Pacific Ocean include tunas, swordfish, marlins, sailfish, oceanic sharks, and others (PFMC 2009b).

According to surveys in the Northern Study Area (Emmett and Brodeur 2000; Brodeur et al. 2005; Emmett et al. 2005; Krutzikowsky and Emmett 2005), the most common epipelagic fish include Pacific herring, Pacific sardines, northern anchovy, mackerel, hake, juvenile salmonids, American shad, surf smelt (*Hypomesus pretiosus*), and whitebait smelt (*Allosmerus elongates*). The relative dominance of any one species shifts over time because of a number of factors including population dynamics, time of day, and sea surface temperature.

7.5.2 Ichthyoplankton

Ichthyoplankton consists of the eggs and larvae of fish species found among other planktonic organisms that are unable to counter the movements of their environment. Most fish species are broadcast spawners and thus release eggs and sperm into the water column. Additionally, demersal spawners that attach eggs to the substrate tend to have pelagic larvae. Once fertilized, the eggs and hatched larvae are moved around by diffusion and advection of oceanic currents. Fertilized eggs are immotile, whereas newly hatched larvae are capable of feeble movement and become more motile with development.

Larval mortality and recruitment success depend on factors such as yolk-sac quality, transport, turbulence, predation, and starvation (Cross and Allen 1993). Because of the susceptibility of young to ocean currents, the release location of eggs is an important mechanism in controlling the fate of resulting larvae. Therefore, fish species have developed either to take advantage of the dispersal properties of oceanic currents or try to avoid their influence. One important component to larval dispersal is encountering areas of high productivity where larval fish can feed on phytoplankton and zooplankton blooms. The timing of spawning events is often associated with seasonal blooms of productivity. Larval fish, therefore, often inhabit the same parts of the water column as do other members of the water column community. This includes time spent at the surface, where phytoplankton production is high (Auth 2008).

Ichthyoplankton is diverse in the Northern Study Area as many of the species spend part of their life cycle as planktonic larvae. In one survey of ichthyoplankton in the area, Doyle (1992) found 25 species of fish eggs from 17 families in plankton tows, with additional specimens identifiable only to higher taxa. The same study found even higher diversity in larval fish, with 46 species representing 24 families. Auth (2008) found similarly high diversity with 56 taxa over 23 families. Dominant representatives in this latter study included *Citharichthys* spp. flatfish, *Sebastes* spp. rockfish, anchovetta (*Engraulis mordax*), lanternfish (*Stenobrachius leucopsarus*), Pacific sardine, and hake.

7.5.3 Mesopelagic and Bathypelagic

The mesopelagic or midwater zone is from 200 to 1,000 m in depth located over the shelf slope and deep basins. The bathypelagic zone includes areas more than 1,000 m deep. Midwater trawling, oblique tows, and data from submersible expeditions are the main methods of fish collection from these areas. Due to the complexity of data collection, less is known about the fish in the mesopelagic and bathypelagic zones. Fish species in these zones have large eyes, jaws and teeth, and feed on deepwater invertebrates. Meso- and bathypelagic species spawn at depth, and their eggs and larvae rise toward the surface. Larvae of deepwater species utilize the zooplankton resources of the euphotic zone. Juvenile and young fish then migrate back down to deeper waters (Brodeur et al. 2003).

Little data exist for deeper pelagic fish populations in the Northern Study Area. One study suggests that while species like juvenile rockfish may persist at depth, the more dominant species are likely to be commercially unimportant species like myctophid lanternfish (Brodeur et al. 2003). In general, however, pelagic fish diversity decreases with depth (Smith and Brown 2002).

7.6 FISHES OF SOFT SUBSTRATES

Soft substrate is the most abundant benthic habitat found in the Northern Study Area. Areas consisting of soft substrate include bays and estuaries, surf zones, and the continental shelf and slope. “Soft substrate,” or “soft sediment,” refers to unconsolidated sediments ranging from fine silts and clays to coarse well-sorted sands. Each of these soft sediment habitats supports a unique assemblage of pelagic, demersal, and benthic fish species.

Numerous fish are known to associate with soft substrate in the Northern Study Area during part or all of their life cycle ([see Figure 7.2](#)) (McCain et al. 2005). These fish are largely members of the flatfish and cartilaginous fish families, although members of the rockfish and roundfish families are represented in the group. Many of the rockfish still prefer some amount of hard substrate mixed with the soft substrate, including attractors like small boulders in sand flats. Many studies have analyzed the data available on the species found in these habitats and have attempted to identify assemblages of fish species that are often found together (Jay 1996; Tolimieri and Levin 2006) and are generally managed as a group.

Depth and latitude are factors that influence distribution of groundfish assemblages in the Northern Study Area, with abrupt changes in assemblage structure at the 500-to-600-m depth range and the latitudinal vicinity of Cape Blanco, Oregon, and Cape Mendocino and Point

Conception, California (Tolimieri and Levin 2006). Using depth and latitude, Tolimieri and Levin (2006) identified five broad assemblages: (1) a deepwater assemblage with a broad latitudinal range (Grenadiers, soles, skates); (2) a Southern shallow-water assemblage (ratfish, English soles); (3) a shallow-water midlatitude assemblage (spiny dogfish, longnose skate, Pacific hakes); (4) a shallow northerly assemblage (arrowtooth flounder, rockfish); and (5) a shallow-middepth and midlatitude southern grouping (sablefish, dover sole, shortspine thorny heads).

Table 3. Species and life stages associated with soft and mixed hard/soft bottoms on the continental shelf.

Species	Adults	Juveniles	Larvae	Eggs	Species	Adults	Juveniles	Larvae	Eggs
Leopard Shark	X*†				Kelp Rockfish				
Soupin Shark	X	X			Longspine Thornyhead				
Spiny Dogfish	X	X			Mexican Rockfish				
Big Skate	X	X		X	Olive Rockfish				
California Skate	X	X		X	Pacific Ocean Perch	X			
Longnose Skate	X**	X**			Pink Rockfish	X*	X		
Spotted ratfish	X	X		X	Quillback Rockfish	X*	X**		
Pacific Flatnose					Redbanded Rockfish	X**	X		
Pacific Grenadier					Redstripe Rockfish	X*	X*		
Lingcod		X			Rosethorn Rockfish	X*	X		
Cabezon					Rosy Rockfish	X*	X*		
Kelp Greenling					Rougheye Rockfish	X**	X		
Pacific Cod	X	X		X	Sharpchin Rockfish	X*	X**		
Pacific Hake					Shortbelly Rockfish	X	X*		
Sablefish		X			Shortraker Rockfish	X**			
Aurora Rockfish	X	X			Shortspine Thornyhead	X**	X**		
Bank Rockfish	X*	X			Silverygray Rockfish				
Black Rockfish		X*			Speckled Rockfish				
Black-and-Yellow Rockfish		X*			Splitnose Rockfish	X**	X**		
Blackgill Rockfish		X			Squarespot Rockfish				
Blue Rockfish					Starry Rockfish				
Bocaccio	X**	X**			Stripetail Rockfish	X**	X		
Bronzespotted Rockfish					Tiger Rockfish				
Brown Rockfish					Treefish				
Calico Rockfish	X*	X**			Vermilion Rockfish		X**		
California Scorpionfish	X				Widow Rockfish	X*	X**		
Canary Rockfish	X*	X*			Yelloweye Rockfish	X*			
Chilipepper	X	X			Yellowmouth Rockfish				
China Rockfish					Yellowtail Rockfish	X**			
Copper Rockfish	X*	X*			Arrowtooth Flounder	X**	X**		
Cowcod		X**			Butter Sole	X	X		
Darkblotched Rockfish	X**	X**			Curlfin Sole	X	X		
Dusky Rockfish					Dover Sole	X†	X	X	
Flag Rockfish					English Sole	X	X		
Gopher Rockfish		X*			Flathead Sole	X	X		
Grass Rockfish		X*			Pacific Sanddab	X**	X**		
Greenblotched Rockfish	X*	X*			Petrale Sole	X	X		
Greenspotted Rockfish	X**	X			Rex Sole	X	X		
Greenstriped Rockfish	X**	X**			Rock Sole	X**	X**		X
Harlequin Rockfish					Sand Sole	X	X		
Honeycomb Rockfish		X			Starry Flounder	X			

* Indicates association with mixed hard and soft habitat.
 ** Indicates association with both soft and mixed hard and soft habitat.
 † Indicates a weak association with soft-bottom habitats.

Figure 7.2. Species and life stages associated with soft and mixed hard/soft bottoms on the continental shelf.

Source: Table scanned from McCain et al. 2005.

7.7 FISHES OF HARD SUBSTRATES AND KELP BEDS

Hard substrate, though it accounts for just a small fraction of total habitat in the Northern Study Area, provides important refugia and complex habitat for rich assemblages of species. In the nearshore, kelp and rocky reef habitat is extremely productive. While offshore, fish aggregate at seamounts, banks, and other benthic features where hard substrate and upwelling create conditions in which both invertebrate and fish species thrive (Koslow et al. 2000). Banks and seamounts are often targeted by commercial fisheries, and are also often the focus of conservation efforts. Heceta Bank, located around 15 to 30 miles off the Oregon Coast between Newport and Eugene at a depth of 180 to 400 feet, is a major commercial fishing area. Cordell Bank is a 4.5-to-9.5-mile-long granitic bank located 18 miles west of the Point Reyes Lighthouse. Cordell Bank supports more than 246 species of fish, including 44 species of rockfish, and is protected by a National Marine Sanctuary (Cordell Bank National Marine Sanctuary 2009).

7.7.1 Rocky Intertidal

The rocky intertidal areas of the Northern Study Area are highly productive and rich in macrophytes and invertebrates. Fish species living in these habitats, especially tide pools, must be capable of enduring extreme physical and chemical conditions. Intertidal fish protect themselves from surge and wave action by inhabiting holes, rock crevices, or algae (Cross and Allen 1993). These areas are subjected to daily fluctuations of water level, temperature, and salinity.

In general, the rocky intertidal is not ideal habitat for many fish in the Northern Study Area. While there may be some smaller fish, such as gobies (Gobiidea), pricklebacks (Stichaeidae), gunnels (Pholididae), and sculpins (Cottidae), that may take full advantage of the location (e.g., Yoshiyama and Cech 1994), most commercially important species in the area are likely to be hard-substrate species opportunistically using the substrate as the tide floods, rather than residents of the habitat (McCain et al. 2005). Many of these harvested species are juveniles or are associated with algae growing on the hard substrate (e.g., [Figure 7.3](#)) (McCain et al. 2005).

7.7.2 Rocky Reefs and Kelp Beds

Rocky reefs are productive areas for fish biomass in the Northern Study Area, a fact that is reflected in their often being designated as HAPC throughout the region. Most of the commercially important species are associated with these structures during multiple life stages (e.g., [Figure 7.4](#); McCain et al. 2005). Rockfish in particular are known for their association with hard substrate, and the lack of hard substrate can be a demographic bottleneck for many populations. Rocky reefs and kelp beds provide physical structure for refuge or cover for predators and usually offer abundant food resources (invertebrates as well as harvested and unharvested fish). It is also common for a small amount of hard substrate to change the community present in otherwise soft-bottomed habitats (Levin 1993).

Macroalgal beds provide productive fish habitat in the Northern Study Area. Many fish are known to associate with autotrophic communities (see [Figure 7.5](#) and McCain et al. (2005) for commercial species), including canopy kelp beds like *Nereocystis*, as well as understory

macroalgal communities and seagrass meadows. Like their rocky counterparts, these habitats can provide forage and refugia for many fish species and often concentrate biomass in an area.

Factors that affect fish assemblage include depth, temperature, bottom type, vertical relief, and vegetative cover. Climate change and temperature regime shift, such as ENSO and PDO, affect productivity and thus are critical factors in understanding the population dynamics of kelp forest assemblages (Stephens et al. 2006).

Spawning and larval recruitment in kelp forests are not well understood. Passive drift, active swimming of late stage larvae or early stage juveniles, or larval retention around reef habitat may be species-specific, and all play significant roles in the recruitment process (Stephens et al. 2006).

More than 150 species of fish can be found in and near kelp forests. Taxa contributing the greatest biomass, numerical abundance, or species richness to the rock-reef and kelp-forest community are Acanthopterygians (spiny-finned fish), including Serranidae, Pomacentridae, Labridae, Kyphosidae, Embiotocidae, Scorpaenidae (especially *Sebastes* spp.), Hexagrammidae, Gobiidae, and Cottidae (Hobson 1994). Colder-water species that dominate kelp forests north of Point Conception include rockfishes (*Sebastes* spp.), surfperches (Embiotocidae), greenlings (Hexagrammidae), and sculpins (Cottidae).

Transient pelagic species from Clupeidae, Engraulidae, Scombridae, Carangidae, and Sciaenidae may play a significant role in the energetics of reef and kelp communities.

Table 7. Species and life stages within the intertidal zone.

Species	Adults	Juveniles	Larvae	Eggs	Species	Adults	Juveniles	Larvae
Leopard Shark	X	X			Kelp Rockfish			
Soupin Shark	X	X			Longspine Thornyhead			
Spiny Dogfish	X	X			Mexican Rockfish			
Big Skate	X				Olive Rockfish	X	X	X
California Skate	X			X	Pacific Ocean Perch			
Longnose Skate					Pink Rockfish			
Spotted ratfish					Quillback Rockfish	X	X	
Pacific Flatnose					Redbanded Rockfish			
Pacific Grenadier					Redstripe Rockfish			
Lingcod	X	X	X	X	Rosethorn Rockfish			
Cabezon	X	X	X	X	Rosy Rockfish			
Kelp Greenling	X	X	X		Rougheye Rockfish			
Pacific Cod					Sharpchin Rockfish			
Pacific Hake		X			Shortbelly Rockfish		X	
Sablefish					Shortraker Rockfish			
Aurora Rockfish					Shortspine thornyhead			
Bank Rockfish					Silverygray Rockfish			
Black Rockfish		X			Speckled Rockfish			
Black-and-Yellow Rockfish	X	X			Splitnose Rockfish			
Blackgill Rockfish					Squarespot Rockfish			
Blue Rockfish					Starry Rockfish			
Bocaccio					Stripetail Rockfish			
Bronzespotted Rockfish					Tiger Rockfish			
Brown Rockfish	X				Treefish			
Calico Rockfish		X			Vermilion Rockfish		X	
California Scorpionfish	X	X			Widow Rockfish			
Canary Rockfish		X			Yelloweye Rockfish			
Chilipepper		X			Yellowmouth Rockfish			
China Rockfish					Yellowtail Rockfish			
Copper Rockfish		X			Arrowtooth Flounder			
Cowcod					Butter Sole			
Darkblotched Rockfish					Curlfin Sole			
Dusky Rockfish					Dover Sole			
Flag Rockfish					English Sole	X	X	
Gopher Rockfish	X†	X†			Flathead Sole			
Grass Rockfish	X	X	X		Pacific Sanddab			
Greenblotched Rockfish					Petrale Sole			
Greenspotted Rockfish					Rex Sole			
Greenstriped Rockfish					Rock Sole	X	X	
Harlequin Rockfish					Sand Sole			
Honeycomb Rockfish					Starry Flounder			

† Indicates a weak association with intertidal habitats.

Figure 7.3. Species and life stages within the intertidal zone

Source: Table scanned from McCain et al. (2005).

Table 2. Species and life stages associated with hard and mixed hard/soft bottoms on the continental shelf.

Species	Adults	Juveniles	Larvae	Eggs	Species	Adults	Juveniles	Larvae	Eggs
Leopard Shark	X*				Kelp Rockfish	X	X		
Soupin Shark					Longspine Thornyhead				
Spiny Dogfish					Mexican Rockfish	X			
Big Skate					Olive Rockfish	X	X		
California Skate					Pacific Ocean Perch	X	X		
Longnose Skate					Pink Rockfish	X**			
Spotted ratfish	X	X		X	Quillback Rockfish	X**	X**		
Pacific Flatnose					Redbanded Rockfish	X*			
Pacific Grenadier					Redstripe Rockfish	X**	X**		
Lingcod	X			X	Rosethorn Rockfish	X**	X**		
Cabezon	X	X		X	Rosy Rockfish	X**	X**		
Kelp Greenling	X	X		X	Rougheye Rockfish	X**			
Pacific Cod		X		X	Sharpchin Rockfish	X**	X*		
Pacific Hake					Shortbelly Rockfish	X	X**		
Sablefish					Shortraker Rockfish	X**			
Aurora Rockfish	X				Shortspine Thornyhead	X*	X*		
Bank Rockfish	X**	X			Silverygray Rockfish	X	X		
Black Rockfish	X	X**			Speckled Rockfish	X	X		
Black-and-Yellow Rockfish	X	X**			Splitnose Rockfish	X*	X*		
Blackgill Rockfish	X†				Squarespot Rockfish	X	X		
Blue Rockfish	X	X**			Starry Rockfish	X	X		
Bocaccio	X**	X**			Stripetail Rockfish	X*	X		
Bronzespotted Rockfish	X				Tiger Rockfish	X	X		
Brown Rockfish	X**	X			Treefish	X	X		
Calico Rockfish	X**	X**			Vermilion Rockfish	X	X*		
California Scorpionfish	X	X			Widow Rockfish	X**	X**		
Canary Rockfish	X**	X**			Yelloweye Rockfish	X**	X		
Chilipepper	X	X			Yellowmouth Rockfish	X			
China Rockfish	X	X			Yellowtail Rockfish	X**	X		
Copper Rockfish	X**	X**			Arrowtooth Flounder	X*	X*		
Cowcod	X	X**			Butter Sole				
Darkblotched Rockfish	X*	X*			Curlfin Sole				
Dusky Rockfish	X	X			Dover Sole				
Flag Rockfish	X	X			English Sole				
Gopher Rockfish	X	X**			Flathead Sole				
Grass Rockfish	X	X**			Pacific Sanddab	X*	X*		
Greenblotched Rockfish	X**	X**			Petrale Sole				
Greenspotted Rockfish	X**	X			Rex Sole				
Greenstriped Rockfish	X**	X*			Rock Sole	X*	X*		
Harlequin Rockfish	X				Sand Sole				
Honeycomb Rockfish	X	X			Starry Flounder				

* Indicates association with mixed hard and soft habitat.
 ** Indicates association with both hard and mixed hard and soft habitat.
 † Indicates a weak association with hard-bottom habitats.

Figure 7.4. Species and life stages associated with hard and mixed hard/soft bottoms on the continental shelf.

Source: Table scanned from McCain et al. (2005).

Table 1. Species and life stages associated with rooted macrophytes, algae, or seagrass in estuarine, intertidal, and continental shelf zones

Species	Adults	Juveniles	Larvae	Eggs	Species	Adults	Juveniles	Larvae	Eggs
Leopard Shark	X	X			Kelp Rockfish	X	X	X	
Soupin Shark					Longspine Thornyhead				
Spiny Dogfish					Mexican Rockfish				
Big Skate					Olive Rockfish	X	X		
California Skate					Pacific Ocean Perch				
Longnose Skate					Pink Rockfish				
Spotted ratfish					Quillback Rockfish	X	X		
Pacific Flatnose					Redbanded Rockfish				
Pacific Grenadier					Redstripe Rockfish				
Lingcod	X				Rosethorn Rockfish				
Cabezon	X	X		X	Rosy Rockfish				
Kelp Greenling	X	X		X	Rougheye Rockfish				
Pacific Cod					Sharpchin Rockfish				
Pacific Hake					Shortbelly Rockfish		X		
Sablefish					Shortraker Rockfish				
Aurora Rockfish					Shortspine Thornyhead				
Bank Rockfish					Silverygray Rockfish		X		
Black Rockfish	X	X			Speckled Rockfish		X		
Black-and-Yellow Rockfish	X	X			Splitnose Rockfish		X		
Blackgill Rockfish					Squarespot Rockfish				
Blue Rockfish	X	X			Starry Rockfish				
Bocaccio	X	X		X	Stripetail Rockfish		X		
Bronzespotted Rockfish					Tiger Rockfish				
Brown Rockfish	X	X			Treefish				
Calico Rockfish					Vermilion Rockfish	X	X	X	
California Scorpionfish	X	X			Widow Rockfish		X		
Canary Rockfish		X			Yelloweye Rockfish				
Chilipepper		X	X		Yellowmouth Rockfish				
China Rockfish	X				Yellowtail Rockfish	X	X		
Copper Rockfish	X	X	X		Arrowtooth Flounder				
Cowcod					Butter Sole				
Darkblotched Rockfish					Curlfin Sole				
Dusky Rockfish					Dover Sole				
Flag Rockfish					English Sole	X	X		
Gopher Rockfish	X	X			Flathead Sole				
Grass Rockfish	X	X			Pacific Sanddab	X			
Greenblotched Rockfish					Petrale Sole				
Greenspotted Rockfish					Rex Sole				
Greenstriped Rockfish					Rock Sole				
Harlequin Rockfish					Sand Sole				
Honeycomb Rockfish					Starry Flounder				

Figure 7.5. Species and life stages associated with rooted macrophytes, algae, and seagrasses in estuarine, intertidal, and continental shelf zones.

Source: Table scanned from McCain et al. (2005).

7.7.3 Deep Reefs

Ocean depths are relatively free of large-scale disturbances, allowing sediments to accumulate in large areas, making hard substrate relatively rare (Rex 1981). When hard substrate is available, it can accumulate invertebrates like sponges that enhance the habitat complexity of the rocky reef. These relatively complex deepwater reefs can attract fish populations that differ from those attracted to the surrounding soft-bottom substrate. In surveys conducted on Heceta Bank (Oregon) from a manned submersible, researchers “identified four major habitats and associated benthic macro invertebrate and groundfish assemblages: (1) shallow rock ridges and large boulders (< 100 m deep) dominated by basket stars, juvenile rockfishes, yelloweye rockfish, and lingcod; (2) mid-depth small boulder-cobbles (100-150 m) dominated by crinoids, brittle stars, rosethorn, pygmy/Puget Sound, and canary rockfishes; (3) deep cobble (150-200 m) dominated by crinoids, brittle stars and various small rockfish species; and (4) deep mud slope (> 200 m) dominated by fragile urchins, sea cucumbers, shortspine thornyhead, and flatfishes” (Tissot et al. 2007). Another study (Yoklavich et al. 2000) found larger deep-sea rockfish were associated with high-relief structures (such as walls and caves) and smaller rockfish species were found in low-relief cobble, although it is unknown what part refugia from harvesting played in the size distributions. These studies suggest that deepwater reefs can be productive habitats for fish populations not normally found on soft-bottom habitats at these depths.

7.8 TROPHIC INTERACTIONS

Fish in the Northern Study Area are intricately related to the food they eat and the organisms that consume them. These trophic interactions define the energetic pathways of the marine food web. Numerical models of the Northern Study Area have been constructed to elucidate the interactions of the marine ecosystem by tracing the flow of energy through the food web (Preikshot 2005). The most common of these models are constructed using Ecopath (Pauly et al. 2000) modeling tools and have been used extensively to trace food relationships from lower levels of the food web (primary and secondary producers), to small tertiary consumers (usually small fish), through higher levels of the food web including top predator fish, marine mammals, and birds. Applications of Ecopath models can increase understanding of the impacts of harvest pressure, habitat loss, changes in freshwater flow, and other human activities (Pauly et al. 1998), as well as explain changes in the marine food web due to climate change (Watters et al. 2003).

Top down threats to the marine food web resulting from increased fishing pressure coupled with climate change threaten fish stocks in the Northern Study Area and contribute to destabilizing the entire marine web through creating trophic cascade events that reverberate throughout the ecosystem (Casini 2008). As fisheries agencies come increasingly under pressure to protect fish stocks through ecosystem-based management, the ability to understand trophic relationships has been used extensively to guide effective ecosystem assessments and harvest allocations (Watters et al. 2003).

Marine animals typically prey on organisms that are readily available to them and that make energetic sense to chase down for food. As fish stocks are depleted due to overharvest or changes in climatic conditions, predators prefer to switch prey and exploit other readily available stocks. In the Northern Study Area, this alternative-prey hypothesis indicates that when forage fish are abundant, predatory fish like Pacific hake prey on forage fish rather than on juvenile

salmonids; however, as forage fish stocks decrease, exploitation pressure returns to salmon. Knowledge of the trophic relationships, coupled with predictive tools like numerical models can help explain feeding pressure on depressed salmon stocks in the Northern Study Area (Emmett and Sampson 2007).

7.9 SUMMARY AND DATA GAPS

Fish assemblages in the Northern Study Area are diverse and are affected by a wide range of environmental and human variables including access to marine and freshwater habitat, ocean circulation and upwelling, predation, and commercial and recreational fishing. A number of fish stocks are listed by Federal and State authorities as threatened or endangered.

State and Federal fisheries management agencies carry out annual stock assessments of some species to aid in setting future harvest allocations, or to monitor population levels in response to legally mandated needs to protect declining resources. However, populations of the vast majority of fish in the Northern Study Area are never assessed. In order to determine baselines of fish populations against which to measure future changes, additional broad and frequent monitoring for fish abundance of all species, in all habitats throughout the area, is needed, particularly of those species which are not exploited for commercial or recreational purposes. As [shown in Figures 7.3 through 7.5](#), the fish stocks and species of the Northern Study Area are very diverse; catch and abundance data are generally pooled over large areas, often at the state or regional level. In order to delineate the habitat range or life history of each stock, monitoring data are needed that tie specific species and stocks to smaller home ranges and regions; these data will be needed to answer specific questions that will arise when siting infrastructure in the Northern Study Area. Even less is known about the life history of all but a handful of fish species; data collection that delineates life history, including the location of larvae and juveniles seasonally, is needed for most marine and anadromous species in the region.

A thorough understanding of the prey available to fish populations in the Northern Study Area is needed to determine the stressors that may affect fish populations. Monitoring of prey populations, particularly zooplankton and ichthyoplankton, will help determine what resources higher trophic levels can draw upon. Existing programs such as GLOBEC and CalCOFI could be expanded to focus on fish prey species throughout the Northern Study Area; current efforts are very limited in geographic and seasonal scope.

As climate change effects become more prominent in the coastal and open ocean in coming decades, it will become more difficult to sort impacts on fish stocks due to new activities (such as renewable energy development) from those occurring due to climate change. As a specific example, ocean acidification (Feely et al. 2008) is an emerging issue related to climate change that may have wide-ranging ecosystem effects and may lead to further shifts in climatic regimes, yet we understand little about the impact that lower pH levels will have on fish, their prey, or their habitats. GLOBEC studies in proximity to the Northern Study Area (and limited sampling within the Northern Study Area) begin to address the impacts of climate change on selected fish species and their prey, but are very limited in geographic scope, as well as the species and size range of fish they sample (Peterson and Keister 2002). Similarly efforts to understand changes

in pH in the ocean of the Northern Study Area are needed; expansion of current efforts by NOAA (Feely et al. 2008) are needed.

As fisheries management shifts to an ecosystem-based approach, more data will be needed to understand the interactions between fish species, predators, prey, climate trends, ocean conditions, and human use impacts. Key data needed include the life history, population dynamics, and population trends of fish species of interest and their prey over time, coupled with atmospheric and oceanic measurements of climate change, and effects of human activities in the coastal areas and at sea

With salmon runs continuing to decline throughout the Northern Study Area more information on fish passage and turbine mortality at hydroelectric dams and barriers is needed in order to develop best management practices to mitigate impacts from hydroelectric projects in the study area's major river systems. With demand for electrical power and freshwater irrigation on the rise, it is important to understand the most effective and feasible way to ease pressure on threatened and endangered species. As new plans to generate electricity in the OCS are considered, impacts on salmon and other species will have to be fully considered within the context of impacts from existing electrical resources.

7.10 LIST OF LITERATURE CITED—FISH

- Adams, P.B., C.B. Grimes, J.E. Hightower, S.T. Lindley and M.L. Moser. 2002. Status review for the North American green sturgeon. U.S. Dept. of Commerce, NOAA, National Marine Fisheries Service, Southwest Fisheries Science Center, Santa Cruz, CA. 49 pp.
- Auth, T.D. 2008. Distribution and community structure of *ichthyoplankton* from the northern and central California Current in May 2004-06. *Fisheries Oceanography* 17(4):316-331.
- Bailey, K., R. Francis and P. Stevens. 1982. The life history and fishery of pacific whiting, *Merluccius productus*. CalCOFI Rep. XXIII.
- Bentley, P.J., R.L. Emmett, N.C.H. Lo and H.G. Moser. 1996. Egg production of Pacific sardine (*Sardinops sagax*) off Oregon in 1994. CalCOFI Rep. 37.
- Brodeur, R.D., J.P. Fisher, R.L. Emmett, C.A. Morgan and E. Casillas. 2005. Species composition and community structure of pelagic nekton off Oregon and Washington under variable oceanographic conditions. *Marine Ecology-Progress Series* 298:41-57.
- Brodeur, R.D., W.G. Pearcy and S. Ralston. 2003. Abundance and distribution patterns of nekton and micronekton in the Northern California Current Transition Zone. *Journal of Oceanography* 59(4):515-535.
- California Dept. of Fish and Game. 2009. Final 2007 California commercial landings. Internet website: <http://www.dfg.ca.gov/marine/landings07.asp>. Accessed May 29, 2009.

- Casini, M., J. Lövgren, J. Hjelm, M. Cardinale, J.C. Molinero and G. Kornilovs. 2008. Multi-level trophic cascades in a heavily exploited open marine ecosystem. *Proc Biol Sci.* August 7, 2008. 275(1644):793-801.
- Cordell Bank National Marine Sanctuary. 2009. Natural environment: Biological resources. Internet website: http://cordellbank.noaa.gov/environment/bio_res.html. Accessed May 28, 2009.
- Cross, J.N. and L.G. Allen. 1993. Fishes. In: M.D. Dailey, D.J. Reish and J.W. Anderson. *Ecology of the Southern California bight: A synthesis and interpretation*. Berkley, CA: University of California Press. Pp 369-458.
- Doyle, M.J. 1992. *Neustonic ichthyoplankton* in the northern region of the California current ecosystem. *CalCOFI Rep.* 33:141-161.
- Doyle, M.J., W.W. Morse and A.W. Kendall. 1993. A comparison of larval fish assemblages in the temperate zone of the northeast Pacific and northwest Atlantic Oceans. *Bulletin of Marine Science* 53(2):587-644.
- Emmett, R.L. and R.D. Brodeur. 2000. Recent changes in the pelagic nekton community off Oregon and Washington in relation to some physical oceanographic conditions. *North Pacific Anadromous Fish Commission Bulletin* (2):11-20.
- Emmett, R.L., R.D. Brodeur, T.W. Miller, S.S. Pool, G.K. Krutzikowsky, P.J. Bentley and J. McCrae. 2005. Pacific sardine (*Sardinops sagax*) abundance, distribution, and ecological relationships in the Pacific northwest. *CalCOFI Rep.* 46:122-143.
- Emmett, R.L., G.K. Krutzikowsky and P. Bentley. 2006. Abundance and distribution of pelagic piscivorous fishes in the Columbia River plume during spring/early summer 1997-2003: Relationship to oceanographic conditions, forage fishes, and juvenile salmonids. *Progress in Oceanography* 68(1):1-26.
- Emmett, R.L. and D.B. Sampson. 2007. The relationships between predatory fish, forage fishes, and juvenile salmonid marine survival off the Columbia River: A simple trophic model analysis. *California Cooperative Oceanic Fisheries Investigations Reports* 48:92-105.
- Feely, R.A., C.L. Sabine, J.M. Hernandez-Ayon, D. Ianson and B. Hales. 2008. Evidence for upwelling of corrosive “acidified” water onto the continental shelf. *Science* 320(5882):1490-1492.
- Garrison, T. 1999. *Oceanography: An invitation to marine science*. Belmont, CA: Wadsworth.
- Hickey, B.M. 1979. The California Current System-hypotheses and facts. *Progress in Oceanography* 8:191-279.

- Hobson, E.S. 1994. Ecological relations in the evolution of acanthopterygian fishes in warm temperate communities of the northeastern Pacific. *Environmental Biology of Fishes* 40:49–90.
- Horn, M.H., L.G. Allen and R.N. Lea. 2006. Chapter 1: Biogeography. In: Allen, L.G., D.J. Pondella, and M.H. Horn (eds.). *Ecology of marine fishes: California and adjacent waters*. University of California Press, Berkeley, CA. Pp 3-25.
- Horn, M.H. and L.A. Ferry-Graham. 2006. Chapter 14: Feeding mechanisms and trophic interactions. In: Allen, L.G., D.J. Pondella, and M.H. Horn (eds.). *Ecology of marine fishes: California and adjacent waters*. University of California Press, Berkeley, CA. Pp 387-410.
- Horn, M.H. and K.L.M. Martin. 2006. Chapter eight: Rocky intertidal zone. In: Allen, L.G., D.J. Pondella, and M.H. Horn (eds.). *Ecology of marine fishes: California and adjacent waters*. University of California Press, Berkeley, CA. Pp 205-226.
- Iwamoto, E., M.J. Ford and R.G. Gustafson. 2004. Genetic population structure of Pacific hake, *Merluccius productus*, in the Pacific Northwest. *Environmental Biology of Fishes* 69(1-4):187-199.
- Jay, C.V. 1996. Distribution of bottom-trawl fish assemblages over the continental shelf and upper slope of the U.S. West Coast, 1977-1992. *Canadian Journal of Fisheries and Aquatic Sciences* 53(6):1203-1225.
- Joint Institute for the Study of the Atmosphere and Ocean (JISAO). 2000. The pacific decadal oscillation (PDO). Internet website: <http://jisao.washington.edu/pdo/>. Accessed May 28, 2009.
- Koslow, J.A., G. W. Boehlert, J. D. M. Gordon, R. L. Haedrich, P. Lorange and N. Parin. 2000. Continental slope and deep-sea fisheries: implications for a fragile ecosystem. *ICES Journal of Marine Science: Journal du Conseil*. 57(3):548-557; doi:10.1006/jmsc.2000.0722
- Krutzikowsky, G.K. and R.L. Emmett. 2005. Diel differences in surface trawl fish catches off Oregon and Washington. *Fisheries Research* 71(3):365-371.
- Levin, P.S. 2000. Habitat structure, conspecific presence and spatial variation in the recruitment of a temperate reef fish. *Oecologia*. 94(2): 176-185.
- Levin, P. S. 1993. Habitat structure, conspecific presence and spatial variation in the recruitment of a temperate reef fish. *Oecologia* 94: 176-185.
- Lynn, R.J. 2003. Variability in the spawning habitat of Pacific sardine off southern and central California. *Fisheries Oceanography* 12(6):541-553.
- McCain, B.B., S.D. Miller and W.W. Wadefield. 2005. Life history, geographical distribution, and habitat associations of 82 West Coast Groundfish species: A literature review. In:

Pacific Coast Groundfish Fishery Management Plan Essential Fish Habitat Designation and Minimization of Adverse Impact Draft Environmental Impact Statement.

- McClatchie, S., R. Goericke, J.A. Koslow, F.B. Schwing, S.J. Bograd, R. Charter, W. Watson, N. Lo, K. Hill, J. Gottschalck, M. L'Heureux, Y. Xue, W.T. Peterson, R. Emmett, C. Collins, G. Gaxiola-Castro, R. Durazo, M. Kahru, B.G. Mitchell, K.D. Hyrenbach, W.J. Sydeman, R.W. Bradley, P. Warzybok and E. Bjorkstedt. 2008. The state of the California Current, 2007-2008: La Nina conditions and their effects on the ecosystem. California Cooperative Oceanic Fisheries Investigations (CalCOFI) Reports 49:39-76.
- Moser, H.G., R.L. Charter, P.E. Smith, N.C.H. Lo, D.A. Ambrose, C.A. Meyer, E.M. Sandknop and W. Watson. 1994. Early-life history of sablefish *anoplopoma-fimbria*, off Washington, Oregon, and California with application to biomass estimation. California Cooperative Oceanic Fisheries Investigations Reports 35:144-159.
- Pacific Fishery Management Council (PFMC). 2008. Pacific Coast groundfish fishery management plan for the California, Oregon, and Washington groundfish fishery: As amended through Amendment 19.
- Pacific Fishery Management Council (PFMC). 2009a. Fishery management: Groundfish. Internet website: <http://www.pcouncil.org/groundfish/gfprimer.html>. Accessed May 29, 2009.
- Pacific Fishery Management Council (PFMC). 2009b. Fishery Management: Coastal pelagic species. Internet website: <http://www.pcouncil.org/cps/cpsback.html>. Accessed May 29, 2009.
- Pacific Fishery Management Council (PFMC). 2009c. Fishery Management: Pacific halibut. Internet website: <http://www.pcouncil.org/halibut/halback.html>. Accessed May 29, 2009.
- Pauly, D., V. Christensen, J. Dalsgaard, R. Froese and F. Torres Jr. 1998. Fishing down marine food webs. *Science* 279(5352):860-863.
- Pauly, D., V. Christensen and C. Walters. 2000. Ecopath, Ecosim, and Ecospace as tools for evaluating ecosystem impact of fisheries. *ICES Journal of Marine Science: Journal du Conseil* 57(3):697-706; doi:10.1006/jmsc.2000.0726
- Peterson, W.T. and J.E. Keister. 2002. The effect of a large cape on distribution patterns of coastal and oceanic copepods off Oregon and Northern California during the 1998–1999 El Niño–La Niña. *Progress in Oceanography* 53(2-4): 389-411.
- Preikshot, D. 2005. Data sources and derivation of parameters for generalised Northeast Pacific Ocean Ecopath with Ecosim models. In: Guénette, S. and V. Christensen (eds.). 2005. Food web models and data for studying fisheries and environmental impacts on Eastern Pacific ecosystems. Fisheries Centre Research Reports 13(1):179-206.

- Rex, M.A. 1981. Community structure in the deep-sea benthos. *Annual Review of Ecology and Systematics* 12:331-353.
- Saunders, M.W. 1997. Observations on the spawning distribution and biology of offshore Pacific hake *Merluccius productus*. *CalCOFI Rep.* 38:147-157. Observations on the spawning distribution and biology of offshore Pacific hake *Merluccius productus*.
- Smith, K.F. and J.H. Brown. 2002. Patterns of diversity, depth range and body size among pelagic fishes along a gradient of depth. *Global Ecology and Biogeography* 11(4):313-322.
- State of California. 2009. State of Emergency - Chinook Salmon Proclamation. Office of the Governor, Sacramento CA. Internet website <http://gov.ca.gov/proclamation/12083>. Accessed July 8, 2009.
- Stephens, Jr., J.S., R.J. Larson, and D.J. Pondella. 2006. Chapter 9: Rocky Reefs and Kelp Beds. In: Allen, L.G., D.J. Pondella and M.H. Horn (eds.). *Ecology of marine fishes: California and adjacent waters*. University of California Press, Berkeley, CA. Pp 227-252.
- Sweetman, D., D. Aseltine-Neilson, K. Barsky, M. Connell, J. Heisdorff, P. Kalvass, J. Mello, K. O'Reilly, V. Taylor, S. Wertz and D. Wilson-Vandenberg, Calif. Dept. of Fish and Game. 2005. Review of some California fisheries for 2004: Coastal pelagic finfish, market squid, sea urchin, lobster, spot and ridgeback prawn, groundfish, highly migratory species, ocean salmon, nearshore live-fish, Pacific herring, and recreational. *California Cooperative Oceanic Fisheries Investigations Reports* 46:10-31.
- Tissot, B.N., M.A. Hixon and D.L. Stein. 2007. Habitat-based submersible assessment of macro-invertebrate and groundfish assemblages at Heceta Bank, Oregon, from 1988 to 1990. *Journal of Experimental Marine Biology and Ecology* 352(1):50-64.
- Tolimieri, N. and P.S. Levin. 2006. Assemblage structure of eastern pacific groundfishes on the U.S. continental slope in relation to physical and environmental variables. *Transactions of the American Fisheries Society* 135(2):317-332.
- U.S. Dept. of Commerce, National Marine Fisheries Service (NMFS). 2009a. FishWatch, fact sheet for Dover sole. Internet website: http://www.nmfs.noaa.gov/fishwatch/species/dover_sole.htm. Accessed May 28, 2009.
- U.S. Dept. of Commerce, National Marine Fisheries Service (NMFS). 2009b. Commercial Fishery Landings. Internet website: <http://www.st.nmfs.noaa.gov/st1/commercial/>. Accessed May 29, 2009.
- U.S. Dept. of the Interior, Minerals Management Service (MMS). 2007. Programmatic environmental impact statement for alternative energy development and production and alternate used of facilities on the outer continental shelf, Volume I: Executive Summary through Chapter 4. U.S. Dept. of the Interior, Minerals Management Service. OCS EIS/EA 2007-046.

- Washington Dept. of Fish and Wildlife. 2009. Summary of Washington Pacific halibut fisheries management in 2008. Internet website: <http://wdfw.wa.gov/fish/creel/halibut/2008halibut.htm>. Accessed on May 1, 2009.
- Watters, G.M., R.J. Olson, R.C. Francis, P.C. Fiedler, J.J. Polovina, S.B. Reilly, K.Y. Aydin, C.H. Boggs, T.E. Essington, C.J. Walters and J.F. Kitchell. 2003. Physical forcing and the dynamics of the pelagic ecosystem in the eastern tropical Pacific: Simulations with ENSO-scale and global-warming climate drivers. *Can. J. Fish. Aquat. Sci.* *60*:1161-1175.
- Yoklavich, M.M., H.G. Greene, G.M. Cailliet, D.E. Sullivan, R.N. Lea and M.S. Love. 2000. Habitat associations of deepwater rockfishes in a submarine canyon: An example of a natural refuge. *Fishery Bulletin* *98*(3):625-641.
- Yoshiyama, R.M. and J.J. Cech. 1994. Aerial respiration by rocky intertidal fishes of California and Oregon. *Copeia*(1):153-158.

8. SEA TURTLES

Sea turtles inhabit tropical and subtropical seas and are relatively uncommon in northeastern Pacific waters north of Mexico. Historically, four species of sea turtles have been recorded in the northeastern Pacific: the green sea turtle (*Chelonia mydas*), the leatherback sea turtle (*Dermochelys coriacea*), the loggerhead sea turtle (*Caretta caretta*), and the Pacific (or olive) ridley sea turtle (*Lepidochelys olivacea*) (USDOC, NMFS & USDO, USFWS 1998a, b, c, d). Sea turtle populations have been greatly reduced by overharvesting, fishery by-catch, disease, pollution, and coastal development of nesting beaches (Lewison and Crowder 2007). All species of sea turtles are listed as either threatened or endangered (Table 8.1) and trade is restricted by the Convention on International Trade in Endangered Species (CITES); however, not all countries adhere to a no-take policy and harvesting continues to be a threat to these species.

Table 8.1.

Conservation status of all species of sea turtles found in the Northern Study Area

Species	Federal Listing	Washington Listing	Oregon Listing	California Listing
Green Sea Turtle <i>Chelonia mydas</i>	Threatened; breeding Mexico (Pacific) population endangered	Threatened	Endangered	none
Leatherback Sea Turtle <i>Dermochelys coriacea</i>	Endangered	Endangered	Endangered	none
Loggerhead Sea Turtle <i>Caretta caretta</i>	Threatened	Threatened	Threatened	none
Olive Ridley Sea Turtle <i>Lepidochelys olivacea</i>	Threatened; Mexico (Pacific) population Endangered	none	Threatened	none

Source: CA DFG 2009; OR DFW 2009; WA DFW 2009

Green sea turtles, also known as black sea turtles, are found worldwide in waters that remain above 20° C year-round. In the Pacific, green turtles are federally listed as threatened, except for Mexican breeding populations, which are listed as endangered (USDOC, NMFS & USDOC, USFWS 2007a). These populations are reported to be stable or increasing from the population low during the mid 1980s to 1990s (USDOC, NMFS & USDO, USFWS 2007a). While there are no known foraging or nesting locations for this species within this regional study area these are highly mobile individuals that could occur rarely in the Northern Study Area.

Leatherback sea turtles, the largest of the sea turtles, occur in the Atlantic, Indian, and Pacific Oceans (USDOC, NMFS & USDO, USFWS 2007b). Leatherbacks commonly range farther north than other sea turtles, probably because of their ability to maintain warmer body temperatures over longer time periods (USDOC, NMFS 2009), and they have been sighted in the eastern North Pacific as far north as Alaska (USDOC, NMFS & USDO, USFWS 2007b). Despite being federally listed as endangered in 1970, leatherbacks are the most common sea turtle in U.S. West Coast waters (USDOC, NMFS & USDO, USFWS 2007b). However, many of these sightings are reports of entanglement in commercial fishing gear off Washington, Oregon, and California (USDOC, NMFS & USDO, USFWS 2007b). This concern over the rate of by-catch was voiced in a petition to U.S. Dept. of Commerce, National Marine Fisheries

Service (NMFS) requesting new designation of critical habitat for this species along the entire West Coast of the U.S. (USDOC, NMFS 2009). A critical habitat review was completed by NMFS and the proposed locations are currently out for public comment (75 FR 319). Other threats to this species include degradation of nesting habitats; estimates of nesting females at beaches in the eastern Pacific vary widely but show that populations have been declining rapidly. Beaches that were visited by over 1,300 females in the late 1980s were visited by less than 200 in the early 2000s (USDOC, NMFS & USDO, USFWS 2007b).

Loggerhead sea turtles inhabit subtropical to temperate waters worldwide, and are generally found in waters over the continental shelf. In the Pacific, loggerheads nest only in the western region, primarily at and near Japan and Australia (USDOC, NMFS & USDO, USFWS 2007c). Sightings from the West Coast of the United States are primarily of juveniles seen within the Southern California Bight, although a few sightings have been reported in Washington and Alaska (USDOC, NMFS & USDO, USFWS 2007c). The loggerhead was federally listed as threatened in 1978 and nesting populations have not been monitored with enough frequency to conclude a long-term trend (USDOC, NMFS & USDO, USFWS 2007c).

Pacific, or olive, ridley sea turtles are the smallest of the sea turtles. Olive ridleys occur worldwide in tropical to warm temperate waters and are considered to be the most abundant sea turtle in the world (USDOC, NMFS & USDO, USFWS 2007d). The species was federally listed in 1978; Pacific ridleys on the Pacific Coast of Mexico are listed as endangered, all other populations as threatened. The at-sea estimate of the population in the eastern Pacific is 1.39 million (USDOC, NMFS & USDO, USFWS 2007d). In the eastern Pacific, the species' main foraging areas extend to the south between Mexico and Colombia and these turtles are infrequent visitors to waters north of Mexico. While there are no known foraging or nesting locations for this species within this regional study area these are highly mobile individuals that could occur rarely in the Northern Study Area.

8.1 MIGRATION

Of the two species of sea turtles found in the study area, one exhibits an oceanic-neritic developmental pattern and the other is believed to remain solely in oceanic habitats. Loggerhead turtles migrate to oceanic foraging grounds as hatchlings and remain there during their juvenile development stage. They then return to neritic (nearshore) habitats as late-stage juveniles and finish their development. As adults loggerheads remain in neritic foraging grounds, where they feed primarily on benthic organisms (Lutz et al. 2003). While little is known about their migratory patterns, leatherback turtles are believed to develop in oceanic waters and maintain their pelagic nature as adults (Lutz et al. 2003). Recent studies suggest that these species may spend more time in neritic waters than previously thought as they forage for food (reviewed in USDOC, NMFS 2009).

As adults, sea turtles migrate between foraging grounds and nesting beaches. Natal site fidelity is strong among all species and breeding-associated migration occurs every one to five years depending on the species (Lutz et al. 2003). Many individuals have been tagged and followed on circumglobal routes between nesting and foraging locations, which can be hundreds to thousands of kilometers apart (Luschi et al. 2003). The West Coast of the Americas is a common place to

find sea turtles. All four species found in the eastern Pacific nest on the tropical coasts and forage to the north and south. In the northern hemisphere, the summer upwelling off Northern California and Oregon draws turtles to feed on the seasonal productivity. Loggerheads and leatherbacks have been observed as far north as British Columbia and Alaska (USDOC, NMFS & USDO, USFWS 1998b, c; USDOC, NMFS 2009). This creates a migration corridor along the entire length of North America.

8.2 FORAGING

All species of sea turtles are omnivorous and major food items often depend on seasonality and preferred foraging ranges. Species that spend more time in neritic waters feed on benthic organisms, whereas species that are more oceanic feed primarily on pelagic prey items. Across the Pacific basin leatherback and loggerheads are known to migrate from breeding grounds in the west to feeding grounds in the east (Shester 2007; USDOC, NMFS 2009). This migration allows the turtles to take advantage of seasonal upwelling and the increased productivity of the eastern boundary currents. Specifically, aggregations of jellyfish (*Chrysaora* spp) off Northern California and Oregon attract leatherbacks, which flock to the area in the autumn months (Peterson et al. 2006; USDOC, NMFS 2009). This seasonal food source has been shown to be such an important resource for leatherbacks that it has resulted in the proposed designation of critical habitat in these areas (USDOC, NMFS 2009; 75 FR 319).

Although considered omnivorous (feeding on sea urchins, crustaceans, fish, and floating seaweed), leatherbacks feed principally on soft foods such as cnidarians (medusae, siphonophores) and tunicates (salps, pyrosomas) (Lutz and Musick 1997; USDOC, NMFS & USDO, USFWS 1998b). Leatherbacks also may forage nocturnally at depth on siphonophores and salps in the deep scattering layer (USDOC, NMFS & USDO, USFWS 1998b).

Loggerhead sea turtles are omnivorous, feeding on a variety of benthic prey including shellfish, crabs, barnacles, oysters, jellyfish, squid, sea urchins, and occasionally on fish, algae, and seaweed (Lutz and Musick 1997; USDOC, NMFS & USDO, USFWS 1998c; Boyle and Limpus 2008).

8.3 NESTING

In the northeastern Pacific, most sea turtles nest on the Pacific Coasts of Mexico and Central America. The age at which sea turtles reach sexual maturity varies considerably between and within species, ranging from as few as several years to as long as two decades (Shigenaka 2003). They breed at sea, and the females instinctively return to their natal beaches to lay eggs (although leatherbacks are not such strict remigrators). Females typically nest one to ten times during the nesting season (again depending upon the species), with clutch sizes of 80 to 150 eggs. About two months after being laid in the sand, eggs hatch, and the young instinctively make for the sea (Shigenaka 2003). Once at sea the males very rarely, if ever, return to land. There are no known nesting locations in the coastal environment between Grays Harbor, WA and San Francisco Bay, CA.

8.4 BY-CATCH

The decline in the world's populations of sea turtles has been documented primarily as the declining numbers of nests. These declines are due to many factors including harvesting, development of coastal nesting sites, and by-catch in fishing gear. Since all species of sea turtles are now considered threatened or endangered, the harvesting has mostly ceased; however, the development of coastal habitats and by-catch are important factors that continue to negatively impact these populations.

On the coast of California north of Point Sur, the gillnet fishery for swordfish and thrasher shark is closed August through November to protect loggerhead turtles that might be in the area (Carretta et al. 2005). Unfortunately, this only acts to concentrate the fishing effort in the southern region, where presumably turtles are also found as they migrate south for warmer waters in the winter. Carretta et al. (2005) estimated that over 700 turtles were killed by the gillnet fishery between 1996 and 2002. This is of particular concern since populations have been rapidly declining in recent years. Another study focusing on the effects of the longline fishery on the Pacific populations of leatherbacks found this fishery caused five percent annual mortality (Kaplan 2005). While this may not appear to be a large component to mortality, this fishery is believed to affect older, more reproductively important individuals, whose health and survival are more important to the population than younger individuals (Lewison and Crowder 2007).

These and other fisheries contribute to the decline of these sensitive populations; leatherbacks, the most common species in West Coast U.S. waters, were estimated at less than 1,700 individuals in 2000 (Spotila et al. 2000). A recently proposed rule by the National Marine Fisheries Service (NMFS) would designate a large portion of the West Coast of the U.S. as critical habitat for this species (75 FR 319). The proposed areas within the Northern Study Area include nearshore and offshore areas from San Francisco Bay north to Point Arena, CA and from the Umpqua River outflow in Oregon to Cape Flattery at the northern point of the Olympic Peninsula in Washington. These areas were chosen because they are where the major aggregations of jellyfish arise in the late summer and fall months, which are a major food source for leatherbacks (Peterson et al. 2006; USDOC, NMFS 2009). If these areas become part of the final designation of critical habitat, it would require federal agencies to consult with NMFS on actions they take that could cause destruction or adverse modification to this habitat (16 U.S.C §1536).

8.5 SUMMARY AND DATA GAPS

Sea turtles are infrequent in the waters off the coasts of Washington, Oregon, and Northern California; however, they are not absent. The seasonal presence of species feeding on increased food productivity is an important part of the biology of these animals. The future success of these populations depends on protection at all life stages, and protection from commercial fishing is an important step in this region. In order to support protection efforts in the Northern Study Area, potential alternative energy projects need to evaluate the seasonal use of the Outer Continental Shelf by these threatened and endangered populations when choosing locations and type of installation.

While much more information about these long-lived species is becoming available with the advancement of satellite-telemetry technology, little remains known about their post-hatchling stages. Additionally, comprehensive population estimates are hard to compile because of the solitary nature and wide distribution of individuals.

8.6 LIST OF LITERATURE CITED—SEA TURTLES

- Boyle, M. and C. Limpus. 2008. The stomach contents of post-hatchling green and loggerhead sea turtles in the southwest Pacific: an insight into habitat association. *Marine Biology* 155 (2): 233-241.
- California Dept. of Fish and Game (CA DFG). 2009. State and federally listed endangered and threatened animals of California. Internet Website: <http://www.dfg.ca.gov/biogeodata/cnddb/pdfs/TEAnimals.pdf>. Accessed June 2009.
- Carretta, J., T. Price, D. Petersen and R. Read. 2005. Estimates of Marine Mammal, Sea Turtle, and Seabird Mortality in the California Drift Gillnet Fishery for Swordfish and Thresher Shark, 1996-2002. *Marine Fishery Review* 66 (2): 21-30. 21.
- Kaplan, I. C. 2005. A risk assessment for Pacific Leatherback Turtles (*Dermochelys coriacea*). *Conservation Biology* 62: 1710-1719.
- Lewison, R. L. and L. B. Crowder. 2007. Putting longline bycatch of Sea Turtles into perspective. *Conservation Biology* 21 (1): 79 - 86.
- Luschi, P., G.C. Hays and F. Papi. 2003. A review of long-distance movements by marine turtles, and the possible role of ocean currents. *Oikos* 103 (2): 293 - 302.
- Lutz, P. and J. Musick. 1997. *Biology of Sea Turtles*. Boca Raton: CRC Press.
- Lutz, P., J. Musick and J. Wynken. 2003. *Biology of Sea Turtles Volume II*. Boca Raton: CRC Press.
- Oregon Dept. of Fish and Wildlife (OR DFW). 2009. Threatened, Endangered, and Candidate Fish and Wildlife Species in Oregon. Internet website: http://www.dfw.state.or.us/wildlife/diversity/species/docs/Threatened_and_Endangered_Species.pdf. Accessed June 2009.
- Peterson, B., R. Emmett, R. Goericke, E. Venrick, A. Mantyla, S. J. Bograd, F. B. Schwing, S. Ralston, K. A. Forney, R. Hewitt, N. Lo, W. Watson, J. Barlow, M. Lowry, B. E. Lavaniegos, F. Chavez, W. J. Sydeman, D. Hyrenbach, R. W. Bradley, P. Warzybok, K. Hunter, S. Benson, M. Weise and J. Harvey. 2006. The state of the California current, 2005-2006: Warm in the North, cool in the South. *California Cooperative Oceanic Fisheries (CalCOFI) Investigations Reports* 47: 30-74.
- Shester, G. 2007. Forging a Future for Pacific Sea Turtles. In: *Oceana*. Monterey, California.

- Shigenaka, G. 2003. Oil and Sea Turtles: Biology, Planning, and Response. U.S. Dept. of Commerce, National Oceanic and Atmospheric Administration NOAA's National Ocean Service, Office of Response and Restoration.
- Spotila, J., R. Reina, A. Steyermark, P. Plotkin and F. Paladino. 2000. Pacific leatherback turtles face extinction. *Nature* 405 (6786): 529-530.
- U.S. Dept of Commerce, National Oceanic and Atmospheric Administration, National Marine Fisheries Service (NMFS). 2009. Revision of Critical Habitat for Leatherback Sea Turtles: Biological Report. National Marine Fisheries Service, Office of Protected Resources: November 2009.
- U.S. Dept. of Commerce, National Oceanic and Atmospheric Administration, National Marine Fisheries Service (NMFS) and U.S. Department of Interior, U.S. Fish and Wildlife Service. (USFWS). 1998a. Recovery Plan for U.S. Pacific Population of the East Pacific Green Turtle (*Chelonia mydas*).
- U.S. Dept. of Commerce, National Marine Fisheries Service (NMFS) and U.S. Dept. of Interior, Fish and Wildlife Service (USFWS). 1998b. Recovery Plan for U.S. Pacific Population of the Leatherback Turtle (*Dermochelys coriacea*).
- U.S. Dept. of Commerce, National Marine Fisheries Service (NMFS) and U.S. Dept. of Interior, Fish and Wildlife Service (USFWS). 1998c. Recovery Plan for U.S. Pacific Population of the Loggerhead Turtle (*Caretta caratta*).
- U.S. Dept. of Commerce, National Marine Fisheries Service (NMFS) and U.S. Dept of Interior, Fish and Wildlife Service (USFWS). 1998d. Recovery Plan for U.S. Pacific Population of the Olive Ridley Turtle (*Lepidochelys olivacea*).
- U.S. Dept. of Commerce, National Marine Fisheries Service (NMFS) and U.S. Dept. of Interior, Fish and Wildlife Service (USFWS). 2007a. Five year Review of Green Turtles.
- U.S. Dept of Commerce, National Marine Fisheries Service (NMFS) and U.S. Dept. of Interior, Fish and Wildlife Service (USFWS). 2007b. Five year Review of Leatherback Turtles.
- U.S. Dept. of Commerce, National Marine Fisheries Service (NMFS) and U.S. Dept. of Interior, Fish and Wildlife Service (USFWS). 2007c. Five year Review of Loggerhead Turtles.
- U.S. Dept of Commerce, National Marine Fisheries Service (NMFS) and U.S. Dept. of Interior, Fish and Wildlife Service (USFWS). 2007d. Five year Review of Olive Ridley Turtles.
- Washington Dept. of Fish and Wildlife (WA DFW). 2009. Species of Concern in Washington State. Internet website: <http://wdfw.wa.gov/wlm/diversty/soc/soc.htm>. Accessed June 2009.

9. BIRDS

Extensive research and monitoring was conducted in the coastal region of the Northern Study Area during the 1960s and 1970s. The description and review prepared in 1977 for the Bureau of Land Management provided details of habitats and lists of species of marine birds (Oceanographic Institute of Washington and Human Resources Planning Institute 1977) for the Washington and Oregon Coasts, with some emphasis on Northern California. This chapter will focus on the portions of the Northern Study Area not well covered by the 1977 report as well as on studies that have examined the bird species and their habitats from a new perspective.

9.1 DISTRIBUTION AND ABUNDANCE

9.1.1 Habitats

Habitats exploited by birds within the Northern Study Area are diverse and include those found in the open ocean as well as at the land-sea interface. Birds use the open ocean for foraging and their association with the open ocean is dictated by the presence and abundance of aquatic organisms as food. Birds are highly mobile and are able to cover vast areas in search of food; the availability of forage is influenced by many factors including currents, upwelling, estuaries, and wind (Ainley et al. 2005; Hashmi and Causey 2008; Vlietstra 2005). The California Current System (CCS), and its associated fronts and eddies, has been identified as a key ingredient in forage availability and productivity in many seabird species (Ainley et al. 2005; Hyrenbach and Veit 2003; Hyrenback et al. 2006; Yen et al. 2006). Hundreds of thousands of breeding seabirds are dependent upon food resources made available by this system (Lee et al. 2007; Parrish et al. 2007; Sydeman et al. 2001; Thayer and Sydeman 2007; Veit et al. 1996; Wilson 2005).

The land-sea interface, including coastal habitats and islands, provides resources vital to the survival of many bird species. Coastlines form the interface between ocean and continent, are longitudinal in nature, diverse in structure and function, and provide a mosaic of bird habitats (Burger 1991). Habitats, such as offshore rocks, cliffs, bluffs, beaches, dunes, grasslands, tideflats, mudflats, salt marshes, estuarine wetlands, coastal scrub, and even old-growth forest, provide birds with nest sites, forage, and security from predators. This mosaic of habitat diversity, coupled with the forage provided by ocean waters, serves to concentrate birds along the coast. In recognition of the value of these lands to birds, many National Wildlife Refuges (NWR) have been established along the Pacific Coast from Grays Harbor, Washington, to San Francisco Bay ([Table 9.1](#)).

Table 9.1.

National Wildlife Refuges found along the Pacific Coast between Grays Harbor, WA and San Francisco Bay.

National Wildlife Refuge Name	Primary Function
Grays Harbor	Major staging area for up to 1 million shorebirds.
Willapa	Pristine estuary supports seabirds in summer and fall.
Cape Mears	Cliffs where thousands of seabirds nest.
Three Arch Rocks	Offshore rocks with 15 seabird species nesting (200,000 common murre).
Nestucca Bay	Short grass pasture for Dusky and Aleutian Canada geese.
Siletz Bay	Estuary for brown pelicans, waterfowl, and shorebirds.
Brandon Marsh	Mudflats for migrant waterfowl, shorebirds, and wading birds.
Oregon Islands	Thousands of islands along coast support 1.2 million nesting seabirds, brown pelicans, and Aleutian Canada geese.
Castle Rock	Coastal rocks supporting up to 150,000 nesting seabirds and 21,000 roosting Aleutian Canada geese.
Humboldt Bay	Vast wetlands serve as stopover for migratory shorebirds and waterfowl.
San Pablo Bay	Tidal wetlands support migrant shorebirds and waterfowl (especially diving ducks).
Marin Islands	Large rookery of egrets and herons.
Farallon	Largest nesting seabird colony south of Alaska. About 250,000 of 13 seabird species nest annually.
*Flattery Rocks, Quillayute Needles, Copalis	Hundreds of islands along 100 miles of coastline support 200,000 breeding seabirds (70 percent of WA population), including 14 species and >1/2 of West Coast fork-tailed storm-petrels.

*Located north of Grays Harbor, WA

The coastal islands within the Oregon Islands National Wildlife Refuge (NWR) and Farallon NWR serve as major nesting grounds for seabirds along the Pacific Coast. The islands within the Farallon NWR constitute the largest seabird breeding colony south of Alaska (USDOJ, USFWS 2009a). Although not within the area of interest, immediately north of Grays Harbor is a series of refuges similar to the Oregon Islands NWR that supports 70 percent of all breeding seabirds found in Washington. Due to the relative proximity to the study area, many of the seabirds that breed within these refuges are likely found along the Outer Continental Shelf (OCS) during nonbreeding seasons.

Habitat present in the many bays, including protected areas in Grays Harbor and Humboldt Bay, are typically lowlands that support migratory seabirds, shorebirds, and waterfowl during spring and fall. These beaches, mudflats, and tidelands function as important stopover sites for shorebirds that breed further north and migrate along the coast (Warnock and Bishop 1998). Little data exist to document use of coastal habitats during winter. However, there is some indication that coastal beaches may also support some shorebird species during this season (Colwell and Sundeen 2000).

Habitats utilized by bird life along the OCS of Washington, Oregon, and Northern California are dynamic and diverse in nature. These habitats provide nesting, roosting, security, and food

resources for millions of birds annually. The NWRs have been established to protect land-based resources where large concentrations of birds occur; however, these protections do not extend to open-water areas that supply the forage necessary to sustain these bird populations.

9.1.2 Marshbirds

The term marshbird broadly encompasses birds that feed, nest, or otherwise utilize tidal or freshwater marshes. In the Northern Study Area, resident marshbird species include the great blue heron (*Ardea herodias*), snowy egret (*Egretta thula*), great egret (*Ardea alba*), red-winged blackbird (*Agelaius phoeniceus*), and Virginia rail (*Rallus limicola*) (see Oceanographic Institute of Washington and Human Resources Planning Institute 1977 Table V-51 for a complete species list). Marshbirds typically nest upland of the Northern Study Area and may forage in estuarine and shoreline environments, such as those found in Grays Harbor, Willapa Bay, the Columbia River Estuary, Humboldt Bay, Tomales Bay, and San Francisco Bay (Fleskes and Yee 2007).

Great blue herons are found along the shorelines, bays, and estuaries of the Northern Study Area year round. Herons typically breed in colonies, nesting in evergreen and deciduous trees near fresh- and saltwater marshes or estuaries from mid-February to the end of July. Great blue herons may forage up to 29 km from nesting colonies, but typical forage distances range from 2 to 5 km (Quinn and Milner 2004). These birds are generally sensitive to human disturbance and nesting sites are often abandoned due to land development, wetland loss, logging, and human intrusions (Quinn and Milner 2004).

The Virginia rail breeds in freshwater marshes inland of the Northern Study Area, but utilizes shallow marine waters as foraging habitat. The same is true for the snowy egret, which breeds in Northern California, and the great egret, which breeds in southern Oregon and California. The red-winged blackbird is a permanent resident of the brackish and freshwater marshes of Washington, Oregon, and California, although it may withdraw south from its northern breeding range in the winter, returning in February or March.

9.1.3 Waterbirds

Generally, waterbirds are present along the protected shores, bays, and estuaries of the Northern Study Area in their largest numbers in winter, migrating north or east outside of the study area to breed in the summer. Waterbird species that utilize the marine and estuarine waters of the Northern Study Area include: black brant (*Branta bernicla*), trumpeter swan (*Cygnus buccinator*), tundra swan (*Cygnus columbianus*), wood duck (*Aix sponsa*), Barrow's goldeneye (*Bucephala islandica*), common goldeneye (*Bucephala clangula*), hooded merganser (*Lophodytes cucullatus*), bufflehead (*Bucephala albeola*), American widgeon (*Anas americana*), northern pintail (*Anas acuta*), and the harlequin duck (*Histrionicus histrionicus*) (see Oceanographic Institute of Washington and Human Resources Planning Institute 1977 Table V-51 for a complete species list).

In Southern Washington, Willapa Bay is an important stopover for wintering black brant, migrating from breeding grounds in the far north to wintering areas further south in California and Mexico (Willapa NWR 2009). Black brant arrive on the shores of the Northern Study Area via the open ocean.

The lower Columbia River estuary in Washington and Oregon provides habitat for nonbreeding resident trumpeter swans, tundra swans, and wintering wood ducks. Populations of Barrow's goldeneye, common goldeneye, hooded merganser, and bufflehead also overwinter in the estuaries and marine waters of southern Washington and northern Oregon (Lewis and Kraege 2004).

The harlequin duck breeds in the mountains of Western Washington and Northern Oregon and overwinters along the Pacific Coast (Lewis and Kraege 2004). Most harlequins occur less than 50 m from the shore, preferring gravel or rocky substrate and kelp beds, where they forage on crustaceans, mollusks, and aquatic insects.

San Francisco Bay estuary is a migration and wintering ground for more than 1.5 million waterbirds (Takekawa et al. 2002). The Klamath Basin in southern Oregon and the Sacramento Valley in Northern California support enormous populations of waterfowl during the spring migration, with an average of 1.075 million birds staging there on their way north along the Pacific Flyway ([Figure 9.1](#)) (Fleskes and Yee 2007).

9.1.4 Shorebirds

In the United States, the term shorebird is commonly applied to a group of 50 species of sandpipers, plovers, oystercatchers, avocets, and stilts (Brown et al. 2001). Shorebird life histories are defined by remarkably long migrations between wintering and breeding grounds, often measured in thousands of miles (Brown et al. 2001). Shorebirds are most likely to enter the Northern Study Area while migrating from Arctic breeding grounds in the fall and again on their return journey from southern wintering grounds in the spring. On both the southern and northern migration, they must stop to rest and refuel (Warnock and Bishop 1998); it is during these stops that most shorebird species are observed along the coasts of Washington, Oregon, and California. Most often, coastal estuaries and wetlands are utilized during migratory stopovers as they provide high densities of food during the migratory time frame (Brown et al. 2001).

Because suitable stopover habitats are often widely dispersed, very large shorebird concentrations—sometimes numbering in the millions—occur during peak migration (Brown et al. 2001). Warnock et al. (2004) radio-marked and relocated dunlin (*Calidris alpina*) in San Francisco Bay and Grays Harbor during their spring migration along the 4200-km stretch of coastline between San Francisco and the Yukon Delta. They found that the wetland complex of Grays Harbor and Willapa Bay was the second most important stopover site (behind the Copper River Delta, AK) with additional sites in the Northern Study Area recorded in Newport Bay and Humboldt Bay. Dunlin also occur in large numbers on the Oregon coast at Bandon Marsh and Coos Bay (Warnock et al. 2004).

Warnock et al. (2004) determined that dunlin and western sandpipers follow the coastline during the spring migration to northern breeding grounds, making a series of short stops (on average 1.0 to 3.8 days). This spring movement is in contrast to the fall migration, during which dunlin are

known to stage in western Alaska until October and then fly nonstop over the Gulf of Alaska to the Pacific Northwest and points south (Warnock et al. 2004).

At least 16 shorebird species regularly occur within suitable habitats along the Pacific Coastline of Washington, Oregon, and Northern California (Table 9.2). Coastal development and human activities in coastal zones have degraded or eliminated stopover habitat; protection and preservation have become conservation issues.

The Western snowy plover (*Charadrius alexandrinus nivosus*) breeds on the sandy beaches of all three states in the Northern Study Area. There are only 1,800 breeding pairs of snowy plovers between Damon Point, Washington and Baja, California and the species was federally listed as threatened in 1993 (Point Reyes National Seashore 2009). Breeding season is from March to September on sandy beaches. The American avocet (*Recurvirostra americana*) and black oystercatcher (*Haematopus bachmani*) also breed in the summer in the Northern Study Area (Buchanan 2004).

Table 9.2.

Shorebird species observed within coastal habitats of Washington, Oregon, and Northern California.

Common Name	Latin Name
Black-bellied plover	<i>Pluvialis squatarola</i>
Snowy plover	<i>Charadrius alexandrinus</i>
Black oystercatcher	<i>Haematopus bachmani</i>
Willet	<i>Catoptrophorus semipalmatus</i>
Whimbrel	<i>Numenius phaeopus</i>
Long-billed curlew	<i>Numenius americanus</i>
Marbled godwit	<i>Limosa fedoa</i>
Sanderling	<i>Calidris alba</i>
Western sandpiper	<i>Calidris mauri</i>
Semipalmated plover	<i>Charadrius semipalmatus</i>
Least sandpiper	<i>Calidris minutilla</i>
Dunlin	<i>Calidris alpina</i>
Long-billed dowitcher	<i>Limnodromus scolopaceus</i>
Short-billed dowitcher	<i>Limnodromus griseus</i>
American avocet	<i>Recurvirostra americana</i>
Black-necked stilt	<i>Himantopus mexicanus</i>

(Colwell and Sundeen 2000, Warnock et al. 2002).

9.1.5 Seabirds

Seabird species are both numerous and rich in diversity along the Pacific Coast of North America. The California Current System and the Columbia River boost the nutrient levels in an already nutrient-rich system. The result is an abundance of pelagic bird species that utilize these resources. Within the literature, numerous efforts have been published to characterize pelagic bird communities in the region of interest. Most efforts involve cruising in a controlled manner while an observer or multiple observers note all individual birds that appear near the boat

(Ainley et al. 2005; Batten et al. 2006; Burger and Shaffer 2008). This method provides a species list and an index to relative abundance.

Seabird use of the Northern Study Area is seasonal and driven by physical and biological processes. Ainley et al. (2005) conducted a survey of seabirds in the northern portion of the CCS in 2000 at both the onset and the mature phase of upwelling (June and August) in order to determine which physical and biological oceanographic variables contribute to relative seabird species density. They found 12 species of seabirds contributing 99.2 percent of the total community density and biomass. These were, in order of abundance: the sooty shearwater (*Puffinus griseus*), common murre (*Uria aalge*), Cassin's auklet (*Ptychoramphus aleuticus*), Northern phalarope (*Phalaropus lobatus*), fork-tailed storm petrel (*Oceanodroma furcata*), Leach's storm-petrel (*Oceanodroma leucorhoa*), black footed albatross (*Phoebastria nigripennis*), Northern fulmar (*Fulmarus glacialis*), red phalarope (*Phalaropus fulicarius*), pink-footed shearwater (*Puffinus creatopus*), western gull (*Larus occidentalis*), and the rhinoceros auklet (*Cerorhinca monocerata*). The relative abundance of each species was correlated to the presence or absence of certain physical ocean conditions related to the onset of the upwelling period. As upwelling phased from onset to mature, the overall population estimate of the 12 bird species observed within the study area fell from 745,100 in May to 378,100 by August. The 74 percent drop of the four most abundant birds species in the group—the sooty shearwater, the common murre, the fork-tailed storm-petrel, and Leach's storm-petrel—largely accounts for the difference in abundance.

Seabirds also respond to longer-term physical oceanographic trends. A ten-year compilation of California Cooperative Oceanic Fishing Investigations (CalCOFI) seabird data (1987-1998) showed a trend in warming ocean waters and decreased productivity across many trophic levels. The authors documented changes in the seabird community composition during this period of declining productivity. Changes in seabird densities correlate with environmental conditions including sea surface temperature and El Niño conditions (Veit et al. 1996; Sydeman et al. 2001; Hyrenbach and Veit 2003). Hyrenbach and Veit (2003) found the black storm-petrel, black-vented shearwater, and least storm-petrel were indicators of El Niño conditions; the Cassin's auklet, rhinoceros auklet, and sooty shearwater were indicator species for cold-water affinities; and the Leach's storm-petrel, pink-footed shearwater, and Xantus' murrelet were indicators of warm water.

Resident seabirds typically spend the fall and winter at sea, sometimes foraging far offshore. They return to land to breed and raise their young in the spring and summer, often in large colonies. Sea-bird breeding grounds in the Northern Study Area are spread out along the coast on more than 500 islands and rocks from Washington into Northern California. Many of these sites are protected as wildlife refuges ([see Table 9.1](#)) that provide breeding habitat for a population exceeding two million (USDOJ, USFWS 2009a).

Many seabird species that breed outside of the Northern Study Area in the Southern Hemisphere's spring and summer months (September to March) migrate long distances to forage off the California Current in the northern hemisphere's spring and summer (March to August) (Spear and Ainley 2007). For example, sooty shearwater breed in New Zealand, but were the

most common seabird identified by Ainley et al. (2005) off the coast of Northern California and southern Oregon during the upwelling period from May to August.

At least 29 species of seabirds have been regularly observed during studies conducted off the Pacific Coast and are known to range into the region of interest (Ainley et al. 2005; Batten et al. 2006; Burger and Shaffer 2008). [Table 9.3](#) lists these species and whether they breed or forage in the Northern Study Area. This list does not contain extremely rare species, such as the short-tailed albatross ([see section 9.1.6](#)).

Table 9.3.

Seabird species that forage or breed in the Northern Study Area (NSA)

Common Name	Latin Name	Breed in NSA?
Ashy Storm petrel	<i>Oceanodroma homochroa</i>	CA to Mexico, half the world's population breeds at Farallon NWR
Black-footed albatross	<i>Phoebastria nigripennis</i>	Forage only
Brandt's cormorant	<i>Phalacrocorax penicillatus</i>	From AK to Baja, common breeders offshore rocks of NSA
Caspian tern	<i>Sterna caspia</i>	Pacific, Atlantic, and Gulf coasts, nest on sandy islands
Cassin's auklet	<i>Ptychoramphus aleuticus</i>	Mostly breeds north of NSA in BC, less than a dozen breeding sites in OR
Common murre	<i>Uria aalge</i>	AK to Central CA, rocky islands and cliff ledges
Common tern	<i>Sterna hirundo</i>	Forage only
Double-crested cormorant	<i>Phalacrocorax auritus</i>	From AK to Baja, common breeders offshore rocks of NSA
Fork-tailed storm-petrel	<i>Oceanodroma furcata</i>	From AK to WA, half of West Coast population breeds at Fattery Rocks NWR, north of NSA
Glaucous-winged gull	<i>Larus glaucescens</i>	Breeds along entire coast of WA
Laysan albatross	<i>Phoebastria immutabilis</i>	Forage only
Leach's storm-Petrel	<i>Oceanodroma leucorhoa</i>	From AK to Baja, rocks offshore OR
Long-tailed jaeger	<i>Stercorarius longicaudus</i>	Forage only
Marbled murrelet	<i>Brachyramphus marmoratus</i>	Coastal old-growth forests in NSA
Mottled petrel	<i>Pterodroma inexpectata</i>	Forage only
Murphy's petrel	<i>Pterodroma ultima</i>	Forage only
Northern (red-necked) phalarope	<i>Phalaropus lobatus</i>	Forage only
Parasitic jaeger	<i>Stercorarius parasiticus</i>	Forage only
Pelagic cormorant	<i>Phalacrocorax pelagicus</i>	From AK to Baja, breeds at many sites in the NSA
Pigeon guillemot	<i>Cephus columba</i>	From AK to S CA, prefers protected cliffs
Pink-footed shearwater	<i>Puffinus creatopus</i>	Forage only
Red phalarope	<i>Phalaropus fulicarius</i>	Forage only
Red-breasted merganser	<i>Mergus serrator</i>	Forage only
Rhinoceros auklet	<i>Cerorhinca monocerata</i>	From AK to S CA, offshore islands

Short-tailed shearwater	<i>Puffinus tenuirostris</i>	Forage only
Sooty shearwater	<i>Puffinus griseus</i>	Forage only
Thick-billed murre	<i>Uria lomvia</i>	Forage only
Tufted puffin	<i>Fratercula cirrhata</i>	From AK to S CA, coastal rocks and soil-topped islands
Western gull	<i>Larus occidentalis</i>	From BC to Baja, breeds along entire OR coast islands and offshore rocks

9.1.6 Threatened and Endangered Species

There are five bird species listed as threatened or endangered (T&E) under the Endangered Species Act (ESA) within the Northern Study Area (Table 9.4): The black-footed albatross, the marbled murrelet, the short-tailed albatross (*Phoebastria albatrus*), the western snowy plover, and the California brown pelican (*Pelecanus occidentalis californicus*). Birds are highly mobile, and many pelagic and shorebird species migrate internationally. Species that breed in other countries or on other continents and frequent the open oceans during nonbreeding seasons are often unaccounted for within the ESA. To supplement the T&E list, the International Union for the Conservation of Nature publishes a Red List that classifies species into nine conservation categories (IUCN 2008). Seven pelagic bird species known to occur within the study area are currently classified higher than “Least Concern,” which is defined as widespread and abundant. These are: the black-footed albatross (also under Federal review for listing), the short-tailed albatross (also federally listed), the sooty shearwater, the pink-footed shearwater, the marbled murrelet (also federally listed), the layson albatross, and the mottled petrel. This section describes the status of both federally listed and IUCN listed bird species.

Table 9.4.

Federally Threatened and Endangered Bird Species in the Northern Study Area.

Common Name	Latin Name	ESA Status
Black-footed albatross	<i>Phoebastria nigripes</i>	Under Review
California brown pelican	<i>Pelecanus occidentalis californicus</i>	Endangered
Marbled murrelet	<i>Brachyramphus marmoratus</i>	Threatened
Short-tailed albatross	<i>Phoebastria albatrus</i>	Endangered
Western snowy plover	<i>Charadrius alexandrinus nivosus</i>	Threatened

The Black-footed albatross is expected to decline by 60 percent over the next three generations (56 years), partly because of long-line fishing bycatch (Hyrenbach et al. 2006). This species migrates more than 4,500 km between breeding grounds in Hawaii and foraging grounds off North America. Hyrenbach et al. (2006) documented the importance of three U.S. National Marine Sanctuaries—Cordell Bank, Gulf of the Farallones, and Monterey Bay—as well as the rest of the California Current System off central California for black-footed albatross forage habitat. Hyrenbach et al. (2006) found that the black-footed albatross tends to concentrate along the shelf break and adjacent continental slope offshore of central California and southern Oregon from March to June.

The California brown pelican is listed under the ESA as “endangered.” The California brown pelican breeds outside of the study area in Southern California and south into Mexico and forages within the Northern Study Area up to the coast of Washington. California brown pelican populations plummeted from 1940 to 1970 because of exposure to DDT and persistent marine pollutants. Listed to the ESA in 1970, the species has made a slow recovery and is now under consideration for delisting (USDOJ, USFWS 2009b).

The marbled murrelet can be found year round in the Northern Study Area and is federally listed as “threatened.” The State of California lists the species as “endangered,” and both the State of Washington and Oregon list it as “threatened.” Marbled murrelets breed in coastal old-growth forests where logging has caused loss of breeding habitat. Along with breeding habitat loss, marbled murrelets also face threats in the marine environment while feeding in the open ocean and nearshore. Gillnet fishing, oil spills, marine pollution, predation, and disease are all factors in marbled murrelet declines (USDOJ, USFWS 2009c), as is food availability (Peery et al. 2004).

The short-tailed albatross is rare in the Northern Study Area and is listed as “endangered” under the Endangered Species Act. Nearly driven to extinction by hunting in the early 20th century, the species is making a slow recovery. The short-tailed albatross breeds in Japan and forages throughout the Pacific, occasionally in the Northern Study Area. Bycatch in the Alaskan long-line fishing fleet is a concern, though management actions to discourage albatross from diving on baited lines has been effective (Melvin et al. 2006).

The Western snowy plover is listed under the ESA as a “threatened species.” The Western snowy plover breeds on the sandy beaches of all three states in the Northern Study Area. There are only 1,800 breeding pairs of snowy plovers between Damon Point, Washington and Baja, California (Point Reyes National Seashore 2009). Breeding season is from March to September.

Sooty shearwater numbers in the California Current System have declined 90 percent in the last 20 years (Veit et al. 2006; IUCN 2009). Sooty shearwaters are discussed above in reference to their relative abundance off Northern California and southern Oregon in the spring, corresponding to the onset of the upwelling period (Ainley 2005). Like the black-footed albatross, the sooty shearwater breeds far from the Northern Study Area in New Zealand, Australia, Chile, and the Falkland Islands. Worldwide, the species is listed by the IUCN as “near threatened” (IUCN 2009).

The pink-footed shearwater is listed by the IUCN as “vulnerable” because of its small breeding range confined to only three locations—Robinson Crusoe Island off the coast of Chile, Santa Clara Island in the Juan Fernandez Islands, and Isla Mocha off the coast of Arauco, Chile (IUCN 2009). Shearwaters forage off the coast of North America from April to November.

The Laysan albatross is listed as “vulnerable” by the IUCN in response to declining populations in the late 1990s and early 2000s. More recent data indicate that the breeding population has rebounded (IUCN 2009). The Laysan albatross breeds outside of the Northern Study Area in the northwestern Hawaiian Islands and forages off the West Coast of North America in spring and

summer. The Laysan albatross is threatened by long-line and high seas drift-net fisheries. As open-ocean foragers, albatross mistakenly ingest floating plastic and other marine debris, which can cause mortality in both adults and chicks.

The mottled petrel breeds in New Zealand and is listed by the IUCN as “threatened.” This species is uncommon in the Northern Study Area, concentrating north in the Bering Sea and Alaska in spring and summer. It is listed as “near threatened” due to its small breeding range. The Murphy’s petrel is also listed as “near threatened” by the IUCN. Like the other seabirds described in this section, it breeds far from the Northern Study Area, returning to feed offshore in the California Current System. Little is known of this species and it is believed to be declining due to egg predation by rats.

9.2 BREEDING AND REPRODUCTIVE ECOLOGY

The breeding and reproductive ecology of birds found in the Northern Study Area is extremely variable due to the large numbers of shorebird, seabird, marshbird, and waterbird species. Most seabirds form large nesting colonies on inaccessible habitats, such as cliffs and islands, to avoid mammalian predators. The value of these colonies has been recognized with the creation of NWRs ([see section 9.1.1](#) and [12.3](#)). Breeding generally occurs during spring for those species that breed within the Northern Study Area ([see table 9.3](#) for seabird species that breed in the Northern Study Area).

Most shorebirds that occur along the coasts of Washington, Oregon, and California do not breed within the Northern Study Area and only occur there during migration and winter (Brown et al. 2001; Colwell and Sundeen 2000; Warnock et al. 2002). However, the Western snowy plover, a federally threatened species, has regularly nested at five sites in Washington. This species prefers to breed on open sandy beaches and is found in small numbers in Grays Harbor and Pacific Counties of Washington (WDFW 2009).

9.3 FORAGING ECOLOGY AND FOOD HABITS

Foraging grounds for marshbirds, waterbirds, and shorebirds include uplands, estuaries, and embayments as well as coastal intertidal zones. These areas are sensitive to human disturbance and natural perturbations by storms and weather events. Birds feeding in shallow waters consume a variety of organisms consisting mainly of invertebrates. Diets can include terrestrial and aquatic organisms that do not reside in these areas, but their eggs and larvae serve as bird forage. Marshbirds commonly consume epifaunal or pelagic organisms including aquatic insects and larvae, and small fishes (Baird 1993). Shorebirds mainly feed on invertebrates present in shallow waters and associated wetlands, beaches, mudflats, and other tidelands. Many migratory stopover areas are present along the Pacific Coast and protections are in place for the major sites such as Grays Harbor, Washington and Humboldt Bay, California. Shorebirds consume a wide spectrum of organisms; the bird’s foraging technique dictates if a species consumes mainly epifaunal or infaunal organisms (Hui and Beyer 1998). Many shorebirds can be seen digging or probing for prey in the sediment on sandy beaches while other species forage for mollusks on rocky shores. The abundance of shorebirds on sandy beaches is significantly correlated with

prey biomass (Dugan 2006); these birds will seek other foraging areas when beaches become too crowded (Baird 1993).

Seabirds feed mainly on fish and invertebrates. Some species are ubiquitous and are not faithful to specific foraging areas, while others may rely on specific habitat features during foraging (Vlietstra 2005; Yen et al. 2006). Plunge feeders, such as gulls and terns, are reliant upon forage that either naturally occurs near the surface or is displaced there, while diving species may access forage not available at the surface (Henkel 2006). As discussed in [section 9.1.5](#), oceanographic and climate conditions, such as upwelling and ENSO, strongly influence productivity, prey availability, and seabird feeding strategies in the Northern Study Area.

9.4 ESTIMATED FOOD CONSUMPTION

It is difficult to estimate total bird food consumption in the Northern Study Area. Roth et al. (2008) used a model based on metabolic rates to estimate the annual prey consumption for common murre in the California Coastal Current from Cape Blanco, Oregon to Point Conception, California. The model estimates that common murre consumed 222,235 metric tons of fish and squid per year in the mid 2000s. Murre consumption exceeded commercial fishery landings for some species such as squid and hake. This example demonstrates that seabirds consume a substantial percentage of available prey species in the Northern Study Area.

9.5 MIGRATORY FLYWAYS

Migratory flyways are not clearly known for many seabirds. Shorebird migration routes have been broadly recognized, with the Pacific Coast being one of the major routes (Warnock and Bishop 1998; Brown et al. 2001). [Figure 9.1](#) shows a map of the Pacific Flyway (USFWS 2010).

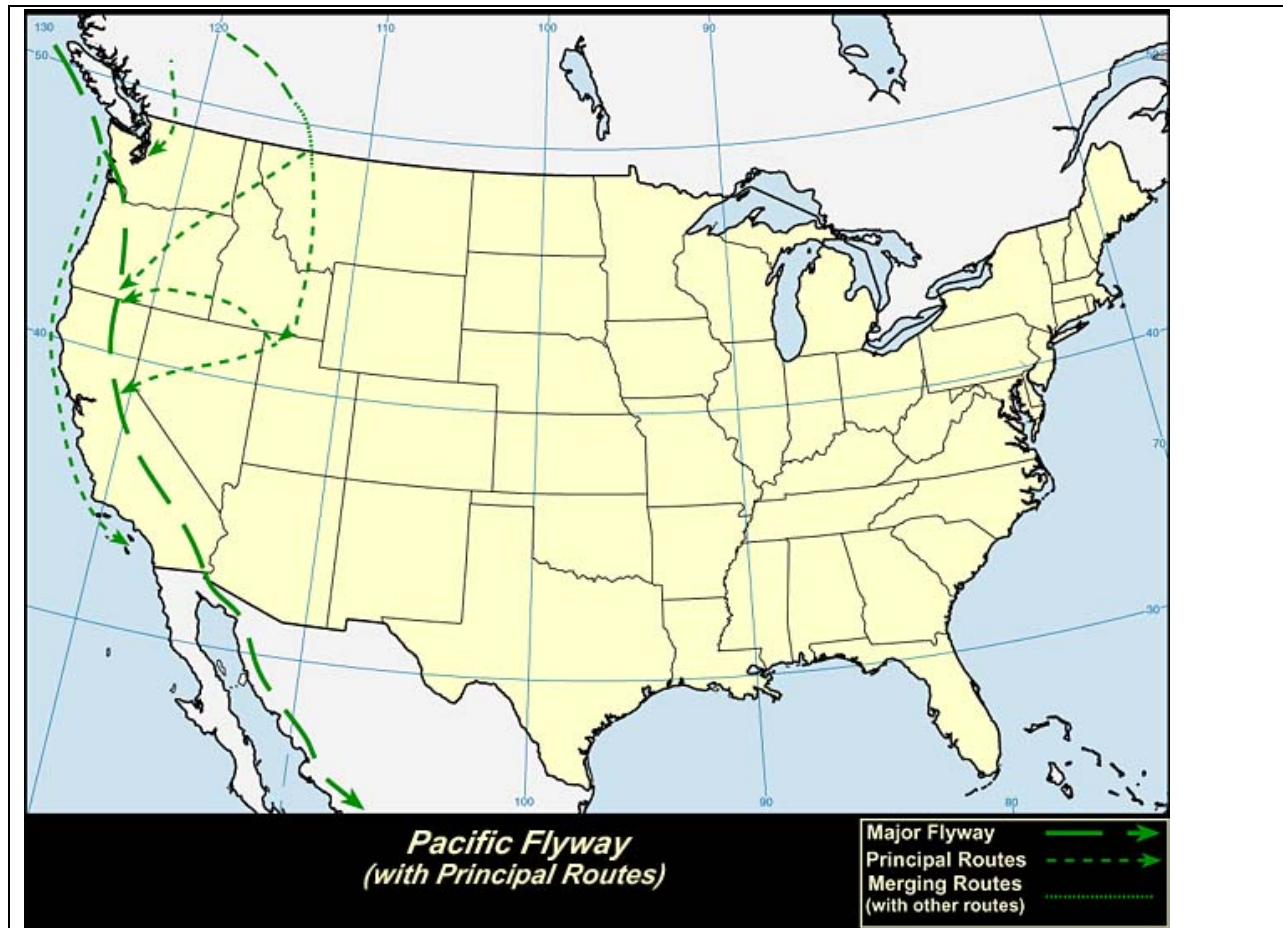

Figure 9.1. Map of the Pacific Flyway (U.S. Fish & Wildlife Service)

9.6 SUMMARY AND DATA GAPS

Although specific links have been made between seabird and waterfowl distribution, abundance, and forage availability, information on the seasonal distribution and abundance along the Pacific Coast of the United States is sparse or does not exist at the scale needed to assess adequately the potential impact of renewable energy development on birds. The scale at which these studies are needed to analyze impacts depends on the migratory range or feeding area of the population; in some cases habitat use by seabirds and waterfowl is needed in each coastal water body, for other species, coarser habitat links are sufficient. Seasonal seabird and waterfowl density maps are needed to define important feeding, breeding and other high use areas, migration routes, and flight pathways of large breeding colonies (Fox et al. 2006). Additionally, avoidance behavior of key species should be evaluated (Fox et al. 2006). Further data gaps exist in detailed information about migration corridors, including distance from shore, timing of migration, and height of passage, each correlated with weather and climate conditions, which would be helpful in siting renewable energy infrastructure.

Accurate rates of consumption of marine organisms need to be established to determine the energetic consequences of avoiding foraging areas because of offshore structures. Similarly, it is important to collect data in order to model the energetic needs of birds in the Northern Study Area, to understand their reproductive fitness and the stress that new offshore development may cause. Offshore seabird distribution has been related to forage abundance (Vlietstra 2005), yet there is little information to identify the forage utilized by Pacific seabird species or the distribution and abundance of forage, as related to the Northern Study Area.

9.7 LIST OF LITERATURE CITED—BIRD RESOURCES

- Ainley, D.G., L.B. Spear, C.T. Tynan, J.A. Barth, S.D. Pierce, R.G. Ford and T.J. Cowles. 2005. Physical and biological variables affecting seabird distributions during the upwelling season of the Northern California current. *Deep Sea Research Part II: Topical Studies in Oceanography* 52(1-2):123-143.
- Baird, P.H. 1993. Birds. In: M. Dailey, D. Reish, and J. Anderson. *Ecology of the Southern California Bight: A synthesis and interpretation*. University of California Press. 541-603.
- Batten, S.D., K.D. Hyrenbach, W.J. Sydeman, K.H. Morgan, M.F. Henry, P.P.Y. Yen and D.W. Welch. 2006. Characterising meso-marine ecosystems of the North Pacific. *Deep-Sea Research Part II-Topical Studies in Oceanography* 53(3-4):270-290.
- Brown, S., C. Hickey, B. Harrington and R. Gill (eds.). 2001. *The U.S. shorebird conservation plan, 2nd edition*. Manomet Center for Conservation of Species. Manomet, MA.
- Buchanan, J.B. 2004. *Shorebirds: Plovers, Oystercatchers, Avocets and Stilts, Sandpipers, Snipes, and Phalaropes. Management Recommendations for Washington's Priority Species, Volume 4*. E. Larsen, J.M. Azerrad, and N. Nordstrom. Olympia, WA. Washington Dept. of Fish and Wildlife.
- Burger, A.E. and S.A. Shaffer. 2008. Application of tracking and data-logging technology in research and conservation of seabirds. *The Auk* 125(2):253-264.
- Burger, J. 1991. Coastal landscapes, coastal colonies, and seabirds. *Reviews in Aquatic Sciences* 4(1):23-43.
- Colwell, M.A. and K.D. Sundeen. 2000. Shorebird distributions on ocean beaches of Northern California. *Journal of Field Ornithology* 71(1):1-15.
- Dugan, J. 2006. Utilization of sandy beaches by shorebirds: relationships to population characteristics of macrofauna prey species and beach morphodynamics. U.S. Dept. of Interior, Minerals Management Service, University of California, and Coastal Marine Institute. MMS OCS Study 06-0069. 34.
- Fleskes, J.P. and J.L. Yee. 2007. Waterfowl distribution and abundance during spring migration in southern Oregon and northeastern California. *Western North American Naturalist* 67(3):409-428.

- Fox, A.D., M. Desholm, J. Kahlert, T.K. Christensen, and I.K. Petersen. 2006. Information needs to support environmental impact assessment of the effects of European marine offshore wind farms on birds. *Ibis* 148:129-144.
- Hashmi, D. and D. Causey. 2008. A system in which available energy per se controls alpha diversity: Marine pelagic birds. *American Naturalist* 171(4):419-429.
- Henkel, L.A. 2006. Effect of water clarity on the distribution of marine birds in nearshore waters of Monterey Bay, California. *Journal of Field Ornithology* 77(2):151-156.
- Hui, C.A. and W.N. Beyer. 1998. Sediment ingestion of two sympatric shorebird species. *Science of the Total Environment*, 224 (1-3): 227-233.
- Hyrenbach, K.D., C. Keiper, S.G. Allen, D.G. Ainley and D.J. Anderson. 2006. Use of marine sanctuaries by far-ranging predators: Commuting flights to the California Current System by breeding Hawaiian albatrosses. *Fisheries Oceanography* 15(2):95-103.
- Hyrenbach, K.D. and R.R. Veit. 2003. Ocean warming and seabird communities of the Southern California Current System (1987-98): response at multiple temporal scales. *Deep-Sea Research Part II-Topical Studies in Oceanography* 50(14-16):2537-2565.
- International Union for the Conservation of Nature (IUCN). 2009. IUCN Red List of Threatened Species. Version 2009.1. Internet website: www.iucnredlist.org. Accessed May 27 2009.
- International Union for the Conservation of Nature (IUCN). 2008. Guidelines for using the International Union for the Conservation of Nature, Standards and Petitions Working Group. Red List categories and criteria. Version 7.0.
- Jensen, M. 2009. Personal communication. Wildlife Biologist, FWS, Western Washington Fish and Wildlife Office, Lacey, WA 98503. March 4, 2005.
- Lee, D.E., N. Nur and W.J. Sydeman. 2007. Climate and demography of the planktivorous Cassin's auklet *Ptychoramphus aleuticus* off Northern California: Implications for population change. *Journal of Animal Ecology* 76(2):337-347.
- Lewis, J.C. and D. Kraege. 2004. Harlequin duck: *Histrionicus histrionicus*. Management Recommendations for Washington's Priority Species, Volume 4. E. Larsen, J.M. Azerrad and N. Nordstrom. Olympia, WA, Washington Dept. of Fish and Wildlife.
- Melvin, E.F., K.S. Dietrich and M.D. Wainstein. 2006. Solving seabird bycatch in Alaskan fisheries: A case study in collaborative research. Washington Sea Grant Program.
- Nadav, N., S. Zack, J. Evens and T. Gardali. 1997. Tidal marsh birds of the San Francisco Bay region: Status, distribution, and conservation of five Category 2 taxa. Stinson Beach, California.

- Oceanographic Institute of Washington and Human Resources Planning Institute. 1977. A summary of knowledge of the Oregon and Washington coastal zone and offshore areas. Springfield, VA: U.S. Dept. of Commerce, National Technical Information Service.
- Parrish, J.K., N. Bond, H. Nevins, N. Mantua, R. Loeffel, W.T. Peterson and J.T. Harvey. 2007. Beached birds and physical forcing in the California Current System. *Marine Ecology-Progress Series* 352:275-288.
- Peery, M.Z., S.R. Beissinger, S.H. Newman, E.B. Burkett and T.D. Williams. 2004. Applying the declining population paradigm: Diagnosing causes of poor reproduction in the marbled Murrelet. *Conservation Biology* 18(4):1088-1098.
- Point Reyes National Seashore. 2009. Internet website: <http://www.nps.gov/pore/>. Accessed May 27, 2009.
- Quinn, T. and R. Milner. 2004. Great Blue Heron: *Ardea herodias*. Management Recommendations for Washington's Priority Species, Volume 4. E. Larsen, J.M. Azerrad, and N. Nordstrom. Olympia, WA, Washington Dept. of Fish and Wildlife.
- Roth, J.E., N. Nur, P. Warzybok and W.J. Sydeman. 2008. Annual prey consumption of a dominant seabird, the common Murre, in the California Current System. *ICES J. Mar. Sci.* 65(6):1046-1056.
- Spear, L.B. and D.G. Ainley. 2007. Storm-petrels of the eastern Pacific Ocean: Species assembly and diversity along marine habitat gradients. *Ornithological Monographs* 2007(62):1-77.
- Sydeman, W.J., M.M. Hester, J.A. Thayer, F. Gress, P. Martin and J. Buffa. 2001. Climate change, reproductive performance and diet composition of marine birds in the Southern California Current System, 1969. 1997. *Progress in Oceanography* 49:309-329.
- Takekawa, J.Y., N. Warnock, G.M. Martinelli, A.K. Miles and D.C. Tsao. 2002. Waterbird use of Bayland wetlands in the San Francisco Bay estuary: Movements of Long-billed Dowitchers during the Winter. *Waterbirds* 25 (special publication 2):93-105.
- Thayer, J.A. and W.J. Sydeman. 2007. Spatio-temporal variability in prey harvest and reproductive ecology of a piscivorous seabird, *Cerorhinca monocerata*, in an upwelling system. *Marine Ecology-Progress Series* 329:253-265.
- U.S. Dept. of Interior, Fish and Wildlife Service (USFWS). 2009a. Farallon Islands National Wildlife Refuge. Internet website: <http://www.fws.gov/SFBAYREFUGES/Farallon/>. Accessed May 11, 2009.
- U.S. Dept. of Interior, Fish and Wildlife Service (USFWS). 2009b. Brown pelican species profile. Internet website: <http://ecos.fws.gov/speciesProfile/profile/speciesProfile.action?sPCODE=B02L>. Accessed July 8, 2009.

- U.S. Dept. of Interior, Fish and Wildlife Service (USFWS). 2009c. Marbled Murrelet species profile. Internet website: http://www.fws.gov/arcata/es/birds/MM/m_murrelet.html. Accessed May 27, 2009.
- Veit, R.R., P. Pyle and J. A. McGowan. 1996. Ocean warming and long-term change in pelagic bird abundance within the California Current System. *Marine Ecology-Progress Series* 139(1-3):11-18.
- Vlietstra, L.S. 2005. Spatial associations between seabirds and prey: Effects of large-scale prey abundance on smallscale seabird distribution. *Marine Ecology-Progress Series* 291:275-287.
- Warnock, N. and M.A. Bishop. 1998. Spring stopover ecology of migrant Western Sandpipers. *Condor* 100(3):456-467.
- Warnock, N., G.W. Page, T.D. Ruhlen, N. Nur, J.Y. Takekawa and J.T. Hanson. 2002. Management and conservation of San Francisco Bay salt ponds: Effects of pond salinity, area, tide, and season on Pacific flyway waterbirds. *Waterbirds* 25:79-92.
- Warnock, N., J.Y. Takekawa and M.A. Bishop. 2004. Migration and stopover strategies of individual Dunlin along the Pacific Coast of North America. *Canadian Journal of Zoology-Revue Canadienne De Zoologie* 82(11):1687-1697.
- Willapa National Wildlife Refuge. 2009. Internet website: <http://www.fws.gov/Refuges>. Accessed May 27, 2009.
- Wilson, U.W. 2005. The effect of the 1997-1998 El Niño on rhinoceros auklets on Protection island, Washington. *Condor* 107(2):462-468.
- Yen, P.P.W., W.J. Sydeman, S.J. Bograd and K.D. Hyrenbach. 2006. Spring-time distributions of migratory marine birds in the Southern California current: Oceanic eddy associations and coastal habitat hotspots over 17 years. *Deep-Sea Research Part II-Topical Studies in Oceanography* 53(3-4):399-418.

10. MARINE MAMMALS

10.1 INTRODUCTION

Marine mammals occurring along the U.S. West Coast include cetaceans (including baleen and toothed whales, dolphins, and porpoises), pinnipeds (seals and sea lions), and sea otters. Marine mammal species can be considered Endangered or Threatened under the Endangered Species Act of 1973 (ESA). In the Northern Study Area, there are seven species of baleen whales (suborder Mysticeti); all but gray whales and minke are federally listed as threatened or endangered. Seventeen species of toothed whales and dolphins (suborder Odontoceti) inhabit the Northern Study Area, two of which are listed as Endangered Species (sperm whales and Southern Resident killer whales). This region also includes six pinnipeds and also sea otters, two of which are listed as Threatened Species (Steller sea lions, and Guadalupe fur seal) ([Table 10.1](#)). The Marine Mammal Protection Act also calls for identifying specific stocks or populations that are below optimum sustainable population levels and designate these as depleted. Furthermore a designation of strategic is applied to any stock that is depleted under the MMPA, is listed or likely to be listed as threatened or endangered under the ESA, or has a level of direct human mortality that exceeds a calculated sustainable potential biological removal rate. These are discussed below on a species by species basis.

Table 10.1.

Marine Mammal Species Occurrence and Habitats for Northern Planning Area, Grays Harbor to San Francisco Bay.

Species	Habitat*	Relative abundance**	Federal status***
Blue whale	CS, SL, OF	C	EN
Fin whale	OF	C	EN
Humpback whale	CS, SL	C	EN
Sei whale	OF	R	EN
Minke whale	CS, SL, OF	C	NL
N. Pacific right whale	CS?	R	EN
Gray whale	CS	C	NL
Sperm whale	OF	C	EN
Pygmy sperm whale	OF	R	NL
Dwarf sperm whale	OF	R	NL
Baird's beaked whale	OF	UC	NL
Cuvier's beaked whale	SL, OF	UC	NL
Hubb's beaked whale	OF	UC	NL
Stejneger's beaked whale	OF	UC	NL
Killer whales			
- southern residents	CS, SL	C	EN
- northern residents	CS, SL	UC	NL
- offshore	CS, SL, OF	C	NL

- transients	CS, SL	C	NL
Pacific white-sided dolphin	CS, SL, OF	C	NL
Northern right-whale dolphin	CS, SL, OF	C	NL
Risso's dolphin	CS, SL, OF	C	NL
Short-beaked common dolphin	SL, OF	C	NL
Bottlenose dolphin	SL, OF	UC	NL
Striped dolphin	OF	UC	NL
Short-finned pilot whale	SL, OF	R	NL
False killer whale	CS, SL, OF	AC	NL
Harbor porpoise	CS	C	NL
Dall's porpoise	CS, SL, OF	C	NL
Harbor seal	T, CS	C	NL
Northern elephant seal	T, OF	UC	NL
California sea lion	T, CS	C	NL
Steller sea lion	T, CS	C	TH
Northern fur seal	OF	UC	NL
Guadalupe fur seal	OF	AC	TH
Northern Sea otter	CS	UC	NL

*T = Terrestrial haul-out, CS = continental shelf, SL = continental slope, OF = offshore

**AC = accidental, R = rare, UC = uncommon, C = common.

***EN = endangered, TH = threatened, NL = not listed

10.2 SPECIES ACCOUNTS

10.2.1 Blue Whale (*Balaenoptera musculus*)

10.2.1.1 Distribution and Migration

Blue whales were widely distributed in the North Pacific prior to modern commercial whaling in the early 1900s. Currently, there appear to be at least two distinct populations of blue whales in the North Pacific based on differences in the underwater vocalizations between blue whales in the eastern North Pacific and those in the central and western North Pacific (Rivers 1997; Stafford et al. 1999; Stafford et al. 2001). Blue whales occupy the waters both on the Continental Shelf as well as offshore in the eastern North Pacific and range from tropical waters off Central America north to Alaskan waters. They make annual migrations between feeding areas in summer and fall and warmer tropical waters in winter and spring. Recent research has shown that unlike many other baleen whales, blue whales feed even in these low-latitude areas in winter (Cascadia Research, unpublished data). Blue whales that feed off the U.S. West Coast have been documented migrating to the waters off Baja, California, the Gulf of California and the Costa Rica Dome in the eastern tropical Pacific (Calambokidis et al. 1990; Mate et al. 1999).

Large concentrations of blue whales have been documented off, Baja, California, and the eastern tropical Pacific since the 1970s (Wade and Friedrichsen 1979; Calambokidis et al. 1990; Reilly and Thayer 1990; Barlow 1994; Calambokidis and Barlow 2004; Barlow and Forney 2007). Recent sightings and photo-identification of whales off British Columbia and Alaska suggest that

whales in these northern waters are part of the same population as those in the south and that a shift in distribution has occurred that may be a return to a migration pattern that occurred historically (Calambokidis et al. 2009a).

Currently, blue whales occur throughout the Northern Planning Area, with higher concentrations in Northern California (Calambokidis et al. 1990; Barlow and Forney 2007). Large numbers of whales are documented off California; fewer have been detected off Washington, Oregon, British Columbia and Alaska (Chandler and Calambokidis 2003b; Calambokidis and Barlow 2004; Barlow and Forney 2007; Calambokidis et al. 2009a).

10.2.1.2 Abundance

The abundance of blue whales in the eastern North Pacific has been estimated to be 2,000 to 3,000 based on results of line-transect surveys and capture-recapture from photographically identified individuals (Calambokidis and Barlow 2004). The U.S. stock assessments use a best estimate of blue whales along the U.S. West Coast to be 1,368 (CV = 0.22) based on a weighted average of both line-transect and mark-recapture estimates (Carretta et al. 2008). From vessel transects between 1991 and 2005, Barlow and Forney (2007) estimated abundance off California-Oregon-Washington at 1,548 (CV = 0.16). For waters in the Northern Planning Area, regional estimates from these surveys were 155 (CV = 0.37) blue whales off Northern California (north of Point Reyes) and 63 (CV = 0.51) whales off Oregon and Washington (Barlow and Forney 2007). This is consistent with the finding that the largest portion of the blue whale population occurred off southern and central California south of the Northern Planning Area.

Although the eastern North Pacific population of blue whales would be expected to have increased since the cessation of whaling in 1966, there is no evidence to show that the population has grown (Carretta et al. 2008). Possible large-scale changes in blue whale distribution observed recently within the eastern North Pacific (Calambokidis et al. 2009a) confound efforts to adequately assess trends in abundance.

10.2.1.3 Foraging and Ecological Context

Blue whales feed exclusively on euphausiids (krill). The California coast is one of the most important feeding areas for the eastern North Pacific stock in the summer and fall (Carretta et al. 2008). Blue whales migrate in winter to productive waters, where feeding has also been documented (Calambokidis and Mate, unpubl. data). Killer whales are the only known predator of blue whales; rake mark tooth scars on the bodies of blue whales are caused by killer whale attacks (Mehta et al. 2007).

10.2.1.4 Status/Threats

Blue whales are listed as endangered under the Endangered Species Act (ESA). The eastern North Pacific stock is considered a “strategic” stock under the Marine Mammal Protection Act (MMPA) (Carretta et al. 2008). Ship strikes are a current concern, as numerous blue whales have been killed in recent years (Carretta et al. 2008), particularly off California, where at least four blue whales were struck and killed by ships in the fall of 2007, apparently while feeding in the shipping channels in and around the Santa Barbara Channel (Carretta et al. 2008; Cascadia Research, unpubl. data). Off Washington State, ship strikes have become a growing concern;

blunt force trauma resembling a ship strike was determined to be the cause of death of two blue whales off Washington between 1980 and 1989 and four fin whales were apparent victims of ship strikes in 2002 (Douglas et al. 2008). Increasing levels of anthropogenic sound are also thought to be a threat to blue whales worldwide (Reeves 1992; Croll et al. 2001).

10.2.2 Fin Whale (*Balaenoptera physalus*)

10.2.2.1 Distribution and Migration

Fin whales range widely in both coastal and offshore waters of the North Pacific. Little is known about their population structure and migrations and there is some evidence of year-round occurrence in some areas, including California waters (Forney et al. 1995; Barlow 1997). In the Northern Planning Area, fin whales have been observed in all areas (Green et al. 1992; McDonald 1994; Forney et al. 1995; Douglas et al. 2008) and acoustic signals have been documented in this region year-round (Moore et al. 1998).

10.2.2.2 Abundance

Barlow and Forney (2007) estimate abundance along the U.S. West Coast to be 2,636 (CV = 0.15) based on line-transect surveys conducted between 2001 and 2005. For waters off Northern California (north of Point Reyes), their estimate was 448 (CV = 0.43), and for waters off Oregon-Washington it was 299 (CV = 0.33). These were considered underestimates because some fin whales were probably treated as unidentified at a distance.

10.2.2.3 Foraging and Ecological Context

In the northern hemisphere, fin whales primarily feed on euphausiids, although their diet probably varies by prey availability. They are known to feed on other copopods and small schooling fish (Aguilar 2002; Hewitt and Lipsky 2002). Killer whales are their only known predator (Aguilar 2002).

10.2.2.4 Status/Threats

Fin whales are listed as endangered under the Endangered Species Act. The eastern North Pacific stock is considered a strategic stock under the MMPA (Carretta et al. 2008). As with blue whales, ship strikes are a current concern affecting mortality in recent years (Carretta et al. 2008). Five fin whales were found dead in or near Washington waters in recent years, all as an apparent result of ship strikes (Douglas et al. 2008). Such events were rare in this area previously, but in 2002 alone, four fin whale carcasses were recovered in Washington and Oregon, their deaths all related to ship strikes. Three of these animals were brought into Cherry Point, Port of Seattle, and Portland wrapped around the bows of ships coming into port; the fourth animal, found floating in the waters around the San Juan Islands, had apparently died of a collision with a ship as well. Another fin whale, found dead near Lummi Island in 2006, also was determined to be the victim of a ship strike. While it is not known where these animals were struck, the occurrence of so many incidents in a short period suggested that a concentration of fin whales inhabited waters off Washington near the shipping lanes. Increasing levels of anthropogenic sound are also thought to be a threat to all baleen whales, which communicate using low-frequency sound (Reeves 1992; Croll et al. 2001).

10.2.3 Sei whale (*Balaenoptera borealis*)

10.2.3.1 Distribution and Migration

Less is known about sei whales than about some of the other balaenopterid whales. In the North Pacific, the International Whaling Commission (IWC) considers them a single stock, although it is possible that those seen offshore are separate from those found in more coastal areas (Carretta et al. 2008). Whaling takes showed a continuous distribution of animals within the North Pacific basin between latitudes 45 and 55° N (Masaki 1977; Carretta et al. 2008). While sei whales were once the fourth most commonly killed species by coastal whalers off California (Rice 1974; Clapham et al. 1997), they are now rare in this region (Dohl 1983; Barlow and Forney 2007; Carretta et al. 2008). There were no sei whale strandings off the coasts of Oregon or Washington between 1930 and 2002 (Norman et al. 2004). This absence is a mystery to researchers (Barlow and Forney 2007).

10.2.3.2 Abundance

Few sei whales inhabit the waters of the U.S. West Coast. Barlow and Forney (2007) estimate abundance to be under 100 animals (98 whales, CV = 0.57) based on line-transect surveys conducted between 2001 and 2005. In the Northern Planning Area, the estimate off Northern California (north of Point Reyes) was 47 (CV = 0.68); 37 (CV = 1.14) sei whales were estimated off Oregon and Washington (Barlow and Forney 2007).

10.2.3.3 Foraging and Ecological Context

Horwood (2002) differentiates sei whales from the other large rorquals by their feeding behavior: Sei whales tend to feed by skimming along the surface on patches of copepods. This behavior resembles that of right whales. Sei whales are probably more opportunistic feeders than blue and fin whales, because they also feed on small fish and squid (Hewitt and Lipsky 2002; Horwood 2002). Their only known predator is killer whales (Jefferson et al. 1991).

10.2.3.4 Status/Threats

Sei whales are listed as endangered under the Endangered Species Act. The eastern North Pacific stock is considered a strategic stock under the MMPA (Carretta et al. 2008). Fishery interactions and ship collisions are two concerns for mortality of this species. One sei whale recovered in Washington was killed by a ship strike in 2003 (Douglas et al. 2008). Increasing levels of anthropogenic sound are also thought to be a threat to all baleen whales, which communicate using low-frequency sound (Reeves 1992; Croll et al. 2001).

10.2.4 Minke Whale (*Balaenoptera acutorostrata*)

10.2.4.1 Distribution and Migration

Minke whales are the smallest and most abundant of all the baleen whales worldwide. Their size and behavior make them difficult to detect; their blows are indistinct and their surfacing profiles are low. Relatively little is known about the population structure and movements of minke whales in the eastern North Pacific. They are thought to be abundant in the Bering and Chukchi Seas and the Gulf of Alaska and less abundant in other parts of the eastern North Pacific

(Leatherwood et al. 1982; Brueggeman et al. 1990; Green et al. 1992). In the North Pacific, they generally inhabit the waters over continental shelves (Brueggeman et al. 1990).

While these whales are believed to be migratory, their behavior in inland Washington and California suggests that some of them establish at least summer home ranges (Dorsey et al. 1990). Because these “resident” whales appear to be behaviorally distinct from the migratory animals off Alaska, minke whales off California, Oregon, and Washington are considered as a separate stock (Carretta et al. 2008).

In the Northern Planning Area, minke whales tend to feed in inland, coastal, and offshore waters. They have been intensely studied in the inland waters of Washington State, especially around the San Juan Islands, where they exhibit exclusive home ranges, which they return to annually (Dorsey 1983; Hoelzel et al. 1989; Dorsey et al. 1990). In Washington inland waters, minke whales are seen in northern Puget Sound, the San Juan Islands, and the Gulf Islands (Osborne et al. 1988). Four sightings of minke whales were made off northern Washington ranging from less than 10 to more than 50 nmi offshore during surveys conducted by the Olympic Coast National Marine Sanctuary from 1995 to 2002 (Calambokidis et al. 2004). Only one minke whale was seen off the coast of Washington during monthly aerial surveys in 1989 and 1990; it was observed in the slope waters off the Astoria Canyon (Green et al. 1992). A total of 21 minke whales were stranded on the Washington and Oregon beaches between 1930 and 2002 (Norman et al. 2004).

10.2.4.2 Abundance

Abundance estimates for minke whales are problematical because minke whales are difficult to detect. Barlow and Forney (2007) estimated 823 (CV = 0.56) minke whales for the waters off California, Oregon, and Washington using ship transect survey data collected between 1991 and 2005. Minke whales were not well sampled during these broad scale cruises, and densities may have been underestimated because detection probabilities were not estimated directly (Barlow and Forney 2007). Regional abundances were estimated at 102 (CV = 1.56) for Northern California (north of Point Reyes to the border) and 211 (CV = 0.84) for the Oregon and Washington coasts (Barlow and Forney 2007). There are no data on trends in abundance for this region.

10.2.4.3 Foraging and Ecological Context

Minke whales in the Antarctic feed mostly on euphausiids, while in other areas they are thought to consume small fish, copepods, and squid (Hewitt and Lipsky 2002). In the San Juan Islands, whales feed on schools of herring and sand lance (Osborne et al. 1988). Killer whales are predators of minke whales. Attacks have been witnessed in the Strait of Juan de Fuca, off British Columbia and southeastern Alaska (Ford et al. 2005a). Minke whales are occasionally caught in coastal and offshore gillnets (Carretta et al. 2008).

10.2.4.4 Status/Threats

Minke whales are not listed under the Endangered Species Act and are not considered “depleted” or strategic under the MMPA.

10.2.5 Humpback Whale (*Megaptera novaengliae*)

10.2.5.1 Distribution and migration

Humpback whales range widely in the North Pacific; they migrate seasonally between feeding areas in productive northern waters and warm-water winter breeding and calving areas (Rice 1978). Primary wintering regions in the North Pacific occur off Mexico, Central America, Hawaii, and Asia. Summer feeding areas extend from the coastal waters off Southern California north to the Gulf of Alaska and Bering Sea and west through the Aleutian Islands into the waters off Russia.

Humpback whales show site fidelity to specific feeding areas. There is very limited interchange of individuals among feeding areas and there are significant differences in the mitochondrial DNA patterns in whales using different feeding areas (Baker et al. 1990; Baker et al. 1994; Calambokidis et al. 1996). Two separate feeding aggregations inhabit the Northern Planning Area: one that ranges from Southern California to Oregon (referred to as the “California-Oregon stock”) and another that ranges from northern Washington to southern British Columbia. Movement data show a low rate of interchange among whales inhabiting these regions although there is no clear geographic boundary that divides these two stocks (Calambokidis et al. 2001, 2004b). Feeding areas off northern Washington are unevenly distributed; high whale densities are seen along the Washington/British Columbia boundaries along southern Vancouver Island and near the continental shelf edge (Calambokidis et al. 2004).

The migratory destinations of the humpback whales that feed along the U.S. West Coast are varied. The primary winter grounds for humpback whales off California are mainland Mexico and Central America (Calambokidis et al. 2000; Calambokidis et al. 2008). Off northern Washington, the humpback whales are a more diverse mix of animals from all known wintering areas (Central America, Mexico, Hawaii, and Asia, Darling et al. 1996; Calambokidis et al. 2000; Calambokidis et al. 2004; Falcone et al. 2005; Calambokidis et al. 2008).

10.2.5.2 Abundance

Abundance estimates of humpback whales off the U.S. West Coast have been made both from line-transect surveys and from capture-recapture of individually identified whales (Calambokidis and Barlow 2004; Calambokidis et al. 2004; Barlow and Forney 2007; Forney 2007). The most comprehensive transect survey in 2005 estimated abundance to be 1,769 (CV = 0.16) humpback whales for the entire U.S. West Coast region. Regional transect estimates are 231 (CV = 0.36) for Oregon and Washington and 90 (CV = 0.47) for Northern California (north of Point Reyes)(Barlow and Forney 2007).

Due to their highly clumped distributions, mark-recapture methods have provided precise estimates of abundance using photo-identification across years (Calambokidis and Barlow 2004). The most recent estimate for the California-Oregon feeding aggregation is 1,648 (CV = 0.11); humpback whale abundance has increased in this region 7.5 percent per year since the early 1990s (Calambokidis et al., unpublished data).

Humpback whale abundance off northern Washington has increased steadily from 1995 to 2002 based both on line-transect surveys and on marking and recapture of identified whales (Calambokidis et al. 2004). Estimates indicate that several hundred whales use this feeding area, although whale interchange to other areas makes it difficult to establish a clear population estimate for this one region.

The Structure of Populations, Levels of Abundance, and Status of Humpbacks (SPLASH) project, a large collaborative effort to examine the status and population trends of humpback whales throughout the North Pacific (2004-2006), estimated abundances at about 20,000 humpback whales. Overall trends in abundance suggest a 5-7 percent annual increase since the end of whaling in the late 1960s (Calambokidis et al. 2008). Regional mark-recapture estimates within this study were 200-400 for Washington/south British Columbia and 1,400-1,700 for California-Oregon (Calambokidis et al. 2008).

The North Pacific population is still recovering from commercial whaling, which continued in U.S. waters until 1966 (Rice 1978; Clapham et al. 1997). The pre-whaling population size was roughly estimated to have been 15,000 (Rice 1978), and the population was thought to have been reduced to roughly 1,200 by the mid 1960s (Johnson and Wolman 1984). Substantial numbers of humpback whales were killed off the Washington and Oregon coasts; 1,933 humpback whales were landed at the Bay City (Grays Harbor) whaling station between 1911 and 1925 (Scheffer and Slipp 1948).

10.2.5.3 Foraging and Ecological Context

Humpback whales feed on both krill and small fish. Feeding strategies vary by region and year. Whaling data from San Francisco Bay in the 1950s and 1960s showed annual shifts in primary prey between krill (sometimes reported as shrimp) and small fish such as anchovies in stomachs of humpback whales taken off central California (Rice 1963).

Killer whales are predators of humpback whales. Humpback whales off California, Oregon, and Washington show some of the highest rates of scarring from killer whale attacks of any feeding area in the North Pacific (Steiger et al. 2008). Killer whales primarily attack calves in their first six months of life, with most of these attacks probably taking place on the wintering grounds. Some juvenile and adult humpback whales also show acquisition of the characteristic rake mark scars indicating they have survived attacks later in life.

10.2.5.4 Status/Threats

Humpback whales are listed as an endangered Species. Under the Marine Mammal Protection Act, the California/Mexico stock of humpback whales, which extends to northern Oregon coastal waters, are considered a strategic and depleted stock. While the population of humpback whales off the U.S. West Coast has been recovering, there have also been reports of below-normal reproductive rates observed in this population, although this could be largely the result of bias in the sampling method (Steiger and Calambokidis 2000).

10.2.6 North Pacific Right Whale (*Eubalaena japonica*)

10.2.6.1 Distribution and Migration

The North Pacific right whale is one of the most endangered species in the world (Wade et al. 2006). While little is known about their population structure, two stocks are currently recognized: the eastern and western North Pacific stocks (Rosenbaum et al. 2000; Brownell et al. 2001; Angliss and Allen 2008).

Sightings throughout the eastern North Pacific are exceedingly rare; between 1965 and 1999, there were only 82 sightings in the entire eastern North Pacific Ocean, primarily in the Bering Sea and off the Aleutian Islands (Brownell et al. 2001). Illegal whaling by the U.S.S.R. in the mid-1960s, when 372 right whales were killed in the eastern North Pacific, also has contributed to the paucity of sightings (Doroshenko 2000; Brownell et al. 2001). Just recently there was an encouraging finding: In 2004, a concentration of at least 17 was seen in a survey by Southwest Fisheries Science Center (SWFSC) in the Bering Sea (Wade et al. 2006).

Right whale wintering grounds probably extended from British Columbia to California prior to the decimation of this species by whalers in the early 1900s (Gilmore 1956; Pike and Macaskie 1969; Brownell et al. 2001). In the Northern Planning Area, seven rare sightings have occurred in this region since 1959: off Tillamook Head, Washington, in May 1959; off the Farallon Islands, California, in May 1963; off Cape Flattery, Washington, in January 1967; off Fort Bragg, California, in 1974; off San Francisco Bay in 1982; in the Strait of Juan de Fuca in 1983; and off Cape Elizabeth, Washington, in 1992 (Fiscus and Niggol 1965; Rice and Fiscus 1968; Reeves and Leatherwood 1985; Scarff 1986; Osborne et al. 1988; Rowlett et al. 1994; Brownell et al. 2001).

10.2.6.2 Abundance

There is no reliable estimate of northern right whale abundance in the eastern North Pacific. The most recent estimate for the North Pacific was suggested to be in the low hundreds based on a review of sightings (Brownell et al. 2001).

10.2.6.3 Foraging and Ecological Context

The northern right whales' diet is composed entirely of zooplankton, including copepods, euphausiids and even pteropods (tiny planktonic snails)(Hewitt and Lipsky 2002; Kenney 2002). Killer whales are northern right whales' only known predator, although few attacks on right whales have been witnessed (Kraus 1990; Kenney 2002).

10.2.6.4 Status/Threats

Brownell et al. (2001) state that the prognosis for northern right whales in the eastern North Pacific is poor. Federally listed as an endangered species, right whales are designated as depleted under the MMPA and classified as a strategic stock.

Entanglements and vessel collisions are a significant source of mortality for right whales in other regions; in the North Atlantic approximately one-third of all right whale mortality is human-

related (Kraus 1990). Entanglement mortality of northern right whales has also occurred in the western North Pacific (Brownell et al. 2001). Little is known about their vulnerabilities in the eastern North Pacific stock (Brownell et al. 2001; Angliss and Allen 2008). Clapham et al. (2004) suggest that the northern right whales' dependence on a highly specialized food source (copepods) may make this species less adaptable to major environmental shifts.

10.2.7 Gray Whales (*Eschrichtius robustus*)

10.2.7.1 Distribution and Migration

The eastern Pacific stock of gray whales ranges from its wintering grounds off Baja California, Mexico, to primary feeding grounds in the Bering and Chukchi Seas (Rice and Wolman 1971; Rice et al. 1984). Nearly the entire population migrates along the coastal waters of the U.S. West Coast during winter its southbound migration, and again in the spring traveling northbound (Herzing and Mate 1984).

Unlike other whale species, gray whales have a narrow migration route that is quite close to shore, which historically made this species an easier target for whalers. Today, this route also makes them potentially vulnerable to other human activities. The southbound migration corridor extends farther offshore than the northbound (Pike 1962; Braham 1984). Off the Washington coast, the southbound migration extends out to 40-50 km offshore; during the northbound migration, animals are seen migrating near shore and out to about 20 km offshore (Green et al. 1995).

Outside these migratory periods, summer feeding aggregations of gray whales have been reported to range from central California to southeastern Alaska (Darling 1984; Calambokidis et al. 2002). These animals generally have been referred to as summer or seasonal residents or more recently as the "Pacific Coast feeding aggregation," to avoid the misimpression that they do not migrate (Calambokidis et al. 2002).

In the Northern Planning Area, these aggregations have been seen regularly close to shore off Northern California (Patrick's Point to Point St George), off the Oregon coast and in Washington waters including the outer Washington coast, and in inland waters including Grays Harbor, the Strait of Juan de Fuca, and northern Puget Sound (Patten and Samaras 1977; Flaherty 1983; Darling 1984; Sumich 1984; Calambokidis et al. 2002; Calambokidis et al. 2004).

10.2.7.2 Abundance

Aboriginal whalers hunted gray whales sustainably for hundreds of years (Henderson 1984). The eastern North Pacific gray whale population was estimated to be between 15,000 and 25,000 animals for the early 19th century prior to commercial whaling (Henderson 1984). Between 1850 and 1880, the entire stock was hunted nearly to extinction by whalers; the remaining population probably numbered between a few hundred and 2,000 animals (Henderson 1984).

The overall abundance of the eastern North Pacific gray whale was just over 18,000 animals in 2001/2002 (Rugh et al. 2005). This was a substantial decrease from estimates of almost 30,000 whales in 1997-1998. The 1997-1998 estimate and the 2001-2002 estimate were found using the

same census methods (Rugh et al. 2005). While the 1997-1998 estimate may have been biased upwards, there appears to have been a real decline in abundance because of high mortality and low reproduction in 1999 and 2000 (Gulland et al. 2005). This mortality is likely the result of this population reaching carrying capacity (Rugh et al. 2005), and it appears that this trend was short-term; it is not believed to be continuing presently (Carretta et al. 2008). In the area that includes the Northern Planning Area (Northern California to southeastern Alaska) about 200 to 260 whales feed each summer (Calambokidis et al. 2009b).

10.2.7.3 Foraging and Ecological Context

The gray whale is the only baleen whale that regularly depends on benthic organisms for prey. Gray whales employ various methods for feeding, but most consistently use suction to consume organisms that reside in the substrate. Gray whales feed primarily on organisms along the bottom throughout their range (Murison et al. 1984; Nerini 1984; Oliver and Slattery 1985; Weitkamp et al. 1992). A wide variety of prey has been documented for gray whales, although the majority of the gray whale population feeds on ampeliscid amphipods in the Bering Sea (Nerini 1984). Killer whales are their only known natural predator (Jefferson et al. 1991).

10.2.7.4 Status/Threats

Under the Endangered Species Act of 1973, the eastern North Pacific stock of gray whales was listed federally as endangered, but that designation was changed in 1994, when the National Marine Fisheries Service and the U.S. Fish and Wildlife Service determined the stock should be delisted due to an increase in population size following several years of regulatory protection. Currently, Federal protection of this species is maintained under the Marine Mammal Protection Act, which prohibits the take (capture or harassment) of gray whales yet provides for limited harvest under certain circumstances, such as preexisting treaty rights of Native American tribes (e.g., Makah tribal subsistence hunting rights).

Gray whales have long been an important ceremonial and subsistence resource for several of the Northwest tribes, including the Makah, Quileute, Quinault, Hoh and Klallam tribes. In 1995, the Makah Tribe proposed resumption of their aboriginal hunt of gray whales primarily for cultural purposes. Since 1999, they have killed two animals amid much controversy. The hunt is currently suspended due to legal challenges (Calambokidis et al. 2009b).

Other causes of death include ship strikes, entanglement, and killer whale attacks (Sumich and Harvey 1986; Heyning and Dahlheim 1990; Baird et al. 2002; Douglas et al. 2008). Ship strikes, while they do occur, appear to be at a lower incidence for gray whales than for other large whale species (Douglas et al. 2008). An unusual mortality event occurred along the West Coast of North America in 1999 and 2000, when over 651 dead gray whales were recovered (compared to an annual mean of 41 animals); while starvation appeared to be the primary cause of death, the underlying cause was unclear (Gulland et al. 2005).

10.2.8 Sperm Whales (*Physeter macrocephalus*)

10.2.8.1 Distribution and Migration

Sperm whales are a deepwater species that inhabit the waters off the Continental Shelf and in deep water canyons (Whitehead 2002). While they are widely distributed in the North Pacific, little is known about their distribution, movements, and population structure. For management purposes, the International Whaling Commission (IWC) has divided sperm whales in the North Pacific into two management regions, although this boundary has not been reviewed in recent years (Donovan 1991). The National Marine Fisheries Service has divided sperm whale stocks into three discrete units: those inhabiting California, Oregon, and Washington waters; those inhabiting waters off Hawaii; and those inhabiting Alaskan waters (Carretta et al. 2008). While there is some genetic evidence of stock segregation between near shore and offshore sperm whales within the North Pacific (Mesnick et al. 1999), a survey of sperm whales in the temperate North Pacific between California and offshore to Hawaii did not reveal any clear breaks in distribution (Barlow and Taylor 2005).

The summer range for sperm whales includes all of the North Pacific and southern Bering Sea; in winter they are thought to occur south of lat. 40° N (Rice 1974; Gosho et al. 1984; Carretta et al. 2008). Off California, Oregon and Washington, sperm whales are generally found year-round (Dohl 1983; Green et al. 1992; Barlow 1995; Forney et al. 1995; Carretta et al. 2008). Discovery tags put in sperm whales off Southern California in winter from 1962 to 1970 were later retrieved in whales killed in Northern California (June), Washington (June) and British Columbia (April) (Rice 1974).

10.2.8.2 Abundance

While large numbers of sperm whales inhabit the North Pacific, population estimates are temporally variable (Barlow and Forney 2007). Because sperm whales tend to congregate in large groups, there is more variability in abundance estimates (Barlow and Forney 2007). Several estimates have been made for the region off California, Oregon and Washington and out 300 nmi: 1,407 (CV = 0.39) during summer/fall 1993 and 1996 (Barlow and Taylor 2001), 2,593 (CV = 0.30) in 2001, and 3,140 (CV = 0.40) in 2005 (Barlow and Forney 2007; Forney 2007; Carretta et al. 2008). Barlow and Forney (2007) speculate that the trends in increasing abundance may be due to the availability of giant squid in the region.

In the Northern Planning Area, regional abundance was estimated at 736 (CV = 0.40) for Northern California and 448 (CV = 0.63) for Oregon and Washington using pooled line-transect survey data from 1991 to 2005 (Barlow and Forney 2007).

10.2.8.3 Foraging and Ecological Context

Sperm whales prey on deepwater organisms, including numerous mesopelagic species of squid as well as noncephalopod prey, including fish (Whitehead 2002). Killer whales are sperm whales' only known natural predator; Pitman et al. (2001) document several witnessed attacks of sperm whales off the coast of Mexico and California.

10.2.8.4 Status/Threats

Sperm whales are listed as endangered under the Endangered Species Act, and therefore considered as a strategic stock. Some sperm whales have been entangled in fishing nets resulting in mortality (Carretta et al. 2008). Douglas et al. (2008) reported propeller wounds on a dead sperm whale off Washington State, but there is no other evidence that ship strikes are a concern (Carretta et al. 2008). Increasing levels of anthropogenic sound from ships and other man-made sources is a concern for most whale species, particularly the “deep-diving whales like sperm whales that feed in the ocean’s sound channel” (Carretta et al. 2008).

10.2.9 Kogia spp: Dwarf sperm Whales (*Kogia sima*) and Pygmy Sperm Whales (*Kogia breviceps*)

10.2.9.1 Distribution and Migration

Both dwarf sperm whales and pygmy sperm whales inhabit deepwater canyons and the waters just off the Continental Shelf (Ross 1984; Caldwell and Caldwell 1989; Carretta et al. 2008). Both species are difficult to sight and differentiate at sea; there were only nine sightings of *Kogia* spp. in surveys conducted between 1991 and 2005, but it is unclear if they were dwarf or pygmy sperm whales (Carretta et al. 2008). Most of the information about their occurrence comes from strandings. Strandings of pygmy sperm whales are not uncommon off the coasts of California, Oregon, and Washington. Strandings of dwarf sperm whales are rare; five had been reported off California between 1967 and 2000 (Carretta et al. 2008). It is possible that the low number of strandings may reflect the pelagic distribution of this species and not necessarily be an indication of abundance (Carretta et al. 2008).

Dwarf sperm whales, normally a warmer temperate and tropical species, have been documented as far north as the coast off British Columbia (Nargorsen and Stewart 1983). There are no data to examine movements, seasonality, or stock discreteness. The National Marine Fisheries Service divides animals into two stocks: those off California, Oregon and Washington, and those off Hawaii (Carretta et al. 2008).

10.2.9.2 Abundance

Due to the difficulty of identifying and differentiating dwarf sperm whales and pygmy sperm whales at sea, abundance estimates are made for the both species combined. For the U.S. West Coast, Barlow and Forney (2007) estimate 1237 (CV = 0.45) animals. In the Northern Planning Area, 130 (CV = 1.25) animals (*Kogia* spp.) were estimated for Northern California (north of Point Reyes) and 397 (CV = 1.25) off Oregon and Washington (Barlow and Forney 2007). Confidences are less precise because of the low sightability of these species.

10.2.9.3 Foraging and Ecological Context

Like sperm whales, these two deep-diving species tend to eat squid and also some fish, small sharks, and octopods (Perrin et al. 2002). Both are likely occasional prey of killer whales.

10.2.9.4 Status/Threats

Dwarf sperm whales and pygmy sperm whales are not listed under the Endangered Species Act. Because they are believed to be rare off the U.S. West Coast, and there is no history of fisheries interactions, they are not classified as a strategic stock under the Marine Mammal Protection Act (Carretta et al. 2008). Increasing levels of anthropogenic sound are a concern for these deep-diving species, particularly the impact of active sonar, which has been implicated in the strandings of beaked whales (Frantzis 1998; Balcomb and Claridge 2001; Barlow and Gisiner 2006; Cox et al. 2006).

10.2.10 Beaked Whales

10.2.10.1 Distribution and Migration

Beaked whales are among the least understood of all marine mammal species (Cox et al. 2006). There are several species of open-ocean beaked whales that are probably always found in the offshore waters of Washington, Oregon, and California, primarily in small numbers, although they are rarely seen due to their open ocean habits, long dive times, sometimes-cryptic surfacing behavior, and occasional avoidance of boats. These include four species of beaked whales: Baird's beaked whales (*Berardius bairdii*); Cuvier's beaked whales (*Ziphius cavirostris*); Stejneger's beaked whale (*Mesoplodon stejnegeri*); and Hubb's beaked whales (*Mesoplodon carlhubbsi*). These species have been documented both from stranding records (Norman et al. 2004; Carretta et al. 2008) and some from sightings (Carretta et al. 2008), although the *Mesoplodon* spp. are generally not distinguishable at sea. Other *Mesoplodon* species that could inhabit the waters off the U.S. West Coast include the Blainville's beak whale (*M. densirostris*), Perrin's beaked whale (*M. perrini*), lesser beaked whales (*M. peruvianus*), and the Ginkgo-toothed beaked whale (*M. ginkgodens*), although these four species tend to be found in warm temperate or tropical waters (Pitman 2002).

Along the U.S. West Coast, Baird's beaked whales are generally found along the Continental slope from late spring to early fall; fewer animals are seen farther offshore during winter and early spring (Carretta et al. 2008). Cuvier's beaked whales are encountered along the U.S. West Coast more often than other beaked whale species. There is no evidence of seasonal differences in distribution for the Cuvier's beaked whale or any of the *Mesoplodon* spp; these species are also found along the Continental slope or deep open ocean (Pitman 2002).

The National Marine Fisheries Service treats the beaked whales of the U.S. West Coast as separate stocks from those in other regions (Carretta et al. 2008). Because of the difficulties in distinguishing the different species, the *Mesoplodon* spp. are treated as one management unit.

10.2.10.2 Abundance

The abundance estimate for the U.S. West Coast for Baird's beaked whales is 1,005 (CV = 0.37); for Cuvier's beaked whales, 4,342 (CV = 0.58); and for all species of *Mesoplodon*, 1,177 (CV = 0.40)(which likely includes three additional species as well as Stejneger's and Hubb's)(Barlow and Forney 2007). In the Northern Planning Area, estimates for Baird's beaked whales are 200 (CV = 0.74) for Northern California (north of Point Reyes) and 520 (CV = 0.54) for Oregon and Washington; for Cuvier's beaked whales, 784 (CV = 1.18) for Northern California and 0 for

Oregon and Washington; and for the *Mesoplodon* spp., 341 (CV = 0.78) for Northern California and 435 (CV = 0.70) for Oregon and Washington (Barlow and Forney 2007). There are no data on trends on abundance on any of these species.

10.2.10.3 Foraging and Ecological Context

Most beaked whales prey on deepwater fishes and squid, feeding at depth of 200 m or more (Heyning 2002; Kasuya 2002; Pitman 2002). Predators likely include killer whales and large sharks although direct observations are lacking (Pitman 2002).

10.2.10.4 Status/Threats

None of the beaked whale species are listed as threatened or endangered. Naval exercises in a number of regions have been implicated as the cause of beaked whale mass stranding in a number of regions, including off Greece, the Bahamas, the Madeira Islands, the Canary Islands and the Gulf of California (Balcomb and Claridge 2001; Jepson et al. 2003; Brownell et al. 2004; Barlow and Gisiner 2006; Cox et al. 2006; Macleod and D'amico 2006).

10.2.11 Killer Whale (*Orcinus orca*)

10.2.11.1 Distribution and Migration

Although killer whales are found in all oceans and seas of the world, their density is greatest in colder waters within 800 km of major continents (Forney and Wade 2006). Off the West Coast of North America they are found in high density in near shore waters from Alaska to central California (Forney and Wade 2006).

Despite their broad distribution, there is extensive evidence of population subdivision of killer whales in the coastal temperate waters of the eastern North Pacific. Populations in this area can be broadly subdivided into fish-eating and mammal-eating forms or ecotypes, colloquially termed “resident” and “transient” respectively, although these designators are known to be misleading in terms of movement patterns. These fish-eating and mammal-eating populations are genetically and morphologically distinct (Bigg et al. 1987; Baird and Stacey 1988; Stevens et al. 1989; Hoelzel et al. 2002), and they differ in habitat use, vocalizations, social organization, and other aspects of behavior (Morton 1990; Baird and Whitehead 2000; Ford et al. 2000; Ford et al. 2005b). The fish-eating and mammal-eating forms of whales do not associate and may actively avoid one another (Baird and Dill 1995). Fish-eating killer whales are further subdivided into at least two and most likely three populations in Washington, colloquially termed “northern residents,” “southern residents,” and “offshores.” Individuals from each of these populations have not been known to associate with individuals from the others, and they differ in terms of acoustics, mitochondrial DNA, and core home ranges (Ford et al. 2000; Hoelzel et al. 2002). The so-called offshore population is not known to inhabit truly pelagic waters, but is generally found on the continental shelf. This population is closely genetically related (by mitochondrial DNA) to the fish-eating form (Hoelzel et al. 2002) and is known to eat fish (Jones 2006). The offshore population has been considered by some to be a third population of the fish-eating ecotype (Baird 2001) and has been noted by others as a third ecotype (Jones 2006), although no comprehensive assessment of differences in behavior and genetics has been made.

All three populations of fish-eating killer whales overlap in their ranges, although there are differences in the core areas the whales use, at least in summer months when their movements have been best monitored. While the core summer range of the northern resident population is centered in inshore central British Columbia (Johnstone Strait and surrounding areas), this population ranges at least as far south as the Washington/Oregon border and north to southeast Alaska. The core summer range of the southern resident population straddles the Washington-British Columbia border in inland waters, though this stock ranges as far north as northern British Columbia and as far south as central California, at least in winter. The offshore extent of both populations is unknown. The offshore population ranges from Southern California north to the Aleutians. Whales from this population are seen only infrequently in inshore waters (e.g., around the San Juan Islands), and they are thought to primarily inhabit shelf and possibly slope waters, though the offshore extent of the range is unknown.

Only a single population of mammal-eating killer whales, referred to as the “West Coast transient” population by NMFS, is known to use Washington waters (other populations of mammal-eating killer whales exist in Alaskan waters). The range of mammal-eating killer whales in Washington overlaps with all three populations of fish-eating killer whales, though their spatial and temporal use of shared waters differs (Heimlich-Boran 1988; Morton 1990; Baird and Dill 1995). The overall range of the population is in near shore waters from Southern California to southeast Alaska, with nothing known of the offshore extent of the range. Some individual mammal-eating killer whales have been documented with an overall range of 140,000 km² (Calambokidis and Baird 1994), and movements of individuals between California and Alaska have been documented (Black et al. 1997). Despite such movements, there appears to be some preferential area use by mammal-eating killer whales throughout their range, so that only a subset of the overall population may use Washington waters.

The majority of sightings of killer whales in inland Washington waters are of the southern resident stock of fish-eating killer whales. These whales utilize inshore waters of Juan de Fuca Strait, Haro Strait, Rosario Strait, Boundary Pass, and the southern Strait of Georgia on at least a weekly basis (and often a daily basis) for the summer and early fall each year (Osborne 1999; Hauser 2006). Whales from this stock use Puget Sound primarily during the fall, winter and spring. During the winter and spring more than half the population is rarely seen, and is thought to be primarily using waters on the outer coast from California to British Columbia. Sightings of whales from the northern resident stock are infrequent though they have been documented both in inshore waters (Haro Strait, Juan de Fuca Strait) and on the outer Washington coast (Calambokidis et al. 2004)(M.B. Hanson unpublished data). Outer Washington coast sightings of “northern residents” have been documented from March, July, September, and October. This population could use the waters off the outer coast on a regular basis without being detected, given the relatively low monitoring effort on the outer coast. Mammal-eating killer whales use Washington waters year-round, being recorded both in inland waters and on the outer coast. There is an influx of mammal-eating killer whales into inland waters in August and September each year (Baird and Dill 1995), coinciding with the harbor seal weaning and post-weaning period. Differences in habitat use between fish-eating and mammal-eating populations primarily involve mammal-eating killer whales utilizing small bays and channels more frequently (Heimlich-Boran 1988; Morton 1990; Baird and Dill 1995).

Although killer whales may be resident to some areas for extended periods, they also can range widely. Killer whales individually identified off California have been resighted as far north as British Columbia and Glacier Bay, Alaska, and as far south as San Benitos Islands, Mexico (Black et al. 1993).

10.2.11.2 Abundance

Population sizes for “northern residents” and “southern residents” have been established plus or minus a couple of individuals, based on direct counts of individually identifiable animals (Bigg et al. 1987; Ford et al. 2000). In 2005 the southern resident population was known to have 91 individuals, while in 2004 the northern resident population was known to have approximately 219 individuals (Ford et al. 2000; Ford et al. 2005b).

Population sizes of offshore and mammal-eating killer whales are not known with any precision. Direct counts of identifiable individuals for those populations are problematic as there are long time periods between resightings, and assessing whether individuals have died is not possible. The National Marine Fisheries Service estimates population size for the offshore population based on identified individuals (Ford et al. 2000; Ford et al. 2005b) at 211 individuals (Carretta et al. 2008), which is considered an underestimate because not all whales have been identified (Carretta et al. 2008). For the entire California-Oregon-Washington coast, a total of 1,014 (CV = 0.29) killer whales was estimated from line-transect surveys between 2001 and 2005 although this estimate does not distinguish among the different stocks (Barlow and Forney 2007).

In the Northern Planning Area, ship line-transects estimated overall abundance at 142 (CV = 0.47) whales off Northern California and 521 (CV = 0.37) off the outer coasts of Washington and Oregon (Barlow and Forney 2007).

10.2.11.3 Foraging and Ecological Context

Prey of killer whales includes a wide variety of fish, cephalopods, pinnipeds, and other cetaceans, as well as other prey such as birds, deer, and sea turtles (see reviews by Hoyt 1984; Jefferson et al. 1991; Perrin et al. 2002). In some areas, different forms of killer whales show very different prey preferences and feeding behavior (Bigg et al. 1987). Fish prey range from small schooling fishes, including herring and sardines, to large fish such as halibut and basking sharks (Hoyt 1984). Documented predation on marine mammals by killer whales has been observed for 20 species of cetaceans, 14 species of pinniped, sea otter, and dugong (Jefferson et al. 1991). These whales feed primarily on harbor seals, though they occasionally take Dall’s porpoises, harbor porpoises, California sea lions, Steller sea lions, and northern elephant seals (Baird and Dill 1995).

10.2.11.4 Status/Threats

The southern resident stock of killer whales was listed as endangered under the ESA in 2006. The northern resident population is not listed in U.S. waters under the ESA, nor is it listed as depleted under the MMPA, although it is listed as threatened under the Canadian Species at Risk Act (SARA). Neither the transient nor the offshore population is listed in U.S. waters under the ESA, nor are these populations listed as depleted under the MMPA.

10.2.12 Offshore Delphinids

10.2.12.1 *Distribution and Migration*

There are three other species of toothed whales that are relatively abundant and are found off the U.S. West Coast year-round: Pacific white-sided dolphins (*Lagenorhynchus obliquidens*); northern right whale dolphins (*Lissodelphins borealis*), and Risso's dolphins (*Grampus griseus*). Pacific white-sided dolphins and northern right whale dolphins are endemic to the temperate waters of the North Pacific, while Risso's dolphins are found worldwide in tropical and temperate waters. All three species are found on the Continental slope and shelf, as well as offshore, though along the U.S. West Coast, Pacific white-sided dolphins seem to be seen primarily in shelf and slope waters, while the other two species are also regularly seen in offshore waters (Leatherwood et al. 1982; Carretta et al. 2008). Seasonal north-south movements have been suggested for all three species (Carretta et al. 2008).

The National Marine Fisheries Service manages these species as one stock for the Washington, Oregon, and California region (Carretta et al. 2008). For Pacific white-sided dolphins, there appear to be at least two forms in the eastern Pacific, a northern and a southern form, with an overlap zone around lat. 32° - 37° N (Walker et al. 1984; Walker et al. 1986). For northern right whale dolphins, Dohl (1983) suggested that there might be separate populations off central and Northern California based on a gap in sightings between these two areas of concentration. For Risso's dolphins, there are several gaps in the north-south distribution of animals and also evidence of seasonal movements (Kruse 1989). These species often associate in mixed groups (Lipsky 2002).

10.2.12.2 *Abundance*

Population estimates for the waters of California, Oregon, and Washington are 23,817 (CV = 0.36) for Pacific white-sided dolphins, 11,097 (CV = 0.26) for northern right whale dolphins, and 11,910 (CV = 0.24) for Risso's dolphins (Barlow and Forney 2007).

Off Washington and Oregon, abundances were estimated at: 7,998 (CV = 0.37) for Pacific white-sided dolphins, 6,242 (CV = 0.26) for northern right whale dolphins, and 11,910 (CV = 0.24) for Risso's dolphins (Barlow and Forney 2007). In vessel surveys off the northern Washington coast Pacific white-sided dolphins were the most abundant cetacean encountered in terms of total number of individuals (Calambokidis et al. 2004).

10.2.12.3 *Foraging and Ecological Context*

Pacific white-sided dolphins prey on lantern fishes, anchovies, Pacific saury, Pacific hake, deep sea smelt, argentines and squid off California (Fiscus and Niggol 1965; Fitch and Brownell 1968; Stroud et al. 1981; Walker and Jones 1993; Waerebeek and Wursig 2002), and herring, salmon, cod, shrimp, and capelin off British Columbia (Heise 1997). Northern right whale dolphins tend to feed on squid as well as on lanternfish, Pacific hake, deepsea smelt, argentines, and Pacific saury (Fitch and Brownell 1968; Leatherwood et al. 1982; Walker and Jones 1993; Lipsky 2002). Risso's dolphins feed almost entirely on squid, most likely at night (Leatherwood

et al. 1982; Baird 2002). Offshore delphinids are known prey of killer whales (Jefferson et al. 1991).

10.2.12.4 Status/Threats

None of these species are listed under the ESA, and none of these stocks are considered depleted or strategic under the MMPA.

10.2.13 Other Tropical Delphinids

10.2.13.1 Distribution and Migration

Other tropical delphinids that at least occasionally have been documented in the Northern Planning Area include striped dolphins (*Stenella coeruleoalba*), short-beaked common dolphins (*Delphinus delphis*), bottlenosed dolphins (*Tursiops truncatus*), short-finned pilot whales (*Globicephala macrorhynchus*), and false killer whales (*Pseudorca crassidens*). All of these species are typically found only in warm temperate and tropical waters in the eastern North Pacific, and all but bottlenose dolphins are usually found in deeper offshore waters. These species are generally documented through stranding records (Ferrero and Tsunoda 1989; Norman et al. 2004). For example, striped dolphins have never been seen in waters off Oregon or Washington, but strandings have occurred in both regions (Carretta et al. 2008). Along the U.S. West Coast, two separate stocks of bottlenosed dolphins are recognized by the National Marine Fisheries Service: the California coastal stock and the California, Oregon, Washington offshore stock (Carretta et al. 2008). Dolphins of the offshore form have been documented as far north as lat. 41° N; these dolphins may move into Oregon and Washington waters in warm periods (Carretta et al. 2008). False killer whales have been sighted several times in inland waters (Scheffer and Slipp 1948; Osborne et al. 1988), and a lone individual was seen in inland waters regularly from the early 1990s until approximately 2004.

10.2.13.2 Abundance

For the U.S. West Coast, Barlow and Forney (2007) estimate abundances for short-beaked common dolphins (352,069, CV = 0.18), striped dolphins (18,976, CV = 0.28) and the short-finned pilot whale (350, CV = 0.48). For Oregon and Washington, these numbers are considerably lower: 4,555 (CV = 0.77) for common dolphins, 16 for (CV = 1.07) striped dolphins, and 0 for short-finned pilot whales (Barlow and Forney 2007). Coastal bottlenose dolphins generally do not occur north of San Francisco Bay but estimates of offshore bottlenose dolphins were 133 (CV = 0.68) for Northern California and 0 for Oregon-Washington (Barlow and Forney 2007). There have not been sightings of false killer whales in recent line-transect surveys off the U.S. West Coast preventing an estimate of abundance.

10.2.13.3 Foraging and Ecological Context

These five species all prey on a wide variety pelagic fishes and squid (Baird 2002; Leduc 2002; Olson and Reilly 2002; Perrin et al. 2002; Wells and Scott 2002); preferences vary by season and region (Perrin 2002). False killer whales have also been known to prey on smaller pelagic dolphins and, in one case, a humpback whale calf (Baird 2002; Balance 2002; Weller 2002). All of these species are potential prey of killer whales and possibly sharks (Balance 2002).

10.2.13.4 Status/Threats

None of these species are listed as threatened or endangered under the ESA or as depleted under the MMPA (Carretta et al. 2008).

10.2.14 Harbor Porpoise (*Phocoena phocoena*)

10.2.14.1 Distribution and Migration

The harbor porpoise is found in coastal waters throughout the temperate eastern North Pacific. There is considerable evidence of population subdivision in this species along the West Coast of North America, based on pollutant ratios (Calambokidis and Barlow 1991) and genetics (Rosel et al. 1995; Chivers et al. 2002). The National Marine Fisheries Service currently recognizes two stocks within Washington waters, a “Washington Island Waters Stock” and an “Oregon/Washington Coast Stock,” with a boundary between the two at Cape Flattery at the mouth of Juan de Fuca Strait (Carretta et al. 2008). Recent genetic evidence (Chivers et al. 2002) suggests that there is further population structure within inland waters of Washington, with genetic differentiation between the area around the San Juan Islands/southern Vancouver Island and Neah Bay in Juan de Fuca Strait, as well as between Neah Bay and Spike Rock on the outer Washington coast.

10.2.14.2 Abundance

Harbor porpoises were once abundant in the southern part of Puget Sound (Scheffer and Slipp 1948), although they are almost absent from that area today (Calambokidis et al. 1992; Osmek et al. 1996). Harbor porpoises were the most frequently recorded cetacean, in terms of both number of sightings and number of individuals, in aerial surveys in Washington in 2002 and 2003 covering inland and outer coast waters (Chandler and Calambokidis 2003b; Chandler and Calambokidis 2003a). An abundance estimate for inland waters from these surveys (including adjoining areas in southern British Columbia), corrected for availability and perception bias, was 10,682 (CV = 0.38) (J. Laake unpublished). For the 2002 survey of the outer coast (Chandler and Calambokidis 2003b), including waters of Oregon, Washington, and southern British Columbia out to 200 m depth, the estimated abundance when correction factors are applied is 37,745 (CV = 0.38) (Carretta et al. 2008). While population trend data are limited there have been some indication of an increase in abundance in Washington inland waters, with the estimate from 2002 and 2003 being significantly greater than the estimate in the 1990s (Carretta et al. 2008).

10.2.14.3 Foraging and Ecological Context

The harbor porpoise in Washington has a diverse diet of small fish and squid, and at least occasionally also feeds on crustaceans and polychaetes (Walker et al. 1998). There is considerable overlap in diet with Dall’s porpoise (Walker et al. 1998), although there are some differences in habitat use between the two species in inshore waters (Baird and Guenther 1995). Hybridization with Dall’s porpoise occurs fairly frequently in inland waters (Baird et al. 1998; Willis et al. 2004). Predators in Washington include mammal-eating killer whales (Baird and Dill 1995) and large sharks (Baird and Guenther 1995).

10.2.14.4 Status/Threats

The harbor porpoise is not listed under the Endangered Species Act and neither the Washington inland waters stock nor the Oregon/Washington coast stock is listed as strategic or depleted under the MMPA. Harbor porpoise are prone to mortality from entanglement in fishing nets, and this has been documented in Washington, especially in association with some tribal set-net fisheries in the late 1990s (Gearin et al. 1994).

10.2.15 Dall's Porpoise (*Phocoenoides dalli*)

10.2.15.1 Distribution and Migration

Dall's porpoise are commonly found in shelf, slope, and offshore waters off the West Coast of North America. The National Marine Fisheries Services considers a single stock along the entire coast of Washington through California, although it is possible that more than one stock may exist. In Washington they are common in inland waters of Juan de Fuca Strait, Haro Strait, the southern Strait of Georgia, and northern Puget Sound, as well as along the outer coast in shelf, slope and offshore waters.

10.2.15.2 Abundance

Estimates of abundance exist both for inland Washington waters and for the outer coast of Washington, Oregon, and California. Ship transect abundance estimates are difficult for this species, due to their attraction to vessels (Turnock and Quinn 1991), but surveys by Barlow and Forney (2007) minimized this bias, considering behavior in their estimates. Off California, Oregon, and Washington, estimates were 85,955 (CV = 0.45) for ship surveys between 1991 and 2005 (Barlow and Forney 2007). Regional estimates were 27,410 (CV = 0.256) for Northern California and 48,950 (CV = 0.71) for Oregon and Washington (Barlow and Forney 2007). The estimate for inland Washington waters from aerial surveys is 900 (CV = 0.40) individuals (Calambokidis et al. 1997). No information is available on population trends.

10.2.15.3 Ecological Context

The diet of Dall's porpoise in Washington waters consists primarily of a diversity of small fish, although cephalopods and a small number of crustaceans and polychaetes have also been documented (Walker et al. 1998). There is considerable overlap in diet with harbor porpoise (Walker et al. 1998) in inland waters. Dall's porpoise regularly hybridize with harbor porpoise in inland waters (Baird et al. 1998; Willis et al. 2004), although there are differences in habitat use in areas where they overlap (Baird and Guenther 1995). Dall's porpoise have been documented as prey of killer whales (Jefferson et al. 1991; Weller 2002).

10.2.15.4 Status/Threats

The California/Oregon/Washington stock of this species has not been listed under the ESA and is not considered a depleted or strategic stock under the MMPA. Dall's porpoise does not have a State status.

10.2.16 Harbor Seals

10.2.16.1 *Distribution and Migration*

Harbor seals are widely distributed in coastal waters all along the U.S. West Coast and into protected waters and estuaries throughout their range. Harbor seals are thought to be non-migratory although seasonal movements in the hundreds of km have been documented in some regions. Despite these movements there has been evidence of geographic structure among areas based on mitochondrial DNA, timing of births, pelage coloration, and contaminant concentrations (Kelly 1981; Calambokidis et al. 1985; Huber et al. 1994; Tempte 1994; Westlake and O'corry-Crowe 2002; O'corry-Crowe et al. 2003).

NMFS recognizes several management stocks of harbor seals along the U.S. West Coast including: (1) California, (2) outer coasts of Oregon and Washington, and (3) inland waters of Washington. The Northern Planning Area would encompass stocks from parts of both California and the outer coast of Oregon/Washington. Along the coast from Bodega Bay to Washington State, harbor seals are widely distributed in coastal waters and embayments and estuaries all along the coast. Haul-out areas used for resting and giving birth to pups and nursing include exposed rocks, islands, and beaches, as well as sand flats in estuaries. Major concentrations of seals are found in San Francisco Bay, Bolinas Lagoon, Double Point, Drakes Estero, Humboldt Bay, and Point St George off California; Cape Blanco and Umatilla Reefs, Rogue River, Coos Bay, Winchester Bay, Netards Bay, Alsea Bay, Tillamook Bay, Columbia River, off Oregon; Willapa Bay, and Grays Harbor off Washington. Some of these estuary areas are more intensely used seasonally.

10.2.16.2 *Abundance*

Harbor seals utilize numerous small haul-out areas, where they rest typically during low tide cycles. Typically these consist of sand spits, tide flats, rocks, beaches, and sometimes human-made structures like docks, floats, or log booms. Most of the censuses of harbor seals have been conducted based on counts of seals utilizing these haul-out areas, typically based on aerial surveys conducted at low tide during either the molt or the pupping season, when counts are highest. These counts have been calibrated typically with satellite- or radio-tagged animals to determine a correction factor for the proportion not hauled out. Details of the locations of all haul-out areas are published for some areas (Jefferies et al. 2000; Lowry et al. 2005).

Harbor seal abundance has increased with protection since the 1970s (Calambokidis et al. 1979; Jefferies et al. 2003). Censuses of harbor seals off Oregon and Washington from 1980 through 1999 (Jefferies et al. 2003) showed a steady increase as populations recovered through the early 1990s and then a stabilization of the population. The most recent population estimate for harbor seals is 16,165 for Oregon and Washington (Carretta et al. 2007) and 34,233 for all of California (Carretta et al. 2008). Lowry et al. (2005) provide a breakdown by region and 0.5 degree latitude sections for California, although these do not include the correction factor used by Carretta et al. (2008) to estimate total population size.

10.2.16.3 Foraging and Ecological Context

Harbor seals are considered opportunistic feeders, taking advantage of a wide variety of prey. Prey of harbor seals often varies between regions and seasons, reflecting differences in what is abundant and easy to catch. Harbor seals have been known to take commercially valuable fish and they were the object of programs to reduce their numbers because of this. More recent research has demonstrated that harbor seals take only small numbers of commercially valuable fish and take primarily either fish feeding near the mouths of rivers when salmon are running or fish that are already hooked or caught in gill nets. Harbor seals are known prey of killer whales and sharks (Scheffer and Slipp 1944; Jefferson et al. 1991; Weller 2002).

10.2.16.4 Status/Threats

While there does not exist good data on historical harbor seal abundance, populations along the U.S. West Coast appear to have reached equilibrium carrying capacity and have stabilized. These may even approach some of the levels reported earlier for some of these areas (Scheffer and Slipp 1944) although this is hard to evaluate overall. Harbor seals are not considered threatened or endangered under the ESA and are no longer considered depleted under the MMPA (Carretta et al. 2008).

Harbor seals are killed incidentally to a variety of fishing operations along the U.S. West Coast. A wide variety of human-related causes of death have been documented in harbor seals along the U.S. West Coast, including entanglement in fishing nets, shooting, and other trauma. High levels of contaminants have also been documented in harbor seals from some areas. None of these appear to have prevented the population from recovering. Harbor seals could be more vulnerable to future disease outbreaks as a result of immune suppression from contaminant concentrations.

10.2.17 California Sea Lions

10.2.17.1 Distribution and Migration

California sea lions occur in the eastern North Pacific. NMFS breaks these into three stocks, two of them in Mexico and one ranging from Southern California into waters off British Columbia (Carretta et al. 2008). California sea lions breed off Mexico and Southern California with primarily males migrating north during the nonbreeding season. While there is some interchange among these areas, especially adult males from Baja coming into U.S. waters, there are also some indications of genetic differences between sea lions in the different areas. California sea lions in Northern California, Oregon, and Washington are almost exclusively males that migrate north to feed during the nonbreeding season.

Off Northern California, Oregon, and Washington, California sea lions feed primarily in coastal waters and haul out primarily on jetties, offshore rocks and islands, log booms and rafts, and docks. The portion of the population migrating north into Washington and British Columbia has been estimated as 3,000-5,000 (Jefferies et al. 2000). There are no breeding grounds in this region, which are all located in Mexico and Southern California. Major haul-out areas for California sea lions in this region include San Francisco Bay, Point St George, Columbia River, Split Rock, Carroll Island, Cape Alava area, Tatoosh Island, and Everett Harbor/Port Gardner.

10.2.17.2 Abundance

California sea lion populations have increased steadily since protection began. The California stock is estimated to number 238,000 based on an extrapolation from the estimated 55,519 pups born in 2005 (Carretta et al. 2008). Alternately, a minimum population of 141,842 was determined from counts of all age and sex classes ashore at major rookeries and haul-out areas during July 2005, at the end of the breeding season. During the nonbreeding season some additional adult males from Mexico likely come into U.S. waters.

Trends in California sea lion pup production show the strong influence of El Niño events, which dramatically reduced pup production in 1983-4, 1992-3, 1998, and 2003 (Carretta et al. 2008). In most cases these El Niño events primarily altered pup production and survival, and these recovered afterward, but in some cases, like 1983-4, adult survivorship was also affected. Trends in pup counts (excluding El Niño years) indicated the population may have reached maximum net productivity (population level with largest increase in abundance) in 1997 and the population may have now reached carrying capacity (Carretta et al. 2008).

10.2.17.3 Foraging and Ecological Context

California sea lions feed on a diverse diet of fish and squid. Primary prey includes anchovy, sardines, mackerel, rockfish, and market squid. They feed both solitarily and in large aggregations. They frequently interact with a wide variety of commercial and recreational fishing operations. In many types of net-fishing operations, California sea lions have learned to take fish out of the nets or take bites out of them. In areas where salmon and steelhead migrations up river systems are constrained by dams and locks, California sea lions have learned to prey on the fish, which have little cover and a limited passageway. California sea lions are preyed upon by killer whales and sharks (Jefferson et al. 1991; Weller 2002).

10.2.17.4 Status/Threats

California sea lions are not listed under the ESA, and they are not considered depleted under the MMPA. As the population approaches carrying capacity increased mortality has also been observed in recent years from a variety of sources including leptospira outbreaks, demoic acid toxicity, and hookworm infestations.

California sea lions, partly as a result of their frequent interactions with humans, often are subject to a variety of human-caused injuries and mortalities. California sea lions' interaction with commercial and recreational fishing operations has resulted in numerous injuries and deaths of animals due to entanglement in fishing gear. A wide range of fisheries are involved. Predation by California sea lions on endangered salmon populations has resulted in a program of capture and now lethal removal of some animals. Examinations of stranding animals have revealed a range of other human-caused mortalities including from shootings and boat collisions.

10.2.18 Steller Sea Lion

10.2.18.1 *Distribution and Migration*

Steller sea lions (sometimes called northern sea lions) are widely distributed from California around the Pacific Rim to northern Japan (Carretta et al. 2008). Steller sea lions in U.S. waters have been divided for management into an eastern and a western stock, divided at longitude 144° W, although there has been disagreement over the location. Steller sea lions are considered nonmigratory although there are extensive movements in some areas. There appears to be a high site fidelity to natal rookery.

Steller sea lions utilize coastal waters from Northern California but have declined in their use of the southern end of their range, the former breeding colony at the Farallon Islands. Critical habitat recognized by NMFS for Steller sea lions within the study area includes rookeries at Southeast Farallon Island, Sugarloaf Island and Cape Mendocino off Northern California, and Pyramid, Long Brown and Seal Rocks off Southern Oregon. These critical habitats include an aquatic zone that extends 3,000 feet seaward from these locations and extends to an air zone 3,000 feet above them.

10.2.18.2 *Abundance*

The total population size of the eastern stock of Steller sea lions (California through SE Alaska) is extrapolated from pup counts taken from 2002 to 2005 and was 45,095 to 55,832 depending on the correction factor used (Carretta et al. 2008). The majority of this population is in British Columbia and southeast Alaska.

10.2.18.3 *Foraging and Ecological Context*

Steller sea lions feed on a wide variety of fish as well as invertebrates. Important prey items include various cod, mackerel, squid, octopus, herring, flatfish, and sculpins. Southern sea lions are known to prey on commercially valuable species of fish such as salmon, especially around river mouths when salmon are concentrating. Steller sea lions are known prey of killer whales and sharks (Jefferson et al. 1991; Weller 2002).

10.2.18.4 *Status/Threats*

Steller sea lions have undergone serious declines in several parts of their range. The western U.S. stock is now recognized as endangered under the ESA as well as depleted under the MMPA, as a result of a dramatic decline since the 1970s. The causes of this decline have been the subject of intense investigation. One of its primary suspected causes is the depletion of pollock due to the commercial midwater trawl fishery, which takes away one of the primary prey species of Steller sea lions. Other studies have suggested that a broader regime shift has played a role in the decline by forcing sea lions to shift to a less ideal diet (Trites and Donnelly 2003). Killer whale predation has also been suggested as a cause for the decline (Springer et al. 2003).

The eastern U.S. stock of Steller sea lions has fared better, although as mentioned above, there have been declines at the southern end of the range in California. The eastern U.S. stock is listed

as threatened under the ESA and depleted under the MMPA. Critical habitat under the ESA has been designated for some of the rookeries in California and southern Oregon.

10.2.19 Northern Elephant Seal

10.2.19.1 *Distribution and Migration*

Northern elephant seals utilize breeding areas primarily off California and Mexico, but they range much more widely for feeding, with males moving into the North Pacific and into the Gulf of Alaska and females generally staying south of lat. 45° N (Stewart and Huber 1993). NMFS recognizes a California breeding stock for the sake of management in U.S. waters (Carretta et al. 2008). The breeding season is generally December through March (Stewart and Huber 1993). Adults also return to land between March and August to molt. Northern elephant seals breed on islands off the coast of Mexico, in Southern California (Channel Islands), and in central California (Año Nuevo Island and mainland, southeast Farallon Islands, and Point Reyes). During the nonbreeding season, they range along the coast of Oregon, Washington and Alaska, as far north as the Gulf of Alaska and west to the Aleutian Islands (Condit and Le Boeuf 1984; Delong and Stewart 1991; Reeves et al. 1992). The animals make two foraging migrations each year, with males traveling to the Gulf of Alaska and along the Aleutian Islands and females visiting areas farther south offshore of Washington and Oregon (Stewart and Delong 1990).

Major breeding areas for northern elephant seals north of San Francisco Bay include the Farallon Islands. Elephant seals occasionally haul out, especially during molt, up and down the coasts of California, Oregon, and Washington. Elephant seals have been reported hauling out year-round at Cape Arago, Oregon (near Coos Bay). Occasionally elephant seals are born in some of these areas, including a birth in 2009 as far north as Race Rocks off Vancouver Island, British Columbia.

10.2.19.2 *Abundance*

Northern elephant seals were reduced to a few hundred individuals by hunting (Stewart and Huber 1993). The population has made a strong recovery and was estimated to number 124,000 in 2005 (Carretta et al. 2008), based on pups born and a multiplier for other age groups (Stewart et al. 1994).

10.2.19.3 *Foraging and Ecological Context*

Northern elephant seals primarily eat vertically migrating epipelagic and mesopelagic squid, in addition to Pacific whiting, cusk-eels, rockfish, sharks, rays, and ratfish (Condit and Le Boeuf 1984; Delong and Stewart 1991; Sinclair 1994). Recent data on adult males and females show they feed in deep waters seaward of the continental slope, repeatedly making long, deep dives (Le Boeuf et al. 1986; Reeves et al. 1992). Natural predators are killer whales and white sharks (Jefferson et al. 1991; Weller 2002).

10.2.19.4 *Status/Threats*

The reduction of northern elephant seals to a few tens or hundreds of animals has resulted in a low level of genetic variation in the remaining population, potentially making them more

vulnerable to new threats. Northern elephant seals are occasionally taken in low numbers in the California or Oregon thresher shark/swordfish drift gillnet fishery. Given their successful population recovery, northern elephant seals are not listed under the ESA and are not considered depleted under the MMPA.

10.2.20 Northern Fur Seal

10.2.20.1 *Distribution and Migration*

Northern fur seals breed on Robben Island, Japan; the Kuril and Commander Islands, Russia; the Pribilof Islands and Bogoslof Island, Alaska; and San Miguel Island, California. Females and juveniles from the primary breeding grounds in Alaska migrate south along the West Coast of North America after the summer breeding season to areas off the coast of British Columbia, Washington, Oregon, and California. In the winter and spring, large numbers of fur seals, primarily migrants from the Bering Sea populations, feed along the California coast beyond the edge of the continental shelf (Fiscus and Kajimura 1969; Bonnell et al. 1980). Animals from a small breeding colony on San Miguel Island, in the Southern California Bight, also feed off the U.S. West Coast.

For the sake of management, NMFS recognizes two stocks of northern fur seals using U.S. waters: an eastern Pacific stock, which breeds in the Pribilof Islands and migrates during winter months to waters of Alaska, British Columbia, Washington, Oregon, and California; and a San Miguel Island stock, which breeds on San Miguel Island and feeds off the U.S. West Coast (Carretta et al. 2008).

Waters off Northern California, Oregon, and Washington would be used by Northern fur seals from both the eastern North Pacific stock, which breeds primarily in the Bering Sea, and the San Miguel Island stock. Northern fur seals in Washington were seen primarily in the deep waters off the continental shelf (Oleson et al. 2009). Animals would be most abundant in these areas during the nonbreeding season (winter and spring).

10.2.20.2 *Abundance*

Abundance of northern fur seals in the eastern North Pacific stock has been declining since the early 1970s, when the total population was estimated at 1.25 million. Current estimates are about half this number, 665,550, extrapolated from the number of pups born (Carretta et al. 2008). The San Miguel Island stock has generally been increasing, except for declines during El Niño events, and is estimated at just under 10,000 as of 2005 (Carretta et al. 2008). Declines in the population of this species in the last 30 years have been attributed to a variety of factors including the long-term effects of a kill of young females in the 1950s and 1960s (York and Hartley 1981), entanglement in discarded pieces of nets (Fowler 1982), ecosystem changes, and killer whale predation (Springer et al. 2003).

10.2.20.3 *Foraging and Ecological Context*

Northern fur seals have been documented feeding on 53 species of fish and 10 species of squid (Kajimura 1984). Primary prey in northern waters was herring, capelin, sandlance, sablefish, and pollock (Kajimura 1984). Off California, primary prey was anchovy, whiting, saury, rockfish,

and jack mackerel (Kajimura 1984). Predominant prey of fur seals examined on San Miguel Island in the Southern California Bight was whiting, Californian lanternfish, several species of squids, jack mackerel, and anchovy (Antonelis et al. 1990; DeLong and Antonelis 1991). Natural predators are killer whales and sharks (Weller 2002)

10.2.20.4 Status/Threats

Although not listed under the ESA, northern fur seals of the eastern North Pacific stock are considered depleted under the MMPA due to the decline in abundance that has occurred. The San Miguel stock is not considered depleted under the MMPA.

10.2.21 Guadalupe Fur Seal

10.2.21.1 Distribution and Migration

Guadalupe fur seals primarily breed at Isa Guadalupe in Mexico. Thought to have gone extinct, this species has increased in numbers. Their range was thought to extend north only to the Southern California Bight, but more recent evidence has revealed both a current and a historical occurrence well into Washington waters. Standings of 19 Guadalupe fur seals occurred along the Washington and Oregon coast in summer 2007 (NMFS, unpublished report requesting closure on unusual mortality event). A reported on reanalysis of fur seals remains at Ozette, a Makah archaeological site on the northern Washington coast (Calambokidis et al. 1987), found that 0-4 percent of fur seal remains were of Guadalupe fur seals, indicating common occurrence there historically. Both the recent strandings and the historical remains were primarily of juvenile animals.

10.2.21.2 Abundance

The most recent abundance estimate for this species is based on pup counts from 1993 and indicates an estimated total abundance of 7,408 (Carretta et al. 2008).

10.2.21.3 Foraging and Ecological Context

Guadalupe fur seals are thought to feed primarily at night on pelagic squid, lanternfish, and mackerel. Natural predators are killer whales and sharks (Weller 2002)

10.2.21.4 Status/Threats

The Guadalupe fur seal was listed as threatened throughout its range in 1985 under the Endangered Species Act and is also protected under the Marine Mammal Protection Act, as amended. In 1975, the government of Mexico declared Guadalupe Island a pinniped sanctuary. NMFS has classified the U.S. Guadalupe fur seal stock as a strategic stock.

10.2.22 Sea Otter

10.2.22.1 Distribution and Migration

The historic range of the sea otter encompassed the temperate coastal waters of the North Pacific Rim from northern Japan, through Russia, Alaska, British Columbia, Washington, and Oregon to California. Two centuries of commercial exploitation reduced the range to small scattered

groups in Russia, the Aleutian Islands, the Alaska Peninsula, the Kodiak Archipelago, Prince William Sound, and California. Attempts to reestablish populations by translocation on the Pribilof Islands and in Southeast Alaska, British Columbia, Washington, and Oregon have been variably successful, with apparent failure in Oregon and on the Pribilof Islands (Jameson et al. 1982; Jameson et al. 1986). The success of a recent translocation to San Nicolas Island, California, is still undetermined (Rathbun et al. 1989; Reidman and Estes 1990).

For management purposes, the U.S. Fish and Wildlife Service considers there to be two stocks of sea otters on the U.S. West Coast: the California stock of the southern sea otters, which historically occurred in this region, and a Washington stock of the northern sea otters, which were translocated from Aleutians in the 1970s (Lance et al. 2004).

The Washington stock of sea otters generally occupies northern Washington waters from Destruction Island to Pillar Point (Lance et al. 2004), all north of the Northern Planning Area. Sea otters used to occupy waters off southern Washington within the Northern Planning Area, but there have been occasional only sightings of sea otters off Oregon and southern Washington; these are presumed to be stragglers from the Washington population (Lance et al. 2004).

10.2.22.2 Abundance

The northern sea otter in Washington State was estimated at 503-743 from 2000 to 2004 and was growing at an annual rate of 8.2 percent (Lance et al. 2004). Other than occasional stragglers, all of this population is north of the Northern Planning Area.

10.2.22.3 Foraging and Ecological Context

The diet of the sea otter varies considerably among individuals and in California consists mainly of abalone, red sea urchins, and rock crabs (Riedman and Estes 1990). Otters in this region also consume kelp crabs, various species of clams, turban snails, mussels, octopus, sea stars, fat innkeeper worms, chitons, and seabirds (Estes et al. 1982; Riedman and Estes 1990). Sea otters in the Northern Planning Area rarely prey on fish, in contrast to that of sea otters in Russia and Alaska, where epibenthic fish were also commonly consumed. Natural predators are killer whales and sharks (Weller et al. 2006).

10.2.22.4 Status/Threats

The Washington Stock of sea otters is not listed under the Federal ESA but is designated as endangered by the State of Washington. It is considered below optimum sustainable population (OSP) under the MMPA. Sea otter populations in Alaska have undergone declines since the 1980s. The cause and magnitude of these declines have been debated, with one line of evidence pointing to predation by killer whales as the primary cause (Springer et al. 2003). Sea otters are considered more vulnerable to oil contamination than other marine mammals because of their dependence on dense underfur for insulation (Siniff et al. 1982). Sea otter mortality from exposure to oil can come through consumption of oil during grooming or from hypothermia as a result of loss of insulation.

10.3 LIST OF LITERATURE CITED—MARINE MAMMALS

- Aguilar, A. 2002. Fin whale, *Balaenoptera physalus*. In: W.F. Perrin, B. Wursig and J.G.M. Thewissen. Encyclopedia of Marine Mammals. San Diego: Academic Press. 435-438 pp.
- Angliss, R.P. and B.M. Allen. 2008. North Pacific right whale (*Eubalaena japonica*) In: Alaska Marine Mammal Stock Assessments, 2008. U.S. Dept of Commerce, NOAA Technical Memorandum NMFS-AFSC-193. 188-193 pp.
- Antonelis, G.A., B.S. Stewart and W.F. Perryman. 1990. Foraging characteristics of female northern fur seals (*Callorhinus ursinus*) and California sea lions (*Zalophus californianus*). Canadian Journal of Zoology 68: 150-158.
- Baird, R.W. 2001. Status of killer whales in Canada. Canadian Field-Naturalist 115: 676-701.
- Baird, R.W. 2002. Risso's dolphin, *Grampus griseus*. In: W.F. Perrin, B. Wursig and J.G.M. Thewissen. Encyclopedia of Marine Mammals. San Diego: Academic Press.
- Baird, R.W. and L.M. Dill. 1995. Occurrence and behavior of transient killer whales: seasonal and pod-specific variability, foraging behavior and prey handling. Canadian Journal of Zoology 73: 1300-1311.
- Baird, R.W. and T.J. Guenther. 1995. Account of harbour porpoise (*Phocoena phocoena*) strandings and bycatches along the coast of British Columbia. Report for the International Whaling Commission Special Issue 16: 159-169.
- Baird, R.W. and P.J. Stacey. 1988. Variation in saddle patch pigmentation in populations of killer whales (*Orcinus orca*) from British Columbia, Alaska, and Washington State. Canadian Journal of Zoology 66 (11): 2582-2585.
- Baird, R.W., P.J. Stacey, D.A. Duffus and K.M. Langelier. 2002. An evaluation of gray whale (*Eschrichtius robustus*) mortality incidental to fishing operations in British Columbia, Canada. Journal of Cetacean Research and Management 4 (3): 289-296.
- Baird, R.W. and H. Whitehead. 2000. Social organization of mammal-eating killer whales: group stability and dispersal patterns. Canadian Journal of Zoology 78: 2096-2105.
- Baird, R.W., P.M. Willis, T.J. Guenther, P.J. Wilson and B.N. White. 1998. An intergeneric hybrid in the family Phocoenidae. Canadian Journal of Zoology 76 (1): 198.
- Baker, C.S., S.R. Palumbi, R.H. Lambertson, M.T. Weinrich, J. Calambokidis and S.J. O'Brien. 1990. Influence of seasonal migration on geographic distribution of mitochondrial DNA haplotypes in humpback whales. Nature 344: 238-240.
- Baker, C.S., R.W. Slade, J.L. Bannister, R.B. Abernethy, M.T. Weinrich, J. Lien, J. Urban, P. Corkerson, J. Calambokidis, O. Vasquez and S.R. Palumbi. 1994. Hierarchical structure of

- mitochondrial DNA gene flow among humpback whales *Megaptera novaeangliae*, worldwide. *Molecular Ecology* 3: 313-327.
- Balance, L.T. 2002. Cetacean ecology. In: W.F. Perrin, B. Wursig and J.G.M. Thewissen. *Encyclopedia of Marine Mammals*. San Diego: Academic Press. 208-214 pp.
- Balcomb, K. and D.E. Claridge. 2001. A mass stranding of cetaceans caused by naval sonar in the Bahamas. *Bahamas Journal of Science* 5: 2-12.
- Barlow, J. 1994. Abundance of large whales in California coastal waters: a comparison of ship surveys in 1979/80 and in 1991. In: G. Donovan. *Forty-fourth Report of the International Whaling Commission*, Cambridge. 44: 51-56.
- Barlow, J. 1995. The abundance of cetaceans in California waters. Part 1: Ship surveys in summer and fall of 1991. *Fishery Bulletin* 93 (1): 1-14.
- Barlow, J. 1997. Preliminary estimates of cetacean abundance off California, Oregon, and Washington based on a 1996 ship survey and comparisons of passing and closing modes. N. U.S. Dept. of Commerce, NOAA. SWFSC Administrative Report LJ-97-11. 25 pp.
- Barlow, J. and K.A. Forney. 2007. Abundance and population density of cetaceans in the California Current ecosystem. *Fishery Bulletin* 105 (4): 509-526.
- Barlow, J. and R. Gisiner. 2006. Mitigating, monitoring and assessing the effects of anthropogenic sound on beaked whales. *Journal of Cetacean Research and Management* 7 (3): 239-249.
- Barlow, J. and B.L. Taylor. 2001. Estimates of large whale abundance off California, Oregon, Washington, and Baja California based on 1993 and 1996 ship surveys. U.S. Dept. of Commerce, NMFS. Southwest Fisheries Science Center, NOAA. LJ-01-03. 11 pp.
- Barlow, J. and B. Taylor. 2005. Estimates of sperm whale abundance in the northeastern temperate Pacific from a combined acoustic and visual survey. *Marine Mammal Science* 21 (3): 429-445.
- Bigg, M.A., G.M. Ellis, J.K.B. Ford and K.C. Balcomb. 1987. *Killer whales of the Pacific Northwest: their identification, genealogy and natural history*. Vancouver, B C: West Coast Whale Research.
- Black, N., A. Schulman, D.K. Ellifrit, D. Shearwater, A. Baldrige, R.L. Ternullo, D. Goley, J. Calambokidis and M. Webber. 1993. Photo-identification of killer whales off California, In: *Tenth Biennial Conference on the Biology of Marine Mammals*, Galveston. Society for Marine Mammal Biology.
- Black, N.A., A. Schulman-Janiger, R.L. Ternullo and M. Guerrero-Ruiz. 1997. *Killer whales of California and Western Mexico: a catalog of photo-identified individuals*. U.S. Dept. of Commerce, NOAA, Technical Memorandum NOAA-TM-NMFS-SWFSC-247. 180 pp.

- Bonnell, M.L., B. Le Boeuf, M. Pierson, D.H. Dettman, G.D. Farrens, C.B. Heath, R.F. Gantt and D.J. Larsen. 1980. Pinnipeds of the Southern California Bight. In: Marine Mammal and Seabird Surveys of the Southern California Bight Area 1975-1978. Final Report to U.S. U.S. Dept. of Interior, Minerals Management Service. 535 pp.
- Braham, H.W. 1984. Distribution and migration of gray whales in Alaska. In: M.L. Jones, S.L. Swartz and S. Leatherwood. The Gray Whale, *Eschrichtius robustus*. Orlando: Academic Press. 249-266 pp.
- Brownell, R.L., Jr, P.J. Clapham, T. Miyashita, and T. Kasuya. 2001. Conservation status of North Pacific right whales. Journal of Cetacean Research and Management (Special Issue) 2: 269-286.
- Brownell, R.L., T. Yamada, J.G. Mead and A.L. Van Helden. 2004. Mass strandings of Cuvier's beaked whales in Japan: U.S. naval link?. In: 56th Meeting of the International Whaling Commission, Sorrento, Italy. SC/56/E37: 10.
- Brueggeman, J.J., G.A. Green, K.C. Balcomb, C.E. Bowlby, R.A. Grotefendt, K.T. Briggs, M.L. Bonnell, R.G. Ford, D.H. Varoujean, D. Heinemann and D.G. Chapman. 1990. Oregon-Washington Marine Mammal Seabird Survey: information synthesis and hypothesis formulation. U.S. Dept. of Interior, Minerals Management Service.
- Calambokidis, J. and R.W. Baird. 1994. Status of marine mammals in the Strait of Georgia, Puget Sound and the Juan de Fuca Strait and potential human impacts, In: R.C.H. Wilson, R.J. Beamish, F. Aitkens, and J. Bell. Review of the marine environment and biota of Strait of Georgia, Puget Sound and Juan de Fuca Strait, Marine Sciences Panel of the British Columbia/Washington Environmental Cooperation Council. 282-300 pp.
- Calambokidis, J. and J. Barlow. 1991. Chlorinated hydrocarbon concentrations and their use from describing population discreteness in harbor porpoises from Washington, Oregon, and California. U.S. Dept., NOAA Technical Report NMFS 98: 101-110.
- Calambokidis, J. and J. Barlow. 2004. Abundance of blue and humpback whales in the eastern North Pacific estimated by capture-recapture and line-transect methods. Marine Mammal Science 20 (1): 63-85.
- Calambokidis, J., J. Barlow, J.K.B. Ford, T.E. Chandler and A.B. Douglas. 2009a. Insights into the population structure of blue whales in the eastern North Pacific from recent sightings and photographic identification. Marine Mammal Science, doi: 10.1111/j.1748-7692.2009.00298.x
- Calambokidis, J., J.D. Darling, V. Deecke, P. Gearin, M. Gosho, W. Megill, C.M. Tombach, D. Goley, C. Toropova and B. Gisborne. 2002. Abundance, range and movements of a feeding aggregation of gray whales (*Eschrichtius robustus*) from California to southeastern Alaska in 1998. Journal of Cetacean Research and Management 4 (3): 267-276.

- Calambokidis, J., J.R. Evenson, J.C. Cubbage, P.J. Gearin and S. Osmek. 1992. Harbor porpoise distribution and abundance off Oregon and Washington from aerial surveys in 1991.
- Calambokidis, J., R.D. Everitt, J.C. Cubbage and S.D. Carter. 1979. Harbor seal census for the inland waters of Washington, 1977-1978. *The Murrelet* 60 (3): 110-112.
- Calambokidis, J., E.A. Falcone, T.J. Quinn, A.M. Burdin, P.J. Clapham, J.K.B. Ford, C.M. Gabriele, R. Deduc, D. Mattila, L. Rojas-Bracho, J.M. Straley, B.L. Taylor, J. Urban-R, D. Weller, B.H. Witteveen, M. Yamaguchi, A. Bendlin, D. Camacho, K.R. Flynn, A. Havron, J. Huggins and N. Maloney. 2008. SPLASH: Structure of populations, levels of abundance and status of humpback whales in the North Pacific. Contract Report to U.S. Dept. of Commerce, NOAA, Cascadia Research, Olympia, WA.
- Calambokidis, J., A. Klimek and L. Schlender. 2009b. Summary of collaborative photographic identification of gray whales from California to Alaska for 2007. Contract Report to U.S. Dept. of Commerce, NOAA, Cascadia Research, Olympia, WA.
- Calambokidis, J., S. Osmek and J.L. Laake. 1997. Survey report for the 1997 aerial surveys for harbor porpoise and other marine mammals of Oregon, Washington and British Columbia outside waters. Contract Report to U.S. Dept. of Commerce, NOAA, Cascadia Research, Olympia, WA.
- Calambokidis, J., S.M. Speich, J. Peard, G.H. Steiger, J.C. Cubbage, D.M. Fry and L.J. Lowenstine. 1985. Biology of Puget Sound marine mammals and marine birds: population health and evidence of pollution effects. Contract Report to U.S. Dept. of Commerce, NOAA, Cascadia Research, Olympia, WA. 159 pp.
- Calambokidis, J., G.H. Steiger and J.C. Cubbage. 1987. Marine mammals in the southwestern Strait of Juan de Fuca: Natural history and potential impacts of harbor development in Neah Bay. Contract Report to U.S. Dept. of Commerce, USGS, Cascadia Research, Olympia, WA.
- Calambokidis, J., G.H. Steiger, J.C. Cubbage, K.C. Balcomb, C. Ewald, S. Kruse, R. Wells and R. Sears. 1990. Sightings and movements of blue whales off central California 1986-88 from photo-identification of individuals (*Balaenoptera musculus*). In: Report of the International Whaling Commission, Special Issue 12: 343-348.
- Calambokidis, J., G.H. Steiger, D.K. Ellifrit, B.L. Troutman and C.E. Bowlby. 2004. Distribution and abundance of humpback whales (*Megaptera novaeangliae*) and other marine mammals off the northern Washington coast. *Fishery Bulletin* 102 (4): 563-580.
- Calambokidis, J., G.H. Steiger, J.R. Evenson, K.R. Flynn, K.C. Balcomb, D.E. Claridge, P. Bloedel, J.M. Straley, C.S. Baker and O. Von Ziegesar. 1996. Interchange and isolation of humpback whales off California and other North Pacific feeding grounds. *Marine Mammal Science* 12 (2): 215-226.
- Calambokidis, J., G.H. Steiger, K. Rasmussen, J. Urban-R, K.C. Balcomb, P. Ladron De Guevara, M. Salinas-Z, J.K. Jacobsen, C.S. Baker, L.M. Herman, S. Cerchio and J.D.

- Darling. 2000. Migratory destinations of humpback whales that feed off California, Oregon and Washington. (*Megaptera novaeangliae*). Marine Ecology Progress Series 192: 295-304.
- Caldwell, D.K. and M.C. Caldwell. 1989. Pygmy sperm whale, *Kogia breviceps* (de Blainville, 1838): Dwarf sperm whale, *Kogia simus* (Owen, 1866). In: S. H. Ridgway and R. Harrison. Handbook of Marine Mammals. 235-260.
- Carretta, J.V., K.A. Forney, M.S. Lowry, J. Barlow, J. Baker, B. Hanson and M.M. Muto. 2007. U.S. Pacific Marine Mammal Stock Assessments: 2007. U. S. Dept. Commerce. Technical Report NOAA-TM-NMFS-SWFSC-414.
- Carretta, J.V., K.A. Forney, M.S. Lowry, J. Barlow, J. Baker, D. Johnston, B. Hanson, M.M. Muto, D. Lynch and L. Carswell. 2008. U.S. Pacific marine mammal stock assessments: 2008. Dept. of Commerce, NOAA, National Marine Fisheries Service Technical Report NOAA-TM-NMFS-SWFSC-434.
- Chandler, T. and J. Calambokidis. 2003a. 2003 aerial surveys for harbor porpoise and other marine mammals off Oregon, Washington, and British Columbia. Contract Report to Dept. of Commerce, NOAA, Cascadia Research, Olympia, WA.
- Chandler, T. and J. Calambokidis. 2003b. 2002 aerial surveys for harbor porpoise and other marine mammals off Oregon, Washington, and British Columbia. Contract Report to U.S. Dept. of Commerce NOAA, Cascadia Research, Olympia, WA.
- Chivers, S., A.E. Dizon, P.J. Gearin and K.M. Robertson. 2002. Small-scale population structure of eastern North Pacific harbour porpoises (*Phocoena phocoena*) indicated by molecular genetic analyses. Journal of Cetacean Research and Management 4 (2): 111-122.
- Clapham, P.J., C. Good, S.E. Quinn, R.R. Reeves, J.E. Scarff and R.L. Brownell. 2004. Distribution of North Pacific right whales (*Eubalaena japonica*) as shown by 19th and 20th century whaling catch and sighting records. Journal of Cetacean Research and Management 6 (1): 1-6.
- Clapham, P.J., S. Leatherwood, I. Szczepaniak and R.L. Brownell, Jr. 1997. Catches of humpback and other whales from shore stations at Moss Landing and Trinidad, California, 1919-1926. Marine Mammal Science 13 (3): 368-394.
- Condit, R. and B. Le Boeuf. 1984. Feeding habits and feeding grounds of the northern elephant seal. Journal of Mammalogy 65: 281-290.
- Cox, T.M., T.J. Ragen, A.J. Read, E. Vos, R.W. Baird, K. Balcomb, J. Barlow, J. Caldwell, T. Cranford, L. Crum, A. D'amico, G. D'spain, A. Fernández, J. Finneran, R. Gentry, W. Gerth, F. Gulland, J. Hildebrand, D. Houser, T. Huller, P.D. Jepson, D. Ketten, C.D. Macleod, P. Miller, S. Moore, D.C. Mountain, D. Palka, P. Ponganis, S. Rommel, T. Rowles, B. Taylor, P. Tyack, D. Wartzok, R. Gisiner, J. Mead and L. Brenner. 2006. Understanding the impacts of anthropogenic sound on beaked whales. Journal of Cetacean Research and Management 7 (3): 177-187.

- Croll, D.A., C.W. Clark, J. Calambokidis, W.T. Ellison and B.R. Tershy. 2001. Effect of anthropogenic low-frequency noise on the foraging ecology of Balaenoptera whales. *Animal Conservation* 4 (1): 13-27.
- Darling, J.D. 1984. Gray whales off Vancouver Island, British Columbia. In: M.L. Jones, S.L. Swartz and S. Leatherwood. *The Gray Whale, Eschrichtius robustus*. Orlando: Academic Press. 267-287 pp.
- Darling, J.D., J. Calambokidis, K.C. Balcomb, P. Bloedel, K. Flynn, A. Mochizuki, K. Mori, F. Sato, H. Suganuma and M. Yamaguchi. 1996. Movement of a humpback whale (*Megaptera novaeangliae*) from Japan to British Columbia and return. *Marine Mammal Science* 12 (2): 281-287.
- Delong, R.L. and G.A. Antonelis. 1991. Impact of the 1982-1983 El Niño on the northern fur seal population at San Miguel Island, California. In: F. Trillmich and K.A. Ono. *Pinnipeds and El Niño: Responses to Environmental Stress*. Berlin: Springer-Verlag. 75-83 pp.
- Delong, R.L. and B.S. Stewart. 1991. Diving patterns of northern elephant seal bulls. *Marine Mammal Science* 7 (4): 369-384.
- Dohl, T.P. 1983. Cetaceans of central and Northern California, 1980-1983: Status, abundance, and distribution. Contract Report to Pacific OCS, U.S. Dept. of Interior, MMS. 284 pp.
- Donovan, G. 1991. A review of IWC stock boundaries. In: Report of the International Whaling Commission, Special Issue 13: 39-68.
- Doroshenko, N.V. 2000. Soviet whaling for blue, gray, bowhead and right whales in the North Pacific Ocean, 1961-1979. Center for Russian Environmental Policy, Marine Mammal Council, Moscow. 96-103 pp.
- Dorsey, E.M. 1983. Exclusive adjoining ranges of individually identified minke whales (*Balaenoptera acutorostrata*) in Washington State. *Canadian Journal of Zoology* 61: 174-181.
- Dorsey, E.M., S.J. Stern, A.R. Hoesel and J. Jacobsen. 1990. Minke whales (*Balaenoptera acutorostrata*) from the West Coast of North America: individual recognition and small-scale site fidelity. Report of the International Whaling Commission Special Issue 12 357-368.
- Douglas, A.B., J. Calambokidis, S. Raverty, S.J. Jefferies, D.M. Lambourn and S.A. Norman. 2008. Incidence of ship strikes of large whales in Washington State. *Journal of the Marine Biological Association of the United Kingdom* 88 (6): 1121-1132.
- Estes, J.A., R.J. Jameson and E.B. Rhode. 1982. Activity and prey selection in the sea otter: Influence of population status on community structure. *American Naturalist* 120 (2): 242-258.

- Falcone, E.A., J. Calambokidis, G.H. Steiger, M. Malleson and J.K.B. Ford. 2005. Humpback whales in the Puget Sound/Georgia Strait region, In: Puget Sound Georgia Basin Research Conference, Seattle. Puget Sound Action Team.
- Ferrero, R.C. and L.M. Tsunoda. 1989. First record of a bottlenose dolphin (*Tursiops truncatus*) in Washington State. *Marine Mammal Science* 5 (3): 302-305.
- Fiscus, C.H. and H. Kajimura. 1969. Pelagic fur seal investigations, 1966. F. U S Department of the Interior. Washington, DC. 59 pp.
- Fiscus, C.H. and K. Niggol. 1965. Observations of cetaceans off California, Oregon and Washington. U.S. Dept. of Interior, FWS. Special Scientific Report Fisheries 498. 1-27 pp.
- Fitch, J.E. and R.L. Brownell. 1968. Fish otoliths in cetacean stomachs and their importance in interpreting feeding habits. *Journal of the Fisheries Research Board of Canada* 25 (12): 2561-2574.
- Flaherty, C.V. 1983. Observations of gray whales in Washington waters. *Cetus* 5 (1): 16-18.
- Ford, J.K.B., G.M. Ellis and K.C. Balcomb. 2000. Killer Whales: The natural history and genealogy of *Orcinus orca* in British Columbia and Washington. Vancouver: University of British Columbia Press. 104 pp.
- Ford, J.K.B., G.M. Ellis, D.R. Matkin, K.C. Balcomb, D. Briggs and A.B. Morton. 2005a. Killer whale attacks on minke whales: prey capture and antipredator tactics. *Marine Mammal Science* 21 (4): 603-618.
- Ford, J.K.B., G.M. Ellis and P.F. Olesiuk. 2005b. Linking prey and population dynamics: did food limitation cause recent declines of 'resident' killer whales (*Orcinus orca*) in British Columbia? Department of Fisheries and Oceans Canada Research Document 2005/042.
- Forney, K.A. 2007. Preliminary estimates of cetacean abundance along the U.S. West Coast and within four national marine sanctuaries during 2005. U.S. Dept. of Commerce, NOAA Technical Memorandum NMFS-SWFSC-406. 33 pp.
- Forney, K.A., J. Barlow and J.V. Carreta. 1995. The abundance of cetaceans in California waters. Part II: Aerial surveys in winter and spring of 1991 and 1992. *Fishery Bulletin* 93 (1): 15-26.
- Forney, K.A. and P.R. Wade. 2006. Worldwide distribution and abundance of killer whales. In: J.A. Estes, D.P. DeMaster, D.F. Doak, T.M. Williams, and R.L. Brownell, Jr., Whales, Whaling, and Ocean Ecosystems. Berkeley: University of California Press. 145-162 pp.
- Fowler, C.W. 1982. Interactions of northern fur seals and commercial fisheries, In: Transactions of the North American Wildlife Conference, 47: 278-292.
- Frantzis, A. 1998. Does acoustic testing strand whales? *Nature* 392: 29.

- Gearin, P.J., S.R. Melin, R.L. Delong, H. Kajimura and M.A. Johnson. 1994. Harbor porpoise interactions with a chinook salmon set-net fishery in Washington State. Report of the International Whaling Commission 15: 427-438.
- Gilmore, R.M. 1956. Rare right whale visits California. *Pacific Discovery* 9 (4): 20-25.
- Gosho, M.E., D.W. Rice and J.M. Breiwick. 1984. The sperm whale, *Physeter macrocephalus*. *Marine Fisheries Review* 46 (4): 54-64.
- Green, G.A., J.J. Brueggeman, R.A. Grotefendt and C.E. Bowlby. 1995. Offshore distances of gray whales migrating along the Oregon and Washington coasts, 1990. (*Eschrichtius robustus*). *Northwest Science* 69 (3): 223-227.
- Green, G.A., J.J. Brueggeman, R.A. Grotefendt, C.E. Bowlby, M.L. Bonnell and K.C. Balcomb. 1992. Cetacean distribution and abundance off Oregon and Washington, 1989-1990. Final Report to Pacific OCS, Dept. of Interior, MMS. Ebasco Environmental, Seattle, WA. 100 pp.
- Gulland, F., H. Pérez-Cortés, M.J. Urbán, R.L. Rojas-Bracho, G. Ylitalo and J. Weir. 2005. Eastern North Pacific gray whale (*Eschrichtius robustus*) unusual mortality event, 1999–2000: a compilation. U.S. Dept. NOAA Technical Memorandum NMFS-AFSC-150. 44 pp.
- Hauser, D.D.W. 2006. Summer space use of southern resident killer whales (*Orcinus orca*) within Washington and British Columbia inshore waters. MS Thesis, University of Washington. 130 pp.
- Heimlich-Boran, J.R. 1988. Behavioral ecology of killer whales (*Orcinus orca*) in the Pacific Northwest. *Canadian Journal of Zoology* 66: 565-578.
- Heise, K.A. 1997. Diet and feeding behaviour of Pacific white-sided dolphins (*Lagenorhynchus obliquidens*) as revealed through the collection of prey fragments and stomach content analyses. Report to the International Whaling Commission 47: 807-815.
- Henderson, D.A. 1984. 19th century gray whaling - grounds, catches and kills, practices and depletion of the whale population. In: M.L. Jones, S.L. Swartz and S. Leatherwood. *The Gray Whale, Eschrichtius robustus*. New York: Academic Press. 159-186 pp.
- Herzing, D.L. and B.R. Mate. 1984. Gray whale migrations along the Oregon Coast, 1978-1981. In: M.L. Jones, S.L. Swartz and S. Leatherwood. *The Gray Whale*. New York: Academic Press. 289-308 pp.
- Hewitt, R.P. and J.D. Lipsky. 2002. Krill and other plankton. In: W.F. Perrin, B. Wursig, and J. G.M. Thewissen. *Encyclopedia of Marine Mammals*. San Diego: Academic Press. 676-684 pp.
- Heyning, J.E. 2002. Cuvier's beaked whale, *Ziphius cavirostris*. In: W.F. Perrin, B. Wursig and J.G.M. Thewissen. *Encyclopedia of Marine Mammals*. San Diego: Academic Press.

- Heyning, J.E. and M.E. Dahlheim. 1990. Strandings and incidental takes of gray whales. International Whaling Commission Scientific Committee Document SC/A90/G2
- Hoelzel, A.R., E.M. Dorsey and S.J. Stern. 1989. The foraging specializations of individual minke whales. *Animal Behaviour* 38: 786-794.
- Hoelzel, A.R., A. Natoli, M.E. Dahlheim, C. Olavarria, R.W. Baird and N.A. Black. 2002. Low worldwide genetic diversity in the killer whale (*Orcinus orca*): implications for demographic history. *Proceedings of the Royal Society B: biological sciences* 269 (1499): 1467.
- Horwood, J. 2002. Sei whale, *Balaenoptera borealis*. In: W.F. Perrin, B. Wursig and J.G.M. Thewissen. *Encyclopedia of Marine Mammals*. San Diego: Academic Press. 1069-1071 pp.
- Hoyt, E. 1984. Orca the whale called killer. Ontario: Camden House. 292 pp.
- Huber, H.R., S. Jefferies, R. Brown and R.L. DeLong. 1994. Harbor seal stock assessment in Washington and Oregon 1993. Annual report to the U.S. Dept. of Commerce, NOAA, National Marine Fisheries Service, MMPA Assessment Program, Office of Protected Resources.
- Jameson, R.J., K.W. Kenyon, S. Jeffries and G.R. Vanblaricom. 1986. Status of a translocated sea otter population and its habitat in Washington. *The Murrelet* 67: 84-87.
- Jameson, R.J., K.W. Kenyon, A.M. Johnson and H.M. Wight. 1982. History and status of translocated sea otter populations in North America. *Wildlife Society Bulletin* 10: 100-107.
- Jefferies, S.J., P.J. Gearin, H.R. Huber, D.L. Saul and D.A. Pruett. 2000. Atlas of seal and sea lion haulout sites in Washington. Washington Dept. of Fish & Wildlife. Olympia, WA. 157 pp.
- Jefferies, S.J., H. Huber, J. Calambokidis and J. Laake. 2003. Trends and status of harbor seals in Washington State 1978-1999. *Journal of Wildlife Management* 67 (1): 207-218.
- Jefferson, T.A., P.J. Stacey and R.W. Baird. 1991. A review of killer whale interactions with other marine mammals: predation to co-existence. *Mammal review* 21 (4): 151-180.
- Jepson, P.D., M. Arbelo, R. Deaville, I.A.P. Patterson, P. Castro, J.R. Baker, E. Degollada, H.M. Ross, P. Herráez, A.M. Pockness, F. Rodriguez, F.E. Howie, A. Espinosa, R.J. Reid, J.R. Jaber, V. Martin, A.A. Cunningham and A. Fernandez. 2003. Gas-bubble lesions in stranded cetaceans: Was sonar responsible for a spate of whale deaths after an Atlantic military exercise? *Nature* 425 (6958): 575-576.
- Johnson, J.H. and A.A. Wolman. 1984. The humpback whale, *Megaptera novaeangliae*. *Marine Fisheries Review* 46 (4): 30-37.
- Jones, I.M. 2006. A northeast Pacific offshore killer whale (*Orcinus orca*) feeding on a Pacific halibut (*Hippoglossus stenolepis*). *Marine Mammal Science* 22 (1): 198-200.

- Kajimura, H. 1984. Opportunistic feeding of the northern fur seal, *Callorhinus ursinus*, in the eastern North Pacific Ocean and eastern Bering Sea. U.S. Dept. of Commerce, National Marine Fisheries Service. Seattle. 52 pp.
- Kasuya, T. 2002. Giant beaked whales, *Berardius bairdii* and *B. arnuxii*. In: W.F. Perrin, B. Wursig and J.G.M. Thewissen. Encyclopedia of Marine Mammals. San Diego: Academic Press. 519-522 pp.
- Kelly, B.P. 1981. Pelage polymorphism in Pacific harbor seals. Canadian Journal of Zoology 59 (7): 1212-1219.
- Kenney, R.D. 2002. North Atlantic, North Pacific, and Southern right whales. In: W.F. Perrin, B. Wursig and J.G.M. Thewissen. Encyclopedia of Marine Mammals. San Diego: Academic Press. 806-813 pp.
- Kraus, S.D. 1990. Rates and potential causes of mortality in North Atlantic right whales (*Eubalaena glacialis*). Marine Mammal Science 6 (4): 278-291.
- Kruse, S. 1989. The behavior and ecology of Risso's dolphins (*Grampus griseus*) in Monterey Bay, California., In: 8th Biennial Conference on the Biology of Marine Mammals, Pacific Grove, CA. 36 pp.
- Lance, M.M., S.A. Richardson and H.L. Allen. 2004. Washington state recovery plan for the sea otter. WDFW. Olympia, WA. 103 pp.
- Le Boeuf, B.J., D.P. Costa, A.C. Huntley, G.L. Kooyman and R.W. Davis. 1986. Pattern and depth of dives in northern elephant seals, *Mirounga angustirostris*. Journal of Zoology, London 208 1-7.
- Leatherwood, S., R.R. Reeves, W.F. Perrin and W.E. Evans. 1982. Whales, dolphins, and porpoises of the Eastern North Pacific and adjacent waters. A guide to their identification. U S Dept. of Commerce, NOAA. Springfield, VA NOAA Technical Report NMFS Circular 444.
- Leduc, R. 2002. Delphinids, Overview. In: W.F. Perrin, B. Wursig and J.G.M. Thewissen. Encyclopedia of Marine Mammals. San Diego: Academic Press. 310-314 pp.
- Lipsky, J.D. 2002. Right whale dolphins, *Lissodelphis borealis* and *L. peronii*. In: W.F. Perrin, B. Wursig and J.G.M. Thewissen. Encyclopedia of Marine Mammals. San Diego: Academic Press.
- Lowry, M.S., J.V. Carreta and K. Forney. 2005. Pacific harbor seal, *Phoca vitulina richardsi*, census in California during May-June 2004. U.S. Dept. of Commerce, NOAA, Southwest Fisheries Science Center Administrative Report LJ-05-06. 38.

- Macleod, C.D. and A. D'amico. 2006. A review of beaked whale behavior and ecology in relation to assessing and mitigating impacts of anthropogenic noise. *Journal of Cetacean Research and Management* 7 (3): 211-221.
- Masaki, Y. 1977. The separation of the stock units of sei whales in the North Pacific. Report of the International Whaling Commission Special Issue 1: 71-79.
- Mate, B.R., B.A. Lagerquist and J. Calambokidis. 1999. Movements of North Pacific blue whales during the feeding season off Southern California and their southern fall migration. *Marine Mammal Science* 15 (4): 1246-1257.
- McDonald, M. 1994. Vocalization tracking of blue and fin whales in the North Pacific, In: *Journal of the Acoustical Society of America*, Austin, Texas. 96: 3315.
- Mehta, A.V., J.M. Allen, R. Constantine, C. Garrigue, B. Jann, C. Jenner, M.K. Marx, C.O. Matkin, D.K. Mattila, G. Minton, S.A. Mizroch, C. Olavarria, J. Robbins, K.G. Russell, R. E. Seton, G.H. Steiger, G.A. Vikingsson, P.R. Wade, B.H. Witteveen and P.J. Clapham. 2007. Baleen whales are not important prey for killer whales *Orcinus orca* in high-latitude regions. *Marine Ecology Progress Series* 348: 297-307.
- Mesnick, S.L., B.L. Taylor, B. Nachenberg, A. Rosenberg, S. Peterson, J. Hyde and A.E. Dizon. 1999. Genetic relatedness within groups and the definition of sperm whale stock boundaries from the coastal waters off California, Oregon and Washington. M.E. Group. La Jolla U.S. Dept. of Commerce, NOAA, SWFSC Administrative Report LJ-99-12. 10 pp.
- Moore, S.E., K.M. Stafford, M.E. Dahlheim, C.G. Fox, H.W. Braham, J.J. Polovina and D.E. Bain. 1998. Seasonal variation in reception of fin whale calls at five geographic areas in the North Pacific. (*Balaenoptera physalus*). *Marine Mammal Science* 14 (3): 617-627.
- Morton, A.B. 1990. A quantitative comparison of the behavior of resident and transient forms of the killer whale off the central British Columbia coast. Report of the International Whaling Commission Special Issue 12: 245-248.
- Murison, L.D., D.J. Murie, K.R. Morin and J. Da Silva Curiel. 1984. Foraging of the gray whale along the West Coast of Vancouver Island, British Columbia. In: M.L. Jones, S.L. Swartz and S. Leatherwood. *The Gray Whale, Eschrichtius robustus*. Orlando: Academic Press. 451-463 pp.
- Nargorsen, D.W. and G.E. Stewart. 1983. A dwarf sperm whale (*Kogia simus*) from the Pacific Coast of Canada. *Journal of Mammalogy* 64 (3): 505-506.
- Nerini, M. 1984. A review of gray whale feeding ecology. In: M.L. Jones, S.L. Swartz and S. Leatherwood. *The Gray Whale, Eschrichtius robustus*. Orlando: Academic Press. 423-450 pp.
- Norman, S.A., C.E. Bowlby, M.S. Brancato, J. Calambokidis, D. Duffield, P.J. Gearin, T.A. Gornall, M. Goshou, B. Hanson, J. Hodder, S.J. Jefferies, B.A. Lagerquist, D.M. Lambourn,

- B.R. Mate, B. Norberg, R.W. Osborne, J. Rash, S.D. Riemer and J. Scordino. 2004. Cetacean strandings in Oregon and Washington between 1930 and 2002. *Journal of Cetacean Research and Management* 6 (1): 87-99.
- O'corry-Crowe, G.M., K.K. Martien and B.L. Taylor. 2003. The analysis of population genetic structure in Alaskan harbor seals, *Phoca vitulina*, as a framework for the identification of management stocks. U.S. Dept. of Commerce, NOAA, Southwest Fisheries Science Center. La Jolla SWFSC Administrative Report LJ-03-08. 64 pp.
- Oleson, E.M., J. Calambokidis, E.A. Falcone, G.S. Schorr and J. Hildebrand. 2009. Acoustic and visual monitoring of cetaceans along the outer Washington coast. N.P. School. Monterey Report # NPS-OC-09-001. 45 pp.
- Oliver, J.S. and P.N. Slattery. 1985. Destruction and opportunity on the sea floor: effects of gray whale feeding. *Ecology* 66 (6): 1965-1975.
- Olson, P.A. and S.B. Reilly. 2002. Pilot whales, *Globicephala melas* and *G macrorhynchus*. In: W.F. Perrin, B. Wursig and J.G.M. Thewissen. *Encyclopedia of Marine Mammals*. San Diego: Academic Press.
- Osborne, R.W. 1999. A historical ecology of Salish Sea "resident" killer whales (*Orcinus orca*): with implications for management. Ph D Dissertation, University of Victoria. 282 pp.
- Osborne, R.W., J. Calambokidis and E.M. Dorsey. 1988. A Guide to Marine Mammals of Greater Puget Sound. Anacortes, WA: Island Publishers. 191 pp.
- Osmek, S., J. Calambokidis, J. Laake, P. Gearin, R. Delong, J. Scordino, S.J. Jefferies and R. Brown. 1996. Assessment of the status of harbor porpoise (*Phocoena phocoena*) in Oregon and Washington waters. U.S. Dept. of Commerce, NOAA, NMML. Seattle NOAA Technical Memorandum NMFS-AFSC-76. 46 pp.
- Patten, D.R. and W.F. Samaras. 1977. Unseasonable occurrences of gray whales. *Bulletin of the Southern California Academy of Sciences* 76 (3): 205-208.
- Perrin, W.F., B. Wursig and J.G.M. Thewissen. 2002. *Encyclopedia of Marine Mammals*. San Diego: Academic Press.
- Pike, G.C. 1962. Migration and feeding of the gray whale (*Eschrichtius gibbosus*). *Journal of the Fisheries Research Board of Canada* 19 (5): 815-838.
- Pike, G.C. and I.B. Macaskie. 1969. Marine mammals of British Columbia. *Bulletin of the Fisheries Research Board of Canada* 171: 1-54.
- Pitman, R.L. 2002. Mesoplodont whales. In: W.F. Perrin, B. Wursig and J.G.M. Thewissen. *Encyclopedia of Marine Mammals*. San Diego: Academic Press. 7 38-742.

- Pitman, R.L., L.T. Ballance, S.I. Mesnick and S.J. Chivers. 2001. Killer whale predation on sperm whales: observations and implications. *Marine Mammal Science* 17 (3): 494-507.
- Rathbun, G.A., J. Estes and R.L. Brownell. 1989. Reintroduction of sea otters to San Nicolas Island, California, In: Eighth Biennial Conference on the Biology of Marine Mammals, Pacific Grove, CA.
- Reeves, R.R. 1992. Whale responses to anthropogenic sounds: a literature review. New Zealand Dept. of Conservation.
- Reeves, R.R. and S. Leatherwood. 1985. Sightings of right whales (*Eubalaena glacialis*) in the eastern North Pacific, In: International Whaling Commission, SC/37/PS3: 11.
- Reeves, R.R., B.S. Stewart and S. Leatherwood. 1992. The Sierra Club handbook of seals and sirenians. San Francisco: Sierra Club Books. 359 pp.
- Reidman, M.L. and J. Estes. 1990. The sea otter (*Enhydra lutris*): Behavior, ecology, and natural history. U. S. Dept. of Interior. Washington, DC. U.S. Fish and Wildlife Biological Report 90 -41. 1-126 pp.
- Reilly, S.B. and V.G. Thayer. 1990. Blue whale (*Balaenoptera musculus*) distribution in the Eastern Tropical Pacific. *Marine Mammal Science* 6 (4): 265-277.
- Rice, D.W. 1963. Progress report on biological studies on the larger Cetacea in the waters off California. *Norsk Hvalfangst-tidende* 7 181-187.
- Rice, D.W. 1974. Whales and whale research in the eastern North Pacific. In: W.E. Shevill. *The Whale Problem*. Cambridge, MA: Harvard University Press. 170-175 pp.
- Rice, D.W. 1978. The humpback whale in the North Pacific: distribution, exploitation and numbers. U. S. Marine Mammal Commission. Washington DC. 29-44 pp.
- Rice, D.W. and C.H. Fiscus. 1968. Right whales in the southeastern North Pacific. *Norsk Hvalfangst-tidende* 57 (5): 105-107.
- Rice, D.W. and A.A. Wolman. 1971. Life History and Ecology of the Gray Whale (*Eschrichtius robustus*). American Society of Mammalogists. 142 pp.
- Rice, D.W., A.A. Wolman and H.W. Braham. 1984. The gray whale, *Eschrichtius robustus*. *Marine Fisheries Review* 46 (4): 7-14.
- Riedman, M.L. and J.A. Estes. 1990. The sea otter (*Enhydra lutris*): behavior, ecology, and natural history. U S Dept. of the Interior. 126 pp.
- Rivers, J.A. 1997. Blue whale, *Balaenoptera musculus*, vocalizations from the waters off central California. *Marine Mammal Science* 13 (2): 186-195.

- Rosel, P.E., A.E. Dizon and M.G. Haygood. 1995. Variability of the mitochondrial control region in populations of the harbour porpoise, *Phocoena phocoena*, on interoceanic and regional scales. *Canadian Journal of Fisheries and Aquatic Sciences* 52: 1210-1219.
- Rosenbaum, H.C., R.L. Brownell, M.W. Brown, C. Schaeff, V. Portway, B.N. White, S. Malik, L.A. Pastene, N. Patenaude and C.S. Baker. 2000. World-wide genetic differentiation of *Eubalaena*: questioning the number of right whale species. *Molecular Ecology* 9 (11): 1793-1802.
- Ross, H.M. 1984. The smaller cetaceans of the southeast coast of southern Africa. *Annals of the Cape Provincial Museums (Natural History)* 15 (2): 173-410.
- Rowlett, R.A., G.A. Green, C.E. Bowlby and M.A. Smultea. 1994. The first photographic documentation of a northern right whale off Washington State. (*Eubalaena glacialis*). *Northwestern Naturalist* 75 (3): 102-104.
- Rugh, D.J., R.C. Hobbs, J.A. Lerczak and J.M. Breiwick. 2005. Estimates of abundance of the eastern North Pacific stock of gray whales (*Eschrichtius robustus*) 1997-2002. *Journal of Cetacean Research and Management* 7 (1): 1-12.
- Scarff, J.E. 1986. Historic and present distribution of the right whale (*Eubalaena glacialis*) in the eastern North Pacific south of 50°N and east of 180°W, In: R. Brownell, P.B. Best and J.H. Prescott. *Proceedings of the Workshop on the Status of Right Whales*, Reports of the International Whaling Commission: 43-63.
- Scheffer, V.B. and J.W. Slipp. 1944. The harbor seal of Washington state. *American Midland Naturalist* 32 (2): 373-416.
- Scheffer, V.B. and J.W. Slipp. 1948. The whales and dolphins of Washington state. *American Midland Naturalist* 39 (2): 257-337.
- Sinclair, E.H. 1994. Prey of juvenile northern elephant seals (*Mirounga angustirostris*) in the Southern California Bight. *Marine Mammal Science* 10 (2): 230-239.
- Siniff, D.B., T.D. Williams, A.M. Johnson and D.L. Garshelis. 1982. Experiments on the response of sea otters *Enhydra lutris* to oil contamination. *Biological Conservation* 23 (4): 261-272.
- Springer, A.M., J.A. Estes, G.B. Van Vliet, T.M. Williams, D.F. Doak, E.M. Danner, K.A. Forney and B. Pfister. 2003. Sequential megafaunal collapse in the North Pacific Ocean: An ongoing legacy of industrial whaling? *Proceedings of the National Academy of Sciences* 100 (21): 12223-12228.
- Stafford, K.M., S.L. Nieukirk and C.G. Fox. 1999. An acoustic link between blue whales in the eastern tropical Pacific and the northeast Pacific. (*Balaenoptera musculus*). *Marine Mammal Science* 15 (4): 1258-1268.

- Stafford, K.M., S.L. Nieuwirk and C.G. Fox. 2001. Geographic and seasonal variation of blue whale calls in the North Pacific. (*Balaenoptera musculus*). *Journal of Cetacean Research and Management* 3 (1): 65-76.
- Steiger, G.H. and J. Calambokidis. 2000. Reproductive rates of humpback whales off California. (*Megaptera novaeangliae*). *Marine Mammal Science* 16 (1): 220-239.
- Steiger, G.H., J. Calambokidis, J.M. Straley, L.M. Herman, S. Cerchio, D.R. Salden, J. Urban-R, J.K. Jacobsen, O. Von Ziegesar and K.C. Balcomb. 2008. Geographic variation in killer whale attacks on humpback whales in the North Pacific: implications for predation pressure. *Endangered Species Research* 4 (3): 247-256.
- Stevens, T.A., D.A. Duffield, E.D. Asper, K.G. Hewlett, A. Bolz, L.J. Gage and G.D. Bossard. 1989. Preliminary findings of restriction fragment differences in mitochondrial DNA among killer whales (*Orcinus orca*). *Canadian Journal of Zoology* 67 (10): 2592-2595.
- Stewart, B.S. and R.L. Delong. 1990. Sexual differences in migrations and foraging behavior of northern elephant seals. *American Zoologist* 30: 44A.
- Stewart, B.S. and H.R. Huber. 1993. *Mirounga angustirostris*. *Mammalian Species* 449: 1-10.
- Stewart, B.S., P.K. Yochem, H.R. Huber, R.L. Delong, R.J. Jameson, W.J. Sydeman, S.G. Allen and B.J. Le Boeuf. 1994. History and present status of the northern elephant seal population. In: B.J. Le Boeuf and R.M. Laws. *Elephant Seals: Population Ecology, Behavior and Physiology*. Berkeley: University of California Press. 29-48 pp.
- Stroud, R.K., C.H. Fiscus and H. Kajimura. 1981. Food of the Pacific white-sided dolphin, *Lagenorhynchus obliquidens*, Dall's porpoise, *Phocoenoides dalli*, and northern fur seal, *Callorhinus ursinus*, off California and Washington. *Fishery Bulletin* 78: 951-959.
- Sumich, J.L. 1984. Gray whales along the Oregon Coast in summer, 1977-1980. *The Murrelet* 65: 33-40.
- Sumich, J.L. and J.T. Harvey. 1986. Juvenile mortality in gray whales (*Eschrichtius robustus*). *Journal of Mammalogy* 67 (1): 179-182.
- Tempte, J.L. 1994. Photoperiod control of birth timing in the harour seal (*Phoca vitulina*). *Journal of Zoology, London* 233: 369-384.
- Trites, A.W. and C.P. Donnelly. 2003. The decline of Steller sea lions *Eumetopias jubatus* in Alaska: a review of the nutritional stress hypothesis. *Mammal review* 33 (1): 3-28.
- Turnock, B.J. and I. Quinn, T.J. 1991. The effect of responsive movement on abundance estimation using line transect sampling. *Biometrics* 47: 701-715.
- Wade, L.S. and G.L. Friedrichsen. 1979. Recent sightings of the blue whale, *Balaenoptera musculus*, in the northeastern tropical Pacific. *Fishery Bulletin* 76 (4): 915-919.

- Wade, P., M.P. Heide-Jorgensen, K. Shelden, J. Barlow, J.V. Carretta, J. Durban, R. Leduc, L. Munger, S. Rankin, A. Sauter and C. Stinchcomb. 2006. Acoustic detection and satellite-tracking leads to discovery of rare concentration of endangered North Pacific right whales. *Biology Letters* 2: 417-419.
- Waerebeek, K.V. and B. Wursig. 2002. Pacific white-sided dolphin and dusky dolphin. In: W. F. Perrin, B. Wursig and J.G.M. Thewissen. *Encyclopedia of Marine Mammals*. San Diego: Academic Press.
- Walker, W.A., K.R. Goodrich, S. Leatherwood and R.K. Stroud. 1984. Population biology and ecology of the Pacific white-sided dolphin, *Lagenorhynchus obliquidens*, in the northeastern Pacific. Part II: Biology and geographical variation. U.S. Dept. of Commerce, SWFSC Administrative Report LJ-84-34C. 43 pp.
- Walker, W.A., M.B. Hanson, R.W. Baird and T.J. Guenther. 1998. Food habits of the harbor porpoise, *Phocoena phocoena*, and Dall's porpoise, *Phocoenoides dalli*, in the inland waters of British Columbia and Washington. U.S. Dept. of Commerce, National Marine Fisheries Service. AFSC Processed Report 98-10. 63-75.
- Walker, W.A. and L.L. Jones. 1993. Food habits of northern right whale dolphin, Pacific white-sided dolphin, and northern fur seal caught in the high seas driftnet fisheries of the North Pacific Ocean, 1990. *International North Pacific Fisheries Commission Bulletin* 53 (II): 285-295 pp.
- Walker, W.A., S. Leatherwood, K.R. Goodrich, W.F. Perrin and R.K. Stroud. 1986. Geographical variation and biology of the Pacific white-sided dolphin, *Lagenorhynchus obliquidens*, in the northeastern Pacific. In: M.M. Bryden and R.J. Harrison. *Research on Dolphins*. Oxford: Oxford University Press. 441-465 pp.
- Weitkamp, L.A., R.C. Wissmar, C.A. Simenstad, K.L. Fresh and J.G. Odell. 1992. Gray whale foraging on ghost shrimp (*Callinassa californiensis*) in littoral sand flats of Puget Sound, USA. *Canadian Journal of Zoology* 70 (11): 2275-2280.
- Weller, D.W. 2002. Predation on marine mammals. In: W.F. Perrin, B. Wursig and J.G.M. Thewissen. *Encyclopedia of Marine Mammals*. San Diego: Academic Press. 985-994 pp.
- Weller, D.W., G.A. Tsidulko, Y.V. Ivashchenko, A.M. Burdin and R.L. Brownell, Jr. 2006. A re-evaluation of the influence of 2001 seismic surveys on western gray whales off Sakhalin Island, Russia, In: *International Whaling Commission, Paper SC/58/E5*: 9.
- Wells, R.S. and M.D. Scott. 2002. Bottlenose dolphins, *Tursiops truncatus* and *T. aduncus*. In: W.F. Perrin, B. Wursig and J.G.M. Thewissen. *Encyclopedia of Marine Mammals*. San Diego: Academic Press.
- Westlake, R.L. and G.M. O'corry-Crowe. 2002. Macrogeographic structure and patterns of genetic diversity in harbor seals (*Phoca vitulina*) from Alaska to Japan. *Journal of Mammalogy* 83 (4): 1111-1126.

- Whitehead, H. 2002. Sperm whale, *Physeter macrocephalus*. In: W.F. Perrin, B. Wursig and J.G.M. Thewissen. Encyclopedia of Marine Mammals. Burlington, MA: Academic Press. 1165-1172 pp.
- Willis, P.M., B.J. Crespi, L. M. Dill, R.W. Baird and M.B. Hanson. 2004. Natural hybridization between Dall's porpoises (*Phocoenoides dalli*) and harbour porpoises (*Phocoena phocoena*). Canadian Journal of Zoology 82 (5): 828.
- York, A. E. and J.R. Hartley. 1981. Pup production following harvest of female northern fur seals. Canadian Journal of Fisheries and Aquatic Sciences 38: 84-90.

11. ECOSYSTEM INTERRELATIONSHIPS

11.1 COMPARISON OF TROPHIC-LEVEL PRODUCTIVITY AMONG AREAS

The Northern Study Area is an Eastern Boundary Current (EBC) region of the eastern Pacific Ocean. The geomorphological features that define the Northern Study Area include a narrow continental shelf, an outer shelf cut by numerous deep sea canyons, and proximity to an active tectonic margin (Juan de Fuca Plate) with a subduction zone relatively near shore, and a long (>3000 km) coastline interrupted by a handful of large coastal estuaries. Carr and Kearns (2003) compared the California, Peru-Humbolt, Canary, and Benguela (EBC) systems. They report that at a given nutrient concentration, the biomass sustained is twice as large in the Atlantic (Canary and Benguela) EBCs as in the Pacific (California and Peru-Humbolt) EBCs, most likely due to availability of iron, water mass retention, and planktonic community structure.

The California, Peru-Humbolt, Canary, and Benguela EBC systems are each wind-driven upwelling systems with warm-season stable high pressure systems over their respective subtropical gyres. Wind-driven (Ekman) forcing leads to upwelling, and the thermocline in each of these systems shoals to within the photic zone near the coast. When upwelled water originates within the deeper, nutrient-rich layers below the pycnocline, these four EBC systems had a potential productivity of 1 Gt C /yr Carr (2002), 2% of the total production (40 Gt C/yr), while the four areas combined cover only 0.3% of the total ocean surface area. Carr and Kearns (2003) report the potential productivity maxima as $\sim 3 \text{ g C m}^{-2} \text{ day}^{-1}$.

Kearns and Carr (2003) developed a seasonal climatology of hydrographic parameters and nutrients in these four systems. A combination of hydrography and satellite-derived chlorophyll, sea surface temperature (SST), and photosynthetically available radiation (PAR) were used in the analysis. Carr and Kearns (2003) show seasonal mean chlorophyll and wind vector for the period of 1998-2000 (Figure 1 in the manuscript) and seasonal means of offshore transport, SST anomaly, PAR, chlorophyll, primary production, upwelling density surface, vertical excursion of the upwelling density surface (ΔZ), temperature, salinity, oxygen (O_2) concentration at the source water and phosphate (PO_4) compared with shelf width (Figure 2 in the manuscript). They conclude that within each EBC region, large-scale circulation patterns primarily determine productivity (55%), while local forcing has less influence (18%), with the interaction of the large scale and local scale accounting for moderate variability (27%). Within each region, meridional and seasonal patterns of potential productivity and biomass were influenced primarily by large-scale circulation (41% of regions), large-scale and local forcing (32% of regions) and local forcing alone (23% of regions). Within the regions where large-scale circulation or large-scale and local forcing influence was high, so was the maximum biomass and primary production observed.

Examining the Northern Study Area more closely, as indicated in the [chapter on physical oceanography](#), the relatively narrow continental shelf brings Pacific basin populations and physical attributes close to the coastline, the prevailing northern winds creates favorable conditions for upwelling, and the temperate latitude produces seasonal overturn of the water column and increased productivity over that of tropical regions (Garrison 1999). Cross-shelf

transport of river input is more effective along an eastern ocean boundary because wind stress and eastern boundary currents move river plumes away from the coast during the more productive times of year (Hickey et al. 2010). All these conditions favor strong primary production, which echoes up the food chain to produce abundant populations of fish, invertebrates, birds and marine mammals within the Northern Study Area.

11.2 COMMUNITY ECOLOGY

11.2.1 Ecosystem Food Chains and Energy Transfer

The pelagic marine food chain in the Northern Study Area is dominated by a tightly linked phytoplankton-zooplankton trophic interaction in the water column, feeding small fishes and supporting substantial resident and migratory fish, marine mammal and seabird populations. The very narrow nearshore areas where the bottom is within the photic zone support a healthy food chain of macrophytes and benthic microalgae. The benthic community is largely detrital based, with a wide variety of polychaetes, benthic crustaceans and mollusks supporting larger macrofauna including demersal fish. The pelagic and benthic food chains are tightly coupled in the Northern Study Area, with a rain of zooplankton fecal pellets and occasional large dead animals providing nutrients and carbon to the benthos on the continental shelf and seaward (Lorenzen and Welschmeyer 1983). Closer to shore, the pelagic and benthic communities rely heavily on nutrient and carbon inputs from land, with most coastal embayments dominated by detrital carbon inputs (Simenstad and Wissmar 1985). In a reversal of this trend, so-called “marine derived carbon” is returned to the land in the form of salmonid carcasses, abandoned far upstream in the watersheds surrounding the Northern Study Area. These carcasses bring nutrients to the upper and mid reaches of salmon-bearing rivers contributing sufficient nitrogen to impoverished terrestrial food chains in some watersheds to support increased populations of higher predators (Edmonds and Mikkelsen 2006).

11.2.2 Ratios of Production at Different Trophic Levels

Although there have been few direct measures of the efficiency of the food web in the pelagic portion of the food chain (Landry et al. 1989), it is presumed that the trophic efficiency follows that of a classic temperate system with a 10 percent energy transfer from primary to secondary producers, as well as from secondary consumers to predators. Coastal primary production levels that range from 0.5 to 3 g C/m²/d (Perry et al. 1989) will support zooplankton populations, on average, of 50 to 300 mg C/m²/d.

11.3 POPULATION BIOLOGY (ISLAND BIOGEOGRAPHY THEORY)

Populations and communities of marine organisms inhabit geographic territories that provide the best attributes that support their needs for food, shelter, and proximity to their own species for mating. As climate shifts or food sources become scarce, populations and communities shift in order to maximize the desirable attributes while minimizing energy expenditure through swimming or other locomotion (Harvey et al. 2006). For marine populations that live in proximity to solid structures like underwater reefs or seamounts, the presence of solid features facilitate the migration from one area to another by providing stop-over areas rich in food (Cohen and Carlton 1998; Johansson et al. 2008). At the same time, solid structures that attract

fish (so called FADs, or Fish Aggregation Devices) allow for increased predation, as larger fish, birds and marine mammals expend less energy chasing individual small fish (Dempster 2006). Additionally, studies of localized areas within the Northern Study Area indicate that structures on the surface or at depth can assist populations in expanding their geographic range (Carr 2002). Within the Northern Study Area, invasions by nonnative species have become widespread in the bays and navigable river mouths, including the Columbia River. The major pathway for these invasions is the transport of ships' ballast water (Ruiz et al. 1997). Planktonic larvae of many pelagic and benthic species are carried in ballast water and released in other ports and harbors; every planktonic invasive species found in Puget Sound and coastal estuaries in Oregon was first found in San Francisco Bay, indicating that the coastal shipping trade is a major source of invaders (Bollens et al. 2002).

Although there are no studies of changes in population biology for marine assemblages on the scale of the Northern Study Area, the CalCOFI program monitors the California Current System for multiple trophic levels, with a particular emphasis on the southern portion of the system. CalCOFI monitoring of stations off Newport, Oregon (within the Northern Study Area) and Monterey Bay (south of the Northern Study Area) indicate that the population biology of the plankton and higher levels of the food web vary strongly with large-scale events such as ENSO (Peterson et al. 2006) and the Pacific Decadal Oscillation (DiLorenzo et al. 2008). In addition to varying the population structure, these events can also actively transport organisms between isolated locations of suitable habitat. The European green crab (*Carcinus maenus*) rapidly moved up the coastline from southern Oregon north to Vancouver Island, following a slow northern march from San Francisco Bay during the early 1990s (Jamieson et al. 1998). The rapid movement of the invader coincided with the strong ENSO of 1997-1998, indicating that strong coastal currents during that particular ENSO were responsible for the northward transport of the larvae (Yamada et al. 2005).

11.4 SUMMARY AND DATA GAPS

There are few routine assessments of population or community structure in the Northern Study Area, with the exception of certain fish assemblages of commercial or recreational importance, marine mammal populations, and seabirds. Endangered and threatened species (such as Pacific salmon and green sturgeon) are more routinely assessed than other organisms. Lower trophic levels such as plankton, pelagic invertebrates and benthic invertebrates are not routinely monitored and little data for these populations and communities have been collected in the last three decades. Little is known about benthic community structure except in isolated portions of the coastline and for a few specialized habitats such as deep-sea coral or sponge beds.

A thorough baseline assessment of the pelagic and benthic community structure of the Northern Study Area is needed to establish a benchmark against which future changes due to natural causes or human activities can be measured. Periodic monitoring of the degree of invasion of pelagic and coastal populations is also needed to determine how biogeographic forces and human activities are changing the assemblages.

11.5 LIST OF LITERATURE CITED—ECOSYSTEM RELATIONSHIPS

- Barber, R.T., M.P. Sanderson, S.T. Lindley, F. Chai, J. Newton, C.C. Trees, D.G. Foley and F.P. Chavez. 1996. Primary productivity and its regulation in the equatorial Pacific during and following the 1991–1992 El Niño. *Deep Sea Research* 43(4-6):933-969.
- Bollens, S.M., J.R. Cordell, S. Avent, and R. Hooff. 2002. Zooplankton invasions: a brief review, plus two case studies from the northeast Pacific Ocean. *Hydrobiologica* 480(1-3):1573-5117.
- Carr, M.E. 2002. Estimation of potential productivity in Eastern Boundary currents using remote sensing. *Deep-Sea Research Part II-Topical Studies in Oceanography* 49(1-3):59-80.
- Carr, M.E. and E.J. Kearns. 2003. Production regimes in four Eastern Boundary Current systems. *Deep Sea Resarch II* 50:3199-3221.
- Cohen, A.N. and J.T. Carlton. 1998. Accelerating invasion rate in a highly invaded estuary. *Science* 279:555.
- Dempster, T. 2006. Temporal variability of pelagic fish assemblages around fish aggregation devices: Biological and physical influences. *J. Fish Biology* 66(5):1237-1260.
- Dilorenzo, E., N. Schneider, K.M. Cobb, P.J.S. Franks, K. Chhak, A.J. Miller, J.C. McWilliams, S.J. Bograd, H. Arango, E. Curchitser, T.M. Powell, and P. Riviere. 2008. North Pacific Gyre Oscillation links ocean climate and ecosystem change. *Geophysical Research Letters*, 35(L08607):1-6.
- Edmonds, R.L. and K. Mikkelsen. 2006. Influence of salmon carcass placement in Red Alder Riparian areas on stream chemistry in lowland western Washington. *N. Amer. J. Fish. Mgmt.* 26(3):551-558.
- Garrison, T. 1999. *Oceanography: An invitation to marine science*. Belmont, CA: Wadsworth.
- Jamieson, G.S., E.D. Grosholz, D.A. Armstrong, and R.W. Elnor. 1998. Potential ecological implications from the introduction of the European green crab, *Carcinus maenas* (Linnaeus), to British Columbia, Canada, and Washington, USA. *J. Natural History* 32(10-11):1587-1598.
- Kearns, E.J. and M.-E. Carr. 2003. Seasonal climatologies of nutrients and hydrographic properties on quasineutral surfaces of four coastal upwelling systems. *Deep-Sea Research II*, 50: 3171-3197, doi:10.1016/j.dsr2.2003.07.014.
- Landry, M.R., J.R. Postel, W.K. Peterson and J. Newman. 1989. Broad scale distributional patterns of hydrographic variables on the Washington/Oregon Shelf. In: M.R. and B.M.H. Landry. *Coastal Oceanography of Washington and Oregon*. Amsterdam: Elsevier. Pp 1-40.

- Lorenzen, C.J. and N.A. Welschmeyer. 1983. The in situ sinking rates of herbivore fecal pellets. *J. Plankton Res.* 5(6):929-933.
- Harvey, C.J., N. Tolimieri and P.S. Levin. 2006. Changes in body size, abundance, and energy allocation in Rockfish assemblages of the Northeast Pacific. *Ecological Applications* 16(4):1502-1515.
- Hickey, B.M., R.M. Kudela, J.D. Nash, K.W. Bruland, W.T. Peterson, P. MacCready, E.J. Lessard, D.A. Jay, N.S. Banas, A.M. Baptista, E.P. Dever, P.M. Kosro, L.K. Kilcher, A.R. Horner-Devine, E.D. Zaron, R.M. McCabe, J.O. Peterson, P.M. Orton, J. Pam and M.C. Lohan. 2010. River Influences of Shelf Ecosystems: Introduction and Synthesis. *J. Geophys. Res.*, 115, C00B17, doi:10.1029/2009JC005452.
- Johansson, M.L., M.A. Banks, K.D. Glunt and H.M. Hassel-Finnegan. 2008. Influence of habitat discontinuity, geographical distance, and oceanography on fine-scale population genetic structure of Copper Rockfish (*Sebastes caurinus*). *Molecular Ecology* 17(13):3051-3061.
- Perry, M.J., J.P. Bolger and D.C. English. 1989. Primary Production in Washington Coastal Waters. Chapter 3 in *Coastal Oceanography of Washington and Oregon* by Landry, M.R. and B.M. Hickey (eds).
- Peterson, B., R. Emmett, R. Goericke, E. Venrick, A. Mantyla, S.J. Bograd, F.B. Schwing, R. Hewitt, N. Lo, W. Watson, J. Barlow, M. Lowry, S. Ralston, K. A. Forney, B.E. Lavaniegos, W.J. Sydeman, D. Hyrenbach, R.W. Bradley, P. Warzybok, F. Chavez, K. Hunter, S. Benson, M. Weise, J. Harvey, G. Gaxiola-castro and R. Durazo. 2006. The state of the California current, 2005–2006: Warm in the North, Cool in the South. *State of the California Current. CalCOFI Rep.* 47:30-74.
- Ruiz, G.M., J.T. Carlton, E.D. Grosholz and A.H. Hines. 1997. Global invasions of marine and estuarine habitats by non-indigenous species: Mechanisms, extent, and consequences. *Amer. Zool.* 37(6):621-632.
- Simenstad, C.A. and R.C. Wissmar. 1985. ^{13}C evidence of the origins and fates of organic carbon in estuarine and nearshore food webs. *Mar. Ecol. Prog. Ser.* 22:141-152.
- Yamada, S.B., B.R. Dumbauld, A. Kalin, C.E. Hunt, R. Figlar-Barnes and A. Randall. 2005. Growth and persistence of a recent invader *Carcinus maenas* in estuaries of the northeastern Pacific. *Biological Invasions.* Pp 1464-1573.

12. AREAS OF SPECIAL CONCERN

There are estimated to be over one hundred areas of special concern in the Northern Study Area, under protection of federal, state, local governments, as well as preserves set aside by private and non-governmental organizations (Spalding et al. 2007). Documenting the location and protection afforded many of these areas is challenging, particularly those under local, state and NGO protection. Federal areas include National Marine Sanctuaries, National Parks, National Wildlife Refuges, National Estuarine Research Reserves, and Estuaries of National Significance, as well as sites set aside for archeological and cultural preservation. The three states of the Northern Study Area (Washington, Oregon and California) are in various stages of designating, reviewing, and defining marine reserves and similar areas of special concern.

12.1 MARINE SANCTUARIES

The National Oceanic and Atmospheric Agency (NOAA) administers the National Marine Sanctuary Program. The Sanctuary Program’s mission is to “serve as the trustee for the nation’s system of Marine Protected Areas, to conserve, protect, and enhance their biodiversity, ecological integrity and cultural legacy” (NOAA Sanctuary Program 2009). While each sanctuary has its own unique set of regulations as detailed in 15 CFR Part 922, there are certain regulated activities that apply to all sanctuaries. These are:

- Discharging material or other matter into the sanctuary;
- Disturbance of, construction on, or alteration of the seabed;
- Disturbance of cultural resources; and
- Exploring for, developing, or producing oil, gas, or minerals (with a grandfather clause for preexisting operations).

Since passage of the National Marine Sanctuary Act in 1972, 13 sanctuaries and one national monument have been designated in U.S. waters. Three National Marine Sanctuaries are situated in the Northern Study Area: Cordell Bank, Gulf of the Farallones, and Monterey Bay. Olympic Coast National Marine Sanctuary is located just north of the study area and because of its close proximity, will be considered here along with the other three.

The Olympic Coast National Marine Sanctuary encompasses 3,310 square miles of marine waters off the coast of Washington. The Sanctuary extends from Cape Flattery south to the mouth of the Copalis River and 25 to 50 miles seaward ([Figure 12.1](#)). The sanctuary abuts Olympic National Park at the coastline and protects Swiftsure Bank, Nitnat Canyon, and Quinault Canyon offshore. The Makah, Quileute, Hoh, and Quinault tribes maintain their rights to fish and collect marine resources in the sanctuary and participate on the Sanctuary Advisory Council. There are more than 180 documented shipwrecks within the sanctuary waters (Olympic Coast National Marine Sanctuary 2009).



Figure 12.1. Map showing the Olympic Coast National Marine Sanctuary.

Olympic Coast National Marine Sanctuary,
<http://olympiccoast.noaa.gov/visitor/vismap/welcome.html#>.

Cordell Bank National Marine Sanctuary encompasses 529 square miles of marine waters off the California Coast, with Point Reyes the closest point of land (Figure 12.2). The sanctuary protects a 4.5 by 9.5-mile granitic bank located 43 nautical miles NW from the Golden Gate Bridge and 18 nautical miles west of the Point Reyes Lighthouse. The California current drives

upwelling on the bank and surrounding waters, which supports a rich assemblage of marine mammals, birds, fish, and invertebrates (Cordell Bank National Marine Sanctuary 2009).

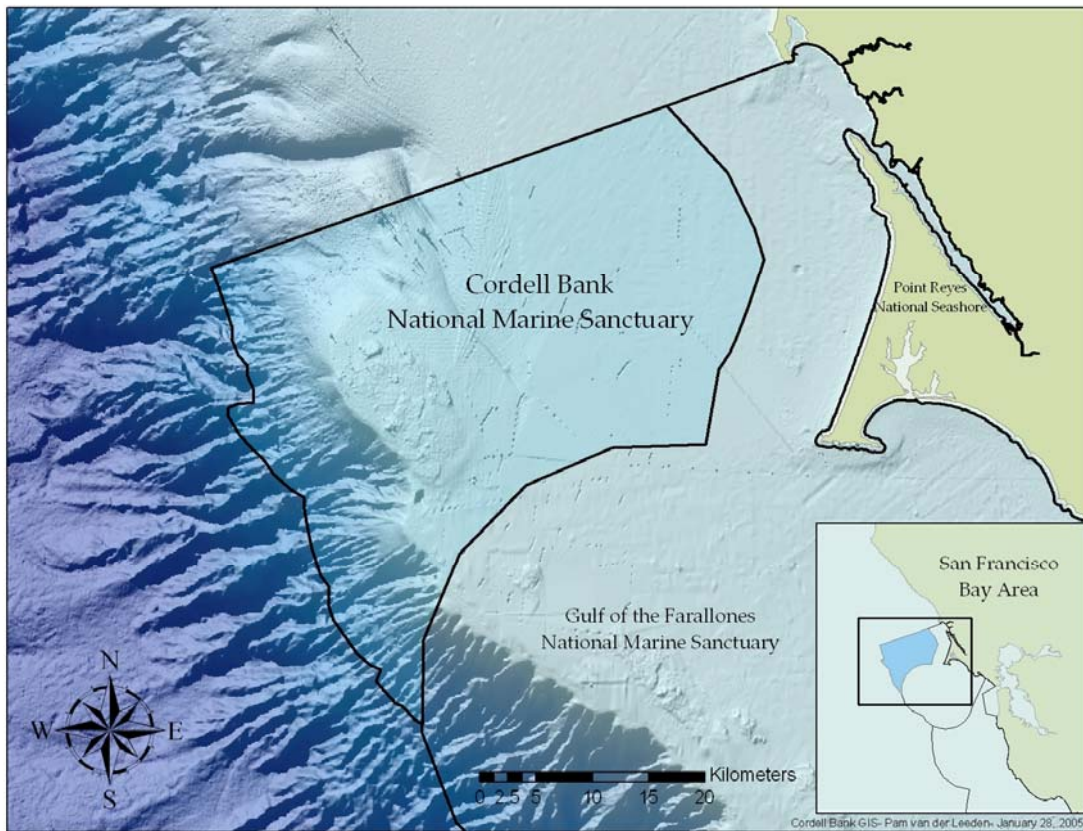

Figure 12.2. Map of Cordell Bank National Marine Sanctuary.

Cordell Bank National Marine Sanctuary, http://cordellbank.noaa.gov/images/sanctuary/cordell_bank.jpg.

Directly south and contiguous with Cordell Bank National Marine Sanctuary, Gulf of the Farallones National Marine Sanctuary encompasses 948 square miles of marine waters west of San Francisco, including offshore regions of the Gulf of the Farallones and inshore waters of Bodega Bay, Tomales Bay, Estero de San Antonio, Estero Americano, and Bollinas Lagoon (Figure 12.3). Twenty percent of California’s harbor seals breed in the Gulf of the Farallones Sanctuary. Seal and sea lion breeding activities attract one of the world’s largest concentrations of white sharks. More than 400,000 seabirds breed in the sanctuary each year, the largest breeding concentration of seabirds in the contiguous U.S. (Gulf of Farallones National Marine Sanctuary 2009).

Monterey Bay National Marine Sanctuary is contiguous with Gulf of the Farallones and stretches south along 276 miles of shoreline from Marin to Cambria, encompassing 5,322 square miles. The sanctuary extends an average of 30 miles offshore, protecting the deep waters of the

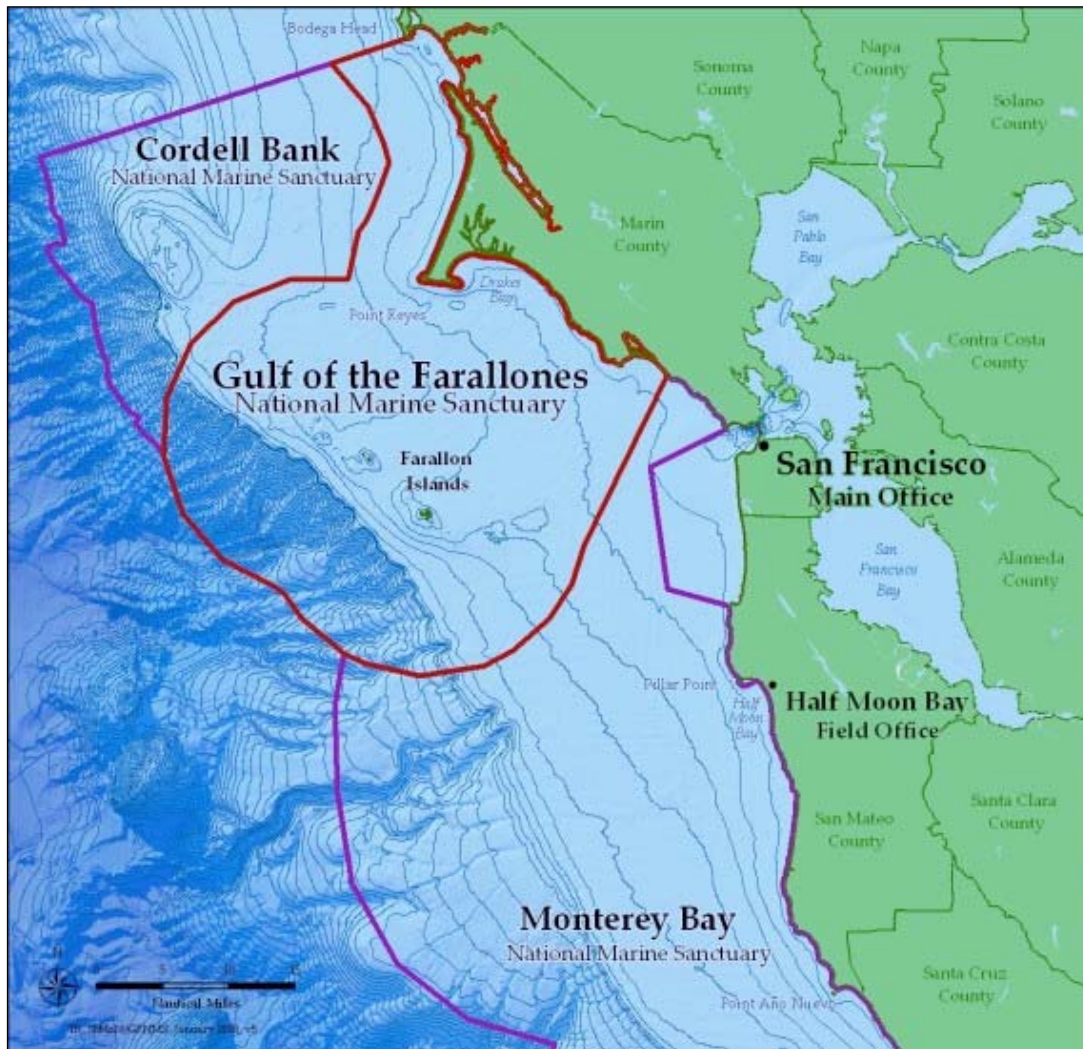

Figure 12.3. Map of Gulf of the Farallones National Marine Sanctuary and adjacent sanctuaries.

Tim Reed, SIMoN/GFNMS, <http://www.sanctuariesimon.org/farallones/index.php>.

Monterey Bay Submarine Canyon as well as the surrounding continental shelf ([Figure 12.4](#)). Monterey Bay is the largest of the National Marine Sanctuaries. With quick access to Monterey Bay Submarine Canyon from the port of Monterey, the sanctuary is a focal point for deep ocean research (Monterey Bay National Marine Sanctuary 2009).

Then NOAA National Marine Sanctuary Program also maintains two incident response databases on secure internet: Sanctuaries Hazardous Incident Logistics Database System (SHIELDS) and Resources and UnderSea Threats (RUST) databases

(<http://sanctuaries.noaa.gov/protect/incident/welcome.html>). The SHIELDS database contains information for resource managers to use during a response, including NOAA databases, geospatial data, maps, charts, images, regulations, policies and RUST. The RUST database includes information on post World War II vessels that are aging and corroding, potentially leading to spill, such as the *SS Jacob Luckenbach*. During the period when oil data is available (August 1990-December 2003), an estimated 51,000 birds and eight Sea Otters are estimated to have been killed (Luckenbach Trustee Council, 2006).

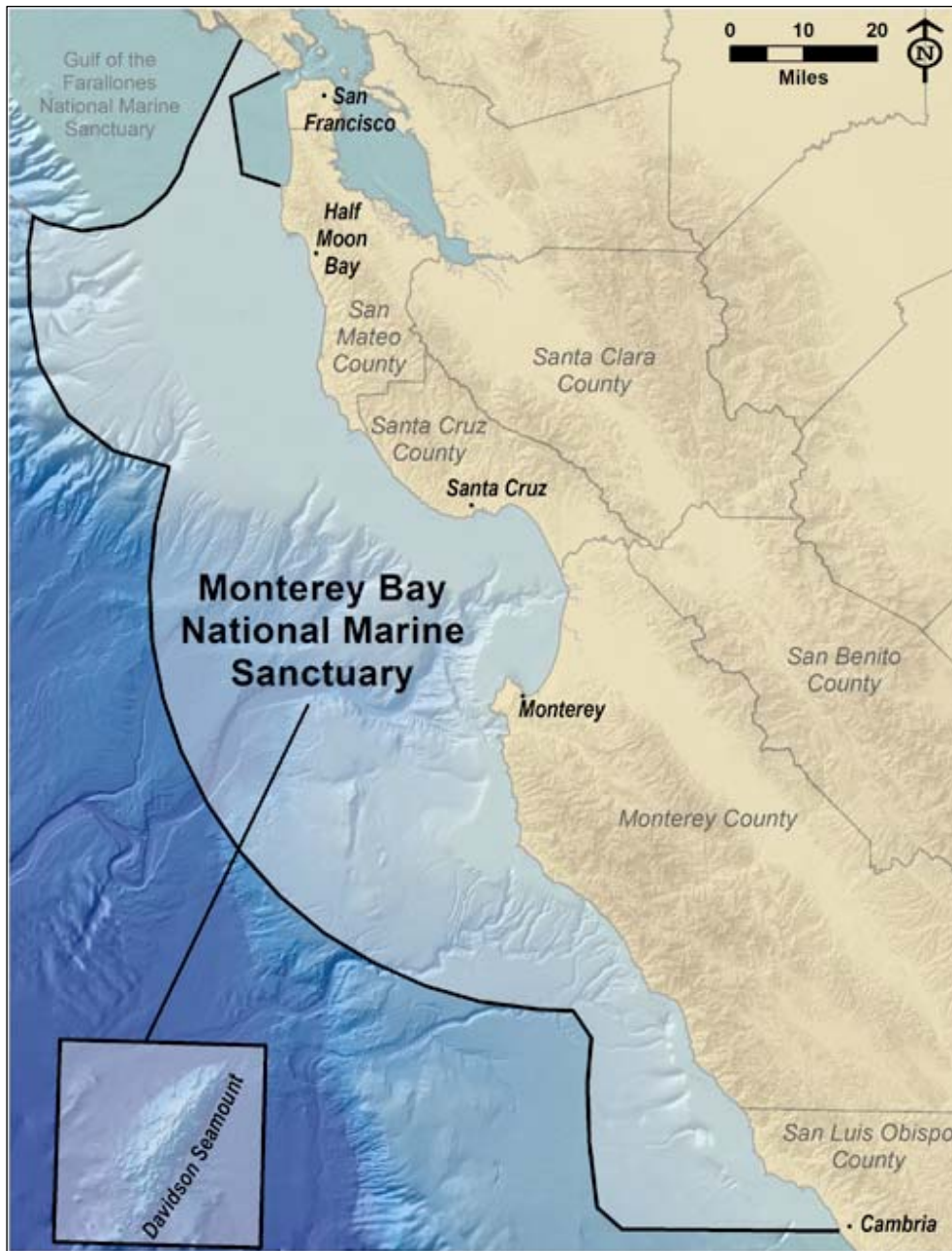

Figure 12.4. Map of Gulf of Monterey Bay National Marine Sanctuary.
 Monterey Bay National Marine Sanctuary, <http://montereybay.noaa.gov/intro/maps.html>.

12.2 NATIONAL PARK SYSTEM

The National Park Service, within the Department of the Interior, administers the U.S. national park system, a network of nearly 400 natural, cultural, and recreation sites across the nation. The Parks Service’s mission is to preserve “unimpaired the natural and cultural resources and values of the national park system for the enjoyment, education, and inspiration of this and future generations” (USDO, National Park Service 2009). There are nine coastal national park system units in the Northern Study Area, seven of which are closely clustered around San Francisco Bay ([Table 12.1](#)). Olympic National Park in Washington State, with its 78 miles of wilderness coastline, is located just north of the Northern Study Area.

Table 12.1.

National Park System Units In the Northern Study Area

State	Park Unit
Oregon	Lewis and Clark National Historic Park
California	Redwood National Park
California	Point Reyes National Seashore
California	Muir Woods National Monument
California	Golden Gate Recreation Area
California	Alcatraz Island
California	Fort Point National Historic Site
California	Presidio of San Francisco
California	San Francisco Maritime National Historic Park

12.3 NATIONAL WILDLIFE REFUGES

The U.S. Fish and Wildlife Service manages the National Wildlife Refuge System for the “conservation, management, and where appropriate, restoration of fish, wildlife and plant resources and their habitat” (USDO, National Wildlife Refuge System 2009). The System consists of 150 million acres, 550 national wildlife refuges and other Refuge System units, and 37 wetland management districts. While conservation of the species and habitats within the refuge system is the primary task of the Refuge System, six other wildlife dependant uses are encouraged where appropriate:

- Hunting
- Fishing
- Birding
- Photography

- Environmental Education
- Interpretation
-

In general, uses of National Wildlife Refuges must be compatible with “the major purposes for which such lands were established” (16USC668dd).

There are 15 National Wildlife Refuge System units that encompass coastal features and estuaries in the Northern Study Area ([Table 12.2](#)).

Table 12.2.

National Wildlife Refuge System Units In the Northern Study Area

State	Refuge Unit
Washington	Grays Harbor NWR
Washington	Willapa NWR
Washington/Oregon	Lewis and Clark NWR
Oregon	Cape Meares NWR
Oregon	Three Arch Rocks NWR
Oregon	Nestucca Bay NWR
Oregon	Siletz Bay NWR
Oregon	Bandon Marsh NWR
Oregon	Oregon Island NWR*
California	Castle Rock NWR
California	Humboldt Bay NWR
California	San Pablo Bay NWR
California	Marin Island NWR
California	Farallon NWR
California	Don Edwards NWR
*Oregon Islands NWR includes over 1,400 coastal islands, rocks and reefs along Oregon’s 320-mile coast from Tillamook head to the California border.	

The U.S. Fish and Wildlife Service maintains a database with GIS mapping information for the National Wildlife Refuge System that can be accessed at: <http://www.fws.gov/realty/carto-resources.htm>.

12.4 NATIONAL ESTUARINE RESEARCH RESERVES

The National Estuarine Research Reserve (NERR) System is administered and funded by the National Oceanic and Atmospheric Administration and managed on a day-to-day basis by participating coastal states. There are 27 NERRs nationwide encompassing more than a million square miles of estuarine land and water. Research Reserves are established in areas representative of various regions and estuarine types and provide opportunities for long-term

research, education, and interpretation. Multiple uses within the reserves are allowed to the degree compatible with a Reserve's overall purpose as provided in its management plan.

There are two NERR's within the Northern Study Area: South Slough, Oregon and San Francisco Bay, California.

South Slough NERR is located five miles south of Charleston, Oregon on the South Slough of the Coos Bay Estuary. The Reserve includes 4,779 acres of upland forests, freshwater wetlands, mudflats, eelgrass meadows, and open waters.

San Francisco Bay NERR is comprised of 3,710 acres divided between two components: Rush Ranch (east of San Rafael), and China Camp State Park (south of Suisun City). The Reserve was designated in 2003 to support tidal marsh restoration in San Francisco Bay through research, monitoring, and education.

12.5 NATIONAL ESTUARY PROGRAM

The Environmental Protection Agency's National Estuarine Program (NEP) was established in 1987 to improve water quality in 28 Estuaries of National Significance. Established by amendment to the Clean Water Act, the NEP directs EPA to develop plans for designated estuaries to maintain water quality through point and nonpoint source pollution controls; protect public water supplies; protect indigenous populations of shellfish, fish, and wildlife; and allow recreational activities. There are three National Estuarine Program Study Areas within the Northern Study Area: Lower Columbia River Estuary in Washington, Tillamook Estuaries in Oregon, and San Francisco Estuary in California.

12.6 ARCHAEOLOGICAL SITES

For at least 10,000 years the Pacific Coast and coastal estuaries have provided food, trade goods, and transportation routes for coastal peoples (Carlson 1990). Their descendents—the Makah, Quilleute, Hoh, Quinault, Coquille, Siletz, Coos, Lower Umpqua, Siuslaw, Tolowa, Yurok, Wiyot, Mattole, Sinkiyone, Yuki, Pomo, Miwok, and Costanoan—still inhabit the area today. Beginning 400 years ago, the same resources that first attracted Native Americans fueled euro American exploration, settlement, and commerce. With such a long period of habitation and associated exploitation of natural resources, the Northern Study Area contains many thousands of documented prehistoric and submerged maritime cultural sites.

Archaeological sites are protected under the National Historic Preservation Act of 1966 (NHPA). The NHPA created the National Register of Historic Places and tasked the National Park Service with its management. Section 106 of the NHPA requires all Federal agencies to consider the effects of their actions on historic properties listed on or eligible for the National Register. At the state level, State Historic Preservation Officers (SHPOs) work with the public, tribes, Federal agencies, and the Advisory Council on Historic Preservation to ensure compliance with Section 106.

Each of three SHPOs in the Northern Study Area maintain databases of known cultural or archaeological sites:

- Washington State Department of Archaeology and Historic Preservation (DAHP)
- Oregon State Historic Preservation Office (SHPO)
- The California Office of Historic Preservation (OHP)

To prevent looting or desecration, the locations of documented prehistoric archaeological sites are not publicly available. For a site-specific inventory of known sites, it is necessary to contact the SHPO. The location of historic sites listed on the National Register, such as lighthouses or historic waterfront buildings, can be obtained online from the National Register of Historic Places (<http://nrhp.nps.gov>).

There are thousands of known shipwreck sites in the Northern Study Area. The stretch of coastline from Tillamook Bay, Oregon to Vancouver Island is known as the “Graveyard of the Pacific,” with more than 2,000 shipwrecks since 1880 (Wilma 2006). The California Shipwrecks database (<http://shipwrecks.slc.ca.gov/>) lists 766 shipwrecks between Del Norte and San Mateo counties, including San Francisco Bay. The National Oceanic and Atmospheric Administration’s Office of Coast Survey charts known shipwrecks and other navigational obstructions through the Automated Wreck and Obstruction System (AWOIS). AWOIS contains information on over 10,000 submerged wrecks in the coastal waters of the United States, each with latitude and longitude and brief historical descriptions. Data can be downloaded at <http://www.nauticalcharts.noaa.gov/hsd/awois.html>.

12.7 WEAPONS DUMPING GROUNDS

From the end of World War I until 1970, the United States Army dumped at least 64 million pounds of chemical weapons, land mines, explosives, and more than 500 tons of radioactive waste at sites offshore of at least 11 states, including California (Bull 2005). Congress banned the process in 1972, but the environmental impacts and human hazards from ocean dumping remain unknown. Records of dumpsites are incomplete and the Army is presently working to locate unknown dumping grounds.

The only Army chemical weapons dumpsite on nautical charts (see NOAA chart 18645) is that of the S.S. William Ralston, which was intentionally scuttled in 13,000 feet of water by the U.S. Army 117 miles west off San Francisco in 1958 with 301,000 mustard gas bombs and 1,479 1 ton canisters of lewsite (Historical Research and Response Team 2001). An additional six mustard gas bombs, 335 one-ton containers of lewsite, 11 one-ton containers of nitrogen mustard, and two mustard gas projectiles were loose dumped from a barge near this same location (Historical Research and Response Team 2001).

Between 1946 and 1970, approximately 47,800 large barrels and other containers of radioactive waste were dumped in the ocean west of San Francisco. The containers were to be dumped at three designated sites, but they litter sea floor area of at least 1,400 km² known as the Farallon Island Radioactive Waste Dump. The exact location of the containers and the potential hazard

the containers pose to the environment are unknown. Sea floor scans indicate that the containers cover an area of approximately 125 km².

12.8 STATE MARINE RESERVES

The three states of the Northern Study Area are in various stages of development of individual marine reserves and other associated areas of special concern.

12.8.1 Washington State

There are no designated marine reserves or marine protected areas in the State of Washington, within the Northern Study Area. A process for nominating and designating marine reserves is underway.

12.8.2 Oregon

Two marine protected areas were designated by the Oregon State Senate in 2009, within the Northern Study Area, at Otter Rock off Depoe Bay and Redfish Rocks off Port Orford. Additional marine reserves are being considered for designation.

12.8.3 California

The State of California has been proactive in nominating and designating marine reserves, although the entire process is under currently under review (State of California 2010). The northern portion of the state, from the Oregon border to Point Arena currently has no marine reserves. The north central coast of California, from Point Arena to south of San Francisco Bay, has several marine reserves and other areas of special concern in the final stages of designation by the state (State of California 2010), as shown in [Figure 12.5](#).

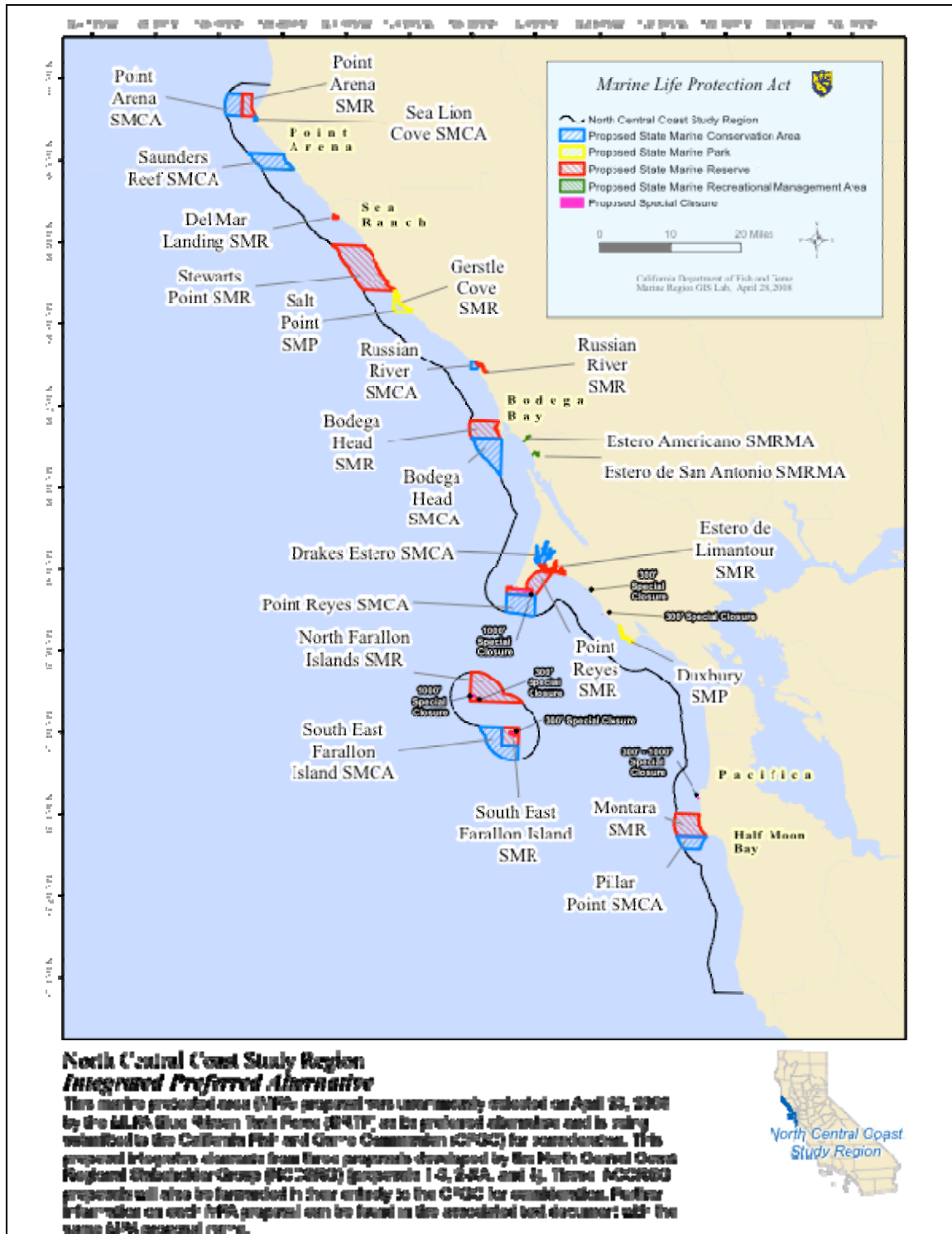

Figure 12.5. Areas of Special Concern in the north central areas under designation by the State of California.

12.9 LIST OF LITERATURE CITED—AREAS OF SPECIAL CONCERN

- Bull, J.M.R. 2005. Special Report, Part 1: The Deadliness Below. The Daily Press. Internet website: www.dailypress.com. April 29, 2009.
- Carlson, R.L. 1990. Cultural antecedents. In: W. Suttles and W.C. Sturtevant. Handbook of North American Indians: Northwest Coast. Washington, D.C.: Smithsonian Institution. 60-69 pp.
- Cordell Bank National Marine Sanctuary. 2009. Sanctuary homepage. Internet website: <http://cordellbank.noaa.gov/>. Accessed April 29, 2009.
- Gulf of the Farallones National Marine Sanctuary. 2009. Sanctuary homepage. Internet website: <http://farallones.noaa.gov>. Accessed April 29, 2009.
- Historical Research and Response Team. 2001. Offshore disposal of chemical agents and weapons conducted by the United States. U.S. Army Research Development and Engineering Command. Historical Research Database no. 26.
- Luckenbach Trustee Council. 2006. S.S. Jacob Luckenbach and Associated Mystery Oil Spills Final Damage Assessment and Restoration Plan/Environmental Assessment. Prepared by California Department of Fish and Game, U.S. Dept. of Commerce, National Oceanic and Atmospheric Administration; U.S. Dept. of Interior, Fish and Wildlife Service, National Park Service. 157 pp.
- Monterey Bay National Marine Sanctuary. 2009. Sanctuary homepage. Internet website: <http://montereybay.noaa.gov/>. Accessed April 29, 2009.
- Olympic Coast National Marine Sanctuary. 2009. Sanctuary homepage. Internet website: <http://olympiccoast.noaa.gov/>. Accessed April 29, 2009.
- Spalding, M.D., H.E. Fox, G.R. Allen, N. Davidson, Z.A. Ferdaña, M. Finlayson, B.S. Halpern, M.A. Jorge, A. Lombana, S.A. Lourie, K.D. Martin, E. Mcmanus, J. Molnar, C.A. Recchia and J. Robertson. 2007. Marine Ecoregions of the World: A Bioregionalization of Coastal and Shelf Areas. *BioScience* 57(7): 573-583.
- State of California. 2010. California Department of Fish and Game website: <http://www.dfg.ca.gov/mlpa/>. Accessed on January 15th 2010.
- U.S. Dept. of Commerce, NOAA National Marine Sanctuary Program (NMSP). 2009. Sanctuary program homepage. Internet website: <http://sanctuaries.noaa.gov/>. Accessed April 29, 2009.
- U.S. Dept. of the Interior, Geological Survey. 2009. Atlas of Gulf of the Farallones Region, Central California, western Coastal and Marine Geology. Internet website: <http://walrus.wr.usgs.gov/farallon/radwaste.html>. Accessed May 26, 2009.

U.S. Dept. of the Interior, National Park Service. 2009. National Park Service mission. Internet website: <http://www.nps.gov/aboutus/mission.htm>. Accessed April 29, 2009.

U.S. Dept. of Interior, National Wildlife Refuge System. 2009. National Wildlife Refuge homepage. Internet website: <http://www.fws.gov/refuges>. Accessed April 29, 2009.

Wilma, D. 2006. Graveyard of the Pacific: Shipwrecks on the Washington coast. Internet website: http://www.historylink.org/index.cfm?DisplayPage=output.cfm&file_id=7936. Accessed April 29, 2009.

13. SOCIOECONOMIC RESOURCES

13.1 DEMOGRAPHICS

The National Ocean Economics Program (2008) provides a full range of the most current economic and socio-economic information available on changes and trends along the U.S. coast and in coastal waters. Based on population data gathered from the USDOC, U.S. Census Bureau (2008a) by the National Ocean Economics Program, there were about 7.9 million persons living in the coastal counties of the Northern Study Area in 2007. Regional population grew at an average annual rate of 1.0 percent over the period 1990 through 2007. Within these coastal counties, in 2007 the majority of the population was concentrated in California (7.2 million in 2007), with smaller populations in Oregon (0.6 million) and Washington (93,000).

[Table 13.1](#) shows the number of communities in the Northern Study Area that have populations of 2,000 or larger and are located within 25 miles of the coast. For consistency across communities, 2000 U.S. Census data are presented. As the table shows, the percentage of the population that lives on or near a coast varies substantially across the region. Nearly 80 percent of the population in the California coastal counties in the Northern Study Area resides within 25 miles of the coast. In contrast, only about 17 percent of Oregon's coastal population resides within 25 miles of the coast.

13.2 ECONOMIC DEVELOPMENT

The National Ocean Economics Program compiles demographic, market, natural resource, and government expenditure data for coastal and ocean economic geographies. Its Market Data site includes the following:

- **Ocean Economy Sector & Industry Data** includes six primary sectors of economic activity that derives all or part of its inputs from the ocean and/or Great Lakes. These economic activities are grouped into sectors and their component industries, as defined by NOEP, to delineate the Ocean Economy.
- **Coastal Economy Sector Data** consist of all economic activity in the coastal region from barber shops to surf shops. The industries that represent these activities are aggregated into the supersectors defined by the Bureau of Labor Statistics. These supersectors are available in different geographic subsets of the coastal region and comprise the NOEP Coastal Economy.
- **Geographic Regions** available in the Ocean Economy are the nation, and the thirty coastal states and their counties. The economic indicators of the ocean sectors and industries are derived from different geographic areas, depending on the industry definition and the resource classifications. Some sectors, such as Tourism & Recreation, are aggregated from Near Shore regions, while others depend on coastal counties for valuation. The Coastal Economy includes Near Shore areas as well as Shoreline, Coastal, and Watershed county aggregates.

- **Economic Indicators** found in the Ocean Economy and Coastal Economy data are the number of establishments, employment, wages, and State Gross Domestic Product (GDP).

Table 13.1.

Population in the Coastal Region of Northern Study Area, 2000^a

State/County	Number of Coastal Communities with a Population ≥ 2,000	Number of Coastal Communities with a Population ≥ 10,000	Coastal Community Population ^b	Coastal Community Population as Percentage of Total County Population ^b
California				
Alameda	19	17	1,431,261	99.1%
Contra Costa	33	23	898,801	94.7%
Del Norte	3	0	11,807	42.9%
Humboldt	10	4	86,154	67.0%
Marin	16	6	211,553	85.5%
Mendocino	1	0	7,026	8.1%
Napa	3	1	85,275	68.6%
San Francisco	1	1	776,733	100.0%
San Mateo	27	16	686,615	97.1%
Santa Clara	18	12	1,541,610	91.6%
Solano	6	5	359,117	91.0%
Sonoma	10	3	278,674	60.8%
Total	147	88	5,476,724	77.9%
Oregon				
Clatsop	3	0	19,809	55.6%
Coos	4	2	32,935	52.5%
Curry	2	0	8,069	38.2%
Douglas	2	0	7,797	7.8%
Lane	1	0	7,263	2.2%
Lincoln	5	0	24,569	55.2%
Tillamook	1	0	4,352	17.9%
Total	18	2	104,794	17.1%
Washington				
Grays Harbor	6	1	37,892	56.4%
Pacific	1	0	2,975	14.2%
Total	7	1	40,867	46.3%

^aCoastal communities are cities or census-designated places located within 25 miles of the coast.

^bOnly coastal communities with populations of 2,000 or more are included.

Source: USDOC, U.S. Census Bureau (2008a)

Based on employment and wage data gathered from the USDOC, Bureau of Labor Statistics (2008) by the National Ocean Economics Program, employment in the coastal counties of the

Northern Study Area was at 3.3 million in 2007 ([Table 13.2](#)). Wages in these coastal counties, in year 2000 values, rose from \$124.7 billion in 1990 to \$195.3 billion in 2007 (dollar values are converted to year 2000 equivalents). Employment is concentrated in the California counties (3.4 million in 2007), with smaller numbers in the Oregon counties (265,000) and Washington counties (31,200). There was some variation in per-employee wages among the states; in 2007, the nominal value of per-employee wages ranged from \$66,061 in the Northern Study Area coastal counties of California to \$31,429 in those of Washington. The average for all coastal counties in the study area was \$63,381.

Table 13.2.

Socioeconomic Environment for the Coastal Region of Northern Study Area, 1990 and 2007

State/County	1990			2007		
	Population ^a	Employment	Wages ^b	Population	Employment	Wages ^b
California						
Alameda	1.304	0.595	\$21,374.83	1.464	0.687	\$33,185.81
Contra Costa	0.804	0.297	\$10,684.71	1.020	0.345	\$15,854.26
Del Norte	0.023	0.007	\$184.82	0.029	0.008	\$229.72
Humboldt	0.119	0.044	\$1,173.04	0.129	0.049	\$1,299.13
Marin	0.230	0.098	\$3,357.02	0.248	0.109	\$5,028.90
Mendocino	0.080	0.029	\$711.20	0.086	0.033	\$858.54
Napa	0.111	0.582	\$23,964.24	0.133	0.556	\$34,717.43
San Francisco	0.724	0.310	\$12,194.98	0.765	0.341	\$20,455.47
San Mateo	0.650	0.856	\$36,486.96	0.707	0.897	\$61,741.09
Santa Clara	1.498	0.147	\$4,327.01	1.749	0.194	\$6,885.85
Solano	0.339	0.045	\$1,283.28	0.409	0.068	\$2,493.29
Sonoma	0.388	0.099	\$3,071.97	0.464	0.128	\$4,567.04
Total	6.271	3.109	\$118,814.06	7.203	3.414	\$187,316.53
Oregon						
Clatsop	0.033	0.014	\$348.97	0.037	0.017	\$425.96
Coos	0.060	0.019	\$506.89	0.064	0.023	\$570.46
Curry	0.019	0.006	\$118.85	0.022	0.007	\$160.20
Douglas	0.095	0.034	\$878.56	0.104	0.039	\$1,041.42
Lane	0.283	0.113	\$2,925.37	0.344	0.151	\$4,306.09
Lincoln	0.039	0.014	\$310.73	0.046	0.018	\$434.52
Tillamook	0.022	0.006	\$130.78	0.025	0.009	\$220.11
Total	0.551	0.206	\$5,220.14	0.642	0.265	\$7,158.76
Washington						
Grays Harbor	0.064	0.023	\$600.72	0.071	0.025	\$668.81
Pacific	0.019	0.006	\$115.35	0.021	0.006	\$146.39
Total	0.083	0.029	\$716.07	0.093	0.031	\$815.20

^a Millions

^b Dollar values are converted to year 2000 equivalents.

Source: Data from USDOL, Bureau of Labor Statistics (2008) and USDOC, U.S. Census Bureau (2008a) compiled by National Ocean Economics Program (2008)

Summary descriptions of the socioeconomic environment of coastal communities in Washington, Oregon, and California can be found in the community profiles prepared by Norman et al. (2006). The authors profile 125 communities that are significantly involved in commercial fisheries in the marine environs of Alaska, Washington, Oregon, and California, including state- and federally-managed waters along the coastlines of these states. The profiles are given in a narrative format that includes four sections. *People and Place* includes information on location, demographics (including age and gender structure of the population, racial and ethnic make up), education, housing, and local history. *Infrastructure* covers current economic activity, governance (including city classification, taxation, and proximity to fisheries management and immigration offices) and facilities (transportation options and connectivity, water, waste, electricity, schools, police, public accommodations, and ports). *Involvement in West Coast Fisheries* and *Involvement in North Pacific Fisheries* detail community activities in commercial fishing (processing, permit holdings, and aid receipts), recreational fishing, and subsistence fishing. The demographic and economic data presented in the profiles are primarily from the 2000 Census of Population and Housing conducted by the U.S. Census Bureau (2008).

The Northern Study Area comprises contrasting types of economic areas. There are a number of large metropolitan areas in the region and a large number of smaller urban and suburban areas in each state. All of the metropolitan areas and some of the larger urban areas have complex economic structures, containing a wide range of industries with wide and diverse labor markets and a comprehensive range of occupations. The large metropolitan area of San Francisco is located off the open coast and hosts extensive port facilities, with waterborne commerce an important aspect of its economy (USDOI, MMS 2007). The smaller coastal urban and semi-urban areas serve a smaller number of more specialized economic functions, including maritime shipping, recreation, tourism, commercial fisheries, and residential retirement communities. The rural, generally undeveloped, segments of the Pacific Northwest and Northern California coastline are characterized predominantly by small communities that rely on the timber and fishing industries, as well as recreation and tourism (USDOI, MMS 2007). Data gathered from the USDOL, Bureau of Labor Statistics (2008) by the National Ocean Economics Program (2008) show the number of establishments in various economic sectors in Northern Study Area coastal counties in 2007 ([Table 13.3](#)).

Table 13.3.

Number of Establishments by Economic Sector in the Coastal Region of Northern Study Area, 2007

State/County	Total	Construction	Financial Activities	Education and Health Services	Information	Leisure and Hospitality	Manufacturing
California							
Alameda	49,291	2,888	3,575	4,869	685	3,391	2,044
Contra Costa	27,933	2,404	3,034	3,038	344	1,913	638
Del Norte	845	62	48	89	10	90	11
Humboldt	5,188	411	325	707	55	396	138
Marin	11,429	1,081	1,206	1,204	236	876	231
Mendocino	4,090	343	236	352	40	351	151
Napa	4,950	528	371	619	44	370	419
San Francisco	44,369	1,686	3,593	3,353	807	3,637	797
San Mateo	22,849	1,895	2,354	2,301	428	1,816	764
Santa Clara	56,305	3,358	4,541	6,144	937	4,092	2,750
Solano	9,726	783	749	1,137	75	750	279
Sonoma	17,766	2,021	1,301	1,803	203	1,268	829
Total	254,741	17,460	21,333	25,616	3,864	18,950	9,051
Oregon							
Clatsop	1,638	204	105	166	23	288	59
Coos	2,011	205	155	266	29	223	84
Curry	881	138	91	100	21	127	23
Douglas	3,157	398	292	412	33	313	135
Lane	10,972	1,253	1,183	1,263	184	1,019	599
Lincoln	1,854	201	172	150	31	320	61
Tillamook	905	117	66	88	12	136	28
Total	21,418	2,516	2,064	2,445	333	2,426	989
Washington							
Grays Harbor	2,639	240	173	201	27	257	97
Pacific	967	80	55	55	13	135	35
Total	3,606	320	228	256	40	392	132

Source: Data from USDOL, Bureau of Labor Statistics (2008) compiled by National Ocean Economics Program (2008)

Chapter 13: Northern Resources—Socioeconomic Resources

Table 13.3. Number of Establishments by Economic Sector in the Coastal Region of Northern Study Area, 2007 (continued)

State/County	Natural Resources and Mining	Other Services	Professional and Business Services	Public Administration	Trade, Transportation, and Utilities	Unclassified
California						
Alameda	83	16,653	7,024	285	7,495	300
Contra Costa	113	7,753	4,570	93	3,852	182
Del Norte	58	272	49	53	102	4
Humboldt	225	1,523	401	123	823	64
Marin	94	2,335	2,395	91	1,605	75
Mendocino	258	1,377	318	69	585	13
Napa	311	878	619	37	731	24
San Francisco	41	17,856	7,127	384	4,844	244
San Mateo	114	5,025	4,172	102	3,739	141
Santa Clara	240	15,738	10,187	153	7,810	356
Solano	166	3,124	982	128	1,507	49
Sonoma	633	4,683	2,263	104	2,568	92
Total	2,336	77,217	40,107	1,622	35,661	1,544
Oregon						
Clatsop	66	170	148	34	375	2
Coos	141	244	198	50	414	5
Curry	52	90	67	18	153	1
Douglas	192	372	297	53	650	11
Lane	238	1,310	1,578	116	2,188	45
Lincoln	76	188	176	44	430	8
Tillamook	72	98	70	33	182	4
Total	837	2,472	2,534	348	4,392	76
Washington						
Grays Harbor	200	807	151	50	437	0
Pacific	111	246	50	26	162	0
Total	311	1,053	201	76	599	0

Source: Data from USDOL, Bureau of Labor Statistics (2008) compiled by National Ocean Economics Program (2008)

13.3 SOCIOCULTURAL SYSTEMS

The sociocultural environment includes social status and roles, groups, and institutions, and the relationships among them, as well as cultural perceptions. The large metropolitan areas of the Northern Study Area represent destinations of opportunity for many individuals, as evidenced by the diverse racial and cultural composition of the region's major cities. Many of the smaller communities maintain sociocultural environments that are less diverse, often supporting a small number or a single cultural group in the most important community economic activity (USDOJ, MMS 2007).

In the Northern Study Area, tribal subsistence activities tend to be similar, focusing primarily on gathering foodstuffs (salmon and shellfish) and traditional medicines. Community profiles prepared by Norman et al. (2006) describe subsistence fisheries in the coastal communities of Washington, Oregon, and California.

The beach, coast, and the ocean itself exist as important geographic, spiritual, and socially constructed components for many Pacific Coast residents (MMS 2007). Recreation, tourism, and ocean-related industries provide substantial income for local community economies. Additionally the beach, the coast, and the ocean provide a “coastal connection” between residents and the sea. For example, a recent public poll showed the extraordinary value that a large majority of California residents place on the State's beaches and the ocean (Public Policy Institute of California 2003).

13.4 ENVIRONMENTAL JUSTICE

Under U.S. Executive Order 12898 all Federal agencies are required to determine if their actions will cause disproportionately high and adverse human health or environmental impacts to low-income, minority, or tribal populations. Such impacts can derive from physical or natural resource changes, such as visual changes in seascapes and construction of onshore facilities in areas that would mostly affect low-income or minority populations.

Data in [Tables 13.4](#) and [13.5](#) show the minority and low-income composition of populations in the coastal counties of the Northern Study Area for 2007 based on data compiled by the U.S. Census Bureau's Population Estimates Program and Small Area Income and Poverty Estimates Program. The number of people in individual minority racial groups (Black or African American, American Indian and Alaska Native, Asian, and Native Hawaiian and Other Pacific Islander) is slightly underestimated in [Table 13.4](#) because only “race alone” data (i.e., the number of persons in each racial category that indicated they were of one race only) are reported. Individuals identifying themselves as Hispanic or Latino are included in the table as a separate entry because these individuals can be of any race. To avoid double-counting, this number includes only individuals also identifying themselves as being “white alone.” Following the Office of Management and Budget's Statistical Policy Directive 14, the Census Bureau uses a set of money income thresholds that vary by family size and composition to determine who is in poverty. If a family's total income is less than the family's threshold, then that family and every individual in it is considered in poverty. The official poverty thresholds do not vary geographically, but they are updated for inflation using Consumer Price Index.

Table 13.4.

Minority Populations in the Coastal Region of Northern Study Area, 2007^a

State/ County	Total Population	Percent Minority	Black or African American	American Indian or Alaskan Native	Asian	Native Hawaiian or Other Pacific Islander	Hispanic or Latino
California							
Alameda	1,464,202	70.0%	190,460 13.0%	5,017 0.3%	356,013 24.3%	190,460 13.0%	282,838 19.3%
Contra Costa	1,019,640	52.5%	93,313 9.2%	4,063 0.4%	134,970 13.2%	93,313 9.2%	209,720 20.6%
Del Norte	29,022	32.2%	1,330 4.6%	1,723 5.9%	745 2.6%	1,330 4.6%	4,220 14.5%
Humboldt	128,864	16.5%	1,328 1.0%	7,079 5.5%	2,560 2.0%	1,328 1.0%	9,014 7.0%
Marin	248,096	24.3%	7,127 2.9%	687 0.3%	13,500 5.4%	7,127 2.9%	31,758 12.8%
Mendocino	86,273	24.9%	527 0.6%	3,637 4.2%	1,165 1.4%	527 0.6%	15,647 18.1%
Napa	132,565	36.0%	2,257 1.7%	1,279 1.0%	6,290 4.7%	397 0.3%	37,502 28.3%
San Francisco	764,976	50.9%	49,358 6.5%	1,919 0.3%	239,537 31.3%	3,377 0.4%	95,305 12.5%
San Mateo	706,984	49.8%	21,058 3.0%	1,540 0.2%	167,937 23.8%	9,281 1.3%	152,132 21.5%
Santa Clara	1,748,976	57.5%	43,999 2.5%	4,751 0.3%	533,003 30.5%	5,643 0.3%	418,629 23.9%
Solano	408,599	49.3%	59,679 14.6%	2,283 0.6%	56,465 13.8%	3,139 0.8%	79,944 19.6%
Sonoma	464,435	27.2%	6,840 1.5%	3,838 0.8%	17,524 3.8%	946 0.2%	97,321 21.0%
Total	7,202,632	52.7%	477,276 6.6%	37,816 0.5%	1,529,709 21.2%	316,868 4.4%	1,434,030 19.9%
Oregon							
Clatsop	37,364	8.8%	253 0.7%	374 1.0%	542 1.5%	63 0.2%	2,113 5.7%
Coos	63,505	7.8%	264 0.4%	1,537 2.4%	660 1.0%	104 0.2%	2,491 3.9%
Curry	21,767	7.3%	56 0.3%	429 2.0%	220 1.0%	21 0.1%	881 4.0%
Douglas	104,119	6.3%	308 0.3%	1,562 1.5%	864 0.8%	90 0.1%	3,821 3.7%
Lane	343,591	10.4%	3,204 0.9%	3,494 1.0%	9,906 2.9%	724 0.2%	19,105 5.6%
Lincoln	45,866	10.7%	205 0.4%	1,309 2.9%	504 1.1%	81 0.2%	2,890 6.3%
Tillamook	25,038	9.9%	79 0.3%	328 1.3%	214 0.9%	55 0.2%	1,852 7.4%
Total	641,250	9.3%	4,369 0.7%	9,033 1.4%	12,910 2.0%	1,138 0.2%	33,153 5.2%
Washington							
Grays Harbor	71,335	12.4%	369 0.5%	3,213 4.5%	989 1.4%	67 0.1%	4,278 6.0%
Pacific	21,490	11.1%	91 0.4%	497 2.3%	442 2.1%	18 0.1%	1,356 6.3%
Total	92,825	12.1%	460 0.5%	3,710 4.0%	1,431 1.5%	85 0.1%	5,634 6.1%

^a Races are one race alone. Hispanic or Latino are white alone.

Source: USDOC, U.S. Census Bureau (2008b)

Table 13.5.

Low-Income Populations in the Coastal Region of Northern Study Area, 2007

State/County	Poverty Estimate (all ages)	Percent Poverty
California		
Alameda	158,223	11.0%
Contra Costa	88,045	8.7%
Del Norte	5,565	22.3%
Humboldt	21,180	16.9%
Marin	16,245	6.8%
Mendocino	13,060	15.4%
Napa	11,004	8.6%
San Francisco	80,277	10.6%
San Mateo	42,006	6.0%
Santa Clara	143,226	8.3%
Solano	37,744	9.6%
Sonoma	40,534	8.9%
Total	657,109	9.1%
Oregon		
Clatsop	4,997	13.6%
Coos	9,179	14.7%
Curry	3,044	14.1%
Douglas	15,294	14.9%
Lane	48,295	14.3%
Lincoln	7,116	15.7%
Tillamook	3,386	13.8%
Total	91,311	14.2%
Washington		
Grays Harbor	10,188	14.9%
Pacific	3,387	16.0%
Total	13,575	14.6%

Source: USDOL, U. S. Census Bureau (2008c)

About half of individuals in the coastal counties of the Northern Study Area identified themselves as minority, while nearly 10 percent of individuals had an annual income in 2007 at or below the poverty line. For the coastal counties in the study area as a whole, the percentage of individuals identifying themselves as minority was substantially more than the nation as a whole (34.3 percent). Similarly the percentage of individuals below the poverty line was smaller than in the United States as a whole (13.0 percent).

Within the Northern Study Area, there is a diversity of population groups. Counties with large urban areas, such as the San Francisco Bay area, have a wide variety of ethnic and racial groups, reflecting heterogeneous sociocultural systems, with cultural centers that include population groups of African, Asian, Native American, Pacific Islander, and Latin American origins. More

rural counties, such as those in the Pacific Northwest, tend to be less diverse, with a smaller number of cultural and racial and ethnic groups present. However, a number of Native American tribes are located on land along the coast within this part of the Northern Study Area, including the Shoalwater Bay Indian Tribe, Coquille Indian Tribe and the Confederated Tribes of the Coos, Lower Umpqua and Siuslaw Indians.

13.5 INFRASTRUCTURE AND SERVICES

There are large port facilities in the Northern Study Area that could provide necessary construction support for an offshore alternative energy facility with minimal modification. Data from the American Association of Port Authorities show that Richmond and Oakland, California, and Portland, Oregon were among the 50 largest U.S. ports in 2007 in terms of cargo volume. [Table 13.6](#) lists the annual volume of goods shipped and received at major ports in the area. Another indication of port size and capabilities is the amount of vessel traffic as measured by the number of port calls. The U.S. Maritime Administration provided estimates of the number port calls by port and commercial vessel type in the Northern Study Area ([Table 13.7](#)). All of the major ports in the study area are connected to well-developed land transportation networks, including rail and highway.

Table 13.6.

Cargo Volume by Port in the Coastal Region of Northern Study Area, 2007 (except where noted)

U.S. Rank	Port/State	Metric Tons
31	Richmond, CA	1,735,848
41	Oakland, CA	15,341,986
120	San Francisco, CA	1,735,848
118	Coos Bay, OR	1,754,824
26	Portland, OR	28,230,670
52	Kalama, WA	9,434,301
74	Longview, WA	4,650,238
133	Grays Harbor, WA	1,129,177
NA	Humboldt, CA	867,269 ^a
NA	Astoria, OR	19,051 ^a

^aData are for 2006.

Sources: American Association of Port Authorities (2008); USDOD, Army Corps of Engineers (2008)

Vessels using the above ports may include military craft (U.S. Navy and Coast Guard); commercial business craft (freighters, tug boats, fishing vessels, ferries, and cruise passenger ships); commercial recreational craft (cruise ships and fishing/sight-seeing charters); research vessels; and personal craft (fishing boats, house boats, yachts, and other pleasure craft) (USDOD, MMS 2007). While many of these vessels generally remain within State waters (i.e., near shore), such as most ferries and personal craft, they influence the availability of port facilities and impact vessel traffic near ports in areas that might be considered for alternative offshore energy projects.

Table 13.7.

Port Calls by Port and Commercial Vessel Type in the Coastal Region of Northern Study Area, 2007

Port	State	All Types Calls	Tanker Calls	Container Calls	Dry Bulk Calls	Ro-Roc Calls	Gas Carrier Calls	Combination Calls	General Cargo Calls
San Francisco	CA	3,945	736	2,046	633	310	40	0	180
Columbia River Ports	OR	2,578	194	154	1,683	292	2	0	253
Coos Bay	OR	35	0	0	35	0	0	0	0
Newport	OR	1	0	1	0	0	0	0	0
Westport	WA	3	3	0	0	0	0	0	0

Source: USDOT, Maritime Administration (2008)

13.6 VISUAL RESOURCES

Various beach types and wetland areas figure prominently in the Northern Study Area. Beach types in Northern California, Oregon, and Washington include rocky shores and sandy beaches (USDOI, MMS 2007). By their nature, sandy beaches are less stable environments than rocky shores, given the potential for seasonal changes in beach profile associated with wind and wave exposure and the effects of nearshore currents. Rocky shore habitats are more abundant from southern Oregon to central California. Wetland and estuarine habitats also figure prominently in the visual landscape of the Northern Study Area; they comprise salt marshes, eel grass beds, freshwater and brackish-water marshes, and mudflats. Wetland habitats may occupy only narrow bands along the shore, or they may cover larger expanses at the mouths of bays, rivers, or coastal streams.

Colder water and weather, combined with rocky shores, reduce beach use in the Northern Study Area; however, the scenery in some areas is spectacular, so oceanfront viewsheds may be highly sensitive to visual changes offshore (USDOI, MMS 2007). In addition, in some areas, residences are located at or very close to the shore; many people choose to live in these areas because of the ocean views from their homes or nearby oceanfront. Seaside residents would potentially be very sensitive to changes visible from the shore; hence viewsheds from seaside residences are of particular concern in analyzing potential visual impacts of offshore energy structures (USDOI, MMS 2007).

13.7 TOURISM AND RECREATION

The Northern Study Area includes approximately 1,100 km (700 mi) of coastline in California, Oregon, and Washington. The Pacific coastline is an outstanding natural resource of great variety, grandeur, contrast, and beauty. It is an important recreational asset to the residents and contributes to the economic success of the tourist industry (USDOI, MMS 2007).

Tourism is a major economic force for some coastal counties in the Northern Study Area, thus any negative changes in tourism would be of major concern. Dean Runyan Associates provides annual analysis of the economic impacts of travel to and through the counties of California

(Dean Runyan Associates 2008a), Washington (Dean Runyan Associates 2008b) and Oregon (Dean Runyan Associates 2008c). As shown in [Table 13.8](#), visitor spending in the coastal counties in the Northern Study Area totaled \$25.1 billion in 2007. Visitor expenditures were concentrated in the California counties (\$22.7 billion in 2007), with smaller levels in Oregon counties (\$2.0 billion) and Washington counties (\$367.9 million). Travel also results in fiscal impacts in the form of State and local tax revenue. Tax receipts from travel in all the coastal counties in the study area totaled nearly \$2.0 billion in 2007.

Table 13.8.

Economic Impacts of Travel in the Coastal Region of Northern Study Area (\$millions), 2007

State/County	Visitor Spending at Destination	Total Direct Tax Receipts (State and Local)
California		
Alameda	\$2,776.80	\$201.00
Contra Costa	\$1,288.70	\$92.20
Del Norte	\$99.40	\$5.20
Humboldt	\$291.70	\$16.90
Marin	\$675.90	\$37.40
Mendocino	\$326.10	\$19.70
Napa	\$972.40	\$65.60
San Francisco	\$8,019.40	\$537.90
San Mateo	\$2,580.60	\$537.90
Santa Clara	\$3,829.60	\$265.80
Solano	\$587.30	\$33.50
Sonoma	\$1,298.50	\$79.40
Total	\$22,746.40	\$1,892.50
Oregon		
Clatsop	\$412.80	\$13.20
Coos	\$191.90	\$5.60
Curry	\$108.40	\$3.10
Douglas	\$191.30	\$6.70
Lane	\$448.00	\$21.10
Lincoln	\$463.60	\$16.00
Tillamook	\$172.40	\$4.30
Total	\$1,988.40	\$70.00
Washington		
Grays Harbor	\$256.10	\$18.10
Pacific	\$111.80	\$6.40
Total	\$367.90	\$24.50

Source: Dean Runyan Associates (2008a); Dean Runyan Associates (2008b); Dean Runyan Associates (2008c).

Based on data gathered from the USDOL, Bureau of Labor Statistics (2008), the National Ocean Economics Program (2008) estimates employment and wages in the ocean-related sectors in which tourism and recreation expenditures occur ([Table 13.9](#)). In the coastal counties of the

Northern Study Area, these wages totaled \$2.5 billion in 2003, the most recent year for which data are available. Employment is concentrated in the California counties (126,100 in 2003), with smaller levels in the Oregon counties (9,900) and Washington counties (801). The ocean-related tourism and recreation employment for all coastal counties in the Northern Study Area was 136,800 in 2003. The multiplier effect is also estimated by the National Ocean Economics Program using IMPLAN, a social accounting and impact analysis software application. In 2003, the total (direct, indirect, and induced) ocean-related tourism and recreation employment for all coastal counties in the study area was 186,700, while total wages were \$4.1 billion.

Table 13.9.

Employment and Wages in Ocean-Related Tourism and Recreation Sector in the Coastal Region of Northern Study Area, 2003

State/County	Employment	Employment with Multipliers	Wages (millions)	Wages with Multipliers (millions)
California				
Alameda	24,020	32,820	\$428.11	\$703.59
Contra Costa	9,610	13,130	\$139.55	\$229.35
Del Norte	720	0,980	\$8.09	\$13.30
Humboldt	3,980	5,440	\$49.96	\$82.12
Marin	8,790	12,010	\$166.17	\$273.11
Mendocino	1,970	2,690	\$26.84	\$44.12
Napa	1,240	1,690	\$20.76	\$34.11
San Francisco	41,120	56,19	\$916.54	\$1,506.34
San Mateo	20,450	27,95	\$385.81	\$634.08
Santa Clara	6,110	8,340	\$126.16	\$207.35
Solano	3,610	4,940	\$47.26	\$77.66
Sonoma	4,460	6,090	\$69.61	\$114.40
Total	126,080	172,270	\$2,384.87	\$3,919.53
Oregon				
Clatsop	2,200	2,970	\$29.77	\$47.52
Coos	2,060	2,780	\$28.16	\$44.94
Curry	950	1,280	\$11.57	\$18.47
Douglas	NA	NA	NA	NA
Lane	700	950	\$9.29	\$14.83
Lincoln	3,450	4,640	\$49.95	\$79.73
Tillamook	540	730	\$5.78	\$9.22
Total	9,900	13,340	\$134.52	\$214.71
Washington				
Grays Harbor	800	1,060	\$10.58	\$16.45
Pacific	NA	NA	NA	NA
Total	800	1,060	\$10.58	\$16.45

Source: Data from USDOL, Bureau of Labor Statistics (2008) compiled by National Ocean Economics Program (2008)

13.8 MILITARY USE AREAS

Military use areas established in numerous areas off all U.S. coastlines are required by the U.S. Air Force, Navy, Marine Corps, and Special Operations Forces to conduct various testing and training missions. Military activities can be quite varied but normally consist of various air-to-air, air-to-surface, and surface-to-surface naval fleet training, submarine and antisubmarine training, and air force exercises. Maps of military use areas in the Northern Study Area are available from NOAA ENC® Direct to GIS, a web portal managed by USDOC, NOAA's Office of Coast Survey (2008).

A region in the Northern Study Area of particular importance to the military is the Northwest Training Range Complex, which is used by the military to conduct training, research, development, and test and evaluation of military hardware, personnel, tactics, munitions, explosives, or electronic combat systems (USDOD, Dept. of the Navy 2008). The range complex consists of numerous individual training areas that stretch from Washington to Northern California (Figure 13.1). Extending 250 nautical miles west from the coastline into the Pacific Ocean, the Northwest Training Range Complex encompasses more than 126,000 square nautical miles of ocean area. Civilian activities currently conducted in the range complex include commercial shipping, commercial fishing, sport fishing/diving, and tourist-related activities. The Navy's procedures for temporarily clearing an area of non-participants for safety purposes does not adversely affect these economic activities because displacement is of short duration (USDOD, Dept. of the Navy 2008). There are no use prohibitions within these areas that would preclude development of alternative energy. Within the Northern Study Area, which extends southward from Grays Harbor, there are three warning areas: W-570, W-93A and W-93B.

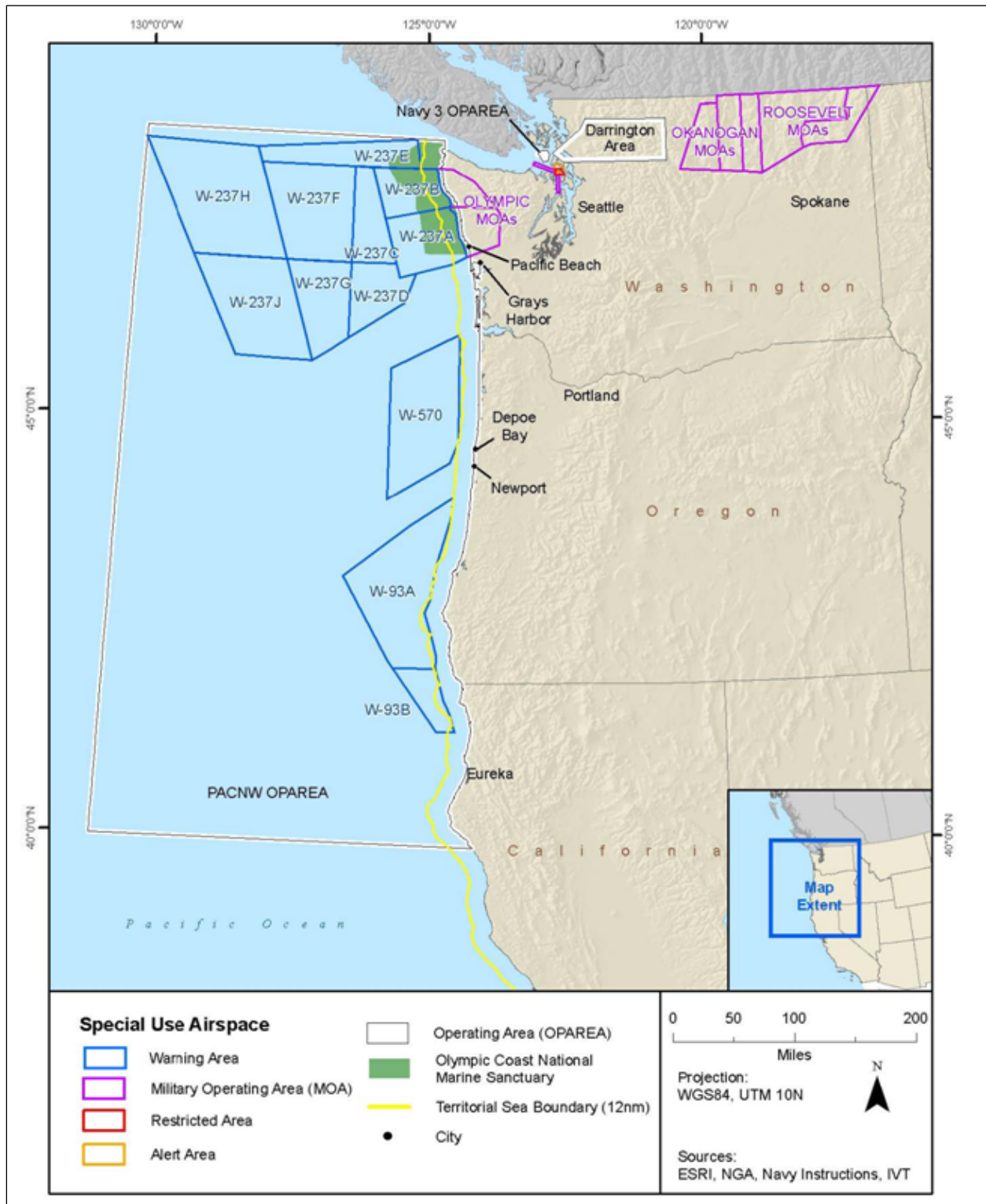

Figure 13.1. Location of Northwest Training Range Complex in Northern Study Area.

From USDOD, Dept. of the Navy (2008)

13.9 COMMERCIAL AND RECREATIONAL FISHERIES

13.9.1 Commercial Fisheries

Information on commercial fish and shellfish landings in the Northern Study Area by weight and value is available from the Pacific States Marine Fisheries Commission (2008a) and California Department of Fish and Game (2008). These data are broken down by county for Oregon and Washington, and by statistical area and port for California.

Commercial marine fishery landings for the Pacific region States of California, Oregon, and Washington totaled slightly more than 397,000 tons (t), worth more than \$424 million in 2007 (Pacific States Marine Fisheries Commission 2008a). Of the three States, California led in total commercial fishery landings, 174,000 t, followed by Oregon, 123,000 t, and then Washington, 99,000 t. While Washington trailed in the quantity of fish landed, it led in the value of landings, \$208 million, exceeding Oregon's value of landings by more than \$113 million and California's by \$88 million.

Many species of fish and invertebrates are caught and landed in commercial fisheries off the coasts of California, Oregon, and Washington. The most important species groups are benthic invertebrates, oceanic pelagic (epipelagic) fishes, demersal fish species, and anadromous species. Important invertebrate species include Dungeness crab and oysters (although oysters are harvested primarily in inland waters). Important targeted fish species include anadromous salmon (chinook, chum, and coho); albacore tuna and swordfish (epipelagic); and sablefish, halibut, Pacific hake (whiting) and rockfishes (demersal).

Each species or species group is caught by various methods and gear types. Traps are used for crab, spiny lobster, and some demersal fish species; sardines are usually caught in surrounding lampara or purse nets; tuna are caught on surface troll lines or longlines; rockfish are generally captured using trawls, set longlines, or trolling rigs; and squid are caught by encircling schools with a round-haul net, such as a purse seine or lampara net.

The most valuable commercial fisheries for California, Oregon, and Washington in 2007 were Dungeness crab. This species accounted for almost 28 percent of the overall commercial fishery value within the region during 2007, and for 22 percent, 39 percent, and 26 percent of the commercial fishery value for California, Oregon, and Washington, respectively (Pacific States Marine Fisheries Commission 2008a). Other invertebrates such as squid, Pacific oyster, sea urchin, and California spiny lobster also contributed significantly to the value of commercial landings. Finfish species that contributed substantially to the overall commercial value of the Pacific region fisheries in 2007 included chinook salmon (\$19 million, 4 percent of regional fishery value), albacore tuna (\$22 million, 5 percent), and sablefish (\$21 million, 5 percent) (Pacific States Marine Fisheries Commission 2008a). In terms of landing weights, Pacific sardine (128,000 t) and Pacific hake (91,000 t) were dominant species in the region overall during 2007. The Pacific sardine, a small coastal pelagic species, was a dominant commercial

fish species for all three Pacific Coast states, accounting for approximately 32 percent of the total weight of landed commercial species for the region.

In California, the commercial fisheries accounting for the largest share of landing weights in 2007 were Pacific sardine (81,000 t), California market squid (49,000 t), sea urchin (5,000 t), Chub mackerel (5,000 t) and Dungeness crab (5,000 t) (Pacific States Marine Fisheries Commission 2008a). The species that brought in the greatest dollar amounts were Dungeness crab (\$27 million), market squid (\$29 million), Pacific sardine (\$8 million) and chinook salmon (\$8 million).

As noted above, California landings are broken down by statistical area and port. Four statistical areas fall within the Northern Study Area: Eureka, Fort Bragg, Bodega Bay, and San Francisco. In total, there are 28 ports in the area that report landings by species (Table 13.10). Landings are reported here at the statistical area level to maintain the same degree of resolution as that employed for Oregon and Washington. In 2007, 18,000 t of commercial fish were landed in these statistical areas. Eureka was the area with the largest quantity of landings, 12,000 t (California Department of Fish and Game 2008). The other three areas followed with landings totaling 3,000 t for the Fort Bragg area, 3,000 for the San Francisco area, and 842 t for Bodega Bay. The total value of landings into these four areas was \$48 million. Of this total, Eureka had the largest landings value of the four areas, \$26 million. San Francisco, Fort Bragg, and Bodega Bay followed with landings values of \$9 million, \$7 million, and \$6 million, respectively (California Department of Fish and Game 2008).

Table 13.10.

Major Commercial Fishing Ports in California Statistical Areas in Northern Study Area, 2007

Statistical Area			
Eureka	Fort Bragg	Bodega Bay	San Francisco
Crescent City	Fort Bragg	Bodega Bay	San Francisco
Eureka	Point Arena	Bolinas	Princeton-Half Moon
Trinidad	Albion	Point Reyes	Alviso
Fields Landing	Elk	Inverness	Berkeley
Shelter Cove		Tomales Bay	China Camp
Humboldt Bay			Richmond
			Emeryville
			Petaluma
			Sausalito
			Oakland
			Vallejo
			Alameda
			Pinole

Source: California Department of Fish and Game (2008)

In Oregon, the commercial species accounting for the largest landing weights in 2007 were Pacific sardine (42,000 t), Pacific hake (43,000 t), pink shrimp (9,000 t), Dungeness crab (8,000 t), Dover sole (5,000 t), Albacore tuna (5,000 t) and sablefish (2,000 t) (Pacific States Marine Fisheries Commission 2008a). The species that brought the greater dollar amounts were Dungeness crab (\$38 million), albacore tuna (\$9 million), sablefish (\$9 million) pink shrimp (\$9 million), Pacific hake (\$7 million), Dover sole (\$5 million), and chinook salmon (\$4 million) (Pacific States Marine Fisheries Commission 2008a).

Coastal Oregon counties that fall within the Northern Study Area are Curry, Coos, Douglas, Lane, Lincoln, Tillamook, and Clatsop. Collectively, these seven coastal counties accounted for 120,000 t of fish, valued at \$91 million (Pacific States Marine Fisheries Commission 2008a). Clatsop County had the largest landings (73,000 t), followed by Lincoln (33,000 t) and Coos (12,000 t). However, Lincoln County's landings were valued the highest at \$30 million, followed by Clatsop (\$27 million) and Coos (\$20 million) counties. At the species level, the value of Dungeness crab landings was the highest for all of the counties: Curry (\$5 million), Coos (\$8 million), Douglas (\$1 million), Lane (\$65,000), Lincoln (\$14 million), Tillamook (\$3 million), and Clatsop (\$8 million) (Table 13.13). Pacific sardine landings in Clatsop (42,000 t) were the largest at the species level across all counties. Pacific whiting landings in Lane County came in second (21,000 t).

In Washington, the commercial species with the largest landing weights in 2007 were Pacific hake (46,000 t), Dungeness crab (10,000 t), albacore tuna (6,000 t), chum salmon (6,000 t), and Pacific sardine (5,000 t) (Pacific States Marine Fisheries Commission 2008a). The species responsible for the greater dollar amounts were Dungeness crab (\$54 million) and Pacific geoduck clam (\$29 million).

Two Washington coastal counties fall within the Northern Study Area: Grays Harbor and Pacific. In 2007, commercial fish landings totaled 9,000 t and 5,000 t for these counties, respectively (Pacific States Marine Fisheries Commission 2008a). Corresponding values of the landings were \$33 million and \$16 million, respectively. The highest valued species for Grays Harbor were Dungeness crab (\$24 million) and Albacore tuna (\$5 million). These two species were also the highest value for Pacific county, worth about \$10 million and \$5 million, respectively.

Overall landing for the Northern Study Area accounted for 38 percent of aggregate landings for California, Oregon, and Washington (Pacific States Marine Fisheries Commission 2008a). Further, the value of landings from the Northern Study Area accounted for 44 percent of total landings for the three states. At the state level, 10 percent of California landings were made in the portion of California that is part of the Northern Study Area. Corresponding percentages were 96 percent for Oregon and 14 percent for Washington. Percentages of the value of landing were 40 for California, 94 for Oregon, and 24 for Washington.

For reported 2007 total landings value, 10 Pacific Coast ports fell within the top 50 United States ports (USDOD, National Marine Fisheries Service 2008). These ports reported landings worth more than \$240 million in 2007. The top U.S. ports in the Pacific region in 2007 in terms of fishery value were Shelton, Washington (\$33 million) Westport, Washington (\$32 million),

Newport, Oregon (\$30 million), Astoria, Oregon (\$28 million), Port Hueneme, Oxnard, Ventura, California (\$27 million), and Bellingham, Washington (\$22 million).

Recently, profiles were developed for 120 fishing communities in California, Oregon, and Washington using basic social and economic characteristics (Norman et al. 2006). The community selection process assessed involvement in commercial fisheries using quantitative data from 2000. Quantitative indicators looked at communities with commercial fisheries landings (weight and value of landings, number of unique vessels delivering fish to a community) and communities that served as home to documented participants in the fisheries (State and Federal permit holders and vessel owners). Indicators were assessed in two ways, as a ratio to the community's population and as a ratio of involvement within a particular fishery. The ranked lists generated by these two processes were combined and communities with scores one standard deviation above the mean were selected for profiling. Of the communities profiled, 50 were from California, 30 from Oregon, and 40 from Washington. Out of these communities 20, 30, and 12 from California, Oregon, and Washington, respectively, were determined to be within the Northern Study Area.

More recently, data envelopment analysis (DEA) was applied to North Pacific and West Coast fisheries to determine the intensity of involvement of West Coast communities in these fisheries (Sepez et al. 2007). Communities assigned the highest possible score in one or more of the ranked lists by the DEA model for commercial fisheries dependence or engagement for the State of California were Bodega Bay, Crescent City, Field Landing, Fort Bragg, Moss Landing, San Diego, San Pedro, Santa Barbara, Tarzana, and Terminal Island. Out of this group of communities, four are located within the Northern Study Area: Bodega Bay, Crescent City, Fields Landing, and Fort Bragg. Eight Oregon communities were identified with high dependence scores: Astoria, Bandon, Garibaldi, Hammond, Harbor, Newport, Port Oxford, and Roseburg. All of these communities fall within the Northern Study Area. Eight Washington communities were indicated to have a high level of dependence on commercial fisheries by the DEA analysis: Anacortes, Bellingham, Blaine, Cathamet, Olympia, Seattle, Tokeland, and Westport. Two of these communities, Tokeland and Westport, fell within the Northern Study Area.

13.9.2 Recreational Fisheries

Sport fishing is an important recreational activity throughout the West Coast of the United States. Information on recreational fish and shellfish landings in the region is available from the Pacific States Marine Fisheries Commission (2008b). In 2007, about 8 million fish were caught by recreational anglers in the Northern Study Area (Pacific States Marine Fisheries Commission 2008b). California anglers caught the majority of these, about 7 million fish. Recreational anglers from Oregon and Washington caught slightly more than a half million fish in each state. During this time period more than 4.5 million fishing trips were taken: about 4 million in California, 187,000 Oregon and 143,000 in Washington.

More than 190 fish and shellfish species have been identified in the recreational catch for California; however, relatively few species made up most of the catch (Pacific States Marine Fisheries Commission 2008b). The species with the highest numbers caught for the three states

was Pacific Mackerel, more than 1 million fish, followed by Black rockfish, 628,000 fish. While the catch of Pacific mackerel was concentrated in California, the catch of Black rockfish was evenly distributed among the three states. During 2007, in the Northern Study Area, recreational anglers took 1 million trips and caught more than 2 million fish.

National Marine Fisheries Service collected and quantified marine recreational fishing expenditures and the economic impacts generated from angler expenditures for 2006 (Gentner and Steinback 2008). Data were collected from anglers fishing in all of the coastal states. Across all of the Pacific coastal states, anglers fishing in California exhibited the highest total expenditures (i.e., the sum of trip, fishing equipment, and durable good purchases). Anglers fishing in California spent an estimated \$3.0 billion on marine recreational fishing in 2006. In comparison, anglers fishing in Washington spent an estimated \$1.4 billion, while those fishing in Oregon spent \$253.1 million. In addition, the highest sales, value-added, income, and employment impacts were generated by angler expenditures in California. The \$3.0 billion spent on retail good and services by anglers in California in 2006 generated \$3.7 billion in total sales within the state, \$1.9 billion in value-added, \$1.3 billion in income, and supported 23,454 jobs. The \$1.9 billion spent on retail good and services by anglers in Washington in 2006 generated \$1.1 billion in total sales within the state, \$606.5 million in value-added, \$393.0 million in income, and supported 11,025 jobs. The \$253.1 million spent on retail good and services by anglers in Oregon in 2006 generated \$283.6 million in total sales within the state, \$154.0 million in value-added, \$103.7 million in income, and supported 2,527 jobs.

13.10 LIST OF LITERATURE CITED—SOCIOECONOMIC RESOURCES

- American Association of Port Authorities. 2008. Port Industry Statistics. September 24, 2008. <http://www.aapa-ports.org/Industry/content.cfm?ItemNumber=900&&navItemNumber=551>.
- California Department of Fish and Game. 2008. Final 2007 California Commercial Landings. <http://www.dfg.ca.gov/marine/landings07.asp>.
- Dean Runyan Associates. 2008a. California Travel Impacts by County. October 8, 2008. <http://www.deanrunyan.com/CATravelImpacts/CATravelImpacts.html>.
- Dean Runyan Associates. 2008b. Washington Travel Data. October 8, 2008. <http://www.deanrunyan.com/impactsWA.html>.
- Dean Runyan Associates. 2008c. Oregon Travel Impacts. January 13, 2009. <http://www.deanrunyan.com/impactsOR.html>.
- Gentner, B. and S. Steinback. 2008. The Economic Contribution of Marine Angler Expenditures in the United States, 2006. Northeast Fisheries Science Center, National Marine Fisheries Service. Woods Hole, MA.
- National Ocean Economics Program. 2008. April 27, 2009. <http://www.oceaneconomics.org/>.
- Norman, K., J. Sepez, H. Lazrus, N. Milne, C. Package, S. Russell, K. Grant, R. Petersen, J. Primo, M. Styles, B. Tilt and I. Vaccaro. 2006. Community Profiles for West Coast and

- North Pacific Fisheries: Washington, Oregon, California, and Other U.S. States. <http://www.nwfsc.noaa.gov/research/divisions/sd/communityprofiles/>.
- U.S. Dept. of Commerce, National Oceanic and Atmospheric Administration Office of Coast Survey. 2008. NOAA ENC® Direct to GIS. May 5, 2009. http://www.nauticalcharts.noaa.gov/csdl/ctp/encdirect_new.htm.
- Pacific States Marine Fisheries Commission. 2008a. Pacific Coast Fisheries Information Network. December 27, 2008. <http://www.psmfc.org/pacfin/>.
- Pacific States Marine Fisheries Commission. 2008b. Marine Recreational Fisheries Statistical Survey (MRFSS) Pacific Coast. December 27, 2008. <http://www.recfin.org/data.htm>.
- Public Policy Institute of California. 2003. It's A Beach State Of Mind: Despite Tumultuous Times, California's GoldenCoast Still Captures Hearts. Press Release. April 1, 2009. <http://www.ppic.org/main/pressreleaseindex.asp>.
- Sepez, J., K. Norman and R. Felthoven. 2007. A quantitative model for ranking and selecting communities most involved in commercial fisheries. NAPA Bulletin 28 (1): 43-56.
- U.S. Dept. of Defense, Army Corps of Engineers, Navigation Data Center. 2008. Waterborne Commerce Statistics Center. April 30, 2009. [http://www.iwr.usace.army.mil/ndc/wcsc/wcsc.htm#2005%20Waterborne%20Commerce%20of%20the%20United%20States%20\(WCUS\)](http://www.iwr.usace.army.mil/ndc/wcsc/wcsc.htm#2005%20Waterborne%20Commerce%20of%20the%20United%20States%20(WCUS)).
- U.S. Dept. of Commerce, Census Bureau. 2008a. American FactFinder. September 24, 2008. http://factfinder.census.gov/home/saff/main.html?_lang=en.
- U. S. Dept. Of Commerce, Census Bureau. 2008b. Population Estimates. June 1, 2009. <http://www.census.gov/popest/overview.html>.
- U. S. Dept. Of Commerce, Census Bureau. 2008c. Small Area Income and Poverty Estimates Program. April 30, 2009. <http://www.census.gov/did/www/saipe/about/index.html>.
- U.S. Dept. of Commerce, National Marine Fisheries Service. 2008. Total Commercial Fishery Landings At Major U. S. Ports Summarized By Year And Ranked By Dollar Value. May 5, 2009. http://www.st.nmfs.noaa.gov/st1/commercial/landings/lport_year.html.
- U.S. Dept. of Defense, Department of the Navy. 2008. Northwest Training Range Complex Draft Environmental Impact Statement/Overseas Environmental Impact Statement. Pacific Fleet Environmental Office. Silverdale, WA.
- U.S. Dept. of the Interior, Minerals Management Service (MMS). 2007. Programmatic Environmental Impact Statement for Alternative Energy Development and Production and Alternate Use of Facilities on the Outer Continental Shelf. U.S. Dept. of the Interior, Minerals Management Service. Washington, D.C.

U.S. Dept. of Labor, Bureau of Labor Statistics. 2008. Databases, Tables & Calculators by Subject. January 8, 2009. <http://www.bls.gov/data/>.

U.S. Dept. of Transportation, Maritime Administration. 2008. Library. April 30, 2009. http://www.marad.dot.gov/library_landing_page/Library_landing_page.htm.

14. SUMMARY OF NATURAL RESOURCES

14.1 PHYSICAL OCEANOGRAPHY

The general ocean circulation along the Northern Study Area can be described by the California Current System, which is comprised of the California Current, the Davidson Current and the California Undercurrent. The California Current is a surface current that flows equatorward along the entire West Coast of the United States between the shelf break and 1000 km offshore. The Davidson Current is a seasonal surface current that manifests itself as a poleward flowing countercurrent to the California Current during the fall and winter months over the continental slope and shelf. The California Undercurrent is a poleward subsurface flow that follows the continental slope. Since currents are strongly influenced by wind-stress, they demonstrate a seasonal variability. During the spring/summer, strong upwelling-favorable winds drive the currents equatorward along the California and Oregon coast while equatorward flow is driven by an equatorward sea surface pressure gradient off the Washington coast. During the winter months off the California and Oregon coast, the upwelling-favorable winds “relax” and allow a poleward sea surface pressure gradient to drive the flow poleward. Buoyancy flows from the Columbia River (also called the Columbia River Plume) in combination with wind-forcing have been observed to flow north along the Washington coast and southwest (offshore) from the Oregon coast. There is also evidence that low-salinity flow from the Strait of Juan de Fuca and the San Francisco Bay behave as a buoyancy flow.

Winds along the Northern Study Area are primarily driven by three persistent large-scale features in the surface pressure field: the Aleutian Low, the North Pacific High, and the Thermal Low. The wind patterns can be divided into two seasons: the spring/summer season and the fall/winter season. During spring/summer mean winds off the Washington coast are weakly southward while mean winds along the California and Oregon coast are strongly influenced by the North Pacific High and directed southward. During fall/winter, mean winds off the Washington coast are strongly influenced by the Aleutian Low and driven northward while mean winds are weakly southward along the California and southern Oregon coast.

The offshore wave climate along the Northern Study Area can be described by four general swell categories: Northern Pacific swell, Southern hemisphere swell, northwest wind swell, and locally generated waves. Northern Pacific swells are generated by powerful storms, typically during the winter. The Southern hemisphere swells are also generated by storms and typically occur during the summer. These swells are characterized as having long wave periods and wave heights lesser than Northern Pacific swells when they arrive at the coast. Northwest wind swells are generated by strong (typically southward) winds along the coast and are characterized as having short wave periods and high wave heights. Locally-generated waves are generated by local winds and typically have short wave periods and low wave heights.

14.2 GEOLOGICAL OCEANOGRAPHY

The Northern Study Area, from Grays Harbor, Washington to San Francisco Bay, CA and extending to 50 miles offshore, consists of low relief coastal ranges onshore, and a continental shelf of highly variable width. Submarine canyons deliver river-derived, generally fine-grained

sediment to deep marine basins. The continental slope is generally wider offshore of Washington and northern Oregon than off Northern California. The area is influenced by tectonic convergence, with accretionary deformation providing structural sea floor expressions. In Northern California tectonic deformation is controlled by the northward-migrating Mendocino Triple Junction. Sedimentation in both areas is strongly controlled by the combination of tectonics and glacioeustatic base-level changes.

Sedimentation on the Northern California shelf is dominated by high levels of fine-grained sediment, proximal to rivers that may have increased by up to seven fold since about 1955, due to changes in land use. In areas of low sediment input, the Northern California shelf is characterized by relict sediment, remaining from the last glacioeustatic lowstand. Approximately 75 percent of the sedimentary organic carbon is generated through primary production in the marine environment.

Sea-floor-connected infrastructure constructed on the Northern California shelf in areas of high sedimentation near rivers would likely be at risk to earthquake, mass movement, and sea floor instability, due to gas/fluid release from sediments and other such hazards, if located along an active fault, or at the outermost edge of the continental shelf. All of these hazards need to be considered in any sea floor infrastructure development.

Areas offshore of Oregon and Washington exhibit seasonal changes in the direction of sediment transport across the shelf; storm-generated waves and currents that erode shorelines as well as coastal and shallowly submerged Tertiary aged outcrops, further contributing sediment to the coastal processes.

Submarine canyons probably erode and enlarge during lowstands, and fill with fine-grained sediment during highstands. Canyons provide temporary storage of sediments being transported to the deep sea floor, and appear to empty every 300-500 years, due to sediment instability, likely triggered by seismic activity. Sediment load appears to have increased offshore of Northern California since 1950, but it has decreased by 75 percent since the late Holocene along offshore Washington.

14.3 CHEMICAL OCEANOGRAPHY AND GEOCHEMISTRY

The chemical composition of the seawater in the Northern Study Area is dominated by terrestrial and atmospheric inputs to the ocean and the vertical distribution of chemicals in the water column. Natural biogeochemical processes may be altered by human activities and are linked to the chemical composition of the ocean, particularly at coastal margins. Plankton is the initial source of detrital particulate organic matter (POM); its community structure plays a key role in controlling the recycling and export of organic matter in the euphotic zone. Organic compounds entering the waters of the Northern Study Area are carried as living organisms and detritus by rivers and streams, with some contribution from methane seeps and deposits and from anthropogenic sources.

Nutrient cycling and subsequent organic matter production are driven primarily by large scale upwelling and mesoscale features such as variations in shelf width or slope, the Columbia River

plume, the San Francisco Bay Plume, the semi-permanent eddy offshore of the Strait of Juan de Fuca, and submarine canyons.

Inorganic compounds entering seawater include nutrients, dissolved oxygen, particulate material, trace metals and sulfur compounds, carried largely by major rivers to the coastal ocean. Organic compounds are carried as living organisms and detritus by rivers and streams, with some contribution from methane seeps and deposits and from anthropogenic sources.

Primary producers such as phytoplankton require dissolved inorganic macronutrients, including forms of nitrogen and phosphorus. Diatoms, the dominant phytoplankton in the Northern Study Area, also need silica (usually silicate- SiO_2) to form their shells. Micronutrients including iron are also needed for plankton growth.

Dissolved oxygen levels are controlled by physical and biological processes, however patterns of dissolved oxygen in the Northern Study Area generally follow those of the conservative physical parameters like temperature and salinity and density. Particulate material has three major sources: riverine discharge, resuspension of bottom material, and growth and excretion from surface activity through the food chain.

There are few direct emissions of industrial material directly into the marine environment as much of the coastline of the Northern Study Area is relatively unpopulated, so that few metals and organic contaminants are delivered to the coastal ocean.

14.4 PHYTOPLANKTON, ZOOPLANKTON AND PELAGIC INVERTEBRATES

The water column of the Northern Study Area is dominated by phytoplankton and zooplankton. Phytoplankton are the energy powerhouse of the ocean, converting water, carbon dioxide, dissolved nutrients and sunlight into the food supply that supports marine organisms from zooplankton through fish, marine mammals and birds, as well as allowing for commercial and recreational fishing by humans. Most phytoplankton are not mobile and are at the mercy of ocean currents, sinking slowly out of the sunlit layer unless they are mixed upwards by turbulence.

Zooplankton are planktonic animals that drift with the ocean currents and graze primarily on phytoplankton. Zooplankton are vertically mobile, allowing them to move toward dense patches of phytoplankton and to retreat to depth during the day in order to lower their metabolic rate. Production rates of zooplankton are dependent on the supply of phytoplankton available to them; decreased rates of phytoplankton production will cause recently hatched zooplankton to starve, lowering production throughout the food web. Areas of the ocean where strong coastal upwelling occurs, like the Northern Study Area, experience strong seasonal phytoplankton growth, supporting strong species diversity and abundance among herbivorous zooplankton and higher trophic levels.

Pelagic invertebrates include large gelatinous organisms such as ctenophores and hydroids, also known as jellyfish, as well as cephalopods such as squid and pelagic crustaceans such as pandalid shrimp. Larger planktivorous and carnivorous organisms, including squid, shrimp and

jellies, tend to follow their food and can also be found in high densities nearshore. Most pelagic invertebrates are secondary consumers of phytoplankton or consumers of small zooplankton. Larger species of squid and many large jellies tend to feed higher up the food chain, targeting fish.

14.5 MACROPHYTES

Macrophytes in the Northern Study Area include macroalgae – commonly called seaweed – eelgrass, and a variety of emergent marsh grasses. Macroalgae are multicellular plants that may be anchored to hard surfaces or free floating, but have no roots. Macroalgae derive nutrients from seawater; eelgrass, a subset of seagrass, and marsh grasses are vascular rooted plants, deriving nutrients from the sediment. Macroalgae, seagrasses, and marsh plants are found all along the coastline of the Northern Study Area wherever appropriate habitat can be found that allows the plants to grow in the photic (or sunlit) zone. Excessive exposure, swift currents, strong waves, and high winds may further limit the presence of these marine plants.

Macrophytes (with the exception of floating algae) must be anchored to hard surfaces (in the case of seaweeds) or in sediment (for seagrasses or marsh plants). Sunlight penetrates only the surface layer of the ocean, ensuring that macrophytes grow close to shore, generally in less than 30 meters of water in the Northern Study Area. Seagrasses are found in soft sediments within embayments throughout the Northern Study Area from the limit of the photic zone subtidally through the intertidal zone. The meadows are dominated by eelgrass *Zostera marina*, with some invasion by the nonnative *Zostera japonica* in the higher intertidal areas. Marsh grasses that dominate the fringes of embayments of the Northern Study Area straddle the range from freshwater to brackish to salt marshes and are dominated by species of emergent plants that best suit the salinity, temperature and nutrient regime locally. Typical salt marsh plants include *Salicornia virginica* (known as pickleweed) and *Carex lyngbyaei*.

Rocky intertidal habitat provides excellent purchase for macroalgae that have developed holdfasts, including a variety of red, brown and green algae most notably several species of *Fucus* and *Sargassum*. Kelp forests are present in the subtidal areas throughout the Northern Study Area, although the beds tend to be episodic and noncontinuous in spatial extent. Seaweeds are some of the most productive plants on Earth and can grow exceptionally fast under optimum conditions of light and nutrients. Eelgrass and marsh grasses grow more slowly, but can accumulate large biomass over the growing season as they are less susceptible to being torn loose by wind and waves.

14.6 BENTHOS

There are a wide variety of benthic habitats and assemblages in the Northern Study Area. Intertidal benthic habitats include mud and sand flats, sandy open beaches, and rocky shorelines. These habitats support a variety of species, some commercially and recreationally valuable such as clams, cockles, oysters, mussels, crabs, and abalone. Sandy subtidal benthic habitat assemblages include mollusks, seapens, seawhips, crabs, shrimp, and sea cucumbers. Rocky subtidal habitats support tunicates, sponges, coralline algae, sea urchins, and other flora and fauna that prefer hard substrate. Benthic and demersal fish species, such as flounder, skates, cod,

sablefish, and rockfish make use of the benthos for protection, feeding, and reproduction. Intertidal and shallow benthic habitats also support a diversity of macrophytes and kelp species. Benthic habitats deeper than 200 m present unique physical, chemical, and biological properties. Increased pressure, decreased temperature and lack of light create different species assemblages than those found in the shallow benthos.

14.7 FISHES

Fish assemblages in the Northern Study Area are varied and complex. There are many harvested species throughout the area, including numerous pelagic species and over 80 groundfish species, not including the variety of prey species supporting the food chain and higher order predators. Endangered and threatened species in the Northern Study Area include several runs of Pacific salmon and green sturgeon. Throughout the different life history stages, the fish of the Northern Study Area inhabit almost every habitat in the region, making comprehensive management and impact assessment challenging. This utilization, when summed for all species, has led NOAA Fisheries to declare virtually all of the continental shelf along the Pacific Coast essential fish habitat.

14.8 SEA TURTLES

Sea turtles inhabit tropical and subtropical seas and are relatively uncommon in northeastern Pacific waters north of Mexico. Historically, four species of sea turtles have been recorded in the northeastern Pacific: the green sea turtle (*Chelonia mydas*), the leatherback sea turtle (*Dermochelys coriacea*), the loggerhead sea turtle (*Caretta caretta*), and the Pacific (or olive) ridley sea turtle (*Lepidochelys olivacea*). All species of sea turtles are listed as either threatened or endangered. All species of sea turtles are omnivorous and major food items often depend on season and preferred foraging ranges. In the Northern Study Area, the seasonal upwelling that supports aggregations of jellyfish (*Chrysaora* spp.) off Northern California and Oregon attract leatherbacks which flock to the area in the autumn months; this area has been proposed as critical habitat by NMFS. Sea turtle populations have been greatly reduced by overharvesting, fisheries by-catch, disease, pollution, and coastal development of nesting beaches. This is a serious problem on the coast of California north of Point Sur, where the gillnet fishery for swordfish and thrasher shark is closed from August through November to protect loggerhead turtles that might be in the area (Carretta 2005).

14.9 BIRDS

All bird species found within the Northern Study Area area are tied to the land for nesting, and a wide variety of life histories have evolved to enable exploitation of the diverse landscape created where the continent meets the ocean. Land resources available along the coast are diverse, from rugged cliffs, offshore islands and sea stacks, to tidal marshes, beaches, and estuarine wetlands. Hundreds of thousands of seabirds are known to nest along the coasts of Washington, Oregon, and California. Countless shorebirds, waterfowl, and other waterbirds thrive along the land-sea interface. Lands along the coast provide diverse stopover habitats used by small birds unable to store sufficient energy for long-distance migration. Migratory shorebirds and waterfowl leapfrog along the coast and stop to refuel while enroute to distant breeding or wintering habitats. However, few of these species could survive without the ample food resources contained within

the waters of the Pacific Ocean. Many seabirds, found both nearshore and in the open ocean, take advantage of seasonally abundant food resources that are concentrated by features of the open ocean. Currents, upwelling, estuaries, and major river plumes provide especially abundant food resources and concentrate birds exploiting those resources. Similarly, shorebirds tied to the land move along the coast to forage on seasonably available food at the land-sea interface.

14.10 MARINE MAMMALS

Marine mammals occurring in the Northern Study Area include seven species of baleen whales (Suborder Mysticeti); all but gray whales and minke are federally listed as endangered species. It also includes 17 species of toothed whales and dolphins (Suborder Odontoceti), two of which are endangered species (sperm whales and Southern Resident killer whales). This region also includes six pinnipeds and also sea otters, two of which are Threatened Species (Steller sea lions, and Guadalupe fur seal). As in other areas off the eastern North Pacific, many marine mammal populations continue to change rapidly in the Northern Study Area, some as a result of protections from high levels of human exploitation that occurred in the past and others in response to apparent environmental changes. Marine mammal populations that appear to have increased in recent years include fin and humpback whales, sea otters, and many pinniped species. There have been major mortality events of harbor porpoise, gray whales, fin whales, and Guadalupe fur seals in this region in the last 10 years. Southern Resident Killer Whales were recently listed as Endangered due to a decline in their population, and there has been a great deal of research and management effort focused on recovery of this population. Human activities that cause impacts on marine mammals in this region include incidental mortality and competition related to fisheries, ship strikes and other vessel impacts, contaminant impacts (especially in Puget Sound), and impacts of underwater sound.

14.11 ECOSYSTEM INTERRELATIONSHIPS

The Northern Study Area has a unique set of geomorphological features that create an environment supporting a rich and stable trophic structure. The pelagic marine food chain is dominated by a tightly linked phytoplankton-zooplankton trophic interaction in the water column, feeding small fishes and supporting substantial resident and migratory fish, marine mammal and seabird populations. The benthic community is largely detrital-based, with a wide variety of polychaetes, benthic crustaceans and mollusks supporting larger macrofauna, including demersal fish. Close to shore, the pelagic and benthic communities rely heavily on nutrient and carbon inputs from land, with most coastal embayments dominated by detrital carbon inputs. Marine-derived carbon is returned to the land in the form of salmonid carcasses, abandoned far upstream in the watersheds surrounding the Northern Study Area.

Within the Northern Study Area, invasions by nonnative species have become widespread, most commonly introduced from ships' ballast water into the bays and navigable river mouths, including the Columbia River.

14.12 AREAS OF SPECIAL CONCERN

There are a number of areas in the Northern Study Area that are designated for special protection or consideration under State or Federal law. National Marine Sanctuaries occupy large portions of the study area in Northern California, with Cordell Bank, Gulf of the Farallones, and Monterey Bay National Marine Sanctuaries encompassing more than 6,800 square miles of the Outer Continental Shelf. Federal regulation prohibits development of energy resources within sanctuary waters.

There are nine coastal National Park Service units in the Northern Study Area, seven of which are clustered around San Francisco Bay. Fifteen National Wildlife Refuges encompass coastal and estuarine features in the study area, serving as critical habitat for migratory and resident birds. Estuarine environments are also protected through the National Estuarine Program, which includes the Lower Columbia River estuary, Tillamook estuary, and San Francisco estuary, and the National Estuarine Research Reserves, which include South Slough, Oregon and San Francisco Bay, California.

Cultural sites are protected by the National Historic Preservation Act. There are thousands of known shipwreck sites in the Northern Study Area and indigenous prehistoric sites are common near all major rivers, estuaries, and many coastal areas.

Finally, weapons dumping grounds have been mapped offshore of San Francisco and additional more unmapped sites are suspected in the Northern Study Area. Toxic chemicals and nuclear material can be released into the marine environment if dumping sites are disturbed. The dumping areas that appear on nautical charts are generally more than 50 miles offshore, beyond where alternative energy sites are likely to be located. Unmapped dumping site locations are unknown but are presumed to also be considerable distances offshore.

PART II—NORTHERN STUDY AREA: IMPACTS

Introduction: A Note About Impacts

This literature synthesis describes the literature on potential impacts to various oceanographic resources from activities conducted as part of offshore alternative energy development. While it attempts to focus on impacts that would be felt by resources within the study area, it is not a specific analysis or prediction of effects from a given project in a given location.

In the context of environmental analyses required by the National Environmental Policy Act (NEPA), impact levels are typically characterized along a continuum, from negligible to major, by their extent, duration, magnitude, and likelihood of occurrence. Throughout Part II, where these terms are used, they have the interpretations given below. Because physical resources and socioeconomic resources are so different, different interpretation of impact terms is appropriate; both definitions are presented below.

Impact Levels for Biological and Physical Resources

Negligible

- No measurable impacts.

Minor

- Most impacts to the affected resource could be avoided with proper mitigation.
- If impacts occur, the affected resource will recover completely without any mitigation once the impacting agent is eliminated.

Moderate

- Impacts to the affected resource are unavoidable.
- The viability of the affected resource is not threatened although some impacts may be irreversible, OR
- The affected resource would recover completely if proper mitigation is applied during the life of the project or proper remedial action is taken once the impacting agent is eliminated.

Major

- Impacts to the affected resource are unavoidable.
- The viability of the affected resource may be threatened, AND
- The affected resource would not fully recover even if proper mitigation is applied during the life of the project or remedial action is taken once the impacting agent is eliminated.

Impact Levels for Socioeconomic Issues

The following impact levels are generally used for the analysis of demography, employment, and regional income; land use and infrastructure; fisheries; tourism and recreation; sociocultural systems; and environmental justice.

Negligible:

- No measurable impacts.

Minor:

- Adverse impacts to the affected activity or community could be avoided with proper mitigation.
- Impacts would not disrupt the normal or routine functions of the affected activity or community.
- Once the impacting agent is eliminated, the affected activity or community will return to a condition with no measurable effects without any mitigation.

Moderate:

- Impacts to the affected activity or community are unavoidable.
- Proper mitigation would reduce impacts substantially during the life of the project.
- The affected activity or community would have to adjust somewhat to account for disruptions due to impacts of the project, OR
- Once the impacting agent is eliminated, the affected activity or community will return to a condition with no measurable effects if proper remedial action is taken.

Major:

- Impacts to the affected activity or community are unavoidable.
- Proper mitigation would reduce impacts somewhat during the life of the project.
- The affected activity or community would experience unavoidable disruptions to a degree beyond what is normally acceptable, AND
- Once the impacting agent is eliminated, the affected activity or community.
- May retain measurable effects indefinitely, even if remedial action is taken.

15. PHYSICAL OCEANOGRAPHY

15.1 EFFECTS ON AIR-SEA FLUX AND UPWELLING

Friction between air flow and a rough surface, such as the ocean, leads to turbulent flow. Turbulent flow is the resulting chaotic motion of the air responsible for the transfer of momentum from the air to the ocean surface upon which the air is acting. This process is called wind stress. The turbulent air flow enhances the exchange of energy in the forms of momentum flux, sensible heat flux, and latent heat flux. While momentum energy flux depends primarily on the bulk speed difference between the air and water, sensible and latent heat fluxes also depend on the temperature differences between the atmosphere and water and these fluxes can go from air to ocean or ocean to air.

Exchanges between the atmosphere and ocean are most easily measured in the atmospheric surface layer where the fluctuating vertical velocity transports fluid properties up and down. The resulting Reynolds fluxes describe how momentum is transferred to the ocean from the atmosphere (wind stress) and how heat (both sensible and latent) is transferred to and from the ocean. Wind stress depends on the square of the wind speed and the roughness of the surface (e.g., the coefficient of drag over flat desert plains is less than that over heavily forested mountains). Compared to most land surfaces, the ocean has a relatively small drag coefficient. The ocean, however, is unique in that as winds increase the ocean surface becomes rougher and the drag coefficient increases. Because of this variation, wind stress is usually calculated empirically and cannot be determined from basic principles. Large and Pond (1981) provide an example of an empirically determined equation for wind stress. Similarly, the transfer of energy as sensible heat (heating and cooling) and latent heat (evaporation) is also determined empirically.

Since the coefficient of drag is typically smaller offshore than over land surfaces, ambient turbulence levels offshore are also lower offshore. Typical values of turbulence intensity at turbine hub height (76 m) are six to eight percent offshore and 10 to 12 percent over land where turbulence intensity (I) is calculated as the standard deviation of wind speed over the wind speed (Barthelmie and Pryor 2006).

Very little research is available on the effects of wind turbines and wave-energy-capturing (WEC) devices on air-sea flux and upwelling. Research has been conducted, however, on wind turbine and wind park performance for existing wind parks in Europe (Barthelmie and Pryor 2006). Although this research is geared toward improving wind park performance rather than determining the effects on the air/sea environment, these studies do provide information on the effects that wind turbines have on wind speed, wind energy, and turbulence.

Little is documented on the impacts of wind turbines on the physical setting. The amount that wind turbines will affect air-sea flux (since they increase turbulence and decrease wind speeds) and whether these effects are significant is a data gap. Wind turbines and WEC devices need to be monitored to determine how much they disrupt the air flow over the water surface and how much of the ocean surface is affected, in order to evaluate how wind turbines and WEC devices

potentially also affect air-sea flux. Wind turbines and WEC devices need monitoring to determine if they disrupt the flow of surface currents, and if any disruption is significant enough to affect upwelling. Most likely the effects of wind turbines will be minor (and the effects of WEC even less) since air-sea flux and upwelling occur over much broader regions than the area that would be disrupted by energy-capturing devices. Regions of upwelling over coastal waters are typically thousands or tens of thousands of square kilometers; air-sea flux acts on a similar scale. On a more local scale, however, significant effects could be felt.

Wind turbines increase turbulence in their wake, which would tend to increase air-sea flux. At the same time, since wind turbines extract energy from the wind, the mean wind velocity in the wake of turbines will decline. This effect would tend to decrease air-sea flux. Barthelmie and Pryor (2006) performed a study on power losses and turbulence intensity in wind turbine wakes at the Middelgrunden offshore wind farm near Copenhagen, Denmark. This study provides some insight on the effects of wind turbines although the emphasis was on quantifying and maximizing turbine efficiency.

The Middelgrunden offshore wind park consists of 20 two-megawatt Bonus wind turbines placed in a single row with a hub height of 64 m and rotor diameter of 76 m. Turbulence levels behind wind turbines are at a minimum at wind speeds of about 11 m/s for which turbulence intensity measured 6.5 percent of the air flow (Barthelmie and Pryor 2006). Over the open ocean, without the influence of wind turbines, turbulence intensity increases with an increase in wind speed due to greater sea roughness. The amount of turbulence potentially affecting the sea surface in the lee of wind turbines is unknown, and depends on the joint impact of the ambient turbulence and the turbulence created by the turbines.

Turbulence from wind turbines decreases energy in their wake. A 20 percent increase in turbulence, along with a 20 percent loss of power production, was recorded at a second turbine located in the first turbine's wake (Barthelmie and Pryor 2006). The lowest efficiencies/highest wake losses occur at wind speeds of 6-10 m/s; a gradual increase in efficiency occurs with increasing wind because there is less impact on the turbines downstream in the wake. The diameter of the wake increases linearly behind a turbine according to the relationship $D_w = D + 2kX$ in which D is the diameter of the turbine, the wake decay coefficient $k \approx 0.04$, and X is the distance from the turbine. The wake effect on the surface, therefore, is not immediate. According to the above relationship, the wake reaches the ocean surface 650 m behind the turbine for a turbine diameter of 76 m.

Turbulence brings air that is aloft down to the surface. If the marine boundary layer was thin enough, turbulent mixing from wind turbines could potentially enhance the transport of relatively warm dry air above the cool moist air of the marine boundary layer to the surface. Such a shift would cause a small increase in sensible heat flux and a small decrease in latent heat flux, and should be monitored to estimate whether or not this change is significant.

15.2 EFFECTS ON WAVE ENERGY AND DIRECTION

WEC devices extract potential and/or kinetic energy from the waves in order to produce energy. Since essentially all wave energy along the northwest coast is directed toward shore, the

extraction of wave energy will decrease the amount of wave energy reaching the shore. The extent of this decrease will depend on how much energy the WEC devices capture. This quantity depends on the type of device, the number of devices, and how widespread the devices are. The type of device further dictates the efficiency of energy capture and the amount of blocked energy.

An enormous amount of energy reaches the coastline along the northwest United States. Theoretically, sufficient wave energy exists along the northwest coast to power California, Oregon, and Washington, although capturing the full amount is unrealistic. The precise amount depends on technological, environmental, economic, social, and legal limitations. This section describes the effects of decreased wave energy reaching the coast due to WEC devices.

[Chapter 1.6](#) describes the wave climate along the northwest coast. Wave climate, which includes directional energy spectrum, variability timescales, are critical for littoral processes, sediment transport, and available energy. Two excellent resources on the effects of WEC devices on wave energy reaching the shore are: “Developing Wave Energy in Coastal California: Potential Socio-Economic and Environmental Effects” (prepared for the California Energy Commission) (Hapke et al. 2006) and the “EPRI Oregon Offshore Wave Power Demonstration Project” (Bedard et al. 2005). Much of the information in this section was drawn from these two reports.

WEC devices are expected to extract three to five percent of incident wave energy (Hapke et al. 2006). The extraction of energy will result in a “wave shadow” of reduced wave energy in the lee side of the devices. Due to wave diffraction, a certain amount of energy will fill in behind the device, creating a triangular wave shadow of reduced energy. The consequences of reduced wave energy reaching the shore include smaller waves, less cross-shore sediment transport and increased beach building, reduced longshore sediment transport, and less turbulence and mixing in the nearshore.

Four important aspects of WEC devices will affect the wave energy reaching the shore: device width, power output per device, power output per unit length, and power output per unit width (Bedard et al. 2005). The device width is the length of the wave crest absorbed for energy. A device that is not very wide but has a high power output can have a different impact on the energy reaching the shore than a wide device that produces the same total power output. [Table 15.1](#) presents information on the energy capture of four devices. The power productions are lower than the capacity power rating for each device, which is presumably achieved under more energetic wave conditions. The percent power extracted from waves is the ratio between power production per meter of crest-length and the incident wave energy flux. Note that the Pelamis extracts twice the available energy in a 3.5 m length of wave crest, most likely due to wave energy refracted inward along the entire length of the device (Largier 2008).

Table 15.1.

Energy production during trials for WEC devices deployed off Oregon, with incident energy flux of 21.2 kW/m.

Device	Device width (m)	Power out per device (kW)	Power out per length (kW/m)	Proportional power out
Aqua Energy	6	17	2.83	13%
Pelamis	3.5	153	43.7	206%
WaveDragon	260 ¹	1369	5.27	25%
Energetech	35	259	7.40	35%

¹ Larger WaveDragon prototypes are proposed for future commercial use, corresponding to higher power productions. This prototype was chosen because its power production was already evaluated for a wave energy density of 21.2 kW/m (EPRI, 2006)

Source: Largier et. al.

From Behrens et al. (2008).

To estimate the loss of wave energy incident on the nearshore and shoreline, an array of devices must be considered (Largier 2008). The power output in [Table 15.1](#) refers to the amount of energy captured by the device and not the energy lost by the wave. More energy is likely lost by the wave than captured by the device. A certain amount of wave energy will be lost by wave energy reflection, turbulence, and friction. It is also likely that different devices will cause different amounts of wave energy loss. In addition, all these factors will likely change in different wave climates. [Table 15.1](#) is based on a 21.2 kW/m incident wave energy flux off Oregon. Different regions will have different energy fluxes, wave periods, wave heights, and directional spectra. All of these factors will have to be taken into account when deciding which type of devices will be chosen and how they will affect the amount of energy reaching the shore.

As a WEC device extracts energy, wave heights will be reduced behind the device as the waves approach the shore. Wave diffraction tends to cause wave energy to fill in behind the device causing a triangle-shaped reduction in energy (Behrens et al. 2008). Diffraction is a process in which the energy of a wave is transferred along the wave crest, perpendicular to the direction of wave propagation ([Figure 15.1](#)). The triangle-shaped reduction in energy behind a device is called a “wave shadow.” ([Figure 15.1](#) shows only one side of the diffraction; therefore, it does not show the triangular shadow.) At a certain distance behind the device (and past the apex of the wave shadow), the diffracted wave energy will begin to add constructively (Komar 1998). The wave period, wavelength, and device width will determine the length of the wave shadow.

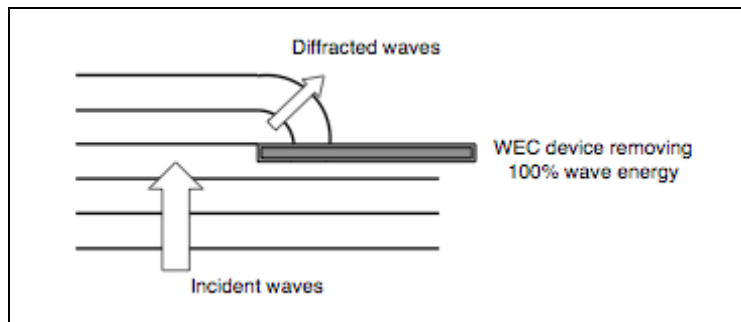

Figure 15.1 Schematic of wave diffraction into the wave shadow behind a WEC device (or breakwater) that extracts 100 percent of the incident wave energy.

In reality, only about 15 percent of the wave energy will be extracted.

From Bedard et al. (2005).

In instances where WEC devices line up perpendicular to the wave direction, the gap between devices, as well as the device itself, influence wave refraction and the redirection of wave energy. The factors that influence wave diffraction are the width of the gap between obstructions, angle of wave approach, and wavelength. For large gaps, incident waves pass through relatively unchanged. For narrow gaps—on the order of one or two wavelengths—wave heights are significantly reduced (Penney and Price 1952). Immediately behind a WEC device that extracts 10 percent of the wave energy flux, one can expect waves to be 10 percent less powerful (or wave heights to be reduced by 5.1 percent); the waves remain at full strength away from the device (Behrens et al. 2008). At a certain distance down-wave from the device, the wave shadow will be filled in until energy is again homogeneous along the crest.

If 10 percent-extraction WEC devices cover 10 percent of the alongshore length, then a general one percent loss in wave power (or 0.5 percent reduction in wave height) occurs at distances beyond the shadow zone (Largier 2008). A localized minimum of wave energy along the shoreline will exist if the shoreline sits within the wave shadow. If the shoreline is beyond the wave shadow, the homogeneous loss of energy at the shoreline will be a function of the proportional energy loss at each device and the spacing of the devices.

A theoretical investigation of the energy loss due to one 2250-m-long and 1110-m-wide array of Pelamis devices in a commercial-scale plant design found that a 2-m significant wave height (15.2 kW/m wave energy flux) decreased to 1.7 m (11.8 kW/m energy flux) down-wave of the plant (Bedard et al. 2005). This decline translates to a 22 percent reduction in wave energy and a 12 percent reduction in wave height. A total loss of no more than 5 to 10 percent of the initial energy would occur along a 12-km stretch of shoreline.

15.3 EFFECTS ON CURRENTS AND LITTORAL PROCESSES

Waves slow as they interact with the bottom in shallow water near the shore. The interaction with the bottom begins at depths less than $L/2$ in which L is the wavelength. Eventually, inshore

of depths of $L/20$, wave speed (c) follows the relationship $c = (gh)^{0.5}$ in which g is the acceleration due to gravity and h is water depth. When waves slow as they approach the shoreline, their period does not change, so their wavelength must decrease while energy is conserved. This shift causes a wave to increase in height and steepness, a process known as shoaling. Eventually, the wave becomes unstable and breaks. For a straight beach with a uniform profile, waves will collapse in a characteristic “breaker line” at a water depth at which they reach the critical height to depth ratio. When waves break, they release energy. This release in energy affects the nearshore region through turbulence, currents, and wave runup ([see section 1.6](#)). A decrease in wave energy or wave height will change the critical depth at which waves become unstable, changing the breaker-line distance from the shore. In turn, this shift in position will change the cross-shore influence of wave-induced turbulence, currents, and wave runup.

Turbulence is a property of water motion that involves chaotic water movement on multiple scales, resulting in nonlinear three-dimensional flow patterns. Turbulence serves many purposes to benthic communities, including transport of small particles, food, and sediment (Behrens et al. 2008). It suspends particles in the surf zone, making them more susceptible to current transport. A decrease in wave energy weakens turbulent forcing. This weakening decreases both the quantity of particles suspended in the surf zone and the amount of particulate matter that the currents can transport. Sediment grains of varying sizes have different thresholds of current velocities necessary before they will be picked up for transport. The stratification of sediment grains in the surf zone, therefore, will be affected by decreased turbulence.

The variance of wave heights throughout the year typically causes a long-term balance in the amount of sediment supplied to and taken from a beach. With reduction of wave heights (as with use of offshore WEC devices), the beach could experience net accretion and increased beach steepness (Largier 2008). Because the breaker line shifts shoreward with smaller waves, the region where the breaker line used to be will experience less turbulence. Nearshore regions, however, could experience additional turbulence despite wave energy reductions since less energy will be dissipated by the offshore sand bars as the waves approach the shore.

Turbulence also causes mixing on a much smaller scale that affects individual organisms (Behrens et al. 2008). This small-scale turbulence delivers nutrients and food, while removing waste substances away from the organisms. For example, reductions in wave height could decrease the delivery of nutrients to individual blades of macrophytes because in the absence of turbulent mixing a thicker viscous sublayer of water greatly reduces the exchange rate of nutrients and waste between the blades and the water.

Longshore currents are generated by a combination of obliquely breaking waves and longshore variations in wave set-up on the beach. When waves break at an angle to the shore, an onshore-directed radiation stress results in wave set-up of sea level and a longshore-directed radiation stress that drives the longshore current (O'Rourke and Leblond 1972; Komar 1998). A decrease in wave energy will typically cause a decrease in longshore currents, as these currents are directly proportional to wave-energy density. Exceptions can occur, however. Waves of lesser height that approach the shore at an angle will be refracted by the bottom closer to shore. Such

waves will not be refracted as much as larger waves and will break at a steeper angle to the shoreline. This situation will cause longshore currents to increase. Whether this increase is sufficient to make up for the decrease in wave energy depends on location-specific characteristics, the angle of the approaching waves, and the amount of wave energy diminished by WEC devices.

As mentioned in Behrens et al. (2008), researchers have developed several expressions to calculate longshore sediment flux. The distinctions among them are most likely due to site-specific differences. All expressions confirm that longshore sediment flux is strongly related to breaker wave height and incident angle. [Table 15.2](#) shows multiple relations between the reduction in wave height and the decrease in longshore sediment flux. Although the dependence on wave breaker height is clearly evident, these expressions have been derived for straight beaches with regular offshore topography; they may not completely represent the longshore flux that would occur on nonuniform beaches.

Table 15.2.

Reduction in longshore sediment flux corresponding to decreases in wave breaker height, calculated with different published relationships

Equation	Reduction in wave breaker height	Decrease in longshore sediment flux
Inman and Bagnold (1963)	5%	12.0%
	10%	23.1%
Inman and Bagnold (1963) Kraus et al. (1982)	5%	9.7%
	10%	19.0%
Kampuis (1990)	5%	7.4%
	10%	14.6%

From Behrens et al. (2008)

Similar to longshore sediment transport, cross-shore sediment transport is directly related to wave height. Beaches both moderate and respond to wave energy. The shape of the beach has a direct impact on how waves break. The beach then adjusts itself to varying degrees of wave energy. Beaches typically respond to increased wave energy by reducing overall slope and creating an offshore sand bar that relocates the breaker zone further offshore. This shift allows dissipation of wave energy further offshore, protecting the beach. A decrease in wave energy moves sand back toward the beach and causes the beach to steepen.

Whether sediment is transported offshore or onshore depends on wave steepness, H_{∞}/L_{∞} . Below a critical value, sediment flux is toward shore; above that value, erosional flux moves sediment away from the shore (Dean 1973). This relationship provides a basis for determining whether the beach is acquiring or losing sediment—an outcome that depends directly on wave height, which offshore WEC devices will alter. According to the above relationship, long-term

reduction of wave heights would cause net sediment accretion. With wave energy reduction, the diminished offshore sand bar could leave the beach vulnerable to episodic intense wave activity. Typically slow seasonal changes in beach morphology occur; instead, sudden intense erosion episodes followed by slow re-accretion could become the norm.

Waves have a substantial impact on the morphology of estuary and lagoon inlets. The aerial and cross-sectional geometry of these inlets is controlled by the local sediment flux (Behrens et al. 2008). Inlets usually maintain a balance between sedimentation from wave-driven currents and scouring from tidal and river flows. If a decrease in wave energy causes an increase in beach accretion, this balance could be disrupted, the scouring from outflow may not be able to overcome the sediment buildup, and the inlet could close. Determining if an inlet will close proves difficult, however, due to the physical difficulty and costs associated with accurate measurement of key parameters such as longshore or cross-shore sediment transport, cross-sectional area, velocities within the inlet, and sediment flow. Thus, few studies have obtained adequate data or well-defined results and they are usually qualitative (Komar 1996; Ranasinghe and Pattiaratchi 2003). An index using the expression $B = \Omega/P$ where Ω is the annual volume of sediment transported in longshore currents in the vicinity of the inlet, P is the tidal prism, and B is a nondimensional inlet stability index (Bruun and Gerritsen 1960) is a way to approximate whether an inlet will remain open. Based on this relationship, a decrease in wave energy increases the likelihood that an inlet will remain open to the ocean, assuming that the tidal prism remains constant. Decreased wave energy, which leads to a decrease in currents, will likely cause inlets to experience less migration, channel adjustment, and closure.

The lack of research in the fields of sediment transport and inlet morphology makes it difficult to assess the impacts of reducing wave energy in the nearshore zone. Some general results in the research, however, offer basic conclusions on the impacts of wave energy depletion. Coastlines are dynamic and adjust to accommodate the amount of energy supplied by waves, as exemplified by the generalized seasonal beach model. This model shows a single concave profile during the summer; in winter, increased wave energy causes development of an offshore sand bar that dissipates wave energy further from the shoreline.

A reduction in wave energy corresponds with lower wave heights and steepness. Such a reduction would prevent formation of an offshore bar, lead to a steeper beach face, and possibly upset the long-term balance of sediment erosion and accretion on the beach (Largier 2008). Longshore currents most likely weaken in response to reduced wave energy, leading to a decrease in sediment transport along the coast. Finally, reduced sediment transport from wave-driven currents will decrease the tendency of coastal inlets to move laterally, adjust their geometry, and close. This situation would result from an increased ability of inlet channel currents driven by waves and river flow to scour the smaller supply of sediment that arrives at the mouth of the inlet.

Wave height and incident angles are the most important parameters in determining the effects of reduced wave energy due to WEC devices (Largier 2008). This section provided an outline of the possible outcomes of wave energy reduction. Whether a 5 to 10 percent reduction of energy

over a small section of coast will have a significant impact on coastal dynamics remains difficult to determine due to limited research and the lack of implementation of large-scale WEC projects.

15.4 SUMMARY AND DATA GAPS

Since turbulence increases and wind speed decreases in the wake of wind turbines (Barthelmie et al. 2007), wind turbines will have an affect on air-sea flux and upwelling. The extent to which wind turbines will affect air-sea flux and upwelling over an open coastline is not well known, although the impact is expected to be small since wind energy facilities cover only a small area compared to the entire wind field. Although little research is available regarding the physical affects on the ocean, open ocean wind parks exist in Europe and can provide a basis for future studies.

The available research on open ocean wind parks is geared toward performance but can be used to suggest possible effects on the physical oceanography and coastal shoreline. Barthelmie et al. (2007) observed a 20 percent increase in turbulence and 20 percent decrease in power in the wake of a wind turbine. In reference to wind turbine performance in another wind turbine's wake, lowest efficiency/highest wake losses are at winds speeds between 6 – 10 m/s.

The extraction of wave energy by WEC devices will decrease wave energy reaching the shore (Largier 2008). The amount of energy WEC devices extract will depend on the type, number, and overall footprint of the devices. Very little research is available on the effects of WEC device energy extraction on the shoreline and there are no large-scale WEC projects in existence.

WEC devices are expected to extract 3 - 15 percent of the wave energy (Hapke et al. 2006). The extraction of energy will result in a triangular-shaped “wave shadow” in the lee of WEC devices due to wave diffraction. A reduction of wave energy (corresponding to a decrease in wave heights) will change the incident wave angle and the distance from shore that waves become unstable and “break.” This will affect wave shoaling, wave-induced turbulence and mixing, cross-shore sediment transport and beach accretion, longshore sediment transport, and wave runoff (Largier 2008). A decrease in wave height is expected to cause net sediment accretion and increase beach steepness. A decrease in wave-induced turbulence is expected to decrease sediment transport and affect the delivery of nutrients to organisms (Largier 2008).

Before either wind parks or WEC energy extraction devices are deployed, there first needs to be an extended period of wind and wave data collection to accurately characterize the conditions. For wind data this will entail deployment of surface meteorological buoys. Enough buoys will have to be deployed to capture the spatial variation of the wind environment. Such data can then be used to inform the deployment of wind parks.

Similarly, extensive wave data need to be obtained prior to the deployment of any WEC devices. In this case a combination of CDIP-type buoys and arrays of HF radar is recommended to capture the spatial variability of the local wave regimes. Multi-year data sets should be collected and analyzed before any permits for either wind parks or WEC devices are issued. All the measurements should continue with the deployment of energy-extracting devices and an

independent panel of scientists should be engaged to verify the effects, both positive and negative of the energy extraction efforts.

In areas where wind and wave power extraction devices are currently in place, there is a critical need to monitor the physical environment to detect any developing environmental changes associated with the devices. Environmental alterations are potentially different for a single device than they are for an array of devices (e.g. scour vs. group scour). This type of information will help to frame potential impacts for planned device placements within the U.S. OCS. In summary, key data gaps are:

- Information on any decrease in wind turbulence and/or wind speed associated any devices. This information is necessary to estimate any changes in air-sea flux.
- Information on any decrease in surface currents. This information could be used to estimate changes in upwelling.
- Information on any decreases in mixing related to the structures or anchors. This information could be used to estimate any changes in water chemistry that might lead to changes in productivity, particularly in the area of the Columbia River plume or bathymetric features such as Hecate Bank. See [Chemistry](#), [Plankton](#) and/or [Bethos](#) chapters for more information.
- Information on changes in wave heights, wave direction or incident angle. This information is important to estimate changes in littoral processes.

15.5 LIST OF LITERATURE CITED—PHYSICAL OCEANOGRAPHY

Barthelmie, R.J. and S.C. Pryor. 2006. Challenges in predicting power output from offshore wind farms. *Journal of Energy Engineering*, U.S. Dept. of Defense, ASCE 132(3):91-103.

Barthelmie, R.J., S.T. Frandsen, M.N. Nielsen, S.C. Pryor, P.E. Rethore and H.E. Jørgensen. 2007. Modelling and measurements of power losses and turbulence intensity in wind turbine wakes at Middelgrunden offshore wind farm. *Wind Energy* 10 (6): 517-528.

Bedard, R., G. Hagerman, M. Previsic, O. Siddiqui, R. Thresher and B. Ram. 2005. Final summary report: Project definition study—Offshore wave power feasibility demonstration project. E21 EPRI Global WP.

Behrens, D., J. Castle, G. Crawford, R.N. Gaddam, S.C. Hackett, J. Largier, D.P. Lohse, K.L. Mills, P.A. Nelson, P.T. Raimondi, M. Robart, W.J. Sydeman, S.A. Thompson and S. Woo. 2008. Developing wave energy in Coastal California: Potential socio-economic and environmental effects. Prepared for: California Energy Commission.

Bruun, P. and F. Gerritsen. 1960. Stability of coastal inlets. North Holland Publishing, Amsterdam.

Dean, R.G. 1973. Heuristic models of sand transport in the Surf Zone. *Proceedings of the Conference of Engineering Dynamics in the Surf Zone*. Sydney. Pp 208-214.

- Hapke, C.J., D. Reid, B.M. Richmond, P. Ruggiero, and J. List. 2006. National assessment of shoreline change part 3: Historical shoreline change and associated land loss along sandy shorelines along the California Coast. U.S. Dept. of Interior, USGS Open File Report 2006-1219.
- Komar, P.D. 1996. Tidal-inlet processes and morphology related to the transport of sediments. *Journal of Coastal Research* (Special Issue 23):23-45.
- Komar, P.D. 1998. *Beach processes and sedimentation*. Prentice-Hall, New Jersey.
- Large, W.G. and S. Pond. 1981. Open ocean momentum flux measurements in moderate to strong winds. *Journal of Physical Oceanography* 11(3):324-336.
- Largier, John. 2008. The potential impact of WEC development on nearshore and shoreline environments through a reduction in nearshore wave energy. California Energy Commission, PIER Energy-Related Environmental Research Program and California Ocean Protection Council.
- O'Rourke, J.C. and P.H. Leblond. 1972. Longshore currents in a Semicircular Bay. *Journal of Geophysical Research* 77:444-452.
- Penney, W.G. and A.T. Price. 1952. Part I. The diffraction theory of sea waves and the shelter afforded by breakwaters. *Philosophical Transactions of the Royal Society of London. Series A, Mathematical and Physical Sciences* 244(882):236-253.
- Ranasinghe, R. and C. Pattiaratchi. 2003. The seasonal closure of tidal inlets: causes and effects. *Coastal Engineering* 45:601-627.

16. GEOLOGICAL OCEANOGRAPHY

Renewable energy structures are expected to have little effect on most major geologic features of the continental shelf and slope, as the footprint size of the structures and foundations will be very small in comparison to geological features and will not provide forces large enough to disturb continental plates. The offshore areas of the Northern Study Area are susceptible to undersea tectonic activity at the plate margins (Thurman 1994). While offshore wind and hydrokinetic installations will have no effect on the occurrence or magnitude of plate slippage or resulting tsunamis, these devices may be affected by tectonic activity, resulting in equipment being torn from moorings and washed ashore, causing nearshore habitat damage (USDOJ, MMS 2007).

Offshore wind platforms and wave buoys, and their associated cables and anchors, may disrupt sediment transport in the nearfield, potentially causing changes in sediment deposition, erosion, and mass wasting (USDOJ, MMS 2007). Heavy rainfall along the Northern California coast caused by orographic lift over the coastal ranges, coupled with tectonic activity, weak bedrock, and oversteepened slopes, produces high rates of mass wasting and erosion, and high sediment bedload. Sediment offshore of the Northern California coast is primarily derived from fluvial input and is funneled across the continental shelf by submarine tectonic folds and submarine canyons. The heads of submarine canyons and gullies are affected by fluid flows due to fluid expulsion of interstitial water, rilling and aquifer flow, or the sediments may undergo slumping (Greene et al. 2002). Pockmarks and rills are less common in water depths less than 300 m. Offshore wind and hydrokinetic installations may disrupt sediment transport, possibly triggering mass wasting in upper parts of submarine canyons or gullies. However, the gullies along Northern California appear to be inactive, and are being filled and draped by turbidity flows of sediments from the Eel and Mad Rivers (Burger et al. 2003; Goff et al. 1996).

Sedimentation rates along the Outer Continental Shelf of the more humid coastal areas of northern Oregon and Washington are higher than along similar environments offshore of southern Oregon. Large mass-wasting events appear to be more common in the southern portions of the Northern Study Area, perhaps related to steeper slopes and more mobile material from the influence of large river fluxes such as the Columbia and Eel Rivers. These large mass-wasting events appear to be triggered by seismic activity rather than wave activity (MacAdoo and Watts 2004).

Offshore of Northern California, active mobilization of sediment extends to at least 60 m water depth (Ogston and Stenberg 1999). Seasonal long-period waves off Oregon mobilize sediment to a depth of 200 m (Burger et al. 2002). Sediment on the continental shelf is generally thin and relict away from river sources. Wave and offshore wind floating platforms and wave buoys have anchors and cables temporarily tethered to the sea floor (Musial 2008; USDOJ, MMS 2007; USDOE 2009) that can scour unconsolidated and semiconsolidated sediment (USDOD, Army Corps of Engineers 2006). Areas of the continental shelf that are near river inputs or are in seasonally defined current paths may be most susceptible to scour, potentially changing soft-bottom habitat to hard bottom, and affecting benthic communities.

16.1 SUMMARY AND DATA GAPS

Renewable energy structures are expected to have little effect on most major geologic features of the continental shelf and slope as the footprint size of the structures and foundations will be very small in comparison to geological features and will not provide forces large enough to disturb continental plates. While offshore wind and hydrokinetic installations will have no effect on the occurrence or magnitude of plate slippage or resulting tsunamis, these devices may be affected by tectonic activity in the Northern Study Area, resulting in equipment being torn from moorings and washed ashore, causing nearshore habitat damage. Offshore wind platforms and wave buoys, and their associated cables and anchors may disrupt sediment transport in the nearfield, potentially causing changes in sediment deposition, erosion, and mass wasting offshore in the Northern Study Area.

Additional data are needed to determine the degree to which tectonic activity may affect offshore wind and wave installations in the Northern Study Area. Estimates of potential secondary biological injury could be made from other infrastructure examples. In addition, data are needed on sedimentation patterns that may be disrupted by the presence of platforms, cables, and anchors.

16.2 LIST OF LITERATURE CITED—GEOLOGICAL OCEANOGRAPHY

- Burger, Robert L., Craig S. Fulthorpe and James A. Austin. 2003. Effects of triple junction migration and glacioeustatic cyclicity on evolution of upper slope morphologies, offshore Eel River Basin, Northern California. *Marine Geology* 199 (3-4): 307-336.
- Burger, Robert L., Craig S. Fulthorpe, James A. Austin and Sean P. S. Gulick. 2002. Lower Pleistocene to present structural deformation and sequence stratigraphy of the continental shelf, offshore Eel River Basin, Northern California. *Marine Geology* 185 (3-4): 249-281.
- Greene, H.G., N. Maher and C. Paull. 2002. Physiography of the Monterey Bay region and implications about continental margin development. *Marine Geology* 181 55-82.
- Goff, J.A., L.A. Mayer, J. Hughes-Clarke and L.F. Pratson. 1996. Swath Mapping on the Continental Shelf and Slope: The Eel River basin, Northern California. *Oceanography* 9 (3): 178-182.
- Macadoo, B.G. and P. Watts. 2004. Tsunami hazard from submarine landslides on the Oregon continental slope. *Marine Geology* 203: 235-245.
- Musial, W. 2008. Status of Wave and Tidal Power Technologies for the United States. Technical Report. NREL/TP-500-43240.
- Ogston, A.S. and R.W. Stenberg. 1999. Sediment-transport events on the Northern California continental shelf. *Marine Geology* 154:69-82.
- Thurman, H.V. 1994. *Introductory Oceanography*. 3rd edition. New York: Macmillan Publishing Company. 575 pp.

- U.S. Dept. of Defense, Army Corps of Engineers. 2006. Cape Wind Energy Project, Draft Environmental Impact Statement. <http://www.nae.usace.army.mil/projects/ma/ccwf/deis.htm>
- U.S. Dept. of Energy. 2009. Potential Environmental Effects of Marine and Hydrokinetic Energy Technologies. Report to Congress prepared in response to the Energy Independence and Security Act of 2007, Section 633(b). June, 2009. 88 p. + appendices.
- U.S. Dept. of Interior, Minerals Management Service (MMS). 2007. Programmatic Environmental Impact Statement for Alternative Energy Development and Production and Alternate Use of Facilities on the Outer Continental Shelf. MMS OCS EIS/EA 2007-046.

17. CHEMICAL AND GEOCHEMICAL OCEANOGRAPHY

The Northern Study Area comprises a dynamic coastal and shelf area, with several large embayments including Grays Harbor, Willapa Bay and San Francisco Bay, numerous smaller river mouths and bays along the Oregon and Northern California coasts, and the influence of the Columbia River plume. Effects on the chemistry and geochemistry of the region by pre-siting studies, deployment, operation, maintenance, and decommissioning of renewable energy facility in the Northern Study Area will depend on the specific location of the installations. As discussed at length by a group of experts in 2008, the Northern Study Area's sensitivities potentially include effects of energy removal on circulation patterns, changes in sediment transport patterns due to interception of wave trains and coastal currents by platforms and mooring structures, and the potential for leaching of chemicals, coatings and petroleum products from the structures and supply ships (Boehlert et al. 2008).

17.1 EFFECTS OF ENERGY REMOVAL

Chemical effects are of low concern for ocean waves and ocean currents, but of concern for all biological receptors (Boehlert et al. 2008; Wilson et al. 2007). It is not known how many devices or at what density marine hydrokinetic installations might be deployed before adverse biological effects might be felt, due to chemical contamination. Similarly, it is not known how wide-spread effects of chemical contamination might be (Boehlert et al. 2008). Marine hydrokinetic energy and offshore wind structures and devices are expected to change near-field hydrodynamics, altering physiochemical parameters such as salinity, mixing, dissolved oxygen, and sediment resuspension, but only modeling results are available currently (Venugopal and Smith 2007) rather than observations. (See [Chapter 15 for Physical Impacts](#), and Boehlert et al. 2008 Appendix 5 for a review of physical effects by Komar et al.) The extent of sediment resuspension will depend on the seabed structure, the location, and the scale of arrays. Shields et al. (2009) concluded some resuspension of sediment will occur, resulting in local increases in turbidity and potentially some geochemical consequences; however, more significantly, sedimentation patterns will be altered by the energy removal from the system. The water depth at which renewable energy installations will be deployed in the Northern Study Area ensures that the footprint of the anchors will be small. The small mooring footprint is likely to disturb bottom sediments minimally, resuspending sediments into the water column. The sediment resuspension at depth is unlikely to have an effect on the water column nutrients, dissolved oxygen, carbonate system, dissolved gases, or other naturally occurring chemicals (Keil et al. 2004). If there were significant contamination of offshore sediments by metals, toxic organics, or radionuclides, this level of resuspension might be of concern. However, as shown in [chapter 3](#) (Chemistry of NSA), there is very little contamination of OCS sediments in the Northern Study Area, with the exception of a designated weapons dumping site off Northern California (Bull 2005; Historical Research and Response Team 2001).

In addition, the removal of energy from the system may increase water column stratification by slowing mixing processes and altering the ventilation of deepwater or the replenishment of dissolved oxygen, which would adversely impact marine life and fisheries (Komar et al. in Appendix 5 of Boehlert et al. 2008). On the continental shelf, the subtle vertical mixing near the bottom observed by Hales et al. (2005) that leads to the usually high productivity of the more

northern waters of the Northern Study Area by supplying more iron nitrate could be monitored for changes.

17.2 CHEMICAL CONTAMINANTS

Boehlert et al. (2008) compiled a synopsis of the potential chemical impacts from marine hydrokinetic devices specific to the Northern Study Area. Impacts of chemicals leaching or spilled from renewable energy devices and installations must be viewed in the context of the water chemistry of the region, as reviewed by Boehlert et al. (2008). This study divided potential chemical impacts into unintentional releases from leaks or spills and expected releases from antifouling paints or sacrificial anodes. Oil spills or hydraulic fluid or fuel leaks from increased vessel traffic have a low probability of occurrence, but potentially a high impact. Antifouling and anticorrosion devices are known to release significant concentrations of dissolved metals (e.g., copper or zinc). Boehlert et al. (2008) suggested such releases could be considered continually occurring. However, the magnitude of any impacts is uncertain and will vary based on site-specific biogeochemical factors. The range of chemical impacts will depend on the ultimate fate of the chemicals as a function of their chemical specific geochemical properties, which will drive the chemical speciation and transport or uptake by organisms. Additionally, select chemicals may persist in the environment, accumulate in biological tissue, and be transferred among trophic levels. Finally, if a device breaks free and washes ashore, the location of any chemical impacts would shift from offshore habitat to shoreline habitat.

The anticipated chemical releases resulting from the placement of wave and offshore wind devices in seawater include copper from antifouling paint, organics leaching from epoxy-based paints, and zinc from sacrificial anodes. There are no studies on leaching from paints and coatings in the Northern Study Area; literature values on the mass of each chemical released under select environmental conditions could be used as guidance. However, the leaching rates should be evaluated for specific environmental conditions, length of deployment, and other factors. Valkirs et al. (2003) reported a copper leaching rate of $3.9 \mu\text{g}/\text{cm}^2/\text{day}$ on paint formulas used on Navy vessels in San Diego, CA. It is important to note that the leach rates must be specific to the depth, temperature, and redox conditions present at the installation. Creclius et al. (2007) noted the release of trace metals associated with barite drilling fluid was dramatically increased under anoxic sedimentary conditions, as the barium sulfate was reduced and associated metals released into the pore water. While this study was specifically done to assess the chemical impacts of oil drilling fluids on marine sediments and may not be applicable for marine hydrokinetic structures, it highlights the importance of assessing the mobility of contaminants under the conditions present on the continental shelf and not assuming they will be similar to what is seen in nearshore environments. Much literature (Borch et al. 2010, Eggleton and Thomas 2004) supports the varying mobility of chemical contaminants under different temperature, pressure, and redox conditions.

Important biological responses can occur in nontarget species at sublethal exposures to chemical contaminants in the Northern Study Area (e.g. Katranitsas et al. 2003; Ahsanuliah and Williams 1991; Drummond et al. 1973). Many chemicals, including dissolved metals such as copper and zinc, are known to have sublethal effects on marine species' sensory systems, growth, and behavior (Bonnard et al. 2009; Lang et al. 1980). Chemicals from wave and offshore wind

installations may produce sublethal effects, either as direct effects of chemical exposures for target species or indirect effects. For example, if a species is not directly affected by a chemical, its prey species may be, impacting the predator species by reduced prey availability.

Because the structures or devices will act as artificial reefs, it is important to understand the chemical implications of the resulting change in organic matter conditions. Although there are no studies specific to the Northern Study Area, Falcão et al. (2007) examined the effects of artificial reef (AR) structures off the southern coast of Portugal on biogeochemical processes and nutrient cycling. Results of the two-year study showed that: (1) there was a significant exponential fit between organic carbon and chlorophyll *a* in reef sediment, suggesting an increase of benthic productivity; (2) organic carbon and nitrogen content in settled particles within the AR environment was about four times higher two years after reef deployment; and (3) nutrients and chlorophyll *a* in the water column were higher at the AR than the control site. Two years after AR deployment, dissolved organic and inorganic compounds in near-bottom water were 30 to 60 percent higher, emphasizing benthic remineralization processes at the AR's organically rich sediment. These marked chemical changes in the ecosystem will result in changes in contaminant mobilization and can also result in conversion of some naturally occurring metals (either in the sediments or in the benthos congregating at the AR) to more toxic and bioaccumulative forms (e.g., conversion of mercury to methylmercury).

Monitoring and laboratory mesocosm studies will be critical to assessing the direct and indirect impacts of chemicals, and should be tailored to the chemical and geochemical conditions of the Northern Study Area. However, understanding the physiochemical changes to the ecosystem (e.g. reduced energy for sediment transport) requires a more complex modeling-based program. These programs will need to identify sensitive areas not only as a function of biota and habitat, but also with respect to water-column stratification or areas anticipated to be in the lower energy shadow of these structures (long-range sediment transport impacts). Boehlert et al. (2008) proposed baseline monitoring before the installation of a device to include an analysis of the area of influence, as well as the physical location of the structure. That study concluded that monitoring studies need to consider that while the impact of a single device may be subtle and hard to detect, the cumulative impact of dozens to hundreds of devices may be appreciable.

The NOAA National Status and Trends Mussel Watch Program monitors and reports on concentrations and trends in approximately 140 contaminant analytes in the coastal U.S. and Great Lakes. The 2008 Report "Mussel Watch: An Assessment of Two Decades of Contaminant Monitoring in the Nation's Coastal Zone" (Kimbrough et al. 2008a) covers 1986-2005. Of the 17 metals and metalloids, the most accurate extensive data set is available for Arsenic, Cadmium, Copper, Lead, Mercury, Nickel, Tin and Zinc. Of the organic contaminants, 65 PAHs are quantified. PBDEs are being studied using archived tissue and current sampling (Kimbrough et al. 2008b). Within the Northern Study Area there are 27 monitoring sites that vary from bays and estuaries to open coast.

17.3 EFFECTS OF INCREASED VESSEL TRAFFIC

The potential negative effects of increased vessel traffic in the Northern Study Area include: a higher risk of discharges and spills, leaching of bottom paints ([discussed in section 17.2](#)), and increased atmospheric pollution from ship exhausts. Repeated routine discharges from commercial vessels are likely to cause more adverse effects than potential but low frequency spills. Bottom paints are used on all seagoing vessels, including commercial vessels. The effects of toxic chemicals leaching from the hulls of ships may pose a minor to moderate impact in enclosed areas. Ship exhaust fumes from engines powered by fossil fuels will release a variety of chemicals into the atmosphere. Exhaust fumes from fossil fuel engines significantly reduce air quality.

Discharges from commercial vessels generally fall under the categories of bilge (water in the boat), fuel, lubricating and hydraulic fluids, cleaning agents, paint, and human waste. Bilge water has potential to be the primary pollutant from increased boat traffic. Bilge contains not just water but also chemicals from minor spills or leaks originating from engines or other machinery and general operations. This can include anything liquid from the discharge categories. The routine discharge from a single vessel will cause negligible impacts. However, the cumulative effects over time could moderately impact the environment. There is an information need to quantify the cumulative effects.

Fuel is of concern because of the volume that is carried on vessels, measured in tens of tons for larger vessels. The vast majority of spills are small (less than 7 tons); larger spills have been occurring with decreasing frequency since the 1970s (Talley 2003) a testament to increasing safety standards. Lubricating and hydraulic fluids are typically oils with function-specific physical characteristics. They are not typically carried in large quantities unless they are being transported for distribution. Ocean vessel machinery may leak small amounts of oil from hydraulic or lubricating systems. These discharges will frequently make their way to the ocean before the crew is aware of them. The effect of these discharges is likely negligible to minimal.

Cleaning agents generally are soap and solvents. Soaps for use on ocean-going vessels tend to be formulated to be biodegradable and pose little threat to the marine environment. Solvents can also be formulated to be biodegradable, such as orange-based products. However, biodegradable solvents are not always effective for some applications and petroleum-based solvents are often necessary. Even in the event of a small discharge of these solvents, the impacts would be small.

Paints on vessels may include antifouling paint, interior paint and exterior paint, typically for metal surfaces and for maintenance purposes only. The amounts on vessels would be very small and their impacts, if released, would be negligible based on volume.

Seagoing vessels are a significant source of NO_x, contributing more than 10% of the global tropospheric budget; surface NO_x concentrations in heavily traversed ocean regions are 100 times higher than background (Lawrence et al. 1999). The authors modeled this NO_x source and found it significantly increased surface ozone and hydroxyl radicals. A side effect of this higher ozone and OH was a predicted decrease in methane concentrations.

Because shipping vessels remain in the shipping lanes which tend to be in international waters (the obvious exception being when approaching port), accidental or intentional oil spills will be at a distance of tens of kilometers offshore. Further offshore, the environmental impact generally will be smaller than for a similar spill closer to shore where water is shallower and there is less potential for evaporation, dispersion and dilution. Dilution is important particularly for the more toxic, volatile and soluble components (Engelhardt 1987). The processes governing all but massive oil spills in the shipping lanes will be similar to those governing oil from natural seeps. In general, currents are largely along shore, thus it is the seabreeze that pushes oil toward shore. As a result, oil will tend to move toward shore in the afternoons, and offshore at night (Del Sontro et al. 2007). Moreover, in general, because of the distance to shipping lanes (depending on the spill size) the more toxic and volatile components will be reduced, potentially significantly, before the oil arrives near shore. This does not apply for coastal enclosed waterways and harbor spills such as the Cosco Busan Spill in November 2007 in San Francisco Bay.

Because of the general shift in recent years toward heavier crude oils, increased vessel transport will increase the risk of accidental releases of dense oil that may sink to the bottom or break into oil droplets that rise very slowly (NRC 1999). While understanding of the processes governing surface oil slicks have been studied for decades, research on the weathering and transport processes of sinking oil are largely unstudied, particularly for oils denser than seawater. Submerged oil may resurface and/or wash upon shorelines, e.g., the Motor Vessel Braer disaster 1993 (Thorpe 1995) or remain submerged as in the Tanker Barge DBL-152 offshore of Louisiana in 2005 (Beegle-Krause et al. 2006). Some literature has investigated the surface submerged droplet size distributions, reported to be primarily between 1 and 70- μm at sea with a mean diameter of 20 μm (Li and Garrett 1998). In a flume tank, Delvigne and Sweeney (1988), found a larger mean diameter of 100 -170 μm with a dependency on viscosity. Oil “puddles” on the sea bottom from the DBL-152 were centimeters thick.

17.4 SUMMARY AND DATA GAPS

The chemistry and geochemistry of the waters of the Northern Study Area may be affected by the removal of energy, causing changes in circulation, leading to changes in dissolved oxygen levels, salinity, and other water quality parameters, and perhaps changes in the marine food web.

Offshore wind platforms, wave buoys and mooring structures may create changes in sediment transport patterns due to interception of wave trains and coastal currents, leading to changes in patterns of sediment settlement. As there is relatively little contamination of coastal and offshore sediments by toxic material in the Northern Study Area, there is unlikely to be significant resuspension and redistribution of contaminants.

Renewable energy installations and operations, as well as supply ships, have the potential for leaching of chemicals, coatings and petroleum products.

Additional data are needed to better understand the correlation between energy removal from the system and any changes in dissolved oxygen, nutrients and other water quality parameters. Monitoring for alterations in nutrient supply and productivity changes is important, and areas of

the Northern Study Area have unusually high productivity (Hickey and Banas 2008). Changing patterns of sediment transport also require further information to determine whether the redistribution of sediment types has an effect on other parameters, including those affecting marine organisms. Data are needed to understand the effects and distribution of anti-fouling paints and coatings from renewable energy installations, and to examine the potential for deploying new paints and coatings that are effective against fouling organisms and harsh ocean conditions, while being less toxic to organisms.

17.5 LIST OF LITERATURE CITED—CHEMICAL AND GEOCHEMICAL OCEANOGRAPHY

- Ahsanuliah, M., and A.R. Williams. 1991. Sublethal effects and bioaccumulation of cadmium, chromium, copper and zinc in the marine amphipod *Allorchestes compressa*. *Marine Biology* 108(1):59-65.
- Beegle-Krause, C.J., C. Barker, G. Watabayashi and W. Lehr. 2006. Long-Term Transport of Oil from the T/B DBL-152: Lessons Learned for Oils Heavier than Seawater. AMOP 2006 Proceedings, Vancouver B.C., Canada, June 6-8, 2006. Ottawa, Ont: Environment Canada.
- Boehlert, G.W., G.R. McMurray and C.E. Tortorici (eds). 2008. Ecological effects of wave energy in the Pacific Northwest. U.S. Dept. Commerce, NOAA Tech. Memo. NMFS-F/SPO-92, 174 pp.
- Bonnard, M., M. Romeo and C. Amiard-Triquet. 2009. Effects of Copper on the Burrowing Behavior of Estuarine and Coastal Invertebrates, the Polychaete *Nereis diversicolor* and the Bivalve *Scrobicularis plana*. *Human And Ecological Risk Assessment* 15(1)11-26.
- Borch, T.K. Campbell and R. Kretzschmar. 2010. How electron flow controls contaminant dynamics. *Environmental Science and Technology* 44(1):3-6.
- Bull, J.M. R. 2005. Special Report, Part 1: The Deadliness Below. The Daily Press, <http://www.dailypress.com>. April 29.
- Creclius, E., J. Trefry, J. McKinley, B. Lasorsa and R. Trocine. 2007. Study of barite solubility and the release of trace components to the marine environment. U.S. Dept. of the Interior, Minerals Management Service, Gulf of Mexico OCS Region, New Orleans, LA. OC5 Study MMS 2007-061. 176 pp.
- Del Sontro, T., I. Leifer, B.P. Luyendyk and B.R. Broitman. 2007. Beach tar accumulation, transport mechanisms, and sources of variability at Coal Oil Point, California. *Marine Pollution Bulletin* 54 (9): 1461-1471.
- Delvigne, G.L. and C.E. Sweeney. 1988. Natural dispersions of oil. *Oil and Chemical Pollution* 4 (4): 281-310.

- Drummond, R.A., W.A. Spoor and G.F. Olson. 1973. Some short-term indicators of sublethal effects of copper on brook trout, *Salvelinus fontinalis*. Journal of the Fisheries Research Board of Canada 30: 698-701.
- Eggleton, J. and K.V. Thomas. 2004. A review of factors affecting the release and bioavailability of contaminants during sediment disturbance events. Environment International 30(7): 973-980
- Engelhardt, F.R. 1987. Assessment of the vulnerability of marine mammals to oil pollution. In: J. Kuiper and W.J.V. d. Brink. Fate and Effects of Oil in Marine Ecosystems, Dordrecht, Lancaster, Boston. Martin Nijhoff Publishers, 101-115 pp.
- Falcão, M., M.N. Santosa, M. Vicentea and C.C. Monteiroa. 2007. Biogeochemical processes and nutrient cycling within an artificial reef off Southern Portugal. Marine Environmental Research 63 (5): 429-444.
- Hales, B., J.N. Moum, P. Covert and A. Perlin. 2005. Irreversible nitrate fluxes due to turbulent mixing in a coastal upwelling system. Journal of Geophysical Research, 110, C10S11, doi:10.1029/2004JC002685.
- Hickey, B.M. and N.S. Banas. 2008. Why is the Northern End of the California Current System So Productive? Oceanography 21(4):90-107.
- Historical Research and Response Team. 2001. Offshore disposal of chemical agents and weapons conducted by the United States. U.S. Dept. of Defense, Army Research Development and Engineering Command. Historical Research Database no. 26.
- Katranitsas, A., J. Castritsi-Catharios and G. Persoone. 2003. The effects of a copper-based antifouling paint on mortality and enzymatic activity of a non-target marine organism. Marine Pollution Bulletin 46(11): 1491-1492.
- Keil, R.G., A.F. Dickens, T. Arnarson, B.L. Nunn and A.H. Devol. 2004. What is the oxygen exposure time of laterally transported organic matter along the Washington margin? Marine Chemistry 92 (1-4): 157-165.
- Kimbrough, K.L., W.E. Johnson, G.G. Lauenstein, J.D. Christensen and D.A. Apeti. 2008a. An Assessment of Two Decades of Contaminant Monitoring in the Nation's Coastal Zone. Silver Spring, MD. U.S. Dept. of Commerce, NOAA Technical Memorandum NOS NCCOS 74. 105 pp.
- Kimbrough, K.L., W.E. Johnson, G.G. Lauenstein, J.D. Christensen and D.A. Apeti. 2008b. An Assessment of Polybrominated Diphenyl Ethers (PBDEs) in Sediments and Bivalves of the U.S. Coastal Zone. Silver Spring, MD. U.S. Dept of Commerce, NOAA Technical Memorandum NOS NCCOS 78. 76 pp.

- Lang, W.H., R.B. Forward, D.C. Miller and M. Marcy. 1980. Acute toxicity and sublethal behavioral effects of copper on barnacle nauplii (*Balanus improvisus*). *Marine Biology* 58(2):139-145.
- Lawrence, M.G., and P.J. Crutzen. 1999. Influence of NO_x emissions from ships on tropospheric photochemistry and climate. *Nature* 402: 167-170.
- Li, M. and C. Garrett. 1998. The relationship between oil droplet size and upper ocean turbulence. *Marine Pollution Bulletin* 36 (12): 961-971.
- NRC Marine Board. 1999. Spills of non-floating oils: risk and response, report prepared by Committee on Marine Transportation of Heavy Oils, Marine Board, Commission on Engineering and Technical Systems, National Research Council, National Academy Press, Washington, DC, M.L. Spaulding, committee chair, 75 p.
- Pelc, R. and R.M. Fujita. 2002. Renewable energy from the ocean. *Marine Policy* 26 (6): 471-479.
- Shields, M.A., L.J. Dillon, D.K. Woolf and A.T. Ford. 2009. Strategic priorities for assessing ecological impacts of marine renewable energy devices in the Pentland Firth (Scotland, UK). *Marine Policy* 33: 635-642.
- Talley, W.K. 2003. Environmental Impacts of Shipping. In: D.A. Hensher and K.J. Button. *Handbook of Transport and the Environment*. Elsevier. 279-291pp.
- Thorpe, S.A. 1995. Vertical dispersion of oil droplets in strong winds; the Braer oil spill. *Marine Pollution Bulletin* 30 (11): 756-758.
- Valkirs, A.O., P.F. Seligman, E. Haslbeck and J.S. Caso. 2003. Measurement of copper release rates from antifouling paint under laboratory and in situ conditions: implications for loading estimation to marine water bodies. *Marine Pollution Bulletin* 46 (6): 763-779.
- Venugopal, V. and G.H. Smith. 2007. The effect of wave period filtering on wave power extraction and device tuning. *Ocean Engineering* 34 (8-9): 1120-1137, doi:10.1016/j.oceaneng.2006.08.003.
- Wilson, B., R.S. Batty, F. Daunt and C. Carter. 2007. Report to the Scottish Executive. Scottish Association for Marine Science, Oban, Scotland. PA25 1QA. 110 p. (2007). *Collision Risks Between Marine Renewable Energy Devices and Mammals, Fish and Diving Birds*. S.A.F.M. Science. Oban, Scotland: 110 pp.

18. PHYTOPLANKTON, ZOOPLANKTON, AND PELAGIC INVERTEBRATES

18.1 EFFECTS OF ENERGY REMOVAL

There are few data available to determine the effects of renewable energy facility siting, construction, operation, or maintenance on plankton and pelagic invertebrates (Gill 2005), and none specific to the Northern Study Area. While some potential effects can be extrapolated from offshore oil and gas development impacts, the installation and operation of marine hydrokinetic and offshore wind farms will differ greatly from the installation and operation of offshore drilling platforms.

One of the greatest concerns in the installation and operation of marine hydrokinetic devices is the potential changes in the integrity of the water column due to the long-term removal of energy (Boehlert et al. 2008). In enclosed areas, removal of significant amounts of energy may alter water circulation patterns and sediment transport, resulting in deterioration of water quality and sedimentation patterns, and ultimately causing severe changes in the growth and productivity of phytoplankton and subsequent levels of the food chain (Wilson et al. 2007). In the open waters of the Northern Study Area, these large-scale breakdowns are less likely because of the large size of the coastal ocean system; however, the effects of removal of significant energy must be considered, particularly for wave generators, when buildouts to industrial-scale farms are planned. Offshore wind farms are unlikely to have effects on water column organisms (DONG Energy 2006).

The River Influence in Shelf Ecosystem (RISE) program investigated biophysical processes in the vicinity of the Columbia River plume (see Hickey et al. 2010 synthesis). Irreversible vertical mixing near the bottom moves nitrate and iron into the photic zone where it can be used for productivity. Whether groups of anchors could alter this mixing and therefore the timing and or amount of productivity is unknown.

18.2 WATER ENTRAINMENT

Water entrainment through marine hydrokinetic devices may affect plankton and small pelagic invertebrates that pass through the devices; however, in most cases turbines and wave attenuators are coarse in scale (as compared to most of these organisms), allowing the organisms to pass through unscathed. Cada's (1990) review indicates mortality to ichthyoplankton would be less than five percent due to blade strike. Larger pelagic invertebrates, like giant squid and large crustaceans, may be affected; however, these pelagic animals are generally good swimmers and are likely to be alerted by the vibration and water movement surrounding operational devices and actively avoid them (Shields et al. 2009). Data are needed on whether blade strike injuries occur to jellies (Boehlert et al. 2008); jellies are made up of large numbers of colonial cells, allowing most of the organism to survive and regrow. Offshore wind platforms will not entrain plankton or pelagic organisms.

Increased vessel traffic will also increase the amount of water entrained around renewable energy developments. Engine cooling water will likely be the major use for seawater. Plankton

entrained in this manner can be killed (USDOJ, MMS 2007). However, the size of the plankton communities in the area are not likely to be significantly altered because of this loss.

18.3 CHEMICAL CONTAMINANTS

Leakage of paints, antifouling coatings, and lubricating oil from marine hydrokinetic and offshore wind devices may have a deleterious effect on phytoplankton and zooplankton, particularly larval species of benthic organisms (Wilson et al. 2007). Linbo et al. (2006) demonstrated that dissolved copper triggered a dose-dependent loss of neurons in identified lateral line neuromasts at concentrations ≥ 20 $\mu\text{g/L}$ in larval zebrafish, which could lead to decreased survival due to interference with mechano-sensory-mediated behaviors. Oceanic and transition zone species are likely to be more sensitive than the hardier coastal species. Similarly, pelagic invertebrates may be adversely affected by chemicals from installations and operations. However, impacts due to toxicity are not likely to occur at offshore developments because leaching chemicals will be quickly diluted. An ecological risk assessment of leaching biocides found little risk in the coastal and offshore waters around Europe (Hall and Anderson 1999).

18.4 NOISE AND ELECTROMAGNETIC FIELDS

Plankton are generally not considered to be sensitive to noise or vibration, although there has been very little investigation into this area. Therefore increases in vessel traffic, as well as noise and vibrations due to installation and operations, are not likely to be significant factors in changing planktonic regimes. There is little known about possible effects on pelagic invertebrates; some laboratory studies have shown that octopus are attuned to noise and vibration, although it is not known if other cephalopods including squid are similarly sensitive.

Little is known about the potential effects of electromagnetic fields (EMF) on plankton or pelagic invertebrates (Gill 2005). EMF extends short distances in seawater, with the electric field dissipating within a few centimeters of the device and the magnetic field reaching somewhat further. The few studies on EMF in plankton and pelagic invertebrates indicate that crustaceans and cephalopods can sense electrical and magnetic fields, but it is not known how they interact with those fields, or what intensity is likely to interrupt their behavior.

18.5 SUMMARY AND DATA GAPS

Impacts on plankton from renewable energy installations and operations in the Northern Study Area are likely to be minor. Changes in energy within the system could potentially have impacts on nutrient availability and water circulation that will affect growth of phytoplankton and their prey. Larger pelagic organisms could potentially be entrained into marine hydrokinetic devices and harmed, although most populations are unlikely to be affected.

Additional data are needed to determine whether changes in energy within the system caused by energy extraction will affect plankton populations and productivity.

18.6 LIST OF LITERATURE CITED—PLANKTON, ZOOPLANKTON, AND PELAGIC INVERTEBRATES

- Boehlert, G.W, G.R. McMurray and C.E. Tortorici (editors). 2008. Ecological effects of wave energy in the Pacific Northwest. U.S. Dept. Commerce, NOAA Tech. Memo. NMFS-F/SPO-92, 174 p.
- Cada, G.F. 1990 . A Review of Studies Relating to the Effects of Propeller-Type Turbine Passage on Fish Early Life Stages. North American Journal of Fisheries Management 10:418-426, doi:10.1577/1548-8675(1990)010<0418:AROSRT>2.3.CO;2
- DONG Energy, Vattenfall, The Danish Energy Authority and The Danish Forest and Nature Agency. 2006. Key Environmental Issues Danish Offshore Wind. Danish Energy Authority. 144 pp. Internet website: <http://ens.netboghandel.dk>. Accessed July 13, 2009.
- Hall, L.W. and R.D. Anderson. 1999. A deterministic ecological risk assessment for copper in European saltwater environments. Marine Pollution Bulletin 38(3):207-218.
- Hickey, B.M., R.M. Kudela, J.D. Nash, K.W. Bruland, W.T. Peterson, P. MacCready, E.J. Lessard, D.A. Jay, N.S. Banas, A.M. Baptista, E.P. Dever, P.M. Kosro, L.K. Kilcher, A.R. Horner-Devine, E.D. Zaron, R.M. McCabe, J.O. Peterson, P.M. Orton, J. Pan and M.C. Lohan. 2010. Journal of Geophysical Research 115, C00B17, doi:10.1029/2009JC005452.
- Gill, A.B. 2005. Offshore renewable energy: ecological implications of generating electricity in the coastal zone. Journal of Applied Ecology 42 605-615.
- Linbo, T.L., C.M. Stehr, J.P. Incardona and N.L. Scholtz. 2006. Dissolved Copper Triggers Cell Death in the Peripheral Mechanosensory System of Larval Fish. Environmental Toxicology and Chemistry 25(2) :597–603
- Shields, M.A., L.J. Dillon, D.K. Woolf and A.T. Ford. 2009. Strategic priorities for assessing ecological impacts of marine renewable energy devices in the Pentland Firth (Scotland, UK). Marine Policy 33: 635-642.
- U.S. Dept. of the Interior, Minerals Management Service (MMS). 2007. Programmatic Environmental Impact Statement for Alternative Energy Development and Production and Alternate Use of Facilities on the Outer Continental Shelf, Vol. I: Executive Summary through Chapter 4. U.S. Dept. of the Interior, Minerals Management Service. OCS EIS/EA MMS 2007-046.
- Wilson, B., R.S. Batty, F. Daunt and C. Carter. 2007. Report to the Scottish Executive. Scottish Association for Marine Science, Oban, Scotland. PA25 1QA. 110 p. (2007). Collision Risks Between Marine Renewable Energy Devices and Mammals, Fish and Diving Birds. S. A. f. M. Science. Oban, Scotland: 110 pp.

19. MACROPHYTES

Because macrophytes grow in shallow subtidal and intertidal waters, there will be no direct contact between them and marine hydrokinetic devices or offshore wind parks; however, cables that will bring electricity to shore have the potential to affect these attached plants. Much of the information in this chapter is based on the Boehlert et al. (2008) report, which represents the results of a workshop where 50 U.S. experts from a variety of fields gathered in order to 1) “develop an initial assessment of the potential impacting agents and ecological effects of wave energy development,” and 2) “formulate a general conceptual framework of physical and biological relationships that can be applied to specific wave energy projects.” The results of the workshop should be considered opinions of scientific experts, rather than statements of fact. The scarcity of empirical research on operational alternative energy systems represents a significant data gap in the analysis of likely impacts.

Drifting offshore mats of algae could become trapped by surface wave or wind structures or their mooring lines (Boehlert et al. 2008). Trapped mats could potentially affect local communities by providing extra shelter and food for invertebrates and fish. Pelagic juvenile fish recruited to any anomalous drift mat habitats could have normal migration patterns (i.e., drift trajectories) disrupted, and may suffer increased mortality. Any trapped drift mats could also facilitate kelp growth on the hard structures by shedding kelp propagules. Potentially, trapped drift mats could also add organic matter to the benthos as they decay.

Cable crossings from the marine environment to land-based connections will cross the shallow subtidal and intertidal areas, where there is the potential to cause physical damage to macrophytes, as well as increased scouring of substrates supporting macrophytes.

Marine and hydrokinetic devices and offshore wind platforms use small amounts of petroleum products for lubrication; components will be coated with paints and materials designed to minimize biofouling and to withstand the harsh ocean environment. These materials have the potential to affect macrophytes adversely, particularly vulnerable young growth (Gill 2005; Boehlert et al. 2008). However, leaching of oils, greases, and paints from offshore marine and hydrokinetic devices and wind platforms is unlikely to be a major threat to macrophytes, as marine and hydrokinetic devices and wind parks will be located at considerable distances offshore, allowing for ample dilution before contaminants reach the shoreline.

Cables from offshore devices will be buried in soft sediment wherever possible through a slit-and-cover method (Meggett and Wilson 2003), which effectively shields marine organisms from EMF (Gill et al. 2005). In crossing hard bottom, cables will be placed loosely on the bottom, increasing the possibility of EMF affecting organisms, although it is not known whether EMF affects macrophytes in any significant way.

19.1 SUMMARY AND DATA GAPS

Macrophytes will be affected by alternative energy development only where cables cross the shallow subtidal and intertidal areas where these plants live. Additional impacts could also occur

if alternative energy facilities were to break loose during a storm and wash ashore, damaging macroalgal plants.

The scarcity of empirical research on operational alternative energy systems represents a significant data gap in the analysis of likely impacts.

19.2 LIST OF LITERATURE CITED—MACROPHYTES

Boehlert, G.W., G.R. McMurray and C.E. Tortorici (eds.). 2008. Ecological Effects of Wave Energy in the Pacific Northwest. U.S. Dept. of Commerce, NOAA Tech. Memo. NMFS-F/SPO-92, 174 pp.

Gill, A.B. 2005. Offshore renewable energy: ecological implications of generating electricity in the coastal zone. *Journal of Applied Ecology* 42:605-615.

Gill, A.B., I. Gloyne-Phillips, K.J., Neal and J.A. Kimber. 2005. The potential effects of electromagnetic fields generated by sub-sea power cables associated with offshore wind farm developments on electrically and magnetically sensitive marine organisms—A review. Final Report: COWRIE-Collaborative Offshore Wind Energy Research into the Environment; COWRIE-EM FIELD 2-06-2004.

Meggitt, D.J. and J.V. Wilson. 2003. Requirements for monitoring environmental impact of seafloor cables: Issues and answers. *Oceans 2003.*, September 22-26, 2003. Proceedings, vol. 4: 2058-2062.

20. BENTHOS

20.1 NOISE AND VIBRATIONS

Potential impacts to the benthos from noise and vibrations would occur during installation, operation, and decommissioning of marine hydrokinetic or offshore wind structures. Noise and vibrations would occur during seismic reconnaissance surveys, construction, and operation of the facilities, but no definitive information about potential sound levels is available. Noise created during facility decommissioning could adversely affect the benthos if blasting was required to disassemble structural components. Invertebrates might be injured by the rapid pressure changes resulting from blasting, but Canadian studies on the effects of seismic survey noise on large invertebrates showed no major effects on snow crabs or lobsters, except when animals were very close to the noise source (Bain 2007). Studies of tissue damage have not provided a clear picture of potential effects (Bain 2007) and clearly more research needs to be done. Noise is most likely to affect demersal fish (Govoni et al. 2008). The deep benthic communities of the Northern Study Area that live in the areas directly affected by the installation and operation of renewable energy devices on the OCS are not well characterized; however the dominant epifauna and infauna are small, and generally represent the lower animal phyla ([see section 6](#)). These organisms are not known to be strongly affected by noise or vibration.

20.2 SUSPENDED SEDIMENT AND SEDIMENTATION

Activities during the installation and removal of structures in the Northern Study Area will probably disrupt sediments locally, increasing the suspended sediment content of the water, and to a lesser degree affect the clarity of water and sedimentation at areas distant from the actual facilities. No studies specific to the region have been carried out, however results from other regions can help inform the likely impacts. Additional suspended sediment loads in the water would likely affect some fish and benthic invertebrates through burial of organisms or through clogging of filter feeding apparatus in bivalves like clams (Wilber and Clarke 2001). Most clams can tolerate some level of increased sediment, reducing or shutting down filtering activities during conditions of particularly high suspended sediment (Wilber and Clarke 2001). Suspended sediment could also affect clam larval development, although one such effect is a potential increase in growth rate. Adults may be affected primarily by the disruption of feeding. Epibenthic crustaceans, such as shrimp or crabs, may be affected by increased suspended sediment loads, although severe effects or mortality seem unlikely even at concentrations as high as 10,000 mg/L (Wilber and Clarke 2001). Any effects of increased suspended sediments loads are likely to be localized and temporary.

Structures placed on the sea floor could change circulation patterns, which in turn could affect sediment accumulation. These changes would likely be localized (DONG Energy 2006). However, more extensive effects could result from changes in sediment transport processes. A group of experts in marine ecology focused on potential impacts of renewable energy installations on benthos in the Northern Study Area (Boehlert et al. 2008). The reduction of energy on the lee side of wave energy facilities could cause shoaling and potentially change the texture of the sediment (Boehlert et al. 2008). Such changes in sediment texture contribute to

sediment quality alternation (such as changes in organic content and the size of interstitial spaces) and could affect the composition and health of benthic infaunal communities. There is often a high correlation between sediment texture and infaunal community structure, although the relationship is not necessarily causal (Snelgrove and Butman 1994).

20.3 VESSEL TRAFFIC

The Northern Study Area has substantial vessel traffic from coastal and trans-Pacific shipping; no specific studies from the study area have been found on the effects of vessel noise, anchoring, or other activities. Traffic will increase during the installation and operation of renewable energy structures. However, based on studies from other areas, it is expected that the potential direct effects on the benthos will be small (Boehlert et al. 2008). In open ocean areas, effects would result from anchoring, either from direct contact with the anchor or the sweep of the anchor chain along the bottom. This latter impact would likely affect a large area of the benthos. The disturbance would cause a short-term increase in suspended sediments. Additionally, the chain sweep would disrupt surface-dwelling benthic communities; the extent of the disruption would depend on the type and size of the cable and the amount of drag time on the bottom.

20.4 CHEMICAL LEACHING

Structures placed in the sea to support marine hydrokinetic and offshore wind devices provide new habitat that could be colonized by an assortment of plants and animals. This burgeoning biotic system would reduce the efficiency of many of the structures by increasing drag. Paints and other antifouling coatings are toxic and are designed to inhibit settlement by plants and animals. Direct impacts to the benthos would likely be small unless the antifouling substance flakes off the structure and sinks to the bottom. The effects of this would mostly be restricted to a localized area around the structure, although the cumulative effects of many structures in the Northern Study Area could be considerably larger (Boehlert et al. 2008).

20.5 HABITAT ALTERATION

The installation of cables connecting the marine hydrokinetic and offshore wind structures to shore would be one type of direct disturbance to benthic habitats in the Northern Study Area. Undersea cable laying technologies use a slit-and-cover technique, in which the surface of the sediment is parted in a slit, the cable is placed in the slit, and the sediment is allowed to close back over the cable (Meggitt and Wilson 2003), minimizing impacts to habitat and biota. The potential impact of the cable(s) crossing sensitive habitats is greater in the shallow subtidal and intertidal regions connecting to the shoreside electrical grid than it is in deeper regions, as the nearshore habitats are limited in geographic scope and provide support for life stages of almost all commercially and recreationally important marine species at some time in their life history (Michel et al. 2007).

Devices can also alter benthic habitats and smother benthic communities when anchors are placed on the seafloor habitats. Although the localized effects would probably be small, the placement of many structures in an area or along the coastline could have a cumulative deleterious effect. Replacing soft substrate with artificial hard substrate could create conditions for colonization by many plant and animal species, forming extensive fouling communities

(Boehlert et al. 2008). This habitat conversion is sometimes viewed as beneficial, because it aids in creating increased local habitat types and species diversity, but should be viewed as a potential negative impact, first by conversion of habitat, and second by the likely detrimental effects on the local benthos. The extensive epifaunal communities that develop on these structures could include taxa that have intrinsic value (e.g., provide habitat for rare species) or economic value (e.g., mussels harvested for commercial sale). Shells that fall off structures and accumulate on the sea floor could alter benthic habitat by creating hard surfaces that organisms could colonize (Bomkamp et al. 2004). Bomkamp et al. (2004) reported that mobile invertebrate populations occurring beneath offshore oil platforms or at shell mounds found where platforms once existed differed from those on nearby soft-bottom areas. The removal of masses of living fouling organisms during cleaning of structures could create an area of low dissolved oxygen below the structure as the organisms decay (Boehlert et al. 2008).

It may be necessary in certain locations to protect the structure on the sea floor from current-caused erosion by placing rock armoring, particularly on the soft bottom of the Northern Study Area. This armoring would change the benthic habitat from soft sediment to rock, with the potential development of a fouling community similar to that on the structure itself. The rock armoring would differ from the structure by providing some additional habitat in the spacing between the rocks.

New underwater structures could provide habitat for invasive species, as has been found for oil platforms (Page et al. 2006). Should invasive species become relatively abundant on platforms, their occurrence may affect the manner in which structures serve as functional surrogates for natural reefs; the structures could act as stepping stones for the conveyance of invasive species along the coast (Boehlert et al. 2008).

20.6 CHANGES TO SURFACE WATER CHARACTERISTICS AND CURRENT PATTERNS

Surface structures on renewable energy installations may affect wave and current regimes (Boehlert et al. 2008). As described in [section 6.1](#), there is a strong connection between surface waters and the benthos. Any change to the surface waters could significantly affect the benthos, particularly if those changes affect food deposition to the sea floor. Changes to current patterns could also affect benthic biota. Several recent studies have described the importance of ocean currents on larval transport and settlement of benthic invertebrates (Shanks and Eckert 2005; Broitman et al. 2008). Altered currents could adversely affect these processes locally and regionally.

The structure of intertidal communities is strongly affected by waves, which allow for the creation of new spaces for colonization or for the vertical extension of the communities (Schoch et al. 2006). Community structure could be altered as a result of wave energy harvest offshore, which would reduce wave heights.

20.7 SUMMARY AND DATA GAPS

The main effects of renewable energy structures and operations on benthic organisms will occur because of changes or displacement of the habitats on which the organisms depend. The changes may occur during deployment, operations, and decommissioning of the facilities due to the placement and footprint of anchors, from changes in sediment transport due to energy removal from the system, and from changes in sedimentation caused by the presence of surface structures interrupting natural wave forms and ocean currents. Impacts on benthos may occur along the cable route from energy facilities to shore, particularly in the sensitive and highly productive intertidal and shallow subtidal habitats. Violent Pacific storms may cause breakage of portions of renewable energy platforms, surface and subsurface flotation, and anchoring mechanisms; physical damage to benthic habitats and communities can result from the sinking or washing ashore of these components. Leaching of chemicals from coatings, paints, and lubricants may cause acute or chronic toxicity to benthos in the vicinity of renewable energy structures. The effects of noise, particularly on large invertebrates, has not been well studied and clearly should be a focus of future research.

Changes in the intensity of wave action could alter the longshore transport on beaches, affecting soft-bottom communities, and the community structure of the rocky intertidal zone. Data are needed that examines the degree to which changes in sedimentation patterns caused by renewable energy facilities will affect deep- and shallow-water benthic habitats. Investigations are needed to determine the toxicity of particular chemical coatings and paints to benthic organisms. Development of less toxic alternative coatings and paints is also needed.

20.8 LIST OF LITERATURE CITED—BENTHOS

- Bain, H. 2007. The Potential Impacts of Seismic Exploration on Invertebrates. In: R.D. Walmsley (Compiler). Proceedings of a Workshop on Research Priorities: The Impacts of Seismic Exploration Activities on Marine Invertebrates. September 2007. Offshore Energy Environmental Research Association, Halifax, Nova Scotia.
- Boehlert, G.W, G.R. McMurray and C.E. Tortorici (eds.). 2008. Ecological effects of wave energy in the Pacific Northwest. U.S. Dept. of Commerce, NOAA Tech. Memo. NMFS-F/SPO-92, 174 pp.
- Bomkamp, R.E., H.M. Page and J.E. Dugan. 2004. Role of food subsidies and habitat structure in influencing benthic communities of shell mounds at sites of existing and former offshore oil platforms. *Marine Biology* 146(1):201-211.
- DONG Energy, Vattenfall, The Danish Energy Authority and The Danish Forest and Nature Agency. 2006. Key Environmental Issues Danish Offshore Wind. Danish Energy Authority. <http://ens.netboghandel.dk>. 144 pp.
- Govoni, J.J., M.A. West, L.R. Settle, R.T. Lynch and M.D. Greene. 2008. Effects of underwater explosions on larval fish: Implications for a coastal engineering project. *Journal of Coastal Research* 24(2B):228-233.

- Meggitt, D.J. and J.V. Wilson. 2003. Requirements for monitoring environmental impact of seafloor cables: issues and answers. *Oceans 2003*, September 22-26, 2003. Proceedings, vol. 4: 2058-2062.
- Michel, J, H. Dunagan, C. Boring, E. Healy, W. Evans, J. Dean, A. McGillis and J. Hain. 2007. Worldwide synthesis and analysis of existing information regarding environmental effects of renewable energy uses on the Outer Continental Shelf. U.S. Dept. of the Interior, Minerals Management Service. MMS OCS Report 2007-38.
- Page, H.M., J.E. Dugan, C.S. Culver and J.C. Hoesterey. 2006. Exotic invertebrate species on offshore oil platforms. *Marine Ecology-Progress Series* 325:101-107.
- Schoch, G.C., B.A. Menge, G. Allison, M. Kavanaugh, S.A. Thompson and S.A. Wood. 2006. Fifteen degrees of separation: Latitudinal gradients of rocky intertidal biota along the California Current. *Limnology and Oceanography* 51(6):2564-2585.
- Shanks, A.L. and G.L. Eckert. 2005. Population persistence of California Current fishes and benthic crustaceans: a marine drift paradox. *Ecological Monographs* 75:505-524.
- Snelgrove, P.V.R. and C.A. Butman. 1994. Animal-sediment relationships revisited: Cause versus effect. *Oceanography and Marine Biology: An Annual Review* 32:111-177.
- Wilber, D.H. and D.G. Clarke. 2001. Biological effects of suspended sediments: A review of suspended sediment impacts on fish and shellfish with relation to dredging activities in estuaries. *North American Journal of Fisheries Management* 21:855-875.

21. FISH

For alternative energy development, significant data gaps exist in biological impacts. The Boehlert et al. (2008) report represents the results of a workshop attended by 50 U.S. experts from a variety of fields, held in order to (1) “develop an initial assessment of the potential impacting agents and ecological effects of wave energy development,” and (2) “formulate a general conceptual framework of physical and biological relationships that can be applied to specific wave energy projects.” The results of the workshop should be considered opinions of scientific experts, rather than statements of fact. In this document, statements referring to Boehlert 2008 are worded to indicate that they are potential impacts; where other scientific evidence is available, the original citation will be used.

21.1 EFFECT OF STRUCTURES ON THE MARINE FOOD WEB

Construction of marine hydrokinetic or offshore wind facilities will create structures in the water column and on the ocean floor, which may lead to changes in local communities, create new habitat, and affect fish populations due to fishing closures. Once arrays of wave buoys or offshore wind platforms are placed in the areas designated for their use, the surrounding waters could become *de facto* marine reserves or Marine Protected Areas: closing the area around a facility to fishing could have the same effect as creating a marine reserve. It has been suggested that marine reserves can increase local populations, in both density and average size, and improve fish stocks in the area (Gell and Roberts 2002), but positive results are not universal. Reserves also have the ability to harbor predators and create trophic cascades where lower trophic levels are suppressed as predator populations thrive (Pinnegar et al. 2000). There have been no definitive studies at the National Marine Sanctuaries or other large marine reserves in the Northern Study Area to verify the impact of the reserves on fish populations. The impacts of offshore wind and marine hydrokinetic devices on a particular fish of interest will depend on the position the fish occupies in the food web and the propensity of the fish to be attracted to the platforms or devices.

The addition of physical structures in the water column and on the underlying sea floor will also impact local fish populations. Structures in the open water column are likely to act as artificial reefs, attracting smaller fish, which may in turn attract larger predators (Pelc and Fujita 2002, Boehlert et al. 2008). Another potential example is the attraction of fish that preyed on hard-bottom substrates into a soft-bottom area; they may begin to feed on local soft-bottom organisms (Langlois et al. 2005). Any recruitment could lead to adaptations in the community structure; similarly it could also lead to the same trophic cascades described above. In addition, depending on the nature of the natural substrate, anchors and cables may create new hard substrate on a soft bottom, or replace existing hard substrate. New hard bottom can be expected to act like natural hard-bottom substrate, attracting a new fish assemblage to the area. If hard substrate already exists at the location, existing complexity (biotic and abiotic) could be damaged by the anchors or cables. With time, the new substrate may start to behave like the natural substrate and support a similar community; there are no documented experiments to verify whether the substrate will return to its previous function or evolve into a new substrate supporting a new community of benthic organisms and fish.

Installation of wave farms and offshore wind parks will remove open water pelagic habitat. Habitat for large pelagic fish like albacore tuna (*Thunnus alalunga*), ocean sunfish (*Mola mola*), and several species of pelagic sharks will decrease after installation, although the large areal extent of the continental shelf in the Northern Study Area will ensure that the organisms can avoid the structures if they choose (U.S. DOE 2009).

21.2 EFFECTS ON MIGRATORY PATTERNS

Boehlert et al. (2008) suggest that fish migratory patterns could potentially be affected by offshore structures, as these structures may create auditory, chemical, or electromagnetic interference in the localized area, especially for species such as sharks and salmon. It is unlikely that there will be real physical impediments to migration, as most of the fish species are fairly mobile. However, the actual effects of alternative energy systems on fish migration have not been studied (Gill 2005).

21.3 EFFECTS ON LARVAL STAGES

Dispersal of fish larvae in the vicinity of alternative energy structures may be disrupted if the structures are large enough. The above-and-below-water portions of offshore wind and marine hydrokinetic devices could potentially dampen local wave energy and currents (Pelc and Fujita 2002). Many fish species rely on the energy these forces impart for mixing water layers and providing transport for larval stages (Shanks and Eckert 2005). Reducing wave and current energy could lead to larval settlement in undesirable habitat near the structure, which may be detrimental to their development; similarly the reduced wave and current energy could reduce the distances over which larvae will disperse, limiting a species or assemblage's spread. There may be increased predation on fish larvae from planktivorous species attracted to the structures, creating a hostile environment for larvae and reducing their survival. Wave energy devices and offshore wind parks may disrupt sediment transport and thus may have an effect on larval fish. Increased turbidity can decrease larval fish abilities to search and capture prey, although some species such as Pacific herring seem to improve their food capture with some increase in turbidity (Boehlert and Morgan 1985).

Wave generation devices that use “overtopping” with the energy generation process might entrain embryonic, larval and small fish (Michel et al. 2007). The volume of water entrained compared to the number of sensitive organisms per volume of water in the area could be used to estimate an impact. Little is known on fish entrainment in these devices and fish populations.

Deployment, maintenance and decommissioning activities may create additional vessel traffic around renewable energy installations. Direct mortality of ichthyoplankton from vessel traffic has been documented (Killgore et al. 2001; Pearson 1989), with a good discussion of the background in Killgore (2000). These effects can be from vessel generated turbulence and shear, impacts on the hull and propeller, abrasion, waves and drawdown (Pearson 1989). Killgore et al. (2001) simulated propeller shear effects on several riverine fish species. Shear stress levels between 634 and 5,743 dynes/cm² were tested (for comparison towboat propeller shear stress in navigable rivers can be greater than 5,000 dynes/cm²) using a scale towboat propeller model. Mortality was linear with shear stress, and smaller larvae had higher mortalities than larger

larvae. However, field data on vessel-induced mortality is lacking. Holland (1986) working on the upper Mississippi River found damage to eggs, but not to larvae or small fish. Gutreuter et al. (2003) developed a methodology for estimating mortality rates in confined river channels from mortality data sampled following towboats in combination with dispersion modeling, used by EPA in the 2007 decision that “towboat traffic is a source of incidental mortality to adult pallid sturgeon.” Again, comparable studies are not available for coastal waters and mortality estimates during critical fish reproduction and migration periods are needed for estimation of any effects.

The Food and Agriculture Organization of the United Nations warns “the damage caused by the propeller to the zooplankton is relatively low, but considerable losses may be caused by combustion engines whose exhausts are blown under the water surface” (<http://www.fao.org/DOCREP/003/W3732E/w3732e0s.htm>). The supporting research was not quoted. There has been research on subsurface exhausts of two-cycle engines (e.g. Tjärnlund et al. 1995) that found significant toxicity in fish.

21.4 EFFECTS ON THREATENED AND ENDANGERED SPECIES

Threatened and endangered salmonids, including chum salmon, coho salmon, and steelhead, as well as the North American green sturgeon and delta smelt migrate through the Northern Study Area and are potentially at risk when alternative energy installations are sited, installed and operated. There are no studies that specifically address the likely impacts of the structures and operations of alternative energy facilities on these species. Studies are needed that specifically address these species prior to and during installation and operation of wave or current energy facilities and offshore wind parks.

21.5 NOISE AND VIBRATIONS DURING DEVELOPMENT, OPERATION, AND REMOVAL OF STRUCTURES

Deployment, operation, maintenance, and decommissioning of offshore wind and hydrokinetic devices can produce noise that affects fish (Michel et al. 2007; USDOJ, MMS 2007; Wahlberg and Westerberg 2005). Sound generated from offshore wind and hydrokinetic devices during operation is small compared to in-water construction activities such as pile driving; explosives used during construction activities and decommissioning could produce high-level sounds for short periods of time (Nedwell and Howell 2004).

Hearing capabilities in fish range widely among species, although most fish can hear within the frequency range of 60 to 3,000 Hz, with sensitivity to sound levels as low as 50 to 110 dB (Vella et al. 2001). Sound transmitted in water as pressure waves may cause temporary hearing loss and damage auditory tissue (generally sensory hair cells of the ear) and nonauditory tissue. The hearing capabilities and sensitivity of a fish species to noise are dependent upon factors including audible threshold, presence of a swim bladder (fish with swim bladders are more sensitive), size of the swim bladder (larger swim bladders mean higher sensitivity), coupling of the swim bladder to the ear, and attributes of the otolith system (Vella et al. 2001).

Impacts to fish from anthropogenic sound range from behavioral responses and “auditory masking” (interference with biologically relevant sounds needed for predator avoidance, prey location, or communication) to physiological damage including temporary or permanent hearing loss, and even mortality (Hastings and Popper 2005; Popper 2005; McCauley et al. 2003). The nature of any impacts is dependent upon the level and duration of sound exposures experienced by fishes in the project area. Noise generated by pile-driving activities for installation of met towers or monopiles could result in physiological damage to fish (USDOJ, MMS 2007). Research on the effects of pile driving on fish is ongoing; early results indicate that pile-driving noise can affect the hearing thresholds of salmonids and other species, and may result in death (Popper 2005; Popper et al. 2006).

McCauley et al. (2003) and Popper et al. (2005) investigated impacts to fish from high-intensity anthropogenic sound produced by airguns used in seismic surveys. Although these sounds are louder and of longer duration than construction activity associated with offshore wind and hydrokinetic devices, the results may be instructive (Nedwell and Howell 2004). McCauley et al. (2003) reported extensive damage to ears of pink snapper (*Pagrus auratus*) exposed to operating airguns in a caged experiment, but noted that noise avoidance behavior, typical of fish, may reduce physical damage from high-intensity sound under real-world conditions. Alternative energy structures in the Northern Study Area are unlikely to require significant infrastructure installed on the sea floor, nor the extensive use of airguns that characterize oil and gas exploration or installation of alternative energy installations in shallower waters, such as the OCS of the Atlantic. However installation and decommissioning activities that may generate extensive noise in the Northern Study Area will need to be monitored for potential harm to fish. The use of explosives for removal of meteorological towers or project structures during decommissioning would also have physiological impacts to fish that, depending on distance from the source, could include mortality (Hastings and Popper 2005).

During deployment, maintenance, and decommissioning of offshore wind and wave projects there will be an increase in noise from vessels (USDOJ, MMS 2007). Offshore wind parks will emit low-level, constant background noise throughout operation that may cause auditory masking (Wahlberg and Westerberg 2005; Popper et al. 2006). Low-level noise generated by such projects may also bring about behavioral responses (such as avoidance or attraction) to low-level noise may also occur and could interrupt normal feeding, migration, or other activities (Wahlberg and Westerberg 2005). The distance at which fish may hear operating wind turbines is difficult to determine and varies among species (Wahlberg and Westerberg 2005).

Criteria have been developed to reduce the potential impacts to fish from work done at conventional hydropower facilities (Popper 2005; Popper et al. 2006). However, the effects of low-level, persistent noise and vibration are largely unknown for fish (Pelc and Fujita 2002; Boehlert et al. 2008). It is unlikely that such sounds will have the same effects in fish as in marine mammals; however, damage has been recorded in fish from loud noises associated with construction in water (Popper 2005; Popper et al. 2006). Fish also possess sensitive lateral lines and could be impacted by persistent noise from operations of alternative energy installations (Thomsen et al. 2006).

21.6 EFFECTS OF ELECTROMAGNETIC FIELDS

Offshore wind and marine hydrokinetic devices have cables that connect the devices to one another, as well as the transmission cables to shore. Cables have the potential to emit electromagnetic fields (EMF) in water (Musial 2008). Most ocean energy transmission cables use alternating current (AC), which has the potential to emit EMF; newer technologies are looking at increased use of direct current (DC) cabling, which does not emit EMF (Woodford 1998).

A number of aquatic organisms including fish are known to be sensitive to EMF; EMF affects behavior and foraging ability (Gill et al. 2005). Sensory organs have been identified in fish that detect electric and magnetic fields (Bullock et al. 2005; Collin and Marshall 2003; Hara and Zielinski 2007). The magnetic fields found in nature are similar to those generated by a DC current passing through a conductor. Almost nothing is known about the response of aquatic biota to the electric and magnetic fields generated by the flow of AC current through a conductor (Gill 2005). These fields are fundamentally different from those that these animals have adapted to over millennia. It is unclear how their sensory organs will respond to these alternating fields, and what effects these fields may have on the function of the animals that depend upon these sensory modalities.

21.7 CHEMICAL LEACHING (PAINTS, ANTIFOULING COATINGS)

A group of experts in marine fisheries focused on potential impacts of renewable energy installations on fish in the Northern Study Area that was published (Boehlert et al. 2008). The expert opinion (Boehlert et al. 2008) suggests that chemicals used as antifouling agents and petroleum-based lubricants that leach off platforms and moorings of wave and offshore wind generators could prove toxic to fish, particularly susceptible larvae. It is not known what chemicals will be used in these structures or if they will be biologically available to communities around the structure or downstream. If toxic chemicals are released from the platforms, there is a potential for those toxins to bioaccumulate in the food chain; many fish species could retain high concentrations with unknown effects (Boehlert et al. 2008). As new antifouling paints and surfaces are developed specifically for the offshore energy sector, investigations for potential toxicity to fish larvae and adults will be needed.

Marine hydrokinetic devices contain relatively small amounts of petroleum-based products for lubrication of gearboxes, generally less than 50 barrels (USDOJ, MMS 2007), and are unlikely to cause widespread spills; however larval fish are known to be sensitive to small amounts of oil (Marty et al. 1997). Embryonic Pacific herring (*Clupea pallasii*) develop cardiac arrhythmia at very low levels of PAHs (Incardona et al. 2009).

Offshore wind installations require electrical service platforms (ESP) to convert electricity to voltages appropriate for transmission to shore; ESP transformers may contain up to 40,000 gallons of petroleum-based product, generally a light mineral oil (USDOJ, MMS 2007). The industry maintenance standard requires checking the oil on ESPs twice a year and replacing it every 10 years; these maintenance activities could produce increased risk of spills (USDOD,

Army Corps of Engineers 2006). A spill of the entire volume of oil could prove catastrophic for fish larvae and other sensitive forms, and it could cause widespread food web bioaccumulation.

21.8 INCREASED VESSEL TRAFFIC

Entrainment and impingement of organisms is a major concern when utilizing seawater if the quantity of seawater use is large. Major sources of consumption include intake for platform operations and shipping operations, both cooling water and ballast water. Of these, ballast water is the largest component and impacts to the plankton communities will depend on the volume of ship traffic to any given location. Cargo vessels take on or release large quantities of ballast water when on- and offloading. This major consumption of water results in the entrainment of pelagic fish eggs and larvae, which are either killed or transported to a new location (USDOJ, MMS 2007). Small pelagic eggs and larval stages of fish can be entrained while medium sized organisms would be impinged at the intake. Impacts to localized fish populations, via ichthyoplankton entrainment, have the potential to be significant if water usage is large and continuous over a long time period. Additionally, loss of young individuals can have impacts on future production of the population and food web.

Another impact of water usage and increased vessel traffic is the transportation of species between water bodies. The continued introduction of alien species is a major concern on the West Coast of the United States, with Los Angeles/Long Beach Harbor being one of the busiest ports in the country. While species transport between the OCS and the mainland is not a major concern, as most species are likely to be found in both locations, any vessel originating from other locations could potentially bring new invasive species to the area. Adverse impacts of invasive species include declining native populations and alterations in the food web (USDOJ, MMS 2007).

21.9 SUMMARY AND DATA GAPS

The scarcity of empirical research on operational alternative energy systems represents a significant data gap in the analysis of likely impacts. Fish in the Northern Study Area may be affected by alternative energy installations and operations in a variety of ways. Aggregation around structures and moorings may allow predators to more easily pick off prey, impacting fish populations, particularly those species that are endangered or threatened. Avoidance of structures may cause impacts as migrating fish expend additional energy to swim around offshore wind parks or wave farms. Noise from installation and decommissioning activities may harm sensitive fish hearing, although levels may not be loud enough for significant impairment. EMF may affect fish in the vicinity of devices and cables. Leaching of chemical coatings and paints, as well as spills of petroleum products, may cause acute or chronic toxicity to fish, particularly sensitive early life stages including embryos and larvae.

Additional data are needed to understand the behavior of fish around surface floats in order to determine whether the aggregation that these structures encourage may have an impact on populations, particularly those that are threatened or endangered. An improved understanding of the impact of noise and EMF on fish is needed, as is an understanding the specific impacts of chemical coatings and anti-fouling paints.

21.10 LIST OF LITERATURE CITED—FISH

- Boehlert, G.W, G.R. McMurray and C.E. Tortorici (eds.). 2008. Ecological effects of wave energy in the Pacific Northwest. U.S. Dept. of Commerce, NOAA Tech. Memo. NMFS-F/SPO-92, 174 pp.
- Boehlert, G.W. and J.B. Morgan. 1985. Turbidity enhances feeding abilities of larval Pacific herring, *Clupea harengus pallasii*. *Hydrobiologia* 123(2):161-170.
- Bullock, T.H, C.D. Hopkins, A.N. Popper and R.R. Fay (eds.). 2005. Electroreception. Springer: New York, NY.
- Collin, S.P. and N.J. Marshall. 2003. Editors. Sensory processing in aquatic environments. Springer: New York, NY.
- Gell, F.R. and C.M. Roberts. 2002. The fishery effects of marine reserves and fishery closures. WWF-US, Washington DC.
- Gill, A.B. 2005. Offshore renewable energy: Ecological implications of generating electricity in the coastal zone. *Journal of Applied Ecology* 42:605-615.
- Gill, A.B., I. Gloyne-Phillips, K.J. Neal and J.A. Kimber. 2005. The potential effects of electromagnetic fields generated by sub-sea power cables associated with offshore wind farm developments on electrically and magnetically sensitive marine organisms—A review. Final Report: COWRIE-Collaborative Offshore Wind Energy Research into the Environment; COWRIE-EM FIELD 2-06-2004.
- Gutreuter, S., J.M. Dettmers and D.H. Wahl. 2003. Estimating mortality rates of adult fish from entrainment through the propellers of river towboats. *Transactions of the American Fisheries Society* 132:646-661.
- Hara, T. and B. Zielinski. 2007. Sensory systems neuroscience. Elsevier: New York, NY.
- Hastings, M. and A. Popper. 2005. Effects of sound on fish. Report prepared for California Dept. of Transportation. CA05-0537. Sacramento CA. 85 pp.
- Holland, L.E. 1986. Effects of barge traffic on distribution and survival of ichthyoplankton and small fishes in the upper Mississippi River. *Transactions of the American Fisheries Society* 115: 162-165.
- Incardona, J., M.G. Carls, H.L. Day, C.A. Sloan, J.L. Bolton, T.K. Collier and N.L. Scholz. 2009. Cardiac arrhythmia is the primary response of embryonic Pacific herring (*Clupea pallasii*) exposed to crude oil during weathering. *Environmental Science & Technology*, 43(1):201-207.
- Killgore, K., S.T. Maynard, M.D. Chan and R.P. Morgan II. 2000. Interim Report For the Upper Mississippi River – Illinois Waterway System Navigation Study: Evaluation of

- Propeller Induced Mortality on Early Life Stages of Selected Fish Species. U.S. Army Corps of Engineers, ENV Report 30, 24 pp.
- Killgore, K., S.T. Maynard, M.D. Chan and R.P. Morgan, II. 2001. Evaluation of propeller-induced mortality on early life stages of selected fish species. *North American Journal of Fisheries Management* 21:947-955.
- Langlois, T.J., M.J. Anderson and R.C. Babcock. 2005. Reef-associated predators influence adjacent soft-sediment communities. *Ecology* 86:1508–1519.
- Marty, G.D., J.E. Hose, M.D. McGurk, E.D. Brown and D.E. Hinton. 1997. Histopathology and cytogenetic evaluation of Pacific herring larvae exposed to petroleum hydrocarbons in the laboratory or in Prince William Sound, Alaska, after the Exxon Valdez oil spill. *Can. J. Fish. Aquat. Sci.* 54:1846–1857.
- McCauley, R., J. Fewtrell and A. Popper. 2003. High-intensity anthropogenic sound damages fish ears. *J. Acoust. Soc. Am.* 113(1):638-642.
- Michel, J., H. Dunagan, C. Boring, E. Healy, W. Evans, J. Dean, A. McGillis and J. Hain. 2007. Worldwide synthesis and analysis of existing information regarding environmental effects of alternative energy uses on the Outer Continental Shelf. U.S. Dept. of the Interior, Minerals Management Service. MMS OCS Report 2007-38.
- Musial, W. 2008. Status of wave and tidal power technologies for the United States. TechReport NREL/TP-500-43240.
- Nedwell, J. and D. Howell. 2004. A review of offshore windfarm related underwater noise sources. London, COWRIE. 63.
- Pearson, W.D. 1989. Environmental Impact Research Program: Environmental Effects of Navigation Traffic: Studies on Fish Eggs and Larvae. Army Engineer Waterways Experiment Station Vicksburg, MS, Environmental Lab (abstract available only).
- Pelc, R. and R.M. Fujita. 2002. Renewable energy from the ocean. *Marine Policy* 26(6):471-479.
- Pinnegar, J.K., N.V.C. Polunin, P. Francour, F. Badalamenti, R. Chemello, M.L. Harmelin-Vivien, B. Hereu, M. Milazzo, M. Zabala, G. D'Anna and C. Pipitone. 2000. Trophic cascades in benthic marine ecosystems: Lessons for fisheries and protected-area management. *Environmental Conservation* 27:179-200.
- Popper, A.N. 2005. What do we know about pile driving and fish? In: Irwing, C.I., P. Garrett, and K.P. McDermott. Proceedings of the 2005 International Conference on Ecology and Transportation, San Diego, CA. August 29-September 2, 2005.

- Popper, A.N., T.J. Carlson, A.D. Hawkins, B.L. Southall and R.L. Gentry. 2006. Interim criteria for injury of fish exposed to pile driving operations: A white paper. Washington Dept. of Transportation, June 26, 2006.
- Popper A., M. Smith., P. Cott, B. Hanna, A. MacGillivray, M. Austin and D. Mann. 2005. Effects of exposure to seismic airgun use on hearing of three fish species. *J. Acoust. Soc. Am.* 117(6):3958-3971.
- Shanks, A.L. and G.L. Eckert. 2005. Population persistence of California current fishes and benthic crustaceans: A marine drift paradox. *Ecological Monographs* 75:505-524.
- Thomsen, F., K. Lüdemann, R. Kafemann and W. Piper. 2006. Effects of offshore wind farm noise on marine mammals and fish. COWRIE, Hamburg, Germany.
- Tjärnlund, U., G. Ericson, E. Lindesjö, I. Petterson and L. Balk. 1995. Investigation of the biological effects of 2-cycle outboard engines' exhaust on fish. *Marine Environmental Research* 39:313-316.
- U.S. Dept. of Defense, Army Corps of Engineers. 2006. Cape Wind Energy Project, draft environmental impact statement. Internet website: <http://www.nae.usace.army.mil/projects/ma/ccwf/deis.htm>. Accessed July 13, 2009.
- U.S. Dept. of Energy. 2009. Potential environmental effects of marine and hydrokinetic energy technologies. Report to Congress prepared in response to the Energy Independence and Security Act of 2007, Section 633(b). June 2009. 88 pp. + appendices.
- U.S. Dept. of the Interior, Minerals Management Service (MMS). 2007. Programmatic environmental impact statement for alternative energy development and production and alternate use of facilities on the Outer Continental Shelf. MMS OCS EIS/EA 2007-046.
- Vella, G., I. Rushforth, E. Mason, A. Hough, R. England, P. Styles, T. Holt and P. Thorne. 2001. Assessment of the effects of noise and vibration from offshore wind farms on marine wildlife. Report to ETSU (Dept. of Trade and Industry), W/13/00566/00/REP.
- Wahlberg, M. and H. Westerberg. 2005. Hearing in fish and their reactions to sounds from offshore wind farm. *Mar. Ecol. Prog. Ser.* 288:295-309.
- Woodford, D.A. 1998. HVDC transmission Winnipeg Manitoba Canada, Manitoba HVDC Research Centre. 27pp.

22. SEA TURTLES

Sea turtle populations have been devastated by the impacts of anthropogenic activities. Alternative energy development poses threats to these animals at all stages of development. Potential sources of effects are vessel strikes, noise, lighting, water quality changes, petroleum contamination, and entanglement and suffocation from equipment, trash and debris. Potential impacts to sea turtle species, which are all threatened or endangered, from site characterization, construction, operation, and decommissioning activities could range from negligible to major, depending on the species affected and the nature, duration, and magnitude of the effect. Risk assessments for wind, wave, and ocean current energy projects on the Outer Continental Shelf are discussed in detail in Michel et al. (2007) and Minerals Management Service (USDOJ, MMS 2007).

22.1 NOISE AND VIBRATIONS

Installation of offshore alternative energy includes surveying, pile driving, and cable trenching, all of which result in increased noise levels, degradation of water quality, and increased vessel traffic. Before the installation of structures, activities associated with siting surveys may impact sea turtles. Two methods of surveying are airgun surveys and side-scan sonar (USDOJ, MMS 2007). Airgun surveys generate low-frequency noise that may be detectable to sea turtles, whose hearing is limited to low frequencies (Lutz et al. 2003; USDOJ, MMS 2007). Side-scan sonar generates noise at a higher frequency and at a lower intensity than airgun surveys and is not likely to disturb normal activities. Conversely, construction noise generated by pile driving is much louder and audible over a broader band (USDOJ, MMS 2007). While these sounds could cause changes in behavior or injury, sea turtles are highly mobile and it is believed they would avoid construction activities and stay outside the range of auditory impact.

In environmental assessments of offshore activities, the National Marine Fisheries Service (NMFS) recommends that all noise sources be characterized, any impulsive underwater sound sources greater than 160 decibels relative to one micropascal (dB re 1 μ Pa) or any continuous underwater sound sources greater than 120 dB re 1 μ Pa be quantitatively described (e.g., intensity, duration, frequency range), and these be evaluated for potential impacts to sea turtles. Pile driving is often considered the activity most likely to produce the loudest sounds, on the order of 200 dB re 1 μ Pa, measured at 30 m from the source (Michel et al. 2007).

Table 22.1.

Sound Pressure Levels from Underwater Noise Sources

Impact Type	Sound Pressure Levels
Potential Injury	180 dB re 1 μ Pa
Potential Harassment from Impulsive Noise	166 dB re 1 μ Pa
Potential Harassment from Continuous Noise	120 dB re 1 μ Pa

Note: Evaluation of potential impacts from these sources is recommended by NMFS¹

¹ NOAA Program Planning and Integration, letter from Mr. Steve Kokkinakis, NEPA Coordination and Compliance, to Mr. Mark Prescott, U.S. Coast Guard, December 24, 2008.

The removal of offshore structures includes many of the same procedures as the installation. Above-surface structures are taken apart and shuttled to disposal sites via barges. This activity generates increased vessel traffic. The platform legs and all other submerged structures then need to be removed to at least 5 m below the sea floor. In many cases this requires explosive removal. There are several common explosive removal techniques, including bulk explosive charges, configured bulk charges, and cutting charges (Viada et al. 2008). The impact of an explosion on any organism depends on the distance between the two. Viada et al. (2008) review the potential sources and causes of impacts to sea turtles due to underwater explosions associated with the removal of oil and gas structures. Noninjurious effects include acoustic annoyance and tactile detection or physical discomfort while injurious effects include damage to organs (Viada et al. 2008). Primary blast injuries are usually limited to gas-containing organs (lungs and auditory system), whereas cavitations, the rarefaction waves in the water column, mostly cause noninjurious effects or may increase the impact of a primary blast injury. Nonlethal injuries include permanent damage to the auditory system, commonly leading to hearing loss, and lung hemorrhage. Lethal injuries are a direct result of close proximity to the point of detonation and include extensive lung hemorrhage and associated gastrointestinal tract injuries. Additionally, exposure to peak shock waves can result in brain damage and fractures to the skeleton (Viada et al. 2008). Viada et al. (2008) summarize the little research and sightings of injuries resulting from underwater explosions over the past 30 years.

Wind facilities are designed to operate at a nearly continuous rate and thus the turbines will be a continuous source of noise. Madsen et al. (2006) review the current literature on the underwater noise related to installing and operating wind facilities. The authors conclude that sound generated by an operating wind farm is much less than what is produced by pile driving and other installation procedures (Madsen et al. 2006). However, they do note that turbine noise emits at a low frequency and therefore will be more audible to organisms that hear in this range, including sea turtles. Since the operation noise will be close to constant, turtles are expected to avoid the source of noise before getting close enough to suffer injury. This effect has the potential to increase the cumulative underwater noise if the facility is located near shipping lanes where vessels generate a chronic, sublethal noise level.

22.2 INCREASED VESSEL TRAFFIC

Increased vessel traffic could be a large source of injury or mortality, especially if traffic is increased during periods of higher (seasonal) habitat use. Leatherbacks and loggerheads are commonly sighted foraging off the coast of Northern California in autumn months (Carretta et al. 2005; Peterson et al. 2006); therefore if development activities or servicing events occur at the same time there is a greater chance of effect. It is not known how sea turtles are affected by the noise generated by increased vessel traffic, though it is assumed there must be some temporary impacts (USDOD, NMFS 2002). Adult turtles may avoid areas of high traffic and dive at the approach of a vessel.

An additional impact could arise from the use of bright lighting aboard vessels. The age class most sensitive to artificial lighting is hatchlings, because they use light cues to orient their migration across the beach to the sea and to foraging areas (Witherington and Martin 1996). In

addition to detracting these animals from their natural movements, the lights may also attract birds and fish that prey on the hatchlings, further reducing their survival rate (Michel et al. 2007).

Turtles are generally assumed to be unable to differentiate between prey items and debris in the water. Experiments have shown them to strike at nonfood sources (Vargo et al. 1986), and gut content analyses found over 50 percent of turtles examined had consumed plastics (Boyle and Limpus 2008). Rogue debris from vessels or platforms can entangle turtles or be mistaken for prey, and both can cause injury or death (Magnuson et al. 1990; Lutz and Musick 1997; Lutz et al. 2003). While the dumping of plastics is prohibited, increased human activity ultimately leads to increased gear loss and accidental debris release.

22.3 ENTANGLEMENT

In conjunction with increased vessel traffic to and from installations, there are typically higher numbers of moored vessels around the installation site, which would increase the number of mooring lines in the water. Turtles can become tangled and subsequently become injured or drown after striking a mooring line (Michel et al. 2007). Wave energy facilities require many mooring lines to secure the devices to the ocean floor. Sea turtles swimming through the area may not be able to avoid all of the lines and thus may become entangled. Injury or drowning could result from a strike to one or more of these lines. Sea turtles are generally slow swimmers and thus this is not expected to be a major risk.

22.4 CHEMICAL CONTAMINATION

Antifouling paints and coatings are used to keep organisms from growing on structures submerged in the water. While some types of alternative energy structures (e.g., wind turbine supports) will not be affected by the presence of attached organisms, the use of antifouling paint on other types of structures may be important to the operation of the equipment (e.g., wave energy). The use of antifouling paint on other parts has the potential to affect water quality and cause bioaccumulation of metals and organics in lower trophic level organisms in the immediate vicinity. Most studies investigating this potential issue focus on marinas, where pollutants from large surface areas covered in antifouling paint can have a large impact on the environment. The large surface areas of the sources and the protected (enclosed) nature of these areas create a scenario with high leaching rates and low flushing rates (Schiff et al. 2007). This is not likely to occur at offshore platforms, where leaching chemicals will be quickly diluted. While turtles may be attracted to these structures as sources of increased productivity, there is little chance the organisms living in the water column around these structures will be impacted by leaching chemicals.

22.5 COLLISION POTENTIAL

An operating ocean current energy facility has the potential to affect sea turtles. These facilities are likely to be located in areas frequented by sea turtles because both are utilizing the same current force: one for energy, one for movement. While stationary, turbines could be struck by a swimming turtle, resulting in injury or death; however, due to swimming speeds, turtles are likely to see and avoid these structures. Effects are more likely to occur when the turbines are

rotating. Although their rotational speed will be slower than that of ship propellers (10-12 m/s at the tips, (Frankel 2006)), turbines will still reach a speed at which if a turtle were to be struck, injury or death could occur. In this case, slow swimming speeds could be a disadvantage as animals may not be able to react quickly enough to avoid being struck (Michel et al. 2007).

Another potential impact is the entrainment of hatchlings and small juveniles in the overtopping reservoir. The structural design at the pilot facility in Kaneohe, Hawaii had only one opening at the bottom of the buoy to allow for escape in the event of entrainment (USDOD, Dept. of the Navy 2003). This is not expected to be a major risk in this study area because no nesting beaches are found in the region. This form of alternative energy would also produce a constant low level of sound. The levels are not likely to cause injury but could deter sea turtles from utilizing the area.

22.6 ELECTRIC AND MAGNETIC FIELDS

Energy generated at offshore structures (wind, wave, and current) is transmitted between structures and onto land via a system of cables. When transmitting electricity, these cables produce an electromagnetic field, which may affect sea turtles. Sea turtles use the Earth's magnetic field for orientation, migration, and natal beach homing (Lohmann and Lohmann 1994; Irwin and Lohmann 2003). The electromagnetic field produced by the cables may interfere with the ability of sea turtles to sense the Earth's magnetic field. Little information is available on the effects of electromagnetic fields produced by cables. These fields depend on the material composition of the cable and the charge running through it (Gill et al. 2005). Recent work completed at offshore alternative energy facilities in Europe is summarized in Gill et al. (2005). In an assessment of electromagnetic fields for the Cape Wind project (Massachusetts), investigators determined that cables buried to 6 ft (2 m) would have no adverse impacts on sea turtles (Battelle 2004).

22.7 WASTEWATER AND ACCIDENTAL FUEL LEAKS

Localized and temporary decreases in water quality caused by suspension of sediments are not likely to have a major impact on sea turtles, since they breathe air. However, decreased visibility due to decreased water quality could impair navigation and feeding, but again it is presumed these animals will avoid construction areas. If installation occurs in sea turtle foraging habitat, there is an increased risk to sea turtles due to displacement of prey and, if disturbed sediments are contaminated, the bioaccumulation of toxins via contaminated prey (Gardner et al. 2006).

All alternative energy structures will contain small amounts of petroleum-based operational fluids. These can include electrical insulating oil, diesel fuel, lubricating oil, hydraulic fluids, transformer fluids, etc. (USDOJ, MMS 2007). An accidental leak of any of these fluids could impact sea turtles. A small continuous leak is not likely to have a major impact, as oil will weather and dissipate rapidly into the environment. However, if larger facilities, such as electric service platforms, are constructed in conjunction with the individual energy generators there could be larger sources of fuels associated with the development. Service platforms can have as much as 40,000 gallons of electrical insulating oil on hand (USDOJ, MMS 2007). The instantaneous release of this amount of oil could have detrimental effects to sea turtles in the

area. While a major oil spill is unlikely to be related to offshore alternative energy activities, increased vessel traffic and the presence of structures increase the risk of collisions with and allisions by vessels, some of which could result in spills.

Oil in the water column or at the surface is a risk for all ages of sea turtles, especially because turtles do not exhibit an avoidance behavior when encountering an oil slick (Milton et al. 2003). Oil can irritate the skin of turtles and get caught in their nostrils, mouths, and eyes. This can lead to accidental ingestion of oil (Vargo et al. 1986). Intentional ingestion of tarballs is also a major issue, because turtles eat anything that appears to be the same size as their preferred prey (Vargo et al. 1986). Ingestion can result in starvation from gut blockage, decreased absorption efficiency, absorption of toxins, buoyancy problems from buildup of fermentation gases, and many other effects (Milton et al. 2003). Inhalation of vapor is also a concern for turtles who exhibit diving behavior. Turtles that are preparing for a dive will inhale a large volume of air before submerging. Anything inhaled will then have a prolonged period of time to be absorbed or affect the animal. Sea turtles have not been shown to exhibit avoidance behavior when surrounded by petroleum fumes (Milton et al. 2003).

22.8 ALTERATION OF THE MARINE FOOD WEB

Operations of various types of alternative energy will have varying types of impacts on sea turtles. The physical presence of multiple structures in close proximity could affect sea turtle movement and foraging activities. Increased structured habitat can alter open shoals to a more structured environment, which could disrupt normal behavior (Battelle 2004). In addition, the installation of rigid structures will increase the amount of hard substrate available to marine organisms for colonization. It is likely that many of these facilities will be built in areas with soft sediments, and therefore the addition of a hard structure creates new habitat. This has the potential to support localized communities in areas otherwise uninhabitable by certain species. These new communities could offer a new source of food to sea turtles and attract them to alternative energy installation locations (Milton et al. 2003; Gardner et al. 2006).

22.9 SUMMARY AND DATA GAPS

Sea turtles are uncommon in the Northern Study Area most of the year but can be abundant during the autumnal feeding events off the coasts of California and Oregon. These foraging grounds are important resources for leatherback (USDOC, NMFS & USDO, USFWS 1998a; USDOC, NMFS 2009) and loggerhead sea turtles (USDOC, NMFS & USDO, USFWS 1998b). Alterations to foraging grounds could result in the displacement of individuals or populations. Displacement could lead to reduced reproduction, as other foraging grounds may not be able to support the displaced population. These cascading effects need to be carefully considered when developing within sea turtle foraging grounds.

Several topics discussed require further research. The effects of noise have been studied but more complete information is needed to fully understand the risk of chronic sound and response behaviors. Additionally, the effects of electromagnetic fields are not well understood. Sea turtles navigate using electromagnetic cues from the Earth and disruption or masking of that

signal could have pronounced effects on migration and the ability to locate foraging or nesting grounds.

22.10 LIST OF LITERATURE CITED—SEA TURTLES

- Battelle. 2004. Marine Biological Assessment for the Cape Wind Project, Nantucket Sound. U.S. Army Corps of Engineers. APP. 5.5-A.
- Boyle, M. and C. Limpus. 2008. The stomach contents of post-hatchling green and loggerhead sea turtles in the southwest Pacific: an insight into habitat association. *Marine Biology* 155 (2): 233-241.
- Carretta, J., T. Price, D. Petersen and R. Read. 2005. Estimates of Marine Mammal, Sea Turtle, and Seabird Mortality in the California Drift Gillnet Fishery for Swordfish and Thresher Shark, 1996-2002. *Marine Fishery Review* 66 (2): 21-30.
- Frankel, P. 2006. Tidal current energy technologies. *Ibis* 148: 145-151.
- Gardner, S., S. Fitzgerald, B. Vargas and L. Rodríguez. 2006. Heavy metal accumulation in four species of sea turtles from the Baja California Peninsula, Mexico. *BioMetals* 19 (1): 91-99.
- Gill, A., I. Gloyne-Phillips, K. Neal and J. Kimber. 2005. The potential effects of electromagnetic fields generated by sub-sea power cables associated with offshore wind farm developments on electrically and magnetically sensitive marine organisms—a review. Collaborative Offshore Wind Energy Research Into the Environment, Cranfield University and Centre for Marine and Coastal Studies Ltd.
- Irwin, W. and K. Lohmann. 2003. Magnet-induced disorientation in hatchling loggerhead sea turtles. *Journal of Experimental Biology* 206 (3): 497-501.
- Lohmann, K. and C. Lohmann. 1994. Detection of magnetic inclination angle by sea turtles: a possible mechanism for determining latitude. *Journal of Experimental Biology* 194 (1): 23-32.
- Lutz, P. and J. Musick. 1997. *Biology of Sea Turtles*. Boca Raton: CRC Press.
- Lutz, P., J. Musick and J. Wynken. 2003. *Biology of Sea Turtles Volume II*. Boca Raton: CRC Press.
- Madsen, P., M. Wahlberg, J. Tougaard, K. Lucke and P. Tyack. 2006. Wind turbine underwater noise and marine mammals: Implications of current knowledge and data needs. *Marine Ecology Progress Series* 309 279-295.
- Magnuson, J., K. Bjorndal, W. Dupaul, G. Graham, D. Owens, C. Peterson, P. Pritchard, J. Richardson, G. Saul and C. West. 1990. *Decline of sea turtles: causes and prevention*. National Research Council, National Academy of Science Press, Washington DC.

- Michel, J., H. Dunagan, C. Boring, E. Healy, W. Evans, J.M. Dean, A. McGillis and J. Hain. 2007. Worldwide Synthesis and Analysis of Existing Information Regarding Environmental Effects of Alternative Energy Uses on the Outer Continental Shelf. MMS OCS Report 2007-038.
- Milton, S., P. Lutz and G. Shigenaka. 2003. Oil toxicity and impacts on sea turtles. In: G. Shigenaka. Oil and Sea Turtles: Biology, Planning, and Response. U.S. Dept. of Commerce, National Oceanic and Atmospheric Administration (NOAA), NOAA's National Ocean Service, Office of Response and Restoration.
- Peterson, B., R. Emmett, R. Goericke, E. Venrick, A. Mantyla, S.J. Bograd, F.B. Schwing, S. Ralston, K.A. Forney, R. Hewitt, N. Lo, W. Watson, J. Barlow, M. Lowry, B E. Lavaniegos, F. Chavez, W.J. Sydeman, D. Hyrenbach, R.W. Bradley, P. Warzybok, K. Hunter, S. Benson, M. Weise and J. Harvey. 2006. The state of the California current, 2005-2006: Warm in the North, Cool in the South. California Cooperative Oceanic Fisheries (CalCOFI) Investigations Reports 47: 30-74.
- Schiff, K., J. Brown, D. Diehl and D. Greenstein. 2007. Extent and magnitude of copper contamination in marinas of the San Diego region, California, USA. Marine Pollution Bulletin 54 (3): 322-328.
- U.S. Dept. of Commerce, National Marine Fisheries Service (NMFS) and U.S. Dept. of the Interior, Fish and Wildlife Service (USFWS). 1998a. Recovery Plan for U.S. Pacific Population of the Leatherback Turtle (*Dermochelys coriacea*). U.S. Dept. of Commerce, National Oceanic and Atmospheric Administration, National Marine Fisheries Service, U.S. Dept. of Interior, Fish and Wildlife Service.
- U.S. Dept. of Commerce, National Marine Fisheries Service (NMFS) and U.S. Dept. of the Interior, Fish and Wildlife Service (USFWS). 1998b. Recovery Plan for U.S. Pacific Population of the Loggerhead Turtle (*Caretta caratta*). U.S. Dept. of Commerce, National Oceanic and Atmospheric Administration, National Marine Fisheries Service, U.S. Department of Interior and U.S. Dept. of the Interior, Fish and Wildlife Service.
- U.S. Dept. of Commerce, National Marine Fisheries Service (NMFS). 2002. Endangered Species Act - Section 7 Consultation Biological Opinion. Gulf of Mexico Outer Continental Shelf Lease Sale 184. U.S. Dept. of Commerce, National Marine Fisheries Service, Salmon Recovery Division. Consultation # F/SER/2002/00145.
- U.S. Dept. of Commerce, National Marine Fisheries Service (NMFS). 2009. Revision of Critical Habitat for Leatherback Sea Turtles: Biological Report. U.S. Dept. of Commerce, National Marine Fisheries Service, Office of Protected Resources: November 2009.
- U.S. Dept. of Defense, Dept. of the Navy. 2003. Environmental Assessment Proposed Wave Energy Technology Project, Marine Corps Base Hawaii, Kaneohe Bay, Hawaii. Dept. of the Navy, NAVFAC Pacific Division. 300.

- U.S. Dept of the Interior, Mineral Management Service (MMS). 2007. Programmatic environmental impact statement for alternative energy development and production and alternative use of facilities on the outer continental shelf. Final Environmental Impact Statement. OCS EIS/EA MMS 2007-046. Vol II. 342.
- Vargo, S., P. Lutz, D. Odell, E. Van Vleet and G. Bossart. 1986. Study of the effects of oil on marine turtles. Volume 1-3. Final report, 30 September 1983-1 October 1985. OCS Study MMS 86-0070.
- Viada, S., R. Hammer, R. Racca, D. Hannay, M. Thompson, B. Balcom and N. Phillips. 2008. Review of potential impacts to sea turtles from underwater explosive removal of offshore structures. Environmental Impact Assessment Review 28 (4-5): 267-285.
- Witherington, B. and R. Martin. 1996. Understanding, assessing, and resolving light-pollution problems on sea turtle nesting beaches. Florida Department of Environmental Protection. Technical Report TR-2.

23. BIRDS

For alternative energy development, significant data gaps exist in biological impacts. The Boehlert et al. (2008) report represents the results of a workshop attended by 50 U.S. experts from a variety of fields, held to (1) “develop an initial assessment of the potential impacting agents and ecological effects of wave energy development,” and (2) “formulate a general conceptual framework of physical and biological relationships that can be applied to specific wave energy projects.” The results of the workshop should be considered opinions of scientific experts, rather than statements of fact. In this document, statements referring to Boehlert 2008 are worded to indicate that they are potential impacts; where other scientific evidence is available, the original citation will be used.

23.1 NOISE AND VIBRATION DURING DEVELOPMENT

Noise will be generated by offshore wind parks from the rotation of the rotor; few reliable estimates of the level of this noise have been made (USDOD, Army Corps of Engineers 2006). It is possible that birds could be harmed by sustained exposure to wind turbine noise; however, birds appear capable of avoiding the offshore structures erected in Europe (DONG Energy 2006). The major types of wave generators under development (point attenuation, surface attenuation, oscillating water column) generate small amounts of noise (Musial 2008; USDO, MMS 2007) that are unlikely to affect birds. Further data of the noise levels, frequencies, and proximity to concentrations of birds are needed.

23.2 INCREASED VESSEL TRAFFIC

Increased vessel traffic during construction, maintenance, and decommissioning of wave farms and offshore wind parks could influence foraging of seabirds and migratory birds by temporarily displacing birds from foraging areas, or by obscuring forage from birds with boat wakes. Many seabirds are known to follow oceangoing vessels, as offal rejected from fishing vessels is utilized as forage. Hyrenbach (2001) noted black-footed and Laysan albatross (*Phoebastria immutabilis*) followed survey vessels for up to 60 minutes, with no apparent adverse effects. Increased vessel traffic may also change wave patterns on beaches. Although no literature describing effects of altered wave patterns on shorebirds in the Northern Study Area was found, there is a potential that foraging birds could be affected. Additional information is needed to determine whether the level of increased vessel traffic associated with renewable energy development will have significant adverse effect on birds.

23.3 WASTEWATER AND ACCIDENTAL FUEL LEAKS

Oil spills can have devastating effects on birds, coating their feathers and thus eliminating their ability to regulate their body temperature or preventing them from flying. Petroleum products can also be fatal to birds if swallowed. Wave buoys will carry relatively small quantities of oil, typically less than 50 barrels (USDO, MMS 2007); however, a spill of any amount could prove dangerous for seabirds or other migratory species (Wiese and Robertson 2004). Offshore wind installations require electrical service platforms (ESP) to convert electricity to voltages appropriate for transmission to shore; ESP transformers may contain up to 40,000 gallons of petroleum-based product, generally a light mineral oil (USDO, MMS 2007). The industry

maintenance standard requires checking the oil on ESPs twice a year and replacing it every 10 years; these maintenance activities could produce increased risk of spills (USDOD, Army Corps of Engineers 2006). A spill of the entire volume of oil could prove catastrophic for birds (USDOD, Army Corps of Engineers 2006); however, the light mineral oil used in wind energy ESPs is considerably less toxic than heavier crude oils (Heubeck et al. 2003).

The greatest risk of spills associated with the marine renewable energy development is probably from the vessels used to deploy, maintain, and decommission the installations, according to Wilson et al. (2007). Contaminated water may be released from the platforms in small quantities, increasing the chance of birds encountering chemicals leached from antifouling paints and other coatings (Boehlert et al. 2008).

23.4 MARINE FOOD WEB ALTERATION

Although some observations have been made with respect to individual food items consumed by bird species, estimating the impact of marine food web alteration is very difficult without first knowing how the web would be altered and to what extent (Boehlert 2008). Further attention is needed to determine how avian food chains may be altered.

23.5 IMPACTS OF INFRASTRUCTURE

The development of renewable energy sources, wind energy in particular, raises concerns about potential impacts to birds from collision mortality, habitat loss, avoidance, and disturbance (Drewitt and Langston 2006, Stewart et al. 2007). Taxonomic orders of birds that have experienced significant declines in abundance near wind energy facilities include Anseriformes (waterfowl) and Charadriiformes (shorebirds, gulls, and other seabirds) (Stewart et al. 2007). Although the cause of the declines may not be known, the decline indicates these bird groups were affected (Desholm 2006). One study, using a variety of methods and technologies for direct and indirect measurement, determined that almost half of all migratory birds observed near proposed wind farm sites fly at altitudes that could put them in danger (Hüppop et al. 2006a, b). Experience in Europe has shown that birds generally avoid offshore wind parks in clear weather (DONG Energy 2006); this avoidance does not appear to affect the birds' ability to complete their migratory journeys in clear weather. Inclement weather, particularly fog and rain conditions, increases the incidence of birds colliding with offshore energy structures. Detailed interannual data is needed on bird migratory routes to compare with proposed wind farm sites. Data is not available on hazing or other techniques that would cause birds to avoid wind farms in inclement weather (DONG Energy 2006).

23.5.1 Continuous Lighting and Structure Collision

There have been no studies of bird interactions with offshore devices in the Northern Study Area; studies from Europe provide some insight into possible impacts. Continuous lighting poses a risk to seabirds and migratory birds. Migrant passerines have been attracted to offshore structures in the North Sea with continuous lighting, especially during adverse weather conditions, and large collision mortality events have occurred (Hüppop et al. 2006a, b). The structures are made up of superstructure to support wave or offshore wind generators, the pylons holding up the wind turbines, and associated strengthening components. The extent of the

impacts of offshore structures on birds will depend on whether energy installations are placed in common migratory pathways, and on the incidence of adverse weather during migratory seasons. Data are needed to evaluate if using intermittent lighting rather than bright lights and siting installations away from migratory pathways can reduce bird impacts (Hüppop et al. 2006a, b). The best estimate of mortality rates from wind turbines comes from studies of an offshore wind farm in Denmark, where modeled predictions of mortality due to collision averaged 0.02 percent out of a migratory population of 235,000 common eiders (or 45 birds) (DONG Energy 2006). Infrared video monitoring of the migratory population recorded no collisions, indicating that the modeling estimates are conservative in the direction of overstating mortality.

Seabird collisions with offshore wind platforms have been recorded, often resulting in bird mortality. While the collision rates are generally low for certain populations of seabirds and migratory birds, the effect of collisions on populations may be high. In particular, breeding colonies of seabirds in close proximity to wind turbines mounted on the platforms, long-lived species with low reproductive rates, and species with low productivity were identified as being at high risk from turbine collision mortality (Drewitt and Langston 2006; Everaert and Steinen 2006). Data are needed to assess whether large birds, being less maneuverable, and species that routinely fly at night, dusk, or dawn may also have a higher risk of collision mortality (Drewitt and Langston 2006).

Numerous attempts have been made to model the effects of wind energy developments on bird flight behavior. Attributes related to the facility type and location, as well as species-specific bird behavior, have been examined (Garthe and Hüppop 2004). Avoidance behavior of birds has been observed near offshore wind energy developments (Larsen and Guillemette 2007) and has been identified as the most influential variable in these mortality models. However, avoidance behavior varies among species and is difficult to assess, and little information on specific avoidance behaviors is known (Fox et al. 2006).

23.5.2 Migratory Pathway Alteration

Observations and video monitoring of offshore wind farms show that, among the most numerous species of migratory birds, flocks avoid the vicinity of the wind turbine blades, flying along the periphery of the wind parks (DONG Energy 2006). While avoidance responses are likely to be species-specific, there are no indications that slightly extended migration distances are detrimental to the populations (Michel et al. 2007). However evidence from European wind parks shows that nonmigratory species found over water may not be able to adjust to the lights, ending their flights as victims of blade or structure strike, or dying of exhaustion (Hüppop 2006a).

Roughly two-thirds of all bird species migrate during darkness, increasing the risk of collision with offshore structures when the light is insufficient for the birds to avoid the structures. Data from German and Danish studies using detection methods such as radar, infrared video, and automatic flight call recordings corroborate that the risk of collision is greater at night than during the day (Hüppop et al. 2006a, b; DONG Energy 2006).

In a German study in the North Sea, the majority of collisions were from terrestrial birds (thrushes, starlings, skylarks), with fewer than one percent of the collisions attributable to seabirds (Hüppop et al. 2006a, b), indicating that seabirds may be more adept than terrestrial birds at avoiding the turbines. In the Northern Study Area, offshore wind turbines are likely to be placed five miles or more from shore, lessening the probability of collisions by terrestrial birds. However, the offshore waters of the Northern Study Area make up a substantial portion of the Pacific Flyway, potentially endangering a vast array of migratory birds. Data on the timing of seabird and migratory bird movements through the area of a proposed offshore wind park could help in the design of mitigation strategies for protecting birds against collisions.

Migratory birds fly within 200 m of the sea surface, within the activity radius of wind turbines. On rainy nights, birds tend to fly significantly lower than on clear nights (Hüppop et al. 2006). Of 442 birds representing 21 species, almost all the birds found dead on wind platforms in the North Sea showed signs of having been in good physical condition when they died, ruling out starvation as a cause of death; almost half had visible injuries including bleeding from the bill, skull contusions, and broken legs. It is believed that many birds may have died of exhaustion flying around well-lit platforms, particularly nonmigratory birds (Hüppop et al. 2006a, b). Visual observations recorded birds flying around lit platforms repeatedly, particularly on dark and rainy nights. Monitoring studies have not been done that could determine these types of mortalities.

23.6 EFFECTS OF MANY LARGE, STATIONARY DEVICES ON MIGRATORY PATTERNS

As offshore wind parks are developed, practical strategies for mitigating bird strikes by migratory birds are needed. Studies in Germany and Scotland have suggested that renewable energy development should: (a) avoid zones of dense bird migrations; (b) align rows of turbines parallel to the main migratory direction, allowing birds safe passage between the rows of turbines; (c) avoid construction of wind parks between resting and foraging grounds; (d) shut down turbines when bad weather and poor visibility coincide with peak migrations; (e) curtail continuous illumination; and (f) explore ways to make turbines more visible to birds (Hüppop et al. 2006a, b; Gill 2005). Data on bird impacts from individual wind parks need to be combined to estimate potential cumulative effects of erecting multiple facilities along the length of the Pacific Flyway.

23.7 EFFECTS OF ELECTROMAGNETIC FIELDS

Birds may be less susceptible to EMF emissions from underwater wave generators and cabling than are biota that spend their lives in the water. However, studies of birds on land show that bird behavior and reproductive success, growth, and development are affected by EMF (Fernie and Reynolds 2005). Land-based wind turbines have been shown to create substantial EMF emissions (Musial 2008). Most bird mortality and injury from land-based wind turbines is thought to occur from blade strike and pressure drops; however, little definitive work has been done in the area of EMF effects from offshore wind turbines.

23.8 SUMMARY AND DATA GAPS

The scarcity of empirical research on operational alternative energy systems represents a significant data gap in the analysis of likely impacts. Birds in the Northern Study Area may be directly affected by the presence of offshore wind platforms, wave buoys, and cables reaching shore through intertidal areas, as well as indirectly affected by changes in the marine food web and critical habitat.

Migratory seabirds and waterfowl are most at risk from striking surface structures, particularly during inclement weather and through attraction to lights on the structures. Noise from wind turbines, EMF from devices and cables, interruption of migratory pathways due to the physical presence of the structures, and accidental spills of petroleum-based lubricants and cooling fluids, all provide threats to migratory birds, including threatened and endangered species. Shorebirds and seabirds that nest and forage in shallow waters are at risk from EMF from cables traversing the nearshore; the same cables may damage portions of the shallow subtidal and intertidal areas that support shorebird prey. Changes in circulation and sediment transport may change lower levels of the marine food web, providing an additional stress for foraging shorebirds, marshbirds, and seabirds.

Future data collection efforts should be focused on evaluating and quantifying the effects of noise and EMF on a variety of seabirds, shorebirds, and marshbirds. Data are also needed to assist in the development of surface structures and lighting regimes that minimize migratory bird interactions and do not threaten migration pathways. Additional development is needed of tools that improve collision risk and probability models.

23.9 LIST OF LITERATURE CITED—BIRDS

- Boehlert, G.W., G.R. McMurray and C.E. Tortorici (eds.). 2008. Ecological effects of wave energy in the Pacific Northwest. U.S. Dept. of Commerce, NOAA Tech. Memo. NMFS-F/SPO-92, 174 pp.
- Desholm, M., A.D. Fox, P.D.L. Beasley and J. Kahlert. 2006. Remote techniques for counting and estimating the number of bird-wind turbine collisions at sea: A review. *Ibis* 148 (Supplement 1): 76-89 pp.
- DONG Energy, Vattenfall, The Danish Energy Authority and The Danish Forest and Nature Agency. 2006. Key Environmental Issues Danish Offshore Wind. Danish Energy Authority. 144 pp. Internet website: <http://ens.netboghandel.dk>. Accessed July 13, 2009.
- Drewitt, A.L. and R.H.W. Langston. 2006. Assessing the impacts of wind farms on birds. *Ibis* 148:29-42.
- Everaert, J. and E.W.M. Stienen. 2006. Impact of wind turbines on birds in Zeebrugge (Belgium). *Biodiversity and Conservation* 16(12):3345-3359.

- Fernie, K.J. and S.J. Reynolds. 2005. The effects of electromagnetic fields from power lines on avian reproductive biology and physiology: A Review. *Journal of Toxicology and Environmental Health* 8(2):127-140.
- Fox, A.D., M. Desholm, J. Kahlert, T.K. Christensen and I.K. Petersen. 2006. Information needs to support environmental impact assessment of the effects of European marine offshore wind farms on birds. *Ibis* 148:129-144.
- Garthe, S. and O. Hüppop. 2004. Scaling possible adverse effects of marine wind farms on seabirds: Developing and applying a vulnerability index. *Journal of Applied Ecology* 41(4):724-734.
- Gill, A.B. 2005. Offshore renewable energy: ecological implications of generating electricity in the coastal zone. *Journal of Applied Ecology* 42:605-615.
- Heubeck, M., K.C.J. Camphuysen, R. Bao, D. Humple, A.S. Rey, B. Cadiou, S. Braager, T. and Thomash. 2003. Assessing the impact of major oil spills on seabird populations. *Marine Pollution Bulletin* 48:900-902.
- Hüppop, O., J. Dierschke, K.M. Exo, E. Fredrich and R. Hill. 2006a. Bird migration studies and potential collision risk with offshore wind turbines. *Ibis* 148(s1):90-109.
- Hüppop, O., J. Dierschke, K-M. Exo, E. Fredrich and R. Hill. 2006b. Bird migration and offshore wind turbines. In: J. Koller, J. Koppel, and W. Peters, eds., *Offshore Wind Energy: Research on Environmental Impacts*. Springer, Berlin-Heidelberg. 91-116 pp.
- Hyrenbach, K.D. 2001. Albatross response to survey vessels: Implications for studies of the distribution, abundance, and prey consumption of seabird populations. *Marine Ecology-Progress Series* 212:283-295.
- Larsen, J.K. and M. Guillemette. 2007. Effects of wind turbines on flight behaviour of wintering common eiders: Implications for habitat use and collision risk. *Journal of Applied Ecology* 44(3):516-522.
- Michel, J., H. Dunagan, C. Boring, E. Healy, W. Evans, J. Dean, A. McGillis and J. Hain. 2007. Worldwide synthesis and analysis of existing information regarding environmental effects of renewable energy uses on the Outer Continental Shelf. U.S. Dept. of the Interior, Minerals Management Service. MMS OCS Report 2007-38.
- Musial, W. 2008. Status of wave and tidal power technologies for the United States. Tech Report. NREL/TP-500-43240.
- Stewart, G.B., A.S. Pullin and C.F. Coles. 2007. Poor evidence-base for assessment of windfarm impacts on birds. *Environmental Conservation* 34(01):1-11.

U.S. Dept. of Defense, Army Corps of Engineers. 2006. Cape Wind Energy Project, draft environmental impact statement. Internet website: <http://www.nae.usace.army.mil/projects/ma/ccwf/deis.htm>. Accessed July 13, 2009.

U.S. Dept. of the Interior, Minerals Management Service. 2007. Programmatic environmental impact statement for renewable energy development and production and alternate use of facilities on the Outer Continental Shelf. MMS OCS EIS/EA 2007-046.

Wiese, F.K. and G.J. Robertson. 2004. Assessing seabird mortality from chronic oil discharges at sea. *Journal of Wildlife Management* 68(3):11.

Wilson, B., R.S. Batty, F. Daunt and C. Carter. 2007. Collision Risks Between Marine Renewable Energy Devices and Mammals, Fish and Diving Birds. Report to the Scottish Executive. Scottish Association for Marine Science, Oban, Scotland. PA25 1QA. 110 pp.

24. MARINE MAMMALS

This evaluation of the impacts of alternative energy development focuses on pinnipeds and cetaceans with a coastal shallow-water distribution, since research from projects in other regions shows that most energy development impacts are localized (Koschinski et al. 2003; Madsen et al. 2006b). In the Northern Study Area, the species of greatest concern are: the harbor porpoise, killer whale, gray whale, as well as the following pinnipeds: harbor seal, California sea lion, Steller sea lion, and sea otter. Other species inhabit waters farther offshore and are less likely to be affected by nearshore development. These species include: the beaked whales, northern right whale, humpback whale, minke whale, sperm whale, Dall's porpoise, other offshore delphinids, elephant seal, and northern fur seal. There are seven marine mammal species in the Northern Planning Area that are listed as endangered: blue whales, fin whales, sei whales, humpback whales, Northern Pacific right whales, sperm whales and Southern Resident killer whales. Two species are listed as threatened: Steller sea lions and Guadalupe fur seals. The Washington stock of sea otters is not listed under the Federal ESA but is designated as Endangered by the State of Washington.

Alternative energy development and operations can involve a wide variety of activities that could have impacts on marine mammals. These include impacts of noise from seismic exploration, construction, operation, decommissioning, and vessel traffic. Other potential impacts could come from ship strikes, entanglements, chemical contamination, and obstruction. These are discussed in more detail in the sections below. Impacts to marine mammals from exposure to various sources of underwater noise on marine mammals has become a growing concern and area of study (Richardson et al. 1995; Evans 2003). Noise impacts focused on below are those that involve a specific type of sound source, and which affect marine mammal behavior. Some very loud sources of noise, primarily from seismic surveys, do have the potential to cause physical injury, however, these would likely only affect animals at very close range to the source. Physical injury from exposure to noise can include: (1) loss of hearing through temporary and permanent threshold shift (TTS and PTS), (2) damage to hearing organs, (3) damage to other body tissues, and (4) physical impacts of stress from exposure to sound (Evans 2003). Threshold levels for physical impacts have been developed for various species groups (Southall et al. 2007).

While many sources of noise are of greatest concern to marine mammals in close proximity to the source, there is evidence these impacts can potentially impact behavior at large distances. The noise generated by pile driving creates impact zones that may extend more than 100 km from the source, and perhaps as far as 1,000 km, based on the highest reported sound pressure levels and lowest measured transmission loss (Madsen et al. 2006b). This development may affect cetaceans that are particularly susceptible to low-frequency sound, including beaked whales and large baleen whales (Gordon et al. 2004; Fernandez et al. 2005; Barlow and Gisiner 2006; Cox et al. 2006; Macleod and D'amico 2006; Macleod et al. 2006). Studies on the effects of seismic surveys provide some insight into the potential effects on marine mammals (Mccauley et al. 2000; Richardson 2002; Gordon et al. 2004; Weller et al. 2006a; Weller et al. 2006b).

Cetaceans vocalize and detect sounds that they use for communication, orientation, predator avoidance, and feeding (Tyack et al. 2008). Large baleen whales generate low-frequency sounds that travel long distances; in some cases, they could potentially traverse ocean basins (Stafford et al. 1998). Most baleen whales produce sounds in the frequency of 10 Hz to 10 kHz (Richardson et al. 1995). Toothed cetaceans produce short, ultrasonic clicks for navigation and echolocation from 1 to 150 Hz (Richardson et al. 1995) and delphinid toothed cetaceans produce frequency-modulated whistles for communication (Tyack et al. 2008). Pinniped communication occurs in the frequency range of 50 Hz to 60 Hz (Richardson et al. 1995).

Most of the research on the effects of alternative energy development on marine mammals has been conducted on shallow-water species in European waters: harbor porpoise, and the harbor and gray seals (Dolman et al. 2003; Tougaard et al. 2003; Carstensen et al. 2006; Teilmann et al. 2006b; Teilmann et al. 2006a; Tougaard et al. 2006). In general, the operation of wind turbines is considered to have a low impact on the marine mammal species examined in European waters; the animals' behavior does not appear affected beyond 100 m from the turbine (Madsen et al. 2006b). The possibility of wind facilities placed in the migratory pathway of gray whales or killer whales has not been previously investigated. Data are not adequate to assess the impacts of larger, and potentially noisier, wind turbines than those tested in some of the European studies (Madsen et al. 2006b).

24.1 IMPACTS OF NOISE DURING DEVELOPMENT, OPERATION, AND DECOMMISSIONING

The development and operation of offshore alternative energy facilities involve many activities—profiling, pile driving, trenching and dredging, and vessel and helicopter traffic—that can cause noise-related problems (Hoffmann et al. 2000; Vella et al. 2001; Nedwell and Howell 2004; Madsen et al. 2006b). Other construction activities, such as cable laying, turbine and turbine tower installation, and offshore transformer installation, may also cause problems, but no noise measurements are available for these projects (Nedwell and Howell 2004).

For wind-facility development, numerous noise sources may affect marine mammals. The noise generated from the pile driving of foundations is of greatest concern because it generates high source-level signals in a broad bandwidth (Richardson et al. 1995; Nedwell and Howell 2004; Madsen et al. 2006b). The intense impulses from pile driving can disrupt marine mammal behavior many kilometers away; at close range, these sounds may cause hearing impairment (Madsen et al. 2006b). Gravitational concrete foundations do not require pile driving and would have much less impact on marine mammals during their construction (Madsen et al. 2006b; Dolman et al. 2007).

Researchers have documented the effects of noise from pile driving on harbor porpoises, harbor seals, and gray seals during the construction of two large projects off Denmark: the Nysted and Horns Reef wind facilities. Alterations to observed behavior and vocalizations were measured up to 15 km from the construction site during pile driving (Tougaard et al. 2003; Madsen et al. 2006b; Teilmann et al. 2006a; Teilmann et al. 2006b; Tougaard et al. 2006).

The pile driving affected harbor porpoises during the construction of the Nysted and Horns Reef facilities. Effects included dramatic changes in echolocation behavior and significant decreases in porpoise clicks relative to baseline levels (Henriksen et al. 2003; Carstensen et al. 2006; Tougaard et al. 2006). The detection of impacts was different between two regions: days of silence were noted after pile driving at Nysted in contrast to an effect that lasted hours at Horns Reef (Carstensen et al. 2006; Teilmann et al. 2006b; Tougaard et al. 2006). The researchers did not know whether the decrease in clicks occurred due to porpoise leaving the area or whether they ceased clicking. Nonetheless, the pile driving clearly affected the porpoises' behavior (Madsen et al. 2006b).

The surface behavior of the harbor porpoises also changed during the pile driving. The predominant behavior on days without pile driving was nondirectional swimming (presumably foraging); on days with pile driving, the porpoises swam directionally (i.e., traveling) (Tougaard et al. 2003). The researchers also documented changes in abundance and distribution for seals; fewer seals were observed at haul-out sites at Nysted and seals were absent from the waters surrounding the Horn Reef during this phase of construction (Teilmann et al. 2004; Teilmann et al. 2006a; Tougaard et al. 2006). Changes in activity levels returned to normal after pile driving ceased (Tougaard et al. 2003; Madsen et al. 2006b; Tougaard et al. 2006).

When impact zones are modeled for pile-driving operations, the sounds are audible to harbor seals and harbor porpoise at long distances. The calculated ranges are more than 100 km, and perhaps up to 1,000 km, using the highest reported sound pressure levels and the lowest measured transmission loss (Madsen et al. 2006b). At these distances, the impacts would extend to marine mammals in deeper waters, including those susceptible to low-frequency sounds such as beaked whales and baleen whales (Mccauley et al. 2000; Richardson 2002; Gordon et al. 2004; Barlow and Gisinier 2006; Cox et al. 2006; Macleod and D'amico 2006; Weller et al. 2006a; Weller et al. 2006b).

Construction activities that include dredging would also have impacts. During a project with constant dredging to keep a shipping channel open in a Baja lagoon, gray whales abandoned the lagoon for the years when this activity was in progress (Thomson and Johnson 1996). In experimental studies, bowhead whales in the Arctic stopped feeding at about 800 m from playback sounds and moved to areas more than 2 km away (Richardson et al. 1985).

Data on the effects of wind turbine operation on marine mammals are sparse. If any effects exist, they are considered minor and occur close to the turbines (Henriksen et al. 2003; Madsen et al. 2006b; Lucke et al. 2007; Lucke et al. 2008). The noise coming from wind turbine operations is low frequency (Nedwell and Howell 2004). The size of the impact zones from operating turbines depends on the hearing abilities of the species, sound propagation conditions, and presence of other noises such as vessel traffic (Madsen et al. 2006b). Theoretically, noise from turbine operation should affect harbor seals, which have hearing sensitive to these low frequencies (Henriksen et al. 2003; Madsen et al. 2006b).

Several studies suggest that harbor porpoise are unlikely to hear the noise produced by a wind turbine at distances beyond 100 m (Madsen et al. 2006b). Based on the noise levels of existing

turbines, the potential for masking would be limited to short ranges in the open sea, (Lucke et al. 2007). Larger and louder turbines could potentially prove more harmful (Madsen et al. 2006b). One study found that some harbor porpoise would be displaced permanently during operation (Hoffmann et al. 2000; Dolman et al. 2003).

Playback experiments simulating the noise of an offshore wind turbine were conducted with harbor seals and harbor porpoises (Koschinski et al. 2003). Findings showed that the behavior of both species was affected by turbine noise; the animals tended to surface at larger distances from the sound source during playback. The intervals between echolocation clicks increased significantly during the period of noise for harbor porpoises (Koschinski et al. 2003). While there is some debate over the techniques used in these experiments, the study demonstrated that the impact zone for harbor seals and harbor porpoises was fairly small (within a 60-200 m perimeter around the sound source) (Madsen et al. 2006b).

The impact of the operation's vibration and sound on whales remains unknown (Madsen et al. 2006b). Gray whales have a narrow migration route that runs quite close to shore; nearly the entire population migrates through the Northern Study Area during its winter southbound migration, and again in the spring traveling northward (Herzing and Mate 1984). The impacts that sound from the operation of alternative energy facilities would have on this species are unknown. If facilities were extensive, killer whales would also become a species of concern, for which the impacts are also unknown. Studies of noise at similar signals, but with higher levels than wind turbines, have shown avoidance responses by North Atlantic right whales and bowhead whales (Richardson et al. 1995; Nowacek et al. 2004). Assuming that whales may respond to noise from operating turbines at ranges up to several kilometers, therefore, seems reasonable (Madsen et al. 2006b).

While the actual processes that will be used to decommission alternative energy facilities remain unclear, it is generally thought that the impacts will be similar to those of the construction process (Nedwell and Howell 2004). The process to decommission concrete foundations could include the use of explosives (Nedwell and Howell 2004), which can be quite devastating on marine mammals given the potential of explosives to induce blast injury and acoustic trauma (Ketten 1995; Todd et al. 1996).

24.2 EFFECTS OF SEISMIC SURVEYS

The impact of the intense noise produced by marine seismic surveys on marine mammals—known for their acoustic sensitivity—is an issue of great concern (Richardson et al. 1995; Gordon et al. 2004; Nowacek et al. 2007). The primary biological repercussions of airgun noise on marine mammals are the physical/physiological effects and the disruptive impact of hazard avoidance on feeding, orientation, migration, and social behaviors (Richardson et al. 1995; Wartzok et al. 2003; Gordon et al. 2004).

While the hearing sensitivity of most baleen whales is unknown, researchers presume that it is similar to the frequencies of their vocalizations. Most energy produced by a seismic airgun falls in the range of 20 to 160 Hz; bowhead whales vocalize primarily at 25 to 400 Hz. Blue and fin whales produce sounds primarily at 10 to 60 Hz (Evans and Nice 1996; Evans 2002).

Some marine mammals are more susceptible to noise from airguns than others. Factors that make some species vulnerable include (Evans 2002):

- Species that vocalize using low-frequency sounds for communicating, navigating, and locating prey; these sounds potentially travel hundreds of miles.
- Whales with presumed hearing sensitivities that most directly overlap airgun sound frequencies (20-160 Hz).
- Endangered species, in particular, the North Pacific right whale (of which few exist) so little is known about their abundance or distribution (Brownell et al. 2001).
- Deep-diving species. In deep waters, sound may be more intense in specific water layers (e.g., the SOFAR channel) and transmitted for long distances (Evans 2002).
- Species with migration routes or feeding areas that overlap with areas planned for seismic exploration.

Most research on the impacts of airgun noise has been conducted on just two species (Richardson et al. 1995). While some variation occurs in the behavioral effects at different intensities, bottom types, and depth and distance from the noise, it is clear that marine mammals do react to airgun noise. In many cases, the animals' behavior (e.g., migration, feeding) is interrupted and they move away from the area of seismic activity. After the airgun noise has ceased, animals tend to return to the area. Gordon et al. (2004) summarized observations of behavior change in marine mammals in response to airguns.

While no bowhead whales live in the Northern Study Area, this species is probably the best studied in terms of seismic impacts due to the extensive amount of oil and gas exploration that has occurred in the Arctic (Reeves et al. 1984; Richardson et al. 1985; Ljungblad et al. 1988; Richardson et al. 1995; Richardson and Würsig 1997; Richardson 2002). Bowhead whales are relevant since they are closely related to North Pacific right whales. While it is not possible to study the impacts on this rare species directly, the effects on bowhead whales should be closely considered when evaluating the North Pacific right whales. Long-range avoidance was observed for migrating bowheads; they avoided airgun noise to more than 20 km where received levels were 120 to 130 dB re: 1 μ Pa rms (Richardson et al. 1999). Behavioral changes in blow rates and dive times were also observed (Richardson et al. 1995).

The other species that has been thoroughly studied for airgun impacts is the gray whale (Malme et al. 1983; Malme et al. 1986; Malme et al. 1987; Moore and Clarke 2002; Weller et al. 2006a; Weller et al. 2006b). Controlled studies on gray whales migrating along the California coast showed that animals exposed to airgun noise slowed and moved away (sound levels that caused avoidance by 10 percent, 50 percent, and 90 percent of the animals occurred at received levels of 164, 170, and 190 dB re: 1 μ Pa rms, respectively) (Malme et al. 1987; Gordon et al. 2004).

Changes in distribution and acoustic responses occurred during playback experiments in San Ignacio Lagoon, Mexico in 1985 (Dahlheim 1987; Schwarz 2002). Most whales abandoned the breeding lagoon, apparently in response to the noise, though the whales returned and regularly inhabited this area in subsequent years (Jones et al. 1994). Studies of western gray whales off Sakhalin Island, Russia found similar results, with animals abandoning feeding areas during seismic activity (Weller et al. 2006a; Weller et al. 2006b). These studies suggest that disruption of feeding behavior could have a major impact on this species (Weller et al. 2006b).

Researchers have also evaluated the impact of seismic activities on humpback whales (Malme et al. 1985; Mccauley et al. 2000; Au 2006), blue whales (McDonald et al. 1995), and sperm whales (Madsen et al. 2002; Madsen et al. 2006a; Miller et al. 2009). Very little research has been done on the impact of airguns on seals (Richardson et al. 1995; Harris et al. 2001).

There is debate on whether a seismic survey was responsible for the death of two Cuvier's beak whales in the Gulf of California in 2002 (Taylor et al. 2004; Cox et al. 2006). This survey was conducted with a powerful airgun array on the RV *Maurice Ewing*, a vessel possibly associated with a stranding of beaked whales in the Galapagos Islands in 2000 (Gordon et al. 2004). The uncertainties surrounding the beaked whale deaths exemplify the lack of understanding on the possible damage from airgun impulses.

24.3 EFFECTS OF VESSEL TRAFFIC

Two main concerns arise with the interaction of increased vessel traffic and marine mammals: greater disturbance by vessel noise and more collisions. Disturbances due to underwater vessel noise disrupt behaviors and increase the stress on animals. For pinnipeds, resting behavior at land haul-out sites can also be disturbed.

Several studies have reported short-term behavioral effects of vessel traffic on marine mammals (Au and Green 2000; Nowacek et al. 2001; Erbe 2002; Moore and Clarke 2002; Williams et al. 2002; Evans 2003; Buckstaff 2004; Foote et al. 2004; 2008; Jensen et al. 2008; Holt et al. 2009). Harbor porpoises are notoriously wary of boats; researchers have suggested increased vessel traffic as the cause of their disappearances from areas where they were once common, including Puget Sound, San Francisco Bay, the Baltic Sea, and the Wadden Sea (Leatherwood and Reeves 1983; Osborne et al. 1988). Low-frequency noise (5 to 500 Hz) from commercial shipping occurs throughout the world's oceans (Hildebrand 2005).

While little is known about the long-term impacts of vessel traffic on marine mammals, in two cases researchers have speculated that increased vessel traffic may have affected long-term gray whale distribution. Between 1975 and 1978, aerial surveys showed that about 60 percent of gray whales were using migration routes farther offshore than the coast routes they traveled previously (Dohl and Guess 1979). Between 1964 and 1983, seismic activity in this region was substantial (Malme et al. 1983), but many suggest increases in the noise and vessel traffic in this region as the cause (Rice 1965; Mate and Urbán-Ramirez 2003). The second case focused on gray whales feeding in Clayoquot Sound off Vancouver Island. A sequential shift in gray whale foraging farther away from the major whale-watching port of Tofino occurred over a three-year period (Duffus 1996). Until researchers determine if the whale-watching vessels contributed to

or were the causal factor in this gray whale distribution shift, Duffus suggests a risk-averse conservative management approach in regulating vessel traffic in gray whale feeding areas.

In addition to changes in distribution, gray whales in this study altered their vocalizations in response to outboard engine and oil-drilling sounds, such that four different measures of their calls were significantly higher than those measured under experimental conditions (Dahlheim 1987). Whales adapted their calls in response to the noise, essentially “shouting” and calling more frequently to counteract the higher noise levels.

Ship strikes by large vessels are a significant cause of mortality in some marine mammals species (Laist et al. 2001; Moore and Clarke 2002; Vanderlaan and Taggart 2007; Douglas et al. 2008). While injuries are most common with smaller vessels traveling slower than 14 kn, most lethal collisions occur with faster ships that exceed 80 m in length (Laist et al. 2001). Commercial vessels in the Southern Study Area travel to and from large ports in Long Beach, Los Angeles, and San Diego. In the Pacific, reports of large whales hit and killed by ships include gray whales, fin whales, humpback whales, sperm whales, blue whales, sei whales, and Baird's beaked whales (Douglas et al. 2008).

24.4 EFFECTS OF ENTANGLEMENT IN CABLES

Most types of alternative energy development require some use of cables and mooring lines to anchor structures, connect devices, and transmit power. While extensive literature on marine mammal interactions with these types of lines does not exist, entanglement in nets and buoy lines for crab and lobster gear has constituted a major source of mortality in cetaceans and is a major concern worldwide. A scientific workshop on the ecological effects of wave energy development in the Pacific Northwest identified mooring and the attendant cables as the biggest ecological threat to cetaceans (Boehlert et al. 2008). The primary concern is that cetaceans might strike them or become entangled. Additionally, gray whales might perceive large numbers of moorings as a barrier that could disrupt migration. Thin or slack cables that could easily entangle animals pose the most serious risk.

In the Pacific, harbor porpoises, harbor seals, gray whales, and humpback whales are the primary marine mammals killed by entanglement (Baird et al. 2002; Moore and Clarke 2002; Douglas et al. 2008). Most of these cases involve entanglement in nets, but both gray and humpback whales also became entangled in single lines from crab pots. Both humpback and right whales in the North Atlantic have become entangled in pot gear, most commonly in the buoy line that extends from the gear to the surface and next most commonly in the ground line that connects the pots to each other or the anchor to a pot (Johnson et al. 2005).

Several strategies have been recommended to reduce possible entanglement, including limiting the number of lines, avoiding slack lines, and using acoustical pingers (Boehlert et al. 2008). Acoustic pingers dramatically reduce the entanglement rates of many eastern North Pacific cetaceans (Barlow and Cameron 2003), including beaked whales in offshore drift gillnets off California (Carreta et al. 2008) and harbor porpoises in coastal gillnets off Washington (Gearin et al. 2000).

24.5 OTHER EFFECTS

Other possible impacts of alternative energy development on marine mammals include the effects of large stationary devices on marine mammal habitat, electric and magnetic fields, use of infrastructure as haul-out platforms, and the potential colliding of mammals with buoys in the water column.

One great uncertainty about alternative energy development in the Northern Study Area is the effect of the many large structures on the marine mammals, particularly gray whales that inhabit the continental shelf. Nearly the entire eastern North Pacific population of gray whales uses the migratory pathway each spring (March to May) and winter (December to January) (Herzing and Mate 1984). Whales tend to migrate farther offshore during the southbound migration compared to the northbound. The mean distance offshore off of the State of Washington was 15.7 miles for southbound animals compared to 7.3 miles during the northward migration.

Little is known about the impacts of electromagnetic fields to which marine mammals would be exposed (Dolman et al. 2007). Some researchers speculate that these fields may attract sharks, which might prove detrimental to some marine mammals, particularly dolphins and porpoises (Boehlert et al. 2008).

Pinnipeds will attempt to use infrastructure as haul-out habitat, particularly California and Steller sea lions (Boehlert et al. 2008). In Puget Sound, California and Steller sea lions used U.S. Navy platforms as haul-out sites. Up to 117 animals (84 California sea lions and 33 Steller sea lions) covered two 3.7 m x 2.7 m platforms (Steiger and Calambokidis 1986). This haul-out behavior not only damaged the platforms, but the noise from the sea lions forced the U.S. Navy to cease its acoustic operations. Numerous pinniped exclusion devices were attempted. A plan to use exclusion devices would prove necessary for any infrastructure potentially usable by pinnipeds as a haul-out platform.

Collisions with buoys or turbine blades on tidal generators in the water column could have long-term impacts on marine mammals, especially those that inhabit the shelf (Boehlert et al. 2008). While loud acoustic output from buoys could alert marine mammals to their presence, this noise could also disrupt feeding or migration (Boehlert et al. 2008).

Chemical contamination and exposure to marine mammals may also occur as a result of leaks or leaching of chemicals from platforms associated with alternative energy development (Boehlert et al. 2008). Leaks include oil from ships and hydraulic fluids from installations. These occurrences may be rare but could have consequences to marine mammals. Chemical exposure would be expected to occur more commonly but at much lower levels of exposure as a result of leaching from paints and anti-fouling compounds.

24.6 SUMMARY OF DATA GAPS

Although considerable research has taken place on some aspects of alternative energy development on marine mammals, especially in European waters, many data gaps still exist, especially in terms of wave energy, acoustic impacts, and species unique to the North Pacific.

Several studies have identified specific data gaps (Madsen et al. 2006b; Boehlert et al. 2008). These include:

- Site-specific baseline data on marine mammal species occurrence, distribution, and behavior. This information is critical to assess changes that might occur from interactions with alternative energy development.
- Site-specific acoustic effects of development on the species with sensitivity to low-frequency sounds, including harbor seals, baleen whales, and possibly harbor porpoises (Madsen et al. 2006b).
- Little is known about impacts on gray whales; this coastal species is likely to come into frequent contact with alternative energy development. Since this species occurs only in the North Pacific, it has not been included in studies in the North Atlantic or other waters off Europe where most research has been done. The Northern Study Area is not only a migration route for the entire eastern gray whale population, but also the feeding area for a small, but regular, component of this population (Calambokidis et al. 2002; Calambokidis et al. 2004). While the effects of seismic exploration have been examined for this species in the Arctic, this species would be susceptible to entanglements, noise, ship strikes and other vessel impacts, and habitat disturbance. The seasonally resident members of the population would face the cumulative effects to exposure to alternative energy sites.
- Several important data gaps related to acoustics and marine mammals still exist (Boehlert et al. 2008) including: (1) identifying what ambient sounds occur at the site of a potential wave energy facility; and (2) determining the hearing sensitivity of cetaceans and pinnipeds and how they respond to noise at frequencies generated by a wave energy buoy or buoy array.

24.7 LIST OF LITERATURE CITED—MARINE MAMMALS

- Au, W.W.L. 2006. Anthropogenic noise and baleen whales: A perspective from humpback whale acoustics., In: 151st Meeting of the Acoustical Society of America, Journal of the Acoustical Society of America. 119: 3402.
- Au, W.W.L. and M. Green. 2000. Acoustic interaction of humpback whales and whale-watching boats. *Marine Environmental Research* 49 (5): 469-481.
- Baird, R.W., P.J. Stacey, D.A. Duffus and K.M. Langelier. 2002. An evaluation of gray whale (*Eschrichtius robustus*) mortality incidental to fishing operations in British Columbia, Canada. *Journal of Cetacean Research and Management* 4 (3): 289-296.
- Barlow, J. and G.A. Cameron. 2003. Field experiments show that acoustic pingers reduce marine mammal bycatch in the California drift gill net fishery. *Marine Mammal Science* 19 (2): 265-283.

- Barlow, J. and R. Gisiner. 2006. Mitigating, monitoring and assessing the effects of anthropogenic sound on beaked whales. *Journal of Cetacean Research and Management* 7 (3): 239-249.
- Boehlert, G.W., G.R. McMurray and C.E. Tortorici. 2008. Ecological effects of wave energy development in the Pacific Northwest: a scientific workshop, October 11-12, 2007. U.S. Dept. of Commerce. NMFS-F/SPO-92. 174 Pp.
- Brownell, R.L., Jr, P.J. Clapham, T. Miyashita and T. Kasuya. 2001. Conservation status of North Pacific right whales. *Journal of Cetacean Research and Management (Special Issue)* 2: 269-286.
- Buckstaff, K.C. 2004. Effects of watercraft noise on the acoustic behavior of bottlenose dolphins, *Tursiops truncatus*, in Sarasota Bay, Florida. *Marine Mammal Science* 20 (4): 709-725.
- Calambokidis, J., J.D. Darling, V. Deecke, P. Gearin, M. Gosho, W. Megill, C. M. Tombach, D. Goley, C. Toropova and B. Gisborne. 2002. Abundance, range and movements of a feeding aggregation of gray whales (*Eschrichtius robustus*) from California to southeastern Alaska in 1998. *Journal of Cetacean Research and Management* 4 (3): 267-276.
- Calambokidis, J., R. Lumper, J. Laake, M. Gosho and P. Gearin. 2004. Gray whale photographic identification in 1998-2003: Collaborative research in the Pacific Northwest. Contract Report to the National Marine Mammal Laboratory, Seattle, WA.
- Carreta, J.V., J. Barlow and L. Enriquez. 2008. Acoustic pingers eliminate beaked whale bycatch in a gill net fishery. *Marine Mammal Science* 24 (4): 956-961.
- Carstensen, J., O.D. Henriksen and J. Teilmann. 2006. Impacts of offshore wind farm construction on harbour porpoise: acoustic monitoring of echolocation activity using porpoise detectors (T-PODs). *Marine Ecology Progress Series* 321: 295-308.
- Cox, T.M., T.J. Ragen, A.J. Read, E. Vos, R. W. Baird, K. Balcomb, J. Barlow, J. Caldwell, T. Cranford, L. Crum, A. D'amico, G. D'spain, A. Fernández, J. Finneran, R. Gentry, W. Gerth, F. Gulland, J. Hildebrand, D. Houser, T. Huller, P. D. Jepson, D. Ketten, C.D. Macleod, P. Miller, S. Moore, D.C. Mountain, D. Palka, P. Ponganis, S. Rommel, T. Rowles, B. Taylor, P. Tyack, D. Wartzok, R. Gisiner, J. Mead and L. Brenner. 2006. Understanding the impacts of anthropogenic sound on beaked whales. *Journal of Cetacean Research and Management* 7 (3): 177-187.
- Dahlheim, M E. 1987. Bio-acoustics of the gray whale (*Eschrichtius robustus*). PhD Dissertation, University of British Columbia. 315 pp.
- Dohl, T.P. and R. Guess. 1979. Evidence for increasing offshore migration of the California gray whale, *Eschrichtius robustus*, in Southern California, 1975 through 1978. In: Third Biennial Conference on the Biology of Marine Mammals, Seattle, WA.

- Dolman, S.J., M. Green and M.P. Simmonds. 2007. Marine Renewable Energy and Cetaceans, In: IWC Scientific Committee, IWC. SC/59/E10: 9 pp.
- Dolman, S.J., M.P. Simmonds and S. Keith. 2003. Marine Wind Farms and Cetaceans, In: IWC Scientific Committee, Unpublished paper to the IWC Scientific Committee. 18 pp. Berlin, May 2003. (SC/55/E4). IWC/SC/55/E4: 18 pp.
- Douglas, A.B., J. Calambokidis, S. Raverty, S.J. Jefferies, D.M. Lambourn and S.A. Norman. 2008. Incidence of ship strikes of large whales in Washington State. *Journal of the Marine Biological Association of the United Kingdom* 88 (6): 1121-1132.
- Duffus, D.A. 1996. The recreational use of gray whales in southern Clayoquot Sound, Canada. *Applied Geography* 16 179-190.
- Erbe, C. 2002. Underwater noise of whale-watching boats and potential effects on killer whales (*Orcinus orca*), based on an acoustic impact model. *Marine Mammal Science* 18 (2): 394-418.
- Evans, P.G.H. 2002. Biology of cetaceans of the North-east Atlantic (in relation to seismic energy), In: M. Tasker and C. Weir. *Proceedings of the Seismic and Marine Mammal Workshop*, London. Chapter 5: 35 pp.
- Evans, P.G.H. 2003. Shipping as a possible source of disturbance to cetaceans in the ASCOBANS region, In: 4th Meeting of the Parties, Esbjerg, Denmark. Sea Watch Foundation. Document MOP4/DOC17: 88.
- Evans, P.G.H. and H. Nice. 1996. Review of the effects of underwater sound generated by seismic surveys on cetaceans. Unpublished Report, Sea Watch Foundation, Oxford, England.
- Fernandez, A., J.F. Edwards, F. Redriquez, A.E. De Los Monteros, P. Herraiez, P. Castro, J.R. Jaber, V. Martin and M. Arbelo. 2005. "Gas and fat embolic syndrome" involving a mass stranding of beaked whales (Family *Ziphiidae*) exposed to anthropogenic sonar signals. *Veterinary Pathology* 42 (4): 446-457.
- Foot, A.D., R.W. Osborne and A.R. Hoesel. 2004. Whale-call response to masking boat noise. *Nature* 428 (6986): 910.
- Gearin, P.J., M.E. Gosho, J.L. Laake, L. Cooke, R.L. DeLong and K.M. Hughes. 2000. Experimental testing of acoustic alarms (pingers) to reduce bycatch of harbour porpoise, *Phocoena phocoena*, in the state of Washington. *Journal of Cetacean Research and Management* 2 (1): 1-10.
- Gordon, J., D. Gillespie, J. Potter, A. Frantzis, M.P. Simmonds, R. Swift and D. Thompson. 2004. A review of the effects of seismic surveys on marine mammals. *Marine Technology Society Journal* 37 (4): 16-34.

- Harris, R.E., G.W. Miller and W.J. Richardson. 2001. Seal responses to airgun sounds during summer seismic surveys in the Alaskan Beaufort Sea. *Marine Mammal Science* 17 (4): 795-812.
- Henriksen, O.D., J. Tougaard, L. Miller and R. Dietz. 2003. Underwater noise from offshore wind turbines: Expected impacts on harbor seals and harbor porpoises. In: *Environmental Consequences of Underwater Sound (ECOUS) Symposium*. San Antonio, Texas, 12-16 May 2003. Abstract only.
- Herzing, D.L. and B.R. Mate. 1984. Gray whale migrations along the Oregon Coast, 1978-1981. In: M.L. Jones, S.L. Swartz and S. Leatherwood, *The Gray Whale*. New York: Academic Press. 289-308.
- Hildebrand, J. 2005. Impacts of anthropogenic sound. In: J.E. Reynolds, II, W.F. Perrin, R.R. Reeves, S. Montgomery and T.J. Ragen, *Marine Mammal Research: Conservation Beyond Crisis*. Baltimore: Johns Hopkins Press. 101-123.
- Hoffmann, E., J. Astrup, F. Larsen, S. Munch-Petersen and J. Støttrup. 2000. Effects of marine windfarms on the distribution of fish, shellfish and marine mammals in the Horns Rev area. Unpublished Report, Danmarks Fiskeriundersøgelse Charlottenlund Report No. DFU-Rapport 117-02. 45 pp.
- Holt, M.M., D.P. Noren, V. Veirs, C.K. Emmons and S. Viers. 2009. Speaking up: Killer whales (*Orcinus orca*) increase their call amplitude in response to vessel noise. *The Journal of the Acoustical Society of America* 125 (1): EL27-EL32.
- Jensen, F.H., M. Wahlberg, L. Bejder and P.T. Madsen. 2008. Noise levels and masking potential of small whale-watching and research vessels around two delphinid species. *Bioacoustics* 17 166-168.
- Johnson, A., G. Salvador, J. Kenney, J. Robbins, S.D. Kraus, S. Landry and P.J. Clapham. 2005. Fishing gear involved in entanglements of right and humpback whales. *Marine Mammal Science* 21 (4): 636-645.
- Jones, M.L., S.L. Swartz and M.E. Dahlheim. 1994. Census of gray whale abundance in San Ignacio Lagoon: A follow-up study in response to low whale counts recorded during an acoustic playback study of noise-effects on gray whales. Report to Marine Mammal Commission. Washington, DC. 38 pp.
- Ketten, D. 1995. Estimates of blast injury and acoustic trauma zones for marine mammals from underwater explosions. In: R.A. Kastelein, J.A. Thomas and P. E. Nachtigall, *Sensory Systems of Aquatic Mammals*. Woerden: De Spil Publ. 391-407 pp.
- Koschinski, S., B.M. Culik, O.D. Henriksen, N. Tregenza, G. Ellis, C. Jansen and G. Kathe. 2003. Behavioural reactions of free-ranging porpoises and seals to the noise of a simulated 2 MW windpower generator. *Marine Ecology Progress Series* 265: 263-273.

- Laist, D.W., A.R. Knowlton, J. Mead, A.S. Collet and M. Podesta. 2001. Collisions between ships and whales. *Marine Mammal Science* 17 (1): 35-75.
- Leatherwood, S. and R.R. Reeves. 1983. *Sierra Club Handbook of Whales and Dolphins*. San Francisco: Sierra Club.
- Ljungblad, D.K., B. Wursig, S.L. Swartz and J.M. Keene. 1988. Observations on the behavioral responses of bowhead whales (*Balaena mysticetus*) to active geophysical vessels in the Alaskan Beaufort Sea [USA]. *Arctic* 41 (3): 183-194.
- Lucke, K., P.A. Lepper, M.A. Blanchet, B. Hovee, E. Everaarts, N. Van Elk and U. Siebert. 2008. Auditory studies on harbour porpoises in relation to offshore wind turbines. Report to the 15th ASCOBANS Advisory Committee Meeting. 4 pp.
- Lucke, K., P.A. Lepper, B. Hovee, E. Everaarts, N. Van Elk and U. Siebert. 2007. Perception of low-frequency acoustic signals by a harbour porpoise (*Phocoena phocoena*) in the presence of simulated offshore wind turbine noise. *Aquatic Mammals* 33 (1): 55-68.
- Macleod, C.D. and A. D'amico. 2006. A review of beaked whale behavior and ecology in relation to assessing and mitigating impacts of anthropogenic noise. *Journal of Cetacean Research and Management* 7 (3): 211-221.
- Macleod, C.D., W.F. Perrin, R. Pitman, J. Barlow, L. Ballance, A. D'amico, T. Gerrodette, G. Joyce, K.D. Mullin, D.L. Palka and G.T. Waring. 2006. Known and inferred distributions of beaked whale species (*Cetacea: Ziphiidae*). *Journal of Cetacean Research and Management* 7 (3): 271-286.
- Madsen, P.T., M. Johnson, P.J. O. Miller, N. Aguilar Soto, J. Lynch and P. Tyack. 2006a. Quantitative measures of air-gun pulses recorded on sperm whales (*Physeter macrocephalus*) using acoustic tags during controlled exposure experiments. *Journal of the Acoustical Society of America* 120 (4): 2366-2379.
- Madsen, P.T., B. Mohl, K. Nielsen and M. Wahlberg. 2002. Male sperm whale behaviour during exposures to distant seismic survey pulses. *Aquatic Mammals* 28 (3): 231-240.
- Madsen, P.T., M. Wahlberg, J. Tougaard, K. Lucke and P. Tyack. 2006b. Wind turbine underwater noise and marine mammals: Implications of current knowledge and data needs. *Marine Ecology Progress Series* 309 279-295.
- Malme, C.I., P.R. Miles, C.W. Clark, P. Tyack and J.E. Bird. 1983. Investigations of the potential effects of underwater noise from petroleum industry activities on migrating gray whale behavior. Final report for the period of 7 June 1982 - 31 July 1983 to U.S. Dept. of the Interior, MMS-Alaska OCS Office.
- Malme, C.I., P.R. Miles, P. Tyack, C.W. Clark and J.E. Bird. 1985. Investigation of the potential effects of underwater noise from petroleum industry activities on feeding humpback

- whale behavior. Contract Report to U.S. Dept. of the Interior, MMS-Alaska OCS Office. 205 pp.
- Malme, C.I., B. Wursig, J.E. Bird and P.L. Tyack. 1986. Behavioral responses of gray whales to industrial noise: Feeding observations and predictive modeling. Final Report to the U.S. Dept. of the Interior, MMS, OCS Assessment Program. 207 pp.
- Malme, C.I., B. Wursig, J.E. Bird and P.L. Tyack. 1987. Observations of feeding gray whale responses to controlled industrial noise exposure. In: Ninth International Conference on Port and Ocean Engineering Under Arctic Conditions, Fairbanks, Alaska. The Geophysical Institute, University of Alaska. 55-73 pp.
- Mate, B.R. and J. Urbán-Ramirez. 2003. A note on the route and speed of a gray whale on its northern migration from Mexico to central California, tracked by satellite-monitored radio tag. *Journal of Cetacean Research and Management* 5 (2): 155-157.
- Mccauley, R.D., J. Fewtrell, A.J. Duncan, C. Jenner, M.-N. Jenner, J.D. Penrose, R.I.T. Prince, A. Adhitya, J. Murdoch and K. McCabe. 2000. Marine seismic surveys-a study of environmental implications. *APPEA* 40:692-708.
- McDonald, M., J. Hildebrand and S.C. Webb. 1995. Blue and fin whales observed on a seafloor array in the northeast Pacific. *Journal of the Acoustical Society of America* 98 712-721.
- Miller, P.J.O., M.P. Johnson, P.T. Madsen, N. Biassoni, M. Quero and P.L. Tyack. 2009. Using at-sea experiments to study the effects of airguns on the foraging behavior of sperm whales in the Gulf of Mexico. *Deep-Sea Research*, doi:10.1016/j.dsr.2009.02.008
- Moore, S.E. and J.T. Clarke. 2002. Potential impact of offshore human activities on gray whales (*Eschrichtius robustus*). *Journal of Cetacean Research and Management* 4 (1): 19-25.
- Nedwell, J. and D. Howell. 2004. A review of offshore windfarm related underwater noise sources. Unpublished Report, Subacoustech LTD.
- Nowacek, D.P., M.P. Johnson and P.L. Tyack. 2004. North Atlantic right whales (*Eubalaena glacialis*) ignore ships but respond to alerting stimuli. *Proceedings of the Royal Society of London Series B Biological Sciences* 271 (1536): 227-231.
- Nowacek, D.P., L.H. Thorne, D.W. Johnston and P.L. Tyack. 2007. Responses of cetaceans to anthropogenic noise. *Mammal review* 37 (2): 81-115.
- Nowacek, S.M., R.S. Wells and A.R. Solow. 2001. Short-term effects of boat traffic on bottlenose dolphins, *Tursiops truncatus*, in Sarasota Bay, Florida. *Marine Mammal Science* 17 (4): 673-688.
- Osborne, R.W., J. Calambokidis and E.M. Dorsey. 1988. *A Guide to Marine Mammals of Greater Puget Sound*. Anacortes, WA: Island Publishers.

- Reeves, R.R., D.K. Ljungblad and J.T. Clarke. 1984. Bowhead whales and acoustic seismic surveys in the Beaufort Sea. *Polar Record* 22 (138): 271-280.
- Rice, D.W. 1965. Offshore southward migration of gray whales off Southern California. (*Eschrichtius robustus*). *Journal of Mammalogy* 46 (3): 504-505.
- Richardson, W.J. 2002. Marine mammals versus seismic and other acoustic surveys: Introduction to the noise issues. *Polarforschung* 72 (2-3): 63-67.
- Richardson, W.J., M.A. Fraker, B. Wursig and R.S. Wells. 1985. Behavior of bowhead whales, *Balaena mysticetus*, summering in the Beaufort Sea: Reactions to industrial activities. *Biological Conservation* 32 (3): 195-230.
- Richardson, W.J., C.R. Green, Jr., C.I. Malme and D.H. Thomson. 1995. Marine mammals and noise. San Diego: Academic Press. 576 pp.
- Richardson, W.J., G.W. Miller and C.R. Greene, Jr. 1999. Displacement of migrating bowhead whales by sounds from seismic surveys in shallow waters of the Beaufort Sea. *The Journal of the Acoustical Society of America* 106: 2281.
- Richardson, W.J. and B. Würsig. 1997. Influences of man-made noise and other human actions on cetacean behaviour. *Marine and Freshwater Behaviour and Physiology* 29 (1): 183-209.
- Schwarz, L.K. 2002. The impact of anthropogenic activities on the behavior of migrating eastern North Pacific gray whales (*Eschrichtius robustus*) M S Thesis, San Diego State University. 101 pp.
- Southall, B.L., A.E. Bowles, W.T. Ellison, J.J. Finneran, R.L. Gentry, C.R. Greene, Jr., D.A. Kastak, D.R. Ketter, J.H. Miller, P.E. Nachigall, W.J. Richardson, J.A. Thomas and P.L. Tyack. 2007. Marine mammal noise exposure criteria: initial scientific recommendations. *Aquatic Mammals* 33: 414-521.
- Stafford, K.M., C.G. Fox and D.S. Clark. 1998. Long-range acoustic detection and localization of blue whale calls in the northeast Pacific Ocean. *Journal of the Acoustical Society of America* 104: 3616-3625.
- Steiger, G.H. and J. Calambokidis. 1986. California and northern sea lions in southern Puget Sound, Washington. *Murrelet* 67: 93-96.
- Taylor, B., J. Barlow, R. Pitman, L. Ballance, T. Klinger, D. Demaster, J. Hildebrand, J. Urban, D. Palacios and J. Mead. 2004. A call for research to assess risk of acoustic impact on beaked whale populations. In: Scientific Committee at the 56th Meeting of the International Whaling Commission. 29 pp.
- Teilmann, J., J.D. Carstensen, R. and S.M.E. Edren. 2004. Effect on seals at Rodsand seal sanctuary from the construction of Nysted Offshore Wind Farm based on aerial surveys. Technical Report to Ministry of Environment, Denmark. 33 pp.

- Teilmann, J., J. Tougaard and J. Carstensen. 2006a. Summary on seal monitoring 1999-2005 around Nysted and Horns Rev Offshore Wind Farms. Technical Report to Ministry of Environment, Denmark.
- Teilmann, J., J. Tougaard and J. Carstensen. 2006b. Summary on harbour porpoise monitoring 1999-2006 around Nysted and Horns Rev Offshore Wind Farms. Final Report to Ministry of Environment, Denmark.
- Thomson, D.H. and S.R. Johnson. 1996. Effects of offshore oil development and production activities off Sakhalin Island and sea associated birds and marine mammals. Report to Marathon Oil, Houston, TX. 82 pp.
- Todd, S., P. Stevick, P. Lein, M. Fernanda and D. Ketten. 1996. Behavioural effects of exposure to underwater explosions in humpback whales (*Megaptera novaeangliae*). *Canadian Journal of Zoology* 74 (9): 1661-1672.
- Tougaard, J., J. Carstensen, O.D. Henriksen, H. Skov and J. Teilmann. 2003. Short-term effects of the construction of wind turbines on harbour porpoises at Horns Reef. Report to Techwise A/S, Roskilde.
- Tougaard, J., S. Tougaard, R.C. Jensen, T. Jensen, J. Teilmann, D. Adelung, N. Liebsch and G. Muller. 2006. Harbour seals at Horns Reef before, during and after construction of Horns Rev Offshore Wind Farm. Biological Papers from the Fisheries and Maritime Museum, Esbjerg, Denmark. 67 pp.
- Tyack, P., I. Boyd, D.E. Claridge, C.W. Clark, D. Moretti and B.L. Southall. 2008. Effects of sound on the behavior of toothed whales. In: *ACOUSTICS 2008*, 2923: (Abstract only).
- Vanderlaan, A.S.M. and C.T. Taggart. 2007. Vessel collisions with whales: the probability of lethal injury based on vessel speed. *Marine Mammal Science* 23 (1): 144-156.
- Vella, G., I. Rushforth, E. Mason, A. Hough, R. England, P. Styles, T. Holt and P. Thorne. 2001. Assessment of the effects of noise and vibration from offshore wind farms on marine wildlife. Report, University of Liverpool, Centre for Marine and Coastal Studies, Environmental Research and Consultancy.
- Wartzok, D., A.N. Popper, J. Gordon and J. Merrill. 2003. Factors affecting the responses of marine mammals to acoustic disturbance. *Marine Technology Society Journal* 37 (4): 6-15.
- Weller, D., S.H. Rickards, A.L. Bradford, A.M. Burdin and R.L. Brownell, Jr. 2006a. The influence of 1997 seismic surveys on the behavior of western gray whales off Sakhalin Island, Russia. In: International Whaling Commission, Paper SC/58/E4:12 pp.
- Weller, D.W., G.A. Tsidulko, Y.V. Ivashchenko, A.M. Burdin and R.L. Brownell, Jr. 2006b. A re-evaluation of the influence of 2001 seismic surveys on western gray whales off Sakhalin Island, Russia, In: International Whaling Commission, Paper SC/58/E5: 9 pp.

Williams, R., D.E. Bain, J.K.B. Ford and A.W. Trites. 2002. Behavioural responses of male killer whales to a "leapfrogging" vessel. . *Journal of Cetacean Research and Management* 4 (3): 305-310.

25. ECOSYSTEM INTERRELATIONSHIPS

There are few data on the potential effects of marine hydrokinetic energy farms and offshore wind parks on any portions of the ecosystem or food web. Therefore, it is difficult to assess the overall impacts these installations might have on the ecosystem (Gill 2005). The best estimate of impacts to the ecosystem in the Northern Study Area can be derived by examining probable impacts at each trophic level and then examining the linkages between the trophic levels and the surrounding environment.

The Boehlert et al. (2008) report represents the results of a workshop where 50 U.S. experts from a variety of fields gathered in order to 1) “develop an initial assessment of the potential impacting agents and ecological effects of wave energy development,” and 2) “formulate a general conceptual framework of physical and biological relationships that can be applied to specific wave energy projects.” The results of the workshop should be considered opinions of scientific experts, rather than statements of fact. In this document, statements referring to Boehlert 2008 are worded to indicate that they are potential impacts; where other scientific evidence is available, the original citation will be used.

25.1 CHANGES IN FOOD WEB PRODUCTION

Extraction of energy has the potential to alter the marine food web through changes in circulation or sediment transport; these changes may manifest as changing rates and patterns of phytoplankton growth, which will reverberate throughout the food web. Secondary producers will be affected by the availability of primary-produced food. As changes in primary and secondary production occur, carnivores, detritivores, and omnivores will change their feeding patterns accordingly (Frost 1993). Tertiary consumers such as juvenile fish, small marine fish, and carnivorous plankton like chaetognaths are generally not capable of switching prey, as are the large, more mobile organisms. Changes in the production of herbivorous zooplankton (due to changes in primary productivity) are likely to cause changes in the populations of small tertiary consumers (Mackas and Coyle 2005).

Effects on prey species at any step in the food web have the potential to alter and destabilize the entire food web. Alternative energy development impacts on fish or benthic organisms due to oil spills, habitat alteration, noise, or EMFs could have implications for other predator populations, eventually affecting other trophic elements. Although little research has been done to examine changes in food webs caused by the development and operation of offshore wind and hydrokinetic installations, lessons learned from other destabilizing influences, such as biological invasions of natural waters, provide worst-case scenarios such as the invasion of the Great Lakes by dreissenid mussels that have altered food webs, decimated fisheries, and changed water clarity (Conroy and Culver 2005). While no literature exists to tie the presence of alternative energy structures directly to successful invasions by nonnative species, the potential should be considered.

25.2 CHANGES IN PREDATION, COMPETITION, AND DISEASE

Boehlert et al. (2008) expert opinion proposed that surface structures such as wave buoys and offshore wind platforms are likely to attract fish, marine mammals, and birds; any surface or subsurface structure in an otherwise featureless water column will aggregate organisms. These aggregations will provide easier conditions for predators, and in many cases will benefit fish, bird, and marine mammal populations, as individuals will expend less energy catching their prey (Landry et al. 1993). The populations of most of the smaller organisms are likely to increase their production (most are *r* strategists) in response to increased predation, and their populations regionwide will not suffer. There are two possible major scenarios, however, under which the attraction to surface and subsurface platforms could potentially harm populations of small tertiary consumers such as juvenile salmon and small rockfish: (1) if alterations to the food web decrease the amount of primary and secondary production available for food, the organisms cannot increase production, and their populations will be diminished by higher-level consumers, further destabilizing the food web; and (2) if the populations of small tertiary consumers are threatened or depleted by other factors (such as endangered stocks of Pacific salmon or many coastal rockfish species), they will not be able to withstand increased predation from aggregation around structures, and their existence will be further threatened (Boehlert et al. 2008).

Aggregation around surface and subsurface structures could potentially allow for increased competition for food resources among organisms that are not generally found together, including members of the same family like various species of sharks (Boehlert et al. 2008). This increased aggregation could potentially allow for the spread of disease among organisms, although the strong flow of ocean water on the outer shelf should prevent disease outbreaks among pelagic organisms. Benthic organisms that establish themselves as biofouling on surface and subsurface structures, mooring lines, and anchors could potentially become a locus of disease to be transmitted to wild intertidal organisms or rafted aquaculture organisms. Introduction of pathogens from farmed to wild populations are largely anecdotal, but it is considered to be a viable threat among aquaculturists. Efforts to control biofouling should diminish this potential threat (Boehlert et al. 2008).

The presence of surface and subsurface platforms on the outer shelf has the potential to provide stepping-stones for invasive nonnative organisms along uninfected coastlines (Boehlert et al. 2008). The most likely candidates for using these platforms as islands for invasion are benthic forms established from planktonic larvae (Cohen and Carlton 1998).

25.3 SUMMARY AND DATA GAPS

Alternative energy installations may alter ecosystem relationships in several ways, although there is virtually no information available to support these conclusions. There is a possibility that changes to phytoplankton productivity due to energy removal from the system will reverberate through the food chain, changing overall productivity rates and species assemblages at all trophic levels. Similarly the effects of surface floats and other alternative energy infrastructure may lead to aggregation and avoidance behavior among fish, birds, marine mammals and large pelagic invertebrates. These behavioral changes may lead to altered patterns of competition, predation, or the spread of disease.

Additional information is needed to determine the impact that alternative energy structures will have on each level of the marine food web, and to determine how these changes will echo through the ecosystem. Similarly, studies of fish, birds, marine mammal, and large pelagic invertebrate behavior around alternative energy structures are needed, to support modeling of these interactions to determine their impact on patterns of competition, predation, invasion biology, and the spread of pathogens. The emerging field of biophysical coupling expands (e.g. synthesis of the River Influence on Shelf Ecosystems, or RISE by Hickey et al. 2010), has provided information about how factors such as subtle irreversible vertical mixing near the bottom in the vicinity of the Columbia River plume can influence productivity in the Pacific Northwest. Information is lacking on whether significant renewable energy infrastructure could alter this bottom mixing through scour or other process and lead to alterations in timing and/or amount of related productivity.

25.4 LIST OF LITERATURE CITED—ECOSYSTEM INTERRELATIONSHIPS

- Boehlert, G.W, G.R. McMurray and C.E. Tortorici (eds.). 2008. Ecological effects of wave energy in the Pacific Northwest. U.S. Dept. of Commerce, NOAA Tech. Memo. NMFS-F/SPO-92. 174 pp.
- Cohen, A.N. and J.T. Carlton. 1998. Accelerating invasion rate in a highly invaded estuary. *Science* 279:555.
- Conroy, J.D. and D.A. Culver. 2005. Do dreissenid mussels affect Lake Erie ecosystem stability processes? *American Midland Naturalist* 153(1):20-32.
- Frost, B.W. 1993. A modeling study of processes regulating plankton standing stock and production in the open sub-arctic Pacific Ocean. *Progress in Oceanography* 32(1-4):17-56.
- Gill, A.B. 2005. Offshore renewable energy: Ecological implications of generating electricity in the coastal zone. *Journal of Applied Ecology* 42:605-615.
- Hickey, B.M., R.M. Kudela, J.D. Nash, K.W. Bruland, W.T. Peterson, P. MacCready, E.J. Lessard, D.A. Jay, N.S. Banas, A.M. Baptista, E.P. Dever, P.M. Kosro, L.K. Kilcher, A.R. Horner-Devine, E.D. Zaron, R.M. McCabe, J.O. Peterson, P.M. Orton, J. Pan and M.C. Lohan. 2010. *Journal of Geophysical Research*, 115 CooB17, doi:10.1029/2009JC005452.
- Landry, M.R., D.J. Gifford, D.L. Kirchman, P.A. Wheeler and B.C. Monger. 1993. Direct and indirect effects of grazing by *neocalanusplumchrus* on plankton community dynamics in the sub-arctic Pacific. *Progress in Oceanography* 32(1-4):239-258.
- Mackas, D.L. and K.O. Coyle. 2005. Shelf-offshore exchange processes, and their effects on mesozooplankton biomass and community composition patterns in the northeast Pacific. *Deep Sea Research Part II: Topical Studies in Oceanography* 52:707-725.

26. AREAS OF SPECIAL CONCERN

The areas of special concern in the Northern Study Area most at risk from alternative energy siting and operation are the National Marine Sanctuaries. There is also a risk from potential transmission of invasive plants or animal larvae established on devices and platforms moving into the sanctuaries and possibly into national wildlife refuges and shoreline areas of national parks ([See Island Biogeography Theory Section in Chapter 11.3](#)).

Avoiding areas of special concern in siting energy development will minimize potential damage to sensitive areas like marine sanctuaries, national parks, wildlife refuges, sites of archeological importance, and research reserves and will also avoid the potential spread of contaminants from dumping sites used by the military (USDOI, MMS 2007).

The visual impacts of wave farms and offshore wind parks, and their potential conflicts with other beneficial uses of the marine environment have been raised in locations on the U.S. Atlantic Coast (USDOD, Army Corps Engineers 2006) and in the European Union (DONG Energy 2006). Concerns that have been raised include the visual impact of the surface structures from historical sites, as well as visual impacts for recreational boaters and kayakers; potential conflicts with historical marine sites including shipwrecks; and interference with tribal treaty rights for use of the marine environment. In most cases, wave farms and offshore wind parks planned for the United States and the European Union have been sited to avoid conflicts and visual impacts.

26.1 SUMMARY AND DATA GAPS

Even when areas of special concern are avoided in direct siting of alternative energy facilities, impacts to these areas are still possible if facilities are sited nearby to sensitive habitats, from changes in sedimentation, washing ashore of equipment during storms, and invasion by nonnative organisms taking refuge on alternative energy structures.

Data gaps exist in the inventory of existing resources within these Special Areas, as well as in the details of ecological processes taking place in those areas, so that future impacts can be measured and restoration activities planned.

26.2 LIST OF LITERATURE CITED—AREAS OF SPECIAL CONCERN

DONG Energy, Vattenfall, The Danish Energy Authority and The Danish Forest and Nature Agency. 2006. Danish Offshore Wind-- Key environmental issues. Danish Energy Authority. 144 pp. Internet website: http://193.88.185.141/Graphics/Publikationer/Havvindmoeller/havvindmoellebog_nov_2006_skrm.pdf.

U.S. Dept. of the Interior, Minerals Management Service (MMS). 2007. Programmatic Environmental Impact Statement for Alternative Energy Development and Production and Alternate use of Facilities on the Outer Continental Shelf. MMS OCS EIS/EA 2007-046.

U.S. Dept. of Defense, Army Corps of Engineers. 2006. Cape Wind Energy Project, Draft Environmental Impact Statement. Internet website:
<http://www.nae.usace.army.mil/projects/ma/ccwf/deis.htm>.

27. SOCIOECONOMIC IMPACTS

This synthesis evaluates information on some components of social, economic, and cultural concerns of offshore alternative energy development in the Northern Study Area. Currently, there are no operational offshore alternative energy installations in the Northern Study Area. Consequently, there are no monitoring and assessment studies of the socioeconomic impacts that occur as a result of the physical construction or operation of a project in the study area.

However, more than a dozen offshore alternative energy projects are at varying stages of development and planning, and a number of pilot-scale facilities have received permits. Potential wave energy project sites include Fort Bragg, Eureka, and Crescent City in California; Coos Bay, Newport, Astoria, and Westport in Oregon; and Neah Bay in Washington. Potential tidal energy project sites that have been identified include San Francisco Bay and Puget Sound. Moreover, the three states in the Northern Study Area—California, Oregon, and Washington—are environmentally conscious states that have placed themselves at the cutting edge of alternative energy development. For example, one of the actions of the *West Coast Governors' Agreement on Ocean Health Action Plan* (The Office of the Governors 2008) is to explore the feasibility for offshore alternative ocean energy development and evaluate the potential environmental impacts of these technologies. Further, the governments of all three West Coast states have set deadlines for utilities to produce a minimum percentage of electricity from renewable resources.

As a result of these government policies and proposed projects, there is a high level of public awareness of offshore alternative energy development in the Northern Study Area. Substantial information on public response to proposed offshore alternative energy projects is available from newspaper articles and other documents. A review of public attitudes toward and perceptions of planned offshore alternative energy development illustrates some fairly strong trends in public opinion. While the public is in favor of alternative energy in general, they have concerns about locating offshore alternative energy facilities in the region where they reside. These concerns and the public media attention they have received underscore the fact that socioeconomic effects on the human environment—real, empirically verifiable effects—can occur long before the first physical alteration of an offshore alternative energy project occurs.

An analysis of the information available on public attitudes toward and perceptions of planned installations reveals the following three general concerns that could slow the progress of offshore alternative energy development in the Northern Study Area:

- Lack of opportunities for public participation in project siting ([Section 27.1](#))
- Potential space-use conflicts ([Section 27.2](#))
- Uncertain jurisdiction over permitting ([Section 27.3](#))

Despite these constraints, offshore alternative energy development is being promoted in the Northern Study Area as an opportunity to attract new investment and create high-paying jobs, and States and coastal communities are moving ahead with plans and activities to position themselves as leaders in this emerging industry ([Section 27.4](#)). A synthesis of the available

information on the socioeconomic dimensions of these perceived constraints and opportunities is presented in the sections below. This discussion includes information needs for describing certain socioeconomic impacts of offshore alternative energy development.

There is a wide range of other areas of social, cultural, and economic interests to be considered in environmental assessments of offshore alternative energy installations. A number of additional areas of social, economic, and cultural concern are briefly summarized in [Section 27.5](#).

27.1 PUBLIC PARTICIPATION

A number of studies (Portman 2008) underline the importance of early consultation to involve the local community in the planning process for offshore alternative energy facilities. Stakeholder involvement in the earliest stages of the development of these facilities is critical in gaining public acceptance. As Conway et al. (2009) note, research and experience have shown that permitting processes rarely fail on technical or science grounds, but rather because of a failure to pay attention to the human dimension.

In some cases, opposition to proposed alternative offshore energy projects in the Northern Study Area developed because local citizens felt they had been ignored. The main factor that has contributed to this concern is the rapid Federal approval of large numbers of preliminary permits for proposed offshore alternative energy projects. The Federal Energy Regulatory Commission (FERC) has used its authority under the Federal Power Act to exercise jurisdiction over hydrokinetic (wave, tidal, current) ocean energy development through the issuance of preliminary permits for pre-licensing activities in coastal and offshore waters. This permit is valid for up to three years and gives the holder a priority status if the holder chooses to apply for a license. That is, the permit reserves a project location for the applicant while the holder conducts feasibility studies and prepares a license application (Lane 2007). In 2007, moreover, FERC issued a proposal to speed up the licensing process for wave and tidal energy pilot projects producing 5 MW or less power. Under the plan, a five-year license would be issued after a six-month review (Widman 2007).

In what some observers (Hartzell 2007; Hartzell 2008d) have likened to a gold rush, interested parties have used FERC preliminary permits to stake out claims to promising offshore alternative energy development sites throughout the Northern Study Area. At this point, for example, much of the Oregon coast has been claimed (Hartzell 2008e). And the scramble to stake claims has not been confined to private developers and public utilities; local governments, such as Lincoln County and Tillamook County, Oregon and Sonoma County, California have also applied for permits (Lincoln County Board of Commissioners 2006; Dillman 2007; Borges 2008; Federal Register 2008; Hansen 2008).

The proliferation of permitted offshore alternative energy proposals during the past few years demonstrates the keen interest in these projects despite pronounced engineering and technical challenges. However, newspaper columnist Frank Hartzell (2008e) notes: “The process has gone on largely under the radar, with some communities expressing surprise at discovering that their waters have been claimed under preliminary permits.” The aggressive development of

offshore alternative energy in a “fast-track” process by FERC has been criticized for occurring without significant public participation (Bacher 2008; Banse 2008).

The following example illustrates the challenges faced by offshore alternative energy proposals if public participation in project development is inadequate. In early 2007, Pacific Gas and Electric Company (PG&E) took the first step toward developing generation projects that could convert the abundant wave energy off the coast of Mendocino and Humboldt Counties (California) into electricity by filing two preliminary permit applications with FERC (Pacific Gas and Electric Company 2007). Collectively named “WaveConnect,” the proposed developments were applauded by industry proponents as one of the most important tests of the new technology in the nation. However, local reaction was overwhelmingly negative, mostly because of FERC’s lack of a public input process (Hartzell 2008h).

Mendocino County, the City of Fort Bragg, and Fishermen Interested in Safe Hydrokinetics (FISH Committee)—an alliance of commercial and recreational fishing associations—filed motions for late intervention in the proceedings for the Mendocino Project permit (USDOE, Federal Energy Regulatory Commission 2008a). In an explanation of why it chose to intervene, the Mendocino County Executive Office (2007) stated: “This action is urgently necessary and required because the proposed project is located geographically in the County’s ‘backyard,’ in the waters and on land adjacent to the County’s unparalleled and protectively developed coastline. While the County is certainly supportive of, and looks forward to, the possibility of a clean, renewable, energy source off its coastline, the potential for significant impacts to its coastal environment, its coastal communities and its economy, necessitates recognition of the County as a primary stake holder and participant.” However, the motions were denied by FERC on the grounds that they failed to show good cause for late intervention, and PG&E received a preliminary permit (USDOE, Federal Energy Regulatory Commission 2008c).

Mendocino County, Fort Bragg, and the FISH Committee then filed requests for a rehearing of the denial of their motions to intervene, and Mendocino County also requested a rehearing of the issuance of the permit (USDOE, Federal Energy Regulatory Commission 2008c). In response to comments by PG&E on Mendocino County’s request for rehearing, the County addressed the vagueness of PG&E’s description of the wave energy project (proposed project locations, number of wave energy converters) in the preliminary permit application and added that “the local community was denied both the opportunity to investigate the feasibility of a competing applications and a voice regarding the terms and execution of the permit itself” (Lkblog 2008). In 2008, FERC rejected the requests for rehearing (USDOE, Federal Energy Regulatory Commission 2008c).

In 2008, requests filed by Mendocino County, Lincoln County (Oregon), and the FISH Committee for a rehearing on FERC's proposed licensing policy for wave and tidal energy projects were also denied (Hartzell 2008i; Northern California Fishing Hunting and Outdoor News 2008; Ukiah Daily Journal Staff 2008). Under the Federal Power Act of 1920, as amended, there are no administrative appeals left and the only recourse is a lawsuit. Joining Mendocino County, Fort Bragg City Council has directed its city attorney to file a lawsuit against FERC (Hartzell 2008i).

The events above were accompanied by other forms of public protest. In 2008, for example, a public march and rally organized in Fort Bragg targeted FERC for denying local input into the wave energy study process off the Fort Bragg coast (Hartzell 2008j). Protestors called for a moratorium on wave energy permits until a process for local input could be devised (Hartzell 2008k). State and Federal agencies, as well as local communities, also argued that the proposed pilot licensing process under FERC was too rapid and prevented local input (Hartzell 2008a). California's Secretary of Resources sent a letter to FERC and the Department of the Interior's Minerals Management Service (MMS) stating that "...the process for permitting and licensing ocean energy development has raised significant concerns.... As the State agencies responsible for overseeing these projects, we are particularly concerned by conflicting Federal authorizations, the lack of a clear process to involve local governments and stakeholders and the potential that the process may not address all potential project impacts" (Hartzell 2008b). A letter to FERC sent by the National Marine Fisheries Service (NMFS) and National Ocean Service noted that "the issuance of conditioned licenses prior to completion of all requisite consultations and approvals would foster uncertainty and increase risk for project proponents" (National Marine Fisheries Service 2007).

There are also examples in the Northern Study Area of successful efforts to foster greater public participation in the planning process for offshore alternative energy development. In Oregon, for example, there has been a number of initiatives to expand local input in the planning process. In response to increased permitting of wave energy projects on the Oregon coast, the Governor's Office asked the Oregon Consensus Program to identify issues that may impact wave energy planning and policy development in Oregon and to assess opportunities for collaborative resolution of issues (Hampton 2008). The Oregon Consensus Program is the State's program to provide a neutral forum and expert assessment, mediation, and facilitation services to help public bodies and stakeholders resolve conflicts, make decisions, and develop public policy collaboratively and effectively across Oregon. The Oregon Consensus Program interviewed government agencies, coastal communities, the conservation community, utilities, and the fishing and wave energy industries to identify their views on wave energy development issues and summarized these views in a report (Hampton 2008).

In 2007, the Oregon Wave Energy Trust, a nonprofit organization charged with making Oregon a national leader in wave energy, was established by the Oregon Innovation Council with funds from the Oregon Legislature (Oregon Wave Energy Trust 2009a). The organization is designed to develop an integrated coastwide planning approach that engages local, State, and Federal stakeholders; promote the growth of wave energy and the subsequent economic benefits to the State; and provide outreach to the public (Anderson et al. 2007; Chambers 2008b). To help achieve its objectives the Oregon Wave Energy Trust put out a request for proposals in 2007 to begin to address many of the "human dimension" issues surrounding the development of wave energy off of the Oregon coast. Research grants were administered through a new research program created at Oregon State University. The result of this effort was a compendium of reports that examined the political and regulatory process, environmental, social and economic sustainability, and acceptability of wave energy projects (Conway 2009; Conway et al. 2009). In 2008 and 2009, the Oregon Wave Energy Trust hosted two-day wave energy conferences that

brought together professionals from around the world involved in the hydrokinetic industry to examine emerging technology, the economic benefits of the technology, community impacts, and other issues related to wave energy development (Chambers 2008b; Oregon Wave Energy Trust 2009b).

Industry-related user groups in Oregon have also promoted public participation. In 2008, the Southern Oregon Resource Coalition (SOORC), a coalition of marine-related interests on the south coast concerned about Oregon's coastal environments and communities, was organized (Chambers, 2008c). According to the coalition's website (Oregon International Port of Coos Bay 2009), "The founding members believe an informed and open dialogue between marine resource-dependent businesses and competing uses of open ocean resources is essential. SOORC serves as a forum to address issues of common interest to its members and associated industries through facilitation, engagement, and communication."

27.2 SPACE-USE CONFLICTS

27.2.1 Commercial and Recreational Fisheries

The primary space-use conflict issue associated with offshore alternative energy development in the Northern Study Area concerns the fishing industry. The opposition of commercial fishers is based on a fear of preemption of ocean space (Ram et al. 2004). For instance, the wave energy industry in Oregon, led primarily by two companies, seeks to put energy-generating buoys in the ocean in locations that fishermen also favor: sandy bottoms, at depths of between about 25 and 40 fathoms (Chambers 2007a). Buoys placed in 40 fathoms or deeper would have fewer impacts on crabbers, but may have more impacts on salmon trollers or groundfish trawlers (Chambers 2008a). Fishers' concerns about wave energy proposals have been heightened because Oregon and California have also been developing plans to cordon off areas of the ocean for marine reserves (Chambers 2007b; Profita 2007; Chambers 2008c; Chambers 2008a; Ross 2008).

Fishers believe that most wave energy devices will take up significant area and will likely be surrounded by an exclusion zone banning all fishing and vessel traffic (Martin 2007; Oregon Solutions 2007). Exclusion zones around wave energy installations are established for safety purposes because the devices have mooring systems that pose hazards to navigation and fishing. For example, there will be a fishing and navigation exclusion zone around the four-device demonstration project in Makah Bay (Washington) that will affect tribal crab and long-line commercial fishing and recreational fishing (Aquaenergy Group Ltd. 2005). There will also be a trawling exclusion zone along the submarine cable at Makah Bay (Aquaenergy Group Ltd. 2005). The Oregon Fishermen's Cable Committee (2009) and the telecommunications industry have already established procedures for trawling in the vicinity of submarine cables that are intended to protect the cables from being damaged by contact with trawl gear. Trawling over cables is not encouraged, and the procedures address how fishing vessels should operate when "near" cables to avoid contact.

Fishers in the Northern Study Area have organized in order to have a greater say in where wave energy devices would be placed in the ocean. In 2007, the Commissioners of Lincoln County (Oregon) established a 19-member advisory committee called Fishermen Involved in Natural

Energy (FINE) to develop a siting plan for wave energy projects off the Lincoln County shore and to review any applications made for those projects. The advisory committee provides commercial and recreational fishers with a unified voice in the wave energy siting process (Dillman 2007; Chambers 2009b). Also in 2007, the Fisherman's Advisory Committee for Tillamook (FACT), Oregon was formed by the Tillamook County Board of Commissioners to consult with the county on wave energy projects and other issues (Tillamook County Board of Commissioners 2007; Borges 2008). In 2008, the FISH Committee, an unincorporated association based in Fort Bragg, was organized based on the structure of FINE (Chambers 2008a). The organization is intended to represent the Mendocino County, California coastal fishing community, including fishermen, sea harvesters, fish processors, and other fishing-related businesses, in negotiations with wave energy companies as projects move forward (Fishermen Interested in Safe Hydrokinetics 2008; Hartzell 2008c).

In addition, the Pacific Coast Federation of Fishermen's Associations, the West Coast's largest commercial fishers' organization, has issued cautionary statements about offshore alternative energy development (Grader 2007). Similarly, the Pacific Fishery Management Council, a Federal organization tasked with managing and implementing laws governing fishing activity off the coasts of California, Oregon, and Washington, has raised concerns about the potential effects of wave energy projects, stating that fishing and fish habitat need to be protected (Pacific Fishery Management Council 2007; Driscoll 2008).

The Oregon State government has attempted to use face-to-face outreach and communication to seek views of the fishing industry (Chambers 2007c; Chambers 2007a). In addition, Oregon Governor Theodore Kulongoski has tried to defuse tensions in the fishing industry and coastal communities by agreeing to seek limits on the number of marine reserves and wave energy sites along the Oregon coast (Ross 2007; The Register-Guard 2007).

27.2.2 Visual Impacts

Experience with offshore alternative energy installations, especially wind park developments, has demonstrated that seascape and visual issues are often the most prominent reason for public objections (Michel et al. 2007). Construction and operation of an offshore alternative energy facility could potentially cause both onshore and offshore visual impacts. Offshore impacts associated with the development of offshore alternative energy facilities include the presence of the energy generation devices, navigational lighting on the devices, and marine vessels and helicopters for maintenance activities. Wind power will take up greater visual space than the above-water portions of wave and ocean current energy infrastructure. However, any loss in value due to visual disamenities may be partially counterbalanced by the benefits experienced by some individuals who may enjoy the sight of offshore wind turbines for aesthetic or symbolic reasons (e.g., perception of "green" power, perception of enhanced energy security) (National Research Council 2007; Weiss et al. 2007). Moreover, even if there is low public acceptance during the project proposal phase, acceptance levels may increase following construction, especially if feared impacts, such as declines in the tourist industry, do not materialize (Palmer 1997; Michel et al. 2007; National Research Council 2007).

A study of the preferences for the visual externalities of offshore wind farms among the population of Denmark showed that there is a significant willingness to pay for having wind farms located at distances where the visual disamenities are fairly small, i.e., up to 11 mi (18 km) from the shore (Ladenburg et al. 2005). There are not equally strong preferences—in terms of willingness to pay—for having wind farms moved further out to a distance of 31 mi (50 km) where they are virtually invisible from the shore. Similarly, a survey of tourists and residents conducted at four locations along the New Jersey shore found that the distance from shore was a key variable, with significant increase in approvals as distance from the shoreline increased (Lieberman Research Group 2006).

To date, there has been little concern in the Northern Study Area about potential visual/aesthetic impacts, probably because the location, number, and spacing of devices in full-scale installations have not been determined. Further, most of the existing wave and tidal energy technologies have a low profile that does not extend much above the water level (Ram et al. 2004; Michel et al. 2007).

27.2.3 Transportation and Navigation

Finally, depending on the location, number, array, and size of energy generating devices installed, offshore alternative energy facilities could potentially conflict with the rights of navigation enjoyed by marine users. For example, commercial shipping would be excluded from alternative energy facilities, and economic losses resulting from the diversion of navigation around energy facilities may arise (USDOJ, MMS 2007). Those adversely affected would be the owners or operators of ships and ports, their associated service businesses, and navigation agencies (United Kingdom Department of Business Enterprise and Regulatory Reform 2009). The locations of alternative energy facilities should be selected so as not to interfere with designated fairways and shipping lanes as well as prime fishing areas. However, this may be difficult if multiple alternative energy facilities were located close together, or if other facilities with similar exclusions were located close to the alternative energy facilities (USDOJ, MMS 2007). In addition to potentially interfering with designated fairways and shipping lanes, alternative energy development facilities could potentially interfere with airport flight paths and other controlled airspaces (USDOJ, MMS 2007).

27.3 ECONOMIC DEVELOPMENT

State and local governments in the Northern Study Area were quick to recognize that the potential benefits of offshore alternative energy development extend beyond the future generation of power at a lower cost than from existing sources (Lincoln County Board of Commissioners 2006). In particular, the emerging offshore alternative energy industry represents the potential for new job growth and economic development. Wage jobs are created in the testing and development of the wave energy devices, and more jobs are generated in manufacturing, servicing, and repair of the devices utilized in the wave parks at full build out (Lincoln County Board of Commissioners 2006).

As discussed in Minerals Management Service (2007), site-specific impacts of alternative energy facilities on employment and income would depend on the number of people employed during construction and operations, and on the size of the populations in the areas where facilities were

sited. In turn, the number, skill and pay level, and location of the jobs will vary depending upon the scale, location, and stage (e.g., construction, operation and maintenance, and decommissioning) of the project (National Research Council 2007).

In comparison with OCS oil and gas activities, low numbers of employees are required to operate alternative energy facilities. Although multiple alternative energy facilities in the same geographic region would employ larger numbers, these numbers would still be small and cumulative impacts may be negligible (USDOJ, MMS 2007). Nevertheless, the employment benefits to some localized areas, particularly rural or small urban areas with a limited economic base, may be substantial. For example, construction of the first of ten wave-energy buoys to be located off the coast of Reedsport, Oregon is expected to cost \$3 million to \$4 million and employ 30 workers from Oregon Iron Works in Clackamas County, Oregon (Weinstein 2009). Once production of the other buoys is started, another 150 jobs are expected to be created. This potential increase in employment opportunities is welcomed in an area that has experienced high losses in timber jobs and unemployment rates well above the state average (Weinstein 2009).

According to Flynn and Carey (2007), studies have shown that nearly 80 percent of the labor inputs required during the manufacturing and installation phase of an offshore wind energy farm will be needed for manufacturing the wind turbine generators. Consequently, while some of the jobs may be in the area that will host the alternative energy project, many others may be in a manufacturing plant several states away (National Research Council 2007).

Offshore installations require adequate industrial sites and port facilities for construction, operations, and ultimate decommissioning of the numerous individual generating units. The prospects of jobs and economic development has encouraged ports in the study area to compete with one another as a base for installation of offshore alternative energy facilities (Lincoln County Board of Commissioners 2006; Port of Olympia 2007; Hamner 2008; Newsom 2009). At the same time, the ports must consider the concerns of all the stakeholders involved; as Chambers (2008a) notes, ports interested in offshore alternative energy recognize that they also count on and support commercial fishing fleets.

In addition, competition among locales and institutions to be leaders in the development of wave energy technology is picking up in the United States and Canada (Tucker 2007). Researchers and entrepreneurs in Oregon, Washington, British Columbia, and Nova Scotia are among several regions competing to become centers of wave energy and develop the continent's first commercial wave energy project. For example, Oregon Governor Kulongoski has focused on establishing Oregon as a leader in alternative energy—wave energy in particular. In 2006, Governor Kulongoski designated Ocean Power Technologies proposal to develop a 2-MW wave energy project off Reedsport as an “Oregon Solutions” project—a designation that mobilized a community-based effort to support the project through collaboration among local government, businesses, nonprofit organizations, and the State (Kulongoski 2006). In addition, the governor allocated \$5.2 million in the State's 2007-09 budget proposal to support wave energy projects, including Oregon State University's effort to establish a national Ocean Wave Energy Research, Development, and Demonstration Center that will create and test wave energy technologies (Dillman 2007).

The University of Washington has also received large grants to conduct research on offshore alternative energy development. Whereas Oregon State University is focusing on wave energy research, the University of Washington's research efforts are centered on tidal energy development in Puget Sound (Ma 2008).

In 2008, the Northwest National Marine Renewable Energy Center was established, a U.S. Department of Energy-funded partnership between Oregon State University and the University of Washington. Center activities are structured to close key gaps in understanding through the support of baseline studies, on-going monitoring, and setting the technical, ecological, and human dimensions standards for wave energy projects; educate and mentor the next generation of marine energy-related scientists, engineers, and educators in the U.S.; facilitate device commercialization through development of standards for validation and evaluation of devices; inform regulatory and policy decisions; and inform and engage industry, science, and the public (Oregon State University 2010; University of Washington 2009). Funding for the center from various sources will total about \$13.5 million over five years (Oregon State University 2008).

The competition among states and communities to become leaders in the emerging alternative energy industry is likely to intensify due to the downturn in the United States economy and rising unemployment. Of particular importance will be obtaining a share of the Federal government stimulus funds appropriated under the American Recovery and Reinvestment Act of 2009, about \$120 billion of which are allocated to clean energy projects (Chambers 2009a; Malhotra 2009).

27.4 PUBLIC POLICY AND GOVERNANCE

There are multiple complexities and regulatory challenges within Federal, State, and local statutes. These complexities can create political conflicts and add to the governments' burdens and costs. A major source of conflict has been the jurisdictional disagreement between FERC and BOEMRE with respect to leasing and licensing offshore alternative energy projects (Elefant 2007; Chambers 2008e). There is no dispute that BOEMRE has permitting and development authority over wind power projects that use offshore resources beyond the three-mile limit of State waters (U.S. Dept. of the Interior and USDOE, Federal Energy Regulatory Commission 2009). However, both Federal agencies claim wave and tidal energy regulatory rights for areas past State waters (Hartzell 2008i; Hartzell 2008e). The jurisdictional dispute has been a source of aggravation for wind and wave energy developers from coast to coast and may have had an adverse effect on project development (Ram et al. 2004; Elefant 2007; Chambers 2008d; Hartzell 2008f; Lane 2008). In a broader perspective, the interagency conflict has bolstered concerns raised by some observers (Firestone et al. 2005) that offshore alternative energy development is among the emerging ocean uses that share a common problem and raise a common concern—policy regarding their use in U.S. waters is being formulated piecemeal, and they are developing in the absence of a coherent and publicly vetted policy framework.

In response to these concerns, the Department of the Interior and FERC announced in March 2009 that the two agencies intend to work together to facilitate the permitting of alternative energy in offshore waters (U.S. Dept. of the Interior and USDOE, Federal Energy Regulatory Commission 2009). On April 9, 2009, the two agencies signed an agreement that clarifies each

agency's jurisdictional responsibilities for leasing and licensing renewable energy projects on the OCS. Under the agreement, BOEMRE has exclusive jurisdiction with regard to the production, transportation, or transmission of energy from nonhydrokinetic alternative energy projects, including wind and solar. FERC will have exclusive jurisdiction to issue licenses for the construction and operation of hydrokinetic projects, including wave and tidal, but companies will be required to first obtain a lease through BOEMRE. The resolution of the FERC–BOEMRE dispute, together with a recently established regulatory process for granting leases, easements, and rights-of-way for offshore alternative energy development (USDOJ, MMS 2009a), is expected to reduce uncertainties for developers of offshore alternative energy projects. Guidance was jointly prepared by BOEMRE and FERC to clarify the implementation of agreement and the final regulations for projects requiring both an BOEMRE lease and a FERC license (USDOJ, MMS 2009b).

Conflicts have also emerged between Federal and State agencies. In 2008, the Washington Department of Ecology filed a petition with the U.S. Court of Appeals for the District of Columbia to protect the State's role in Federal licensing procedures for energy projects. The petition asks the court to clarify Federal law regarding a FERC decision to grant a conditioned license to Finavera Renewables to develop a wave energy project at Makah Bay off the Washington coast, superseding decisions from other Federal and State agencies with authority in the Federal licensing process (Washington Department of Ecology 2008).

FERC has pointed to Oregon as an example of successful State and Federal collaboration in offshore alternative energy development (Hartzell 2008a). In 2008, FERC and Oregon signed a memorandum of understanding designed to coordinate procedures and schedules for review of wave energy projects in State waters off the coast of Oregon (USDOE, Federal Energy Regulatory Commission 2008b). The MOU gives the State greater siting power over wave energy projects in the territorial sea (Chambers 2009b). In addition, the Oregon Consensus Program recommended a number of collaborative efforts to address State agency roles in wave energy decisions (Hampton 2008). Decisions of State and Federal agencies with respect to approvals of permits, licenses, leases or other authorizations to construct, operate, maintain, or decommission any renewable energy facility to produce, transport or support the generation of renewable energy within Oregon's territorial waters and ocean shore must comply with the requirements mandated in the Oregon Territorial Sea Plan (Oregon Coastal Management Program 2009).

California has also sought to exercise control over offshore alternative energy development off its coast. A State-commissioned white paper (Hackett 2008), prepared for the California Ocean Protection Council and the Public Interest Energy Research Program of the California Energy Commission, stated that tapping the ocean for power should be done carefully. The report noted that a review of existing information indicates significant gaps in our understanding of key economic and social tradeoffs involved in implementing wave energy conversion on a commercial or regional scale. In addition, recent events demonstrate the State's ability to both promote and dampen offshore alternative energy development. In 2008, for instance, the California Public Utilities Commission authorized Emerging Renewable Resource Program funding for PG&E to conduct feasibility and licensing work for its WaveConnect wave energy

project (Lkblog 2008; Public Utilities Commission of the State of California 2009). However, the California Public Utilities Commission rejected PG&E's request for approval of a renewable resource procurement contract with Finavera Renewables for a 2-MW project off Eureka due to concerns about economic feasibility (Hartzell 2008g; Public Utilities Commission of the State of California 2008).

As described previously, local governments have also expressed interest in taking an active part in initial site selection and screening for proposed offshore alternative energy installations. Counties have filed motions to intervene in the FERC permitting process, and in a further move to protect local control, some counties have applied for FERC permits covering the offshore areas along their coasts.

27.5 ADDITIONAL AREAS OF SOCIAL, CULTURAL, AND ECONOMIC INTEREST

There is a wide range of other areas of social, cultural, and economic interests to be considered in environmental assessments of offshore alternative energy installations. Because these areas have not been addressed in detail during this literature synthesis, they are briefly described below. Information needs for identifying and describing potential impacts are described in [Section 27.6](#).

27.5.1 Infrastructure and Services

Most wave and tidal energy developments would require standard-size port facilities to support construction and placement, so no modification of existing facilities is expected (USDOJ, MMS 2007). Vessel types and sizes to handle the equipment would also be “normal.” Depending on the location of the development site, port facilities may need to be expanded to accommodate the large components associated with wind facility development and the size and number of vessels required to transport components to their offshore/onshore locations (USDOJ, MMS 2007). Alternatively, larger but more distant ports could be used in the construction phase, but this would increase transportation distances, fuel costs, and construction time. Facilities to transport construction personnel both by boat and helicopter would also be needed. Onshore transportation to the point of embarkation of materials for construction would be required.

There are large port facilities along all the West Coast that could provide necessary construction support with minimal modification, and it is expected that any impacts associated with port and transportation system expansion would be negligible to minor.

27.5.2 Recreation and Tourism

The main recreation and tourism activities that could be affected by construction and operation of an offshore alternative energy facility would be sightseeing, diving, and recreational fishing. The extent of impacts would depend on the proximity of offshore alternative energy facilities and activities to recreational use areas. These impacts can be negative, such as increased vessel traffic, exclusion areas, and visual effects, and positive, such as enhanced recreational fishing opportunities for certain species that are attracted by the introduction of hard substrates.

Another possible impact on tourism and recreation associated with offshore alternative energy development in the Northern Study Area involves surfing. Wave energy installations have the potential to reduce wave energy in the lee of the installation, thereby negatively affecting the quality of surfing areas (Kim and Douglass 2007; Ram et al. 2004; Reynolds 2005). The Oregon chapter of the Surfrider Foundation has stated that wave energy project sites should not impact or overlap with priority surfing and other ocean recreation areas (Surfrider Foundation 2008). On the other hand, the potential to reduce wave height has been identified as a benefit for vessels transiting to and from harbor entrances, allowing for safer passage. Further, the reduced impact on breakwaters may allow for longer survival of these structures, and the reduced sediment transport may reduce the accretion of sand bars near the mouths of harbors (Largier 2008). In any case, OCS wave energy development is likely to have negligible impacts on wave height in the surf zone because the facilities would be located some distance offshore.

27.5.3 Human Health and Safety

Industrial accidents associated with offshore alternative energy development could result in both injuries and fatalities to workers. The hazards during construction and operation of offshore alternative energy facilities are similar to those of most large industrial facilities and infrastructure projects (USDOJ, MMS 2007). The hazards are physical hazards and include working at heights, working on or over water, in confined spaces, or with machinery, and being in the vicinity of falling objects. The risks from industrial hazards depend on the magnitude, location, and characteristics of the specific project, health and safety planning and training, and adherence to established regulations and safety and accident prevention and control measures.

Under authority established in the Outer Continental Shelf Lands Act and pursuant to a memorandum of understanding between the two agencies, the BOEMRE and Coast Guard (USCG) regulate safety on fixed OCS facilities. The BOEMRE regulates the structural integrity of fixed OCS facilities, and the USCG regulates marine systems, such as lifesaving, navigation equipment, and workplace safety and health. In February 2002, the USCG issued a final regulation that authorized the BOEMRE to perform inspections on fixed facilities engaged in OCS activities on their behalf and to enforce USCG regulations applicable to those facilities. The Outer Continental Shelf Lands Act also requires that the BOEMRE and Coast Guard investigate major accidents, deaths, serious injuries, major fires, and major spillages, as well as lesser accidents.

27.5.4 Military Use Areas

Offshore alternative energy facilities would vary in size and location but may be large enough to create a substantial exclusion area for military uses. For example, the ocean area occupied by a commercial wind facility could be about 26 km² (10 mi²) (USDOJ, MMS 2007). Such impacts to military uses would be additive if more than one alternative energy facility were located in a fairly small geographic area. In addition, even if not restricting military uses, there may be potential adverse effects on radar operations from the presence of operating wind turbine generators—the rotor height of a wind turbine generator may exceed 122 m (400 ft) (USDOJ, MMS 2007; U.S. Dept. of Defense 2006). However, impacts to military operations are expected to be negligible as long as developments are coordinated with the U.S. Department of Defense.

27.6 AVAILABLE INFORMATION & DATA GAPS

27.6.1 Commercial and Recreational Fisheries

During environmental assessments of individual sites for proposed offshore alternative energy development, it often has been difficult to obtain quantitative data for evaluation of the potential impact on fisheries. The most successful projects used early and open communications with stakeholders. Gray et al. (2005) conducted an important analysis of the interaction among the fishing industry, the wind energy park industry, and regulators. The researchers showed how critical a comprehensive and early stakeholder process is for management of development. For example, the fishing industry can influence site choice by identifying areas that were least valuable, thus minimizing the loss of what they consider to be the most profitable areas.

The significance of space-use conflicts can be assessed, in the case of commercial fisheries, by examining the spatial and temporal nature of fishing activities. Databases maintained by the Pacific States Marine Fish Commission (PSMFC) are useful in this respect. The Pacific Fisheries Information Network (PacFIN) provides timely and accurate data essential for effective fisheries management. The PacFIN central database includes fish-ticket and vessel registration data provided by the Washington, Oregon, and California State fishery agencies. In addition, State fishery agencies supply species catch composition and catch by area proportions that are developed from their port sampling and trawl logbook data systems. Groundfish catches are supplied by species, gear type, and area. Ex-vessel per pound prices are provided also by species and gear type along with revenue estimates. The spatial resolution of these data is typically the geographical management unit. Finer spatial resolution, ten by ten degree blocks, subject to confidentiality constraints, can be obtained by submitting a custom data request to the PacFIN database manager. The Fisheries Economics Data Program, also maintained by the PSMFC, is useful in conducting such an assessment because it is responsible for conducting annual industry cost and effort surveys.

The West Coast Groundfish Observer Program, operated by the National Marine Fisheries Service's Northwest Fisheries Science Center, places observers on commercial fishing vessels to monitor and record catch data, including species composition of retained and discarded catch. The objective of this program is the provision of accurate accounts of total catch, bycatch, and discards associated with different fisheries and fish stocks.

Taken together, the above data sources facilitate evaluation of the potential impacts of offshore alternative energy development on commercial fisheries. While these data sets contain extensive information on catch, there are limited data on fishing effort, catch per unit of effort, and harvesting costs, both spatially and temporally. Research to address these data deficiencies would improve the ability to evaluate the impacts of alternative energy activities.

With respect to recreational fisheries, spatial conflicts can be assessed using the Pacific Recreational Fisheries Information Network (RecFIN) database. California, Oregon, Washington, and NMFS contribute to the database maintained by the PSMFC. RecFIN is designed to integrate State and Federal marine recreational fishery sampling efforts into a single database that provides data on catch, effort, economics, and fisher demographics. To meet the

objectives of the program, the Washington Department of Fish and Game conducts an Ocean Sampling Program to monitor private/rental and for-hire fishing boats along its coast. The Oregon Department of Fish and Wildlife conducts the Ocean Recreational Boat Survey (ORBS) to monitor private and charter boat fishing in the Pacific Ocean. The ORBS is based on an onsite exit-count survey of fishing effort and a port-based access-point-intercept survey that collects catch per unit of effort data from boat operators. The California Department of Fish and Game conducts an onsite survey of effort and an access-point-intercept survey for catch per unit of effort data. Other survey methods include a license-based angler directory telephone survey of effort, an onsite survey of pier/dock fishing, and access-point-intercept surveys to collect catch per unit of effort data from angler and boat operators.

The Marine Recreational Fisheries Statistics Survey (MRFSS) generates independent estimates of effort and catch through two separate survey components, a bimonthly household telephone survey, and a continuous onsite, access-point-intercept survey of angler fishing trips. RecFIN expands on this coastwide overview of marine recreational catch and effort to incorporate all State and Federal sampling programs into an integrated system. In the Pacific MRFSS, an average of 40,000 anglers is interviewed each year at fishing sites upon completion of their trip. Data on species caught, lengths and weights, various demographics and trip activity data and economic data are collected from each angler. About six separate state data collection projects are conducted, with sampling levels of up to 20 percent of the angler trips targeted on specific fisheries and fishing modes in specific areas. These state data are integrated with MRFSS data by RecFIN to provide coastwide marine recreational catch and effort data for use by State and Federal fishery agencies and the public. As with the PacFIN data, finer resolution data sets can be obtained from the RecFIN database manager.

Environmental Impact Statements and Environmental Assessments produced for Pacific Fishery Management Council management proposals contain a wealth of information that can be coupled with the databases discussed above to support the assessment of alternative energy development projects. While there is an abundance of spatial and temporal catch information in the environmental reviews prepared by the council and NMFS, catch per unit of effort and cost information is sparse. This deficiency limits the use of these documents in examining potential fisheries impacts of offshore alternative energy development.

A tool that may be useful for data collection and analysis is Open OceanMap, developed by Ecotrust. Using a web-based interface, Open OceanMap allows analysts to collect and compile ecological and economic data through an intuitive stakeholder interview process (Ecotrust 2009). The survey results can then be incorporated into spatial and economic analyses. Ecotrust used this geographic information system technology to help to estimate potential fishery impacts of proposed marine protected area networks developed in California's Marine Life Protection Act process (Scholz et al. 2008; Steinback & Kruse 2009).

27.6.2 Visual Resources and Aesthetics

Description of the visual resources potentially affected by proposed offshore alternative energy development involves establishing landscape types and scenic quality in the areas in which energy facilities would be located, followed by an assessment of the potential sensitivity to

changes in the visual environment, including the likely number of viewers. Visual impact assessments will need to be conducted for selected viewpoints that include historic properties and onshore recreational sites (mostly beaches) and offshore sites. These assessments should include field surveys to collect information on seascape quality, sensitivity, value, and capacity to accommodate change of these viewpoints. In addition, computer-generated simulations and photomontages can illustrate how the facility would appear under different conditions. Guidance documents (Department of Trade and Industry 2005; National Research Council 2007) have been developed on how to address seascape and visual impacts during environmental reviews for offshore wind parks, and the methods presented in these documents could also be used to address seascape and visual impacts of wave and tidal energy projects.

27.6.3 Transportation and Navigation

Assessment must be conducted to determine if areas selected for development impact existing water and air navigation or transportation routes. For water navigation, collection of marine traffic data in the vicinity of a proposed project could include current activity by military craft (Navy and Coast Guard); commercial business craft (freighters, tug boats, fishing vessels, ferries, and cruise passenger ships); commercial recreational craft (cruise ships and fishing/sight-seeing charters); research vessels; and personal craft (fishing boats, house boats, yachts, and other pleasure craft). Possible data sources of marine traffic in the vicinity of a proposed project include Vesseltracker.com (2009). Information on the types of navigation hazards that offshore alternative energy development may pose is available from collision incident data collected by the USDO, MMS (2008).

Impacts to commercial and recreational boating would be addressed through a full navigation risk assessment, often coordinated with the U.S. Coast Guard. Tuholski et al. (2002) describe a standard approach to risk assessment, which seeks to identify hazards as sources of risks and then examines how the hazards might give rise to accidents. Accidents are categorized both in terms of the severity of their effects (i.e., consequences in terms of harm to people or the environment, damage to assets, and other economic losses) and the likelihood of the harm occurring. In addition, mitigation measures to reduce risks to more acceptable levels are identified.

In 2007, the USDOD, Coast Guard (2007) issued *Navigation and Vessel Inspection Circular No. 02-07*, which provides guidance on information and factors the Coast Guard considers when reviewing applications for permits to build and operate an offshore alternative energy facility in the navigable waters of the United States. The circular identifies information that the Coast Guard considers when evaluating the potential impacts of an offshore alternative energy facility in the areas of navigational safety and the traditional uses of waterways and on Coast Guard missions. The Coast Guard will provide an evaluation of the potential impacts of the proposed facility on the safety of navigation and the traditional uses of the particular waterway and other Coast Guard missions.

A general air navigation concern is associated with tall structures. For example, there could be siting concerns relative to the locations of airports and flight patterns and air space associated with the airports because of the turbines and meteorological towers located at offshore wind energy projects. The Federal Aviation Administration (FAA) will review potential impacts to air

navigation for structures greater than 200 ft (61 m) in height above sea level. Another FAA criterion triggering a notice of proposed construction is whether the project would be located within 20,000 ft (6,096 m) or less of an existing public or military airport (depending upon the type of airport or heliport). If the potential site for an offshore alternative energy development project is known, an internet database such as AirNav.com can be searched online to obtain this information. Inputting the geographic coordinates allows identification of public, private, and military airports; balloon ports; glider ports; heliports; seaplane bases; short takeoff and landing airports (STOLports); and ultralight flight parks within a minimum radius of 6 mi (10 km) to a maximum of 200 mi (322 km).

27.6.4 Economic Development

As discussed above, in comparison with OCS oil and gas activities, low numbers of employees are required to operate alternative energy facilities. Nevertheless, the number of jobs created from any offshore alternative energy development is of primary importance to a state, county, or city (Michel et al. 2007). In addition to direct employment impacts, employment may be indirectly created through secondary economic effects, including indirect impacts (e.g., changes in interindustry purchasing patterns) and induced impacts (e.g., changes in household spending patterns). Input-output models, such as IMPLAN, an economic input-output software package and data set developed by MIG, Inc., can be used to estimate total job creation including multiplier impacts of a proposed project at different scales. The IMPLAN input-output model also provides other measures of economic activity, such as output (dollars' worth of production) and regional income (the sum of worker wages and salaries plus business income and profits).

In addition, in the late 1990s, BOEMRE developed a new framework for estimating regional economic impacts that recognizes regional differences but provides for a consistent approach to the development of models for all coastal areas and for different levels of analysis (Coffman et al. 2009; Dismukes et al. 2003). Contractors for the BOEMRE subsequently created the MAG-PLAN (BOEMRE Alaska-Gulf of Mexico Modeling using IMPLAN) economic model, a Microsoft ACCESS-based, two-stage input-output model using IMPLAN multipliers, to estimate employment, personal income, and similar economic impacts from OCS activities. In the broadest terms, MAG-PLAN consists of two stages and requires an Exploration & Development (E&D) scenario to run. E&D scenarios are estimates of the OCS activities that are likely to occur as the result of a proposed action such as a lease sale or collection of lease sales. The first stage of MAG-PLAN estimates the level of spending (by sector and location), and the second stage uses IMPLAN multipliers to convert the spending into estimates of employment, personal income, etc. (Coffman et al. 2009).

Also useful may be the Jobs and Economic Development Impacts (JEDI) Wind Model, an input-output model developed for the National Renewable Energy Laboratory specifically to estimate the economic benefits from a new wind energy facility (Goldberg et al. 2004). Like IMPLAN, the JEDI Wind model calculates direct, indirect, and induced economic impacts in terms of jobs, wage and salary income, and output both during the construction period and during the operating years.

27.7 LIST OF LITERATURE CITED—SOCIOECONOMIC IMPACTS

- Anderson, F., G. Achterman, S. Padula and M. Harte. 2007. A programmatic approach to wave energy planning: Opportunities for the Oregon Wave Energy Trust, Coastal Zone 07, Portland, OR.
- Aquaenergy Group Ltd. 2005. Scoping Document Two: Makah Bay Offshore Wave Energy Pilot Project. Mercer Island, WA,
- Bacher, D. 2008. Wave Energy Development: What are the impacts to fish and other marine life? North Coast. January 2, 2009. <http://www.indybay.org/newsitems/2008/08/03/18522428.php>.
- Banse, T. 2008. Released Some coastal towns need persuading to embrace wave energy. Seattle, WA: KUOW News. 2008.
- Borges, R. 2008. Sea energy stirs wave of interest. Headlight-Herald. June 24:Tilamook, OR. <http://tillamookheadlightherald.com/main.asp?Search=1&ArticleID=9740&SectionID=8&SubSectionID=&S=1>.
- Chambers, S. 2007a. Questions mark wave energy meeting. The World. June 15:Coos Bay, OR. <http://nl.newsbank.com/nl-search/we/Archives>.
- Chambers, S. 2007b. Wave energy worries fishermen. The World April 10:Coos Bay, OR. <http://nl.newsbank.com/nl-search/we/Archives>.
- Chambers, S. 2007c. Fishing conversation cordial with Gov. The World. November 2:Coos Bay, OR. <http://nl.newsbank.com/nl-search/we/Archives>.
- Chambers, S. 2008a. Fishermen question need for buoys. The World. January 17:Coos Bay, OR. <http://www.theworldlink.com/articles/2008/01/17/news/doc478fa06c1fa33089502875.txt>.
- Chambers, S. 2008b. Why the Oregon Coast? Conference on wave energy begins today. The World. September 25:Coos Bay, OR. <http://theworldlink.com/articles/2008/09/25/news/doc48dbc99361570947524130.txt>.
- Chambers, S. 2008c. Fishermen seek more input on wave energy. The World. September 29:Coos Bay, OR. <http://theworldlink.com/articles/2008/09/29/news/doc48e10b1f397c3400618492.txt>.
- Chambers, S. 2008d. State, feds grapple with rules for ocean energizers. The World. September 26:Coos Bay, OR. <http://theworldlink.com/articles/2008/09/26/news/doc48dd1afde5bc9570070292.txt>.
- Chambers, S. 2008e. Wave energy regulatory war brews. The World. October 18:Coos Bay, OR. <http://nl.newsbank.com/nl-search/we/Archives>.

- Chambers, S. 2009a. Wave energy company hopes for federal money. The World. February 3:Coos Bay, OR. <http://www.theworldlink.com/articles/2009/02/03/news/doc49888c0493b1e525108794.txt>.
- Chambers, S. 2009b. Feds OK wave energy at Newport. The World. February 3:Coos Bay, OR.
- Coffman, K., V. Zatarain and S. Gambino. 2009. The New Regional Economic Impact Modeling Approach for the U.S. Dept. of the Interior, Minerals Management Service.
- Conway, F. 2009. Science Informing Policy: The Human Dimension of Wave Energy. 2009 Ocean Renewable Energy Conference IV, Seaside, OR.
- Conway, F., M. Stefanovich, J. Stevenson, Y. Yin, H.V. Campbell, D. Hunter and Z. Covell. 2009. Science and Knowledge Informing Policy and People: The Human Dimensions of Wave Energy Generation in Oregon. Northwest National Marine Renewable Energy Center, Oregon State University. Corvallis, OR.
- Department of Trade and Industry, United Kingdom. 2005. Guidance on the assessment of the impact of offshore wind farms: Seascape and visual impact report.
- Dillman, T. 2007. Commissioners appoint new fishermen's wave energy advisory group. Newport News Times. March 2: Newport, OR. <http://latimesblogs.latimes.com/lanow/2008/04/state-says-yes.html>.
- Dismukes, D., W. Olatubi, D. Mesyanzhinov and A. Pulsipher. 2003. Modeling the Economic Impacts of Offshore Oil and Gas Activities in the Gulf of Mexico: Methods and Applications. New Orleans, LA. Dept. of the Interior, MMS, OCS Study MMS 2003-018.
- Driscoll, J. 2008. Fishery managers worry about wave energy projects. The Times-Standard. June 26:Eureka, CA. http://www.times-standard.com/ci_9697745?IADID=Search-www.times-standard.com-www.times-standard.com.
- Ecotrust. 2009. Open OceanMap. December 18, 2009. <http://www.ecotrust.org/ocean/OpenOceanMap.html>.
- Elefant, C. 2007. MMS-FERC Jurisdictional smackdown! Renewables offshore. September 25, 2008. http://carolynelefant1.typepad.com/renewablesoffshore/2007/02/mmsferc_jurisdi.html.
- Federal Register. 2008. Green Wave Energy Solutions, LLC; Notice of Application accepted for filing and soliciting motions to intervene, protests, and comments. U.S. Government Printing Office. Project No. 13047-000.
- Firestone, J., W. Kempton, A. Krueger and C. Loper. 2005. Regulating offshore wind power and aquaculture: Messages from land and sea. Cornell Journal of Law and Public Policy 14 (1): 71-111.

- Fishermen Interested in Safe Hydrokinetics. 2008. Motion For Late Intervention: FERC Project No. 12779-000, Pacific Gas and Electric Company (PG&E), Application for preliminary permit for the Humboldt WaveConnect Project, FERC Notice of Application accepted for filing and soliciting motions to intervene, protests, and comments Issued April 17, 2007. Fort Bragg, CA,
- Flynn, R. and R. Carey. 2007. The potential economic impact of an offShore wind farm to the State of South Carolina.
- Goldberg, M., K.C. Sinclair and M. Milligan. 2004. Job and Economic Development Impact (JEDI) Model: A User-Friendly Tool to Calculate Economic Impacts from Wind Projects.
- Grader, Z. 2007. Statement of W.F. “Zeke” Grader, Jr., Executive Director Pacific Coast Federation of Fishermen’s Associations before the House Resources Committee Subcommittee on Fisheries, Wildlife & Oceans and the Subcommittee on Energy & Minerals Resources Regarding “Renewable energy opportunities and issues on the Continental Shelf”. Fishermen's News. June:San Francisco, CA. <http://www.pcffa.org/fn-jun07.htm>.
- Gray, T., C. Haggett and D. Bell. 2005. Offshore wind farms and commercial fisheries in the U.K.: A study in stakeholders consultation. *Ethics, Place & Environment* 8 (2): 127-140.
- Hackett, S. 2008. Economic and social considerations for wave energy development in California. In: *Developing wave energy in Coastal California: Potential socioeconomic and environmental effects*. California Energy Commission, PIER Energy-Related Environmental Research Program and California Ocean Protection Council.
- Hamner, E. 2008. Wave energy firm makes pitch to port. *The World*. January 19:Coos Bay, WA. <http://www.theworldlink.com/articles/2008/01/19/news/doc4791a14364547254258889.txt>.
- Hampton, T. 2008. Oregon Coast wave energy statewide policy and planning assessment: Summary of comments and recommendations. Portland State University. Portland, OR
- Hansen, S. 2008. Water agency eyes wave energy. *Sonoma News*. January 12: Sonoma, CA. <http://www.sonomanews.com/articles/2008/01/12/news/doc477958605c5d2837745746.txt>.
- Hartzell, F. 2007. San Francisco moves to block wave energy. *Fort Bragg Advocate News*. July 20: Fort Bragg, CA. <http://nl.newsbank.com/nl-search/we/Archives>.
- Hartzell, F. 2008a. Wave-power proposals alarm locals. *The Christian Science Monitor*. March 4: Boston, MA. <http://nl.newsbank.com/nl-search/we/Archives>.
- Hartzell, F. 2008b. Top state official asks feds for better wave energy process. *Fort Bragg Advocate News*. May 22: Fort Bragg, CA. <http://nl.newsbank.com/nl-search/we/Archives>.
- Hartzell, F. 2008c. Fishing group forms to address wave energy. *Fort Bragg Advocate News*. February 14: Fort Bragg, CA. <http://nl.newsbank.com/nl-search/we/Archives>.

- Hartzell, F. 2008d. Fort Bragg is ground zero in wave energy fight. Fort Bragg Advocate News. October 23: Fort Bragg, CA. <http://nl.newsbank.com/nl-search/we/Archives>.
- Hartzell, F. 2008e. Hydrokinetic Permits Abound Despite Objections. Renewable Energy World.com. <http://www.renewableenergyworld.com/rea/news/article/2008/02/hydrokinetic-permits-abound-despite-objections-51672>.
- Hartzell, F. 2008f. PG&E dumps MMS wave process, county to sue FERC. Fort Bragg Advocate News. September 4: Fort Bragg, CA. <http://nl.newsbank.com/nl-search/we/Archives>.
- Hartzell, F. 2008g. State expresses doubts about wave energy viability in rejecting Eureka funding. Fort Bragg Advocate News. October 16: Fort Bragg, CA. <http://nl.newsbank.com/nl-search/we/Archives>.
- Hartzell, F. 2008h. Wave energy backer booed at meeting. Fort Bragg Advocate News. May 1: Fort Bragg, CA. <http://nl.newsbank.com/nl-search/we/Archives>.
- Hartzell, F. 2008i. City initiates a suit against FERC. Fort Bragg Advocate News. September 11: Fort Bragg, CA. <http://nl.newsbank.com/nl-search/we/Archives>.
- Hartzell, F. 2008j. Marchers call for wave moratorium. Fort Bragg Advocate News. April 3: Fort Bragg, CA. <http://nl.newsbank.com/nl-search/we/Archives>.
- Hartzell, F. 2008k. Wave energy blogger plans local march. Fort Bragg Advocate News. March 27: Fort Bragg, CA. <http://nl.newsbank.com/nl-search/we/Archives>.
- Kim, V. and E. Douglass. 2007. PG&E to get watts from waves. Los Angeles Times. December 19: Los Angeles, CA. <http://articles.latimes.com/2007/dec/19/business/fi-wave19>.
- Kulongoski, T. 2006. Governor announces support for nation's first commercial wave energy project. Press Release. http://www.oregon.gov/Gov/p2006/press_100206.shtml.
- Ladenburg, J., A. Dubgaard, L. Martensen and J. Tranberg. 2005. Economic valuation of the visual externalities of offshore wind farms.
- Lane, N. 2007. Issues affecting tidal, wave, and in-stream generation projects. Congressional Research Service Library of Congress. Washington, D.C.
- Lane, N. 2008. Wave, tidal, and in-stream energy projects: which Federal agency has the lead? Congressional Research Service Library of Congress. Washington, D.C.
- Largier, J. 2008. The potential impact of WEC development on nearshore and shoreline environments through a reduction in nearshore wave energy. In: Developing wave energy in coastal California: Potential socioeconomic and environmental effects. California Energy Commission, PIER Energy-Related Environmental Research Program and California Ocean Protection Council.

- Lieberman Research Group. 2006. New Jersey Shore opinions about offshore wind turbines.
- Lincoln County Board of Commissioners. 2006. Lincoln County wave energy power project. Lincoln County Board of Commissioners. Newport, OR
- Lkblog. 2008. CPUC offers only partial funding to PG&E wave energy. Mendo Coast Current. December 12, 2008. <http://mendocoastcurrent.wordpress.com>.
- Ma, M. 2008. Concerns emerge about environmental effects of wave-energy technology. Seattle Times. November 17: Seattle, WA. <http://nl.newsbank.com/nl-search/we/Archives>.
- Malhotra, R. 2009. San Francisco mayor asks feds for permission on major wave energy project. The Inspired Economist. March 30, 2009. <http://inspiredeconomist.com>.
- Martin, J. 2007. Wave energy projects threaten North Coast fisheries. The Fish Sniffer. September 30, 2007. <http://www.fishsniffer.com/guest/071117waveenergy.html>.
- Mendocino County Executive Office. 2007. Mendocino County files motion to intervene regarding PG&E's Mendocino WaveConnect Project. Mendocino County Executive Office. Ukiah, CA
- Michel, J., H. Dunagan, C. Boring, E. Healy, W. Evans, J. M. Dean, A. McGillis and J. Hain. 2007. Worldwide synthesis and analysis of existing information regarding environmental effects of alternative energy uses on the Outer Continental Shelf. U.S. Dept. of the Interior, Minerals Management Service, Environmental Studies Program. Herndon, VA MMS OCS Report 2007-038.
- National Research Council. 2007. Environmental impacts of wind-energy projects.
- Newsom, G. 2009. Wave energy to bring power and jobs to San Francisco. March 30, 2009. <http://cleantechnica.com/2009/02/27/wave-energy-to-bring-power-and-jobs-to-san-francisco.com>.
- Northern California Fishing Hunting and Outdoor News. 2008. FERC denies angler appeal for wave energy rehearing. EasyWriter. September 30, 2008. http://www.myoutdoorbuddy.com/fishing_hunting_water_report.php?water=58
- Oregon Coastal Management Program. 2009. Territorial Sea Plan. Part Five: Uses of the Territorial Sea. A. For the Development of Renewable Energy Facilities or Other Related Structures, Equipment or Facilities. December 26, 2009. http://www.oregon.gov/LCD/OCMP/docs/Ocean/otsp_5.pdf.
- Oregon Fishermen's Cable Committee. 2009. Procedures to follow while operating near submarine fiber optic cables. <http://www.ofcc.com/procedures.htm>. March 27, 2009.
- Oregon International Port of Coos Bay. 2009. Southern Oregon Ocean Resource Coalition. March 30, 2009. www.portofcoosbay.com/soorc.htm.

- Oregon Solutions. 2007. Reedsport Wave Energy Project crabbing and fishing issues. March 30, 2009. http://www.orsolutions.org/docs/3-8_crab-fish.pdf.
- Oregon State University. 2008. Oregon Selected for Northwest Marine Renewable Energy Center. Media Release. January 11, 2009. <http://oregonstate.edu/dept/ncs/newsarch/2008/Sep08/waves.html>.
- Oregon State University. 2010. Northwest National Marine Renewable Energy Center: Home. January 11, 2010. <http://nnmrec.oregonstate.edu/>.
- Oregon Wave Energy Trust. 2009a. About the Oregon Wave Energy Trust. <http://www.oregonwave.org/index.php/about-us.html>. March 30, 2009.
- Oregon Wave Energy Trust. 2009. 2009b. Ocean Renewable Energy Conference IV, Seaside, OR.
- Pacific Fishery Management Council. 2007. Re: Reedsport OPT Wave Energy Park (FERC No. 12713). Pacific Fishery Management Council. Portland, OR
- Pacific Gas and Electric Company. 2007. PG&E to study wave power in Humboldt & Mendocino. News Release. http://www.pge.com/about/news/mediarelations/newsreleases/q1_2007/070228.shtml.
- Palmer, J. 1997. Public acceptance study of the Searsburg Wind Power Project: Year One post-construction.
- Port of Olympia. 2007. Wind energy cargo discharged at port. May 3, 2009. <http://www.portolympia.com/whatnew/press/2007>.
- Portman, M. 2008. Involving the public in the impact assessment of offshore renewable energy facilities. *Marine Policy* 33 (2): 332-338.
- Profita, C. 2007. Wave energy projects crash into ocean fishing turf; storm clouds gather as ocean users compete for priority. *The Daily Astorian*. November 19: Astoria, OR. <http://nl.newsbank.com/nl-search/we/Archives>.
- Public Utilities Commission of the State of California. 2008. Energy Division Resolution E-4196. Public Utilities Commission of the State of California. Sacramento, CA.
- Public Utilities Commission of the State of California. 2009. Application of Pacific Gas and Electric Company and San Diego Gas & Electric Company for approval of their Separate emerging renewable resource programs. Public Utilities Commission of the State of California. Sacramento, CA.
- Ram, B., R. Thresher, N. Fall and R. Bedard. 2004. Wave power in the U.S.: Permitting and jurisdictional issues. Electric Innovation Institute, Global Energy Partners LLC, and EPRI.

- Reynolds, C. 2005. Power play. Los Angeles Times. February 15:Los Angeles, CA. <http://articles.latimes.com/2005/feb/15/news/os-waves15>.
- Ross, W. 2007. Governor moves to limit reserves, wave energy sites. The Register-Guard. November 2:Eugene, OR. <http://nl.newsbank.com/nl-search/we/Archives>.
- Ross, W. 2008. Cautious reception for wave proposal. The Register-Guard. November 8:Eugene, OR. <http://nl.newsbank.com/nl-search/we/Archives>.
- Scholz, A., C. Steinback, S. Kruse, M. Mertens and M. Weber. 2008. Commercial and recreational fishing grounds and their relative importance off the North Central Coast of California. Ecotrust. Portland, OR.
- Steinback, C. and S. Kruse. 2009. Overview of fisheries uses and values project in support of the Marine Life Protection Act (MLPA) Initiative (North Coast Study Region). Ecotrust. Portland, OR.
- Surfrider Foundation. 2008. Statement on wave energy in Oregon. San Clemente, CA.
- The Office of the Governors. 2008. West Coast Governors' agreement on Ocean Health Action Plan.
- The Register-Guard. 2007. Don't limit coast options. The Register-Guard. November 7:Eugene, OR. <http://nl.newsbank.com/nl-search/we/Archives>.
- Tillamook County Board of Commissioners. 2007. Minutes. Tillamook County Board of Commissioners. Tillamook, OR. August 22, 2007.
- Tucker, L. 2007. Oregon faces setbacks in race to lead world in wave energy. Daily Journal of Commerce. November 30:Portland, OR. http://www.djcoregon.com/searchArticles.cfm?q=Oregon+faces+setbacks+in+race+to+lead+world+in+wav&meta_author=&req_meta_date_start=&req_meta_date_end=&sort=date%3AD%3AS%3Ad1.
- Tuholski, N., H. Gluver, C.A. Cornell, B. Gerwick and R. Patev. 2002. Risk assessment procedures for innovative navigation projects.
- U.S. Dept. of Commerce, National Marine Fisheries Service. 2007. Re: Hydrokinetic conditioned license policy. Silver Spring, MD.
- U.S. Dept. of Defense, Coast Guard. 2007. Navigation and Vessel Inspection Circular No. 02-07. Washington, D.C.
- U.S. Dept. of Defense, Office of the Director of Defense Research and Engineering. 2006. Report to the Congressional Defense Committees: The effect of windmill farms on military readiness. U.S. Dept. of Defense, Office of the Director of Defense Research and Engineering. Washington, D.C.

- U.S. Dept. of Energy, Federal Energy Regulatory Commission. 2008a. Requests for rehearing by fishermen interested in safe hydrokinetics (FISH Committee). Federal Energy Regulatory Commission. Washington, D.C.
- U.S. Dept. of Energy, Federal Energy Regulatory Commission. 2008b. FERC, Oregon signs memorandum of understanding for wave energy projects. <http://www.ferc.gov/news/news-releases/2008/2008-1/03-27-08.asp>. March 3, 2009.
- U.S. Dept. of Energy, Federal Energy Regulatory Commission. 2008c. Order on Rehearing.
- U.S. Dept. of the Interior and U.S. Dept. of Energy, Federal Energy Regulatory Commission. 2009. Interior and FERC announce agreement on offshore renewable energy development. U.S. Dept. of the Interior and Federal Energy Regulatory Commission.
- U.S. Dept. of the Interior, Minerals Management Service (MMS). 2007. Programmatic Environmental Impact Statement for alternative energy development and production and alternate use of facilities on the Outer Continental Shelf. U.S. Dept. of the Interior, Minerals Management Service. Washington, D.C.
- U.S. Dept. of the Interior, Minerals Management Service (MMS). 2008. Collisions - Statistics and Summaries. May 5, 2009. <http://www.mms.gov/incidents/collisions.htm>.
- U.S. Dept. of the Interior, Minerals Management Service (MMS). 2009a. Renewable energy and alternate uses of existing facilities on the Outer Continental Shelf. U.S. Dept. of the Interior, Minerals Management Service. Washington, D.C.
- U.S. Dept. of the Interior, Minerals Management Service (MMS). 2009b. Guidelines for the Minerals Management Service Renewable Energy Framework. Washington, D.C.
- Ukiah Daily Journal Staff. 2008. Fishermen say feds stalling on wave energy concerns. Ukiah Daily Journal. July 22:Ukiah, CA. <http://nl.newsbank.com/nl-search/we/Archives>.
- United Kingdom Department of Business Enterprise and Regulatory Reform. 2009. Offshore Wind: Navigation. <http://www.berr.gov.uk/energy/sources/renewables/planning/offshore-wind/navigation/page18857.html>. June 4.
- University of Washington. 2009. Northwest National Marine Renewable Energy Center: About the Center. January 11, 2009. <http://depts.washington.edu/nmrec/about.html>.
- Vesseltracker.Com. 2009. May 5, 2009. <http://www.vesseltracker.com/app>.
- Washington Dept. of Ecology. 2008. Ecology challenges FERC for bypassing environmental reviews of energy projects. News Release. <http://www.ecy.wa.gov/news/2008news/2008-130.html>.

Weinstein, N. 2009. Wait is over for wave-energy facility to buoy up Reedsport. Daily Journal of Commerce. December 4:Portland, OR. <http://djcoregon.com/news/2009/12/04/wait-is-over-for-wave-energy-facility-to-buoy-up-reedsport/>.

Weiss, J., B. Boehlert and R. Unsworth. 2007. Assessing the costs and benefits of electricity generation using alternative energy Resources on the Outer Continental Shelf. U.S. Dept. of the Interior, Minerals Management Service. Herndon, VA.

Widman, M. 2007. Speeding up ocean energy permitting. Renewable Energy World.com. March 27, 2009. <http://www.renewableenergyworld.com/rea/news/article/2007/10/speeding-up-ocean-energy-permitting-50223>.

28. SUMMARY OF IMPACTS

Ocean energy devices include wave generators, tidal turbines, instream turbines (wave, tidal and current generators are referred to collectively as marine hydrokinetic devices), offshore wind, and ocean thermal energy conversion (OTEC) systems. The alternative energy technologies most likely to be used in the Northern Study Area are wave generation and offshore wind; similar impacts to the environment may occur due to installation and operation of these two technologies. The California Current System contains ample energy for power generation, however the coastal currents in the Northern Study Area are diffuse and variable, and lie too far offshore for energy generation to be considered in the near future. The waters of the Northern Study Area are too cold to make OTEC feasible.

The components of wave and offshore wind platforms are constructed on land and barged to the site in large pieces, then anchored to the sea floor. The offshore wind industry is moving further offshore into deeper water, making anchoring impractical; instead, the industry is engineering floating platforms that are ballasted in place, with one or more small anchors and cables reaching to the sea floor. Among the many designs of wave buoys currently under development, all are tethered to the sea floor by a cable and anchor system. Neither technology requires pile driving or other permanent installations into the sea floor. The use of tidal or instream turbines in the offshore areas is unlikely but could introduce additional threats in terms of blade strike and disturbance of the water column. With no permanent seafloor attachments such as piles, the deployment of offshore wind and hydrokinetic devices will cause short term disturbances including: sediment plumes and bottom impacts from anchor deployment; disturbance to organisms from increased vessel traffic; and oil and chemical spills from surface vessels, as well as spills of the limited volume of petroleum products contained in the gearboxes of the devices.

The structure and footprint of alternative energy installations will determine the potential impacts. The morphology of the continental shelf in the Northern Study Area ensures that the area targeted for alternative energy leasing will be in deep water, as compared to the Atlantic OCS ([see Chapter 2 Geology](#)). This depth will favor energy installations that include surface floats, such as wave energy farms, as well as large installations (like offshore wind platforms) that are ballasted rather than anchored. Each wave buoy attaches to a single anchor point; each offshore wind installation will require one to three small anchors and associated mooring lines. For either technology, the footprint of the bottom moorings will be small.

Marine organisms and the marine environment can be affected by wave generators and offshore wind turbines during construction, operation and decommissioning of these devices. During operation, wave devices will remove energy from the marine system that can lead to changes in water circulation and sediment transport, such that organisms may be unable to carry out their normal movements, feeding, and migrations activities. Other potential marine environmental impact-producing factors from wave and offshore wind generation include: (1) varying levels of noise from devices; (2) electromagnetic fields emitted from devices and electrical cables leading to shoreside grid connections; (3) leaching of deleterious chemicals into seawater from materials and coatings on devices, anchors, and mooring cables, as well as petroleum products used for lubrication and transformer cooling; (4) sediment scour around the base of anchors; (5) surface

platforms in place of open space; (6) surface and subsurface structures and mooring cables; (7) disturbance of habitats along the cable route, particularly as cables cross the intertidal; and (8) damage to sensitive habitats, particularly if equipment is ripped from moorings during heavy storms and washed ashore. Impacts during decommissioning are similar to those occurring during construction.

29. SUMMARY OF DATA GAPS

This chapter summarizes the data gaps for each oceanographic discipline covered in the report, including both resources and impacts, which are identified separately within each discipline where sufficient detail warrants. For more detail, refer to the “Summary and Data Gaps” section of each chapter.

29.1 PHYSICAL OCEANOGRAPHY

For both wind energy and wave energy, future information needs will be geared toward answering the following questions: What is the energy potential? How can the energy potential be realized? What are the environmental effects of the reduction of energy in the ocean by energy-capturing devices?

29.1.1 Resource Data Gaps

One advantage wind power research has over wave power research is that there are already offshore wind parks established in Europe. Some of the European offshore wind parks have been in place long enough to illuminate possible effects of offshore wind energy capture that were previously unknown. The coastal wind environment off Europe is fairly similar to that of the northwest coast of the United States. Like the northwest coast of the United States, the coast of Europe is at midlatitudes, west-facing, and on the eastern boundary of a large ocean.

Although wind parks have been established in Europe for some time now, there does not appear to be very much data on the oceanographic effects of offshore wind energy removal by wind parks. However, research has been performed on the effects of wind energy removal and wind-turbine-induced turbulence in regard to wind park efficiency and energy production. From the results of these studies the effects on the ocean can be inferred, but they are not specific. Specific studies will need to be performed to explain the effects of wind energy removal on upwelling. For this to be done, the effects on the mechanics of upwelling may need to be addressed: How might surface divergence, wind stress curl, and Ekman transport be affected? Other questions that should be answered are: How might decreased wind speed and increased turbulence in the wake of turbines affect ocean surface mixing? How might ocean atmosphere fluxes be affected? How much of the sea surface behind wind turbines might be affected?

Further data on the longshore and cross-shore variability of the winds (in magnitude and direction) would be useful in maximizing offshore wind park efficiency. Significant differences in the winds recorded at buoys along the coast indicate variations in the wind environment. The sparsely placed buoys collecting meteorological data along the coast are not able to completely resolve all nuances in the wind environment. Increasing the density of buoys would improve forecast ability and provide more continuous data.

More directional wave energy spectrum data and analyses are needed to maximize energy capture efficiency. Most research on directional wave spectrum analysis has been geared toward beach erosion and sediment transport. Little research has been done on directional wave energy spectra, even though many CDIP buoys have been collecting data along the West Coast for over

10 years. The data are there. It would not be difficult to perform a directional wave energy spectral analysis.

Before either wind parks or WEC energy extraction devices are deployed, there first needs to be an extended period of wind and wave data collection to accurately characterize the conditions. For wind data this will entail deployment of surface meteorological buoys. Enough buoys will have to be deployed to capture the spatial variation of the wind environment. Such data can then be used to inform the deployment of wind parks.

Similarly, extensive wave data need to be obtained prior to the deployment of any WEC devices. In this case a combination of CDIP-type buoys and arrays of HF radar is recommended to capture the spatial variability of the local wave regimes. Multi-year data sets should be collected and analyzed before any permits for either wind parks or WEC devices are issued. All the measurements should continue with the deployment of energy-extracting devices, and an independent panel of scientists should be engaged to verify the effects, both positive and negative, of the energy extraction efforts.

29.1.2 Impact Data Gaps

The lack of information on sediment transport and its relation to varying wave environments makes it difficult to assess the impacts of seasonal and longer-term changes in the wave environment. In addition, the impacts of reducing wave energy in the nearshore zone due to absorption of energy by WEC devices are difficult to assess.

More data are needed on the effects of WEC parks on the shoreline even if the expected impacts are believed to be small. At this time there are no large-scale WEC parks in existence, so actual data is not available. Beach morphology and sediment transport along the northwest coast are an area that is sparsely studied. Monitoring for changes will need to be performed on specific regions directly inshore of proposed WEC parks. For each proposed site, data will be needed on how decreases in wave height affect the incident angle of breaking waves as well as the distance from shore at which waves break, and how such decreases affect offshore sand bars, sediment transport, nearshore currents, wave runup, and estuary mouth morphology. Implementation of wave models will also be useful. Although there have been studies on how waves are diffracted by objects that block them, no studies have investigated how diffracted wave energy will be affected by partially blocked waves. Wave models could determine the extent of the “wave shadow” and how diffracted waves will eventually constructively interfere with each other.

In areas where wind and wave power extraction devices are currently in place, data on environmental changes associated with the devices is critical. Observational programs are needed to distinguish between environmental changes caused by the devices and naturally occurring environmental shifts in the physical environment (e.g. wind and waves). Environmental alterations are potentially different for a single device than they are for an array of devices (e.g. scour vs. group scour). This type of information will help to frame potential impacts for planned device placements within the U.S. OCS.

29.2 GEOLOGICAL OCEANOGRAPHY

29.2.1 Resource Data Gaps

Data gaps for the Northern Study Area are: (a) the fate and transport of chemical constituents across the continental shelf; (b) the impacts of erosive processes on the shelf; (c) the degree to which tectonic activity may affect offshore wind and wave installations in the Northern Study Area; and (d) the sedimentation patterns that may be disrupted by the presence of platforms, cables, and anchors.

29.2.2 Impact Data Gaps

Additional data are needed to determine the degree to which tectonic activity may affect offshore wind and wave installations in the Northern Study Area. Estimates of potential secondary biological injury could be made from other infrastructure examples. In addition, data are needed to support a better understanding of the sedimentation patterns that may be disrupted by the presence of platforms, cables, and anchors.

29.3 CHEMICAL OCEANOGRAPHY

29.3.1 Resource Data Gaps

Data and analyses are needed on the relationship between changes in atmospheric chemistry, oceanic pH levels, coastal upwelling, and biogeochemical processes within the Northern Study Area.

The relationship between coastal organic matter cycles, development of hypoxia, and large-scale climate drivers (e.g. Pacific Decadal Oscillation (PDO) and El Niño Southern Oscillation (ENSO)) continues to be an area of evolving research within the Northern Study Area. Also needed are studies to determine the response of marine micro-organisms to the riverine nutrient and carbon supplies on a broader timescale to determine the influence that ENSO/La Niña cycles and other atmospheric fluctuations might have on winter precipitation, productivity, and ultimately, the riverine inputs and ecosystem response.

29.3.2 Impact Data Gaps

The relationship between ocean climate change, upwelling-driven hypoxia, and ecological perturbations is critical. In addition, information is needed on the role that iron sources from shelf sediment have on fueling primary productivity, which further perturbs existing low-dissolved-oxygen conditions off the coast. The impacts from alterations in sedimentary transport from the shelf into the estuary resulting from energy consumption from the system, stratification and dissolved oxygen distributions, and sources/sinks of micronutrients such as iron (from alternative energy structures) are critical knowledge gaps for the Northern Study Area.

Additional information is needed to better understand the correlation between energy removal from the system and changes in dissolved oxygen and other water quality parameters. Changing patterns of sediment transport also require further elucidation to determine whether the redistribution of sediment types has an effect on other parameters, including those affecting

marine organisms. In addition, the removal of energy from the system may increase water column stratification by slowing mixing processes and altering the ventilation of deepwater or the replenishment of dissolved oxygen, which would adversely impact marine life and fisheries. On the continental shelf, the subtle vertical mixing near the bottom leads to usually high productivity of the more northern waters of the Northern Study Area by supplying more iron nitrate could be monitored for changes. Monitoring for alterations in nutrient supply and productivity changes is important, and areas of the Northern Study Area have unusually high productivity.

Water column measurements are needed to understand the effects and distribution of antifouling paints and coatings from alternative energy installations, and to examine the potential for deploying new paints and coatings that are effective against fouling organisms and harsh ocean conditions, while being less toxic to organisms.

29.4 PHYTOPLANKTON, ZOOPLANKTON, PELAGIC INVERTEBRATES

29.4.1 Resource Data Gaps

There are few oceanographic investigations of phytoplankton and zooplankton species in the Northern Study Area. In order to determine whether there are species shifts and changes in productivity in the future, it is necessary to establish a comprehensive baseline of phytoplankton and zooplankton productivity such as those established off Vancouver Island, British Columbia and Newport, Oregon. Monitoring plankton species would require a multi-year extensive program. Surrogate measures such as remote sensing of chlorophyll from satellites (SeaWiFS primarily) and adequate collection of samples for groundtruthing may be the most effective and efficient way to establish a baseline for the phytoplankton. Coupled with a small number of focused studies to determine whether zooplankton are following similar patterns in time and space would be helpful.

Similarly, little is known about pelagic invertebrates in the study area. It would be helpful to establish a baseline of population, habitat use, and productivity of the major invertebrate groups. Fisheries surveys routinely gather population data for commercially important organisms; adding other pelagic invertebrates to that list would allow for a cost effective snapshot of the status of the pelagic invertebrates.

29.4.2 Impact Data Gaps

Studies that target the effects of climate change on pelagic primary and secondary producers are needed to establish a current baseline of productivity and community composition against which to compare future measurements. Through the use of measurements of sea surface temperature and pH, exposure curves could be constructed to assess the impacts that future changes will have on the base of the food chain.

Additional research is needed to determine whether changes in energy within the system caused by energy extraction will affect plankton populations and productivity.

29.5 MACROPHYTES

Better aerial maps of the presence of macrophytes in the Northern Study Area would allow a better assessment of areas at risk from human disturbance. A better understanding of the role of invasive algae, seagrasses, and marsh grasses is needed as climate change continues to put additional pressure on macrophyte communities and the habitats they create.

29.6 BENTHOS

29.6.1 Resource Data Gaps

Baseline monitoring of benthic communities is needed to document their present condition; however, studies of species diversity and abundance are necessary throughout the life of any offshore project.

29.6.2 Impact Data Gaps

Data from monitoring is also needed to determine the degree to which changes in sedimentation patterns caused by alternative energy facilities will affect deep- and shallow-water benthic habitats. Investigations are needed to determine the toxicity of particular chemical coatings and paints to benthic organisms. Development of less toxic alternative coatings and paints is also needed.

The effects of noise, particularly on large invertebrates, has not been well studied and should be a focus of future research.

As more is learned about biophysical coupling on the Northern Study Area continental shelf (Hickey and Banas 2008), observations of upwelling, vertical mixing, nutrient fluxes and benthic assemblages could be used to determine alterations in the ecosystem. As affected state, regional, and local agencies create adaptation strategies to climate change, additional information on habitat migration and migration corridors could be useful in planning for the lifetime of an installation.

29.7 FISH

29.7.1 Resource Data Gaps

State and Federal fisheries management agencies carry out annual stock assessments of some species to aid in setting future harvest allocations, or to monitor population levels in response to legally mandated needs to protect declining resources. However, populations of the vast majority of fish in the Northern Study Area are never assessed. In order to determine baselines of fish populations against which to measure future changes, additional broad and frequent monitoring for fish abundance of all species in all habitats throughout the area is needed, particularly those species which are not exploited for commercial or recreational purposes. Based on the diversity of stocks and species, monitoring information is needed at a localized level to answer specific questions that will arise when siting infrastructure in the Northern Study Area. Additionally, research that delineates life history, including the seasonal location of larvae and juveniles, is needed for most marine and anadromous species in the region.

A thorough understanding of the prey available to fish populations in the Northern Study Area is needed to determine the stressors that may affect fish populations. Monitoring of prey populations, particularly zooplankton and ichthyoplankton, will help determine what resources higher trophic levels can draw upon.

As fisheries management shifts to an ecosystem-based approach, more research will be needed on the interactions between fish species, predators, prey, climate trends, ocean conditions, and human use impacts. More research is needed to refine management approaches to adapt to and mitigate ocean acidification effects and maintain resilience in marine systems and fish populations.

29.7.2 Impact Data Gaps

As climate change effects become more prominent in the coastal and open ocean in coming decades, it will become more difficult to sort impacts on fish stocks from new activities (such as alternative energy development) from those occurring due to climate change. As a specific example, ocean acidification is an emerging issue related to climate change that may have wide-ranging ecosystem effects and may lead to further shifts in climatic regimes, yet we understand little about the impact that lower pH levels will have on fish, their prey, or their habitats.

Additional research is needed to understand the behavior of fish around surface floats to determine whether the aggregation that these structures encourage may have an impact on populations, particularly those that are threatened or endangered. An improved understanding of the impact of noise and EMF on fish is needed, as is understanding of the specific impacts of chemical coatings and antifouling paints.

Sensitivity of embryonic and larval fish to toxic chemicals is an emerging issue. Leaching of chemical coatings and paints, as well as spills of petroleum products, may cause acute or chronic toxicity to fish, particularly sensitive early life stages including embryos and larvae. Data on chronic and short term (e.g. spill scenario) exposures is needed in order to assess risk in combination with location and timing data.

29.8 SEA TURTLES

29.8.1 Resource Data Gaps

While much more information about these long-lived species is becoming available with the advancement of satellite-telemetry technology, little remains known about their post-hatchling stages. Additionally, comprehensive population estimates are hard to compile because of the solitary nature and wide distribution of individuals.

29.8.2 Impact Data Gaps

While the effects of noise have been studied, more complete information is needed to fully understand the risk of chronic sound and response behaviors. The effects of electromagnetic fields are also not well understood. Sea turtles navigate using electromagnetic cues from the

Earth, and disruption or masking of that signal could have pronounced effects on migration and the ability to locate foraging or nesting grounds.

29.9 BIRDS

29.9.1 Resource Data Gaps

Although links have been made between seabird distribution, abundance, and forage availability, information on the distribution and abundance of seabirds over all seasons along the Pacific Coast of the United States is sparse or does not exist at the scale needed to assess adequately the potential impact of alternative energy development on birds. Seabird densities should be mapped to define important feeding areas, migration routes need to be defined, flight pathways of large breeding colonies should be established in three dimensions.

Accurate rates of consumption of marine organisms need to be established to determine the energetic consequences of avoiding foraging areas because of offshore structures. Similarly, it is important to model the energetic needs of birds in the Northern Study Area to understand their reproductive fitness and the stress that new offshore development may cause. Offshore seabird distribution has been related to forage abundance, yet there is little information to identify the forage utilized by Pacific seabird species or the distribution and abundance of forage, as related to the Northern Study Area.

29.9.2 Impact Data Gaps

Future research must evaluate and quantify the effects of noise and EMF on a variety of seabirds, shorebirds, and marshbirds. Applied research is needed to develop surface structures and lighting regimes that minimize migratory bird interactions and that do not threaten migration pathways. Further work should be done to develop collision risk models that accurately predict the probability of avian mortality from collision with wind turbines. Additionally, avoidance behavior of key species should be evaluated.

29.10 MARINE MAMMALS

29.10.1 Resource Data Gaps

While overall data on abundance and distribution of marine mammals are available, these are often not on fine spatial scales potentially relevant to assessing impact of specific energy development projects. This would include baseline data on marine mammal species occurrence, distribution, and behavior. In particular, data gaps are most critical for species with sensitivity to low-frequency sounds, including harbor seals, baleen whales, and possibly harbor porpoises.

Data gaps are especially relevant for gray whales because this coastal species is likely to come into frequent contact with alternative energy development. Since this species occurs only in the North Pacific, it has not been included in studies in the North Atlantic or other waters off Europe where most research has been done. The Northern Study Area is not only a migration route for the entire eastern gray whale population, but also the feeding area for a small but regular

component of this population. The seasonally resident members of the population would face cumulative effects of exposure to alternative energy sites.

29.10.2 Impact Data Gaps

Several important data gaps related to acoustics and marine mammals still exist including: (1) identifying what ambient sounds occur at the site of a potential wave energy facility; and (2) determining the hearing sensitivity of cetaceans and pinnipeds and how they respond to noise at frequencies generated by a wave energy buoy or buoy array.

29.11 ECOSYSTEM RELATIONSHIPS

A thorough baseline assessment of the pelagic and benthic community structure of the Northern Study Area is needed to establish a benchmark against which future changes due to natural causes human activities can be measured. Periodic monitoring of the degree of human invasion of pelagic and coastal populations is also needed to determine how biogeographic forces and human activities are changing the assemblages.

29.12 AREAS OF SPECIAL CONCERN

Future research needs should focus on inventorying resources of the Special Areas and understanding the ecological processes taking place in those areas, so that future impacts can be measured and restoration activities planned.

29.13 SOCIOECONOMICS

The significance of space-use conflicts can be assessed, in the case of commercial fisheries, by examining the spatial and temporal nature of fishing activities. Databases maintained by the Pacific States Marine Fish Commission (PSMFC) are useful in this respect. The Pacific Fisheries Information Network (PacFIN) provides timely and accurate data essential for effective fisheries management.

The West Coast Groundfish Observer Program, operated by the National Marine Fisheries Service's Northwest Fisheries Science Center, places observers on commercial fishing vessels to monitor and record catch data, including species composition of retained and discarded catch. The objective of this program is the provision of accurate accounts of total catch, bycatch, and discards associated with different fisheries.

Taken together, the above data sources facilitate evaluation of the potential impacts of offshore alternative energy development on commercial fisheries. While these data sets contain extensive information on catch, there are limited data on fishing effort, catch per unit of effort, and harvesting costs, both spatial and temporal. Research to address these data deficiencies would improve the ability to evaluate the impacts of alternative energy activities.

With respect to recreational fisheries, spatial conflicts can be assessed using the Pacific Recreational Fisheries Information Network (RecFIN) database. California, Oregon, Washington, and NMFS contribute to the database maintained by the PSMFC.

The Marine Recreational Fisheries Statistics Survey (MRFSS) generates independent estimates of effort and catch through two separate survey components: a bimonthly household telephone survey, and a continuous onsite, access-point-intercept survey of angler fishing trips. RecFIN expands on this coastwide overview of marine recreational catch and effort to incorporate all State and Federal sampling programs into an integrated system.

Input-output models, such as IMPLAN, an economic input-output software package and data set developed by MIG, Inc., can be used to estimate total job creation including multiplier impacts of a proposed project at different scales. The IMPLAN input-output model also provides other measures of economic activity, such as output (dollars' worth of production) and regional income (the sum of worker wages and salaries plus business income and profits).

Also useful may be the Jobs and Economic Development Impacts (JEDI) Wind model, an input-output model developed for the National Renewable Energy Laboratory specifically to estimate the economic benefits from a new wind energy facility. Like IMPLAN, the JEDI Wind model calculates direct, indirect, and induced economic impacts in terms of jobs, wage and salary income, and output both during the construction period and during the operating years. Further development and refinement of input-output models that address specific cost profiles for offshore alternative energy development would be helpful in projecting economic impacts.

VOLUME II—SOUTHERN STUDY AREA

PART I—SOUTHERN STUDY AREA: RESOURCES

1. PHYSICAL OCEANOGRAPHY

The Southern Study Area contains both the southern end of the large West Coast upwelling region that ends at Point Conception, and the relatively sheltered Southern California Bight (SCB). The geometry of the coastline and topography create a definitive break between the circulation inshore of a line running approximately between Point Conception and Ensenada, Mexico. Inside this line winds are weak, while offshore of this line the wind speeds are comparable in magnitude to those found over the continental shelf north of Point Conception. Winds and currents have a distinct seasonal cycle, with both shorter term variations such as short term coastally trapped wind reversals, and longer term cycles that are influenced by the larger Pacific Ocean setting. Winds generate waves within the Southern Study Area, both locally and from powerful storms located in distant regions of the Pacific. The deep basins of the SCB generally renew water during seasonal flushing that moves from the offshore basins to the more inshore ones. Long-term oxygen concentration and mixing trends in some deep basins indicate periods of water stagnation punctuated by periods of water renewal.

This chapter discusses important data sources ([section 1.1](#)), the different temporal variations in winds, currents and water properties ([sections 1.2 to 1.5](#)), deep basin water renewal ([section 1.6](#)), the wave climate ([section 1.7](#)), and, finally, provide a summary and research needs discussion ([section 1.8](#)). The temporal scales discussed are seasonal ([section 1.2](#)), subtidal ([section 1.3](#)), tidal and supratidal ([1.4](#)), and interannual ([section 1.5](#)).

1.1 DATA SOURCES AND ANALYSIS

No single data set has influenced our understanding of the ocean along the Southern California coast as much as the California Cooperative Oceanic Fisheries Investigations (CalCOFI, <http://www.calcofi.org/>). CalCOFI is a partnership between the California Department of Fish and Game, the NOAA National Marine Fisheries Service and the Scripps Institution of Oceanography. Both the CalCOFI reports, and research work from other scientists using the accumulated data are too numerous to list here. The cruises began in 1937 off Southern California, and have varied temporally and in spatial coverage, but provide the best long-term sampling of an oceanographic region in the United States. For a full station map through time, please see http://www.calcofi.org/newhome/data/station_occupation.html.

The NOAA National Data Buoy Center (NDBC, <http://www.ndbc.noaa.gov>) has over 30 buoys deployed off the coast of the Southern Study Area ([Figure 1.1](#)). Archived and current oceanographic and meteorological data collected from the buoys are available on the NDBC website. These data include: Wind Direction (WDIR), Wind Speed (WSPD), Wind Gust (GST), Wave Height (WVHT), Dominant Wave Period (DPD), Atmospheric Pressure (PRES), Pressure Tendency (PTDY), Air Temperature (ATMP), Water Temperature (WTMP), Wind Chill (CHILL), Significant Wave Height (WVHT), Swell Height (SwH), Swell Period (SwP), Wind Wave Height (WWH), Wind Wave Period (WWP), Wave Steepness (STEEPNESS), Average Wave Period (APD), and Swell Direction (SwD).



Figure 1.1. Offshore buoys locations found in the Southern Study Area.

Source: <http://www.ndbc.noaa.gov>

One DART (Deep-ocean Assessment and Reporting of Tsunamis) real-time buoy is located off Southern California ([Figure 1.2](#)). The full array of 39 stations for early detection of tsunamis was completed in March 2008. These new two-way communication buoys are critical for research and forecasting of tsunami events. When operating in standard mode, these buoys collect bottom pressure and temperature every 15 seconds. When an event is detected by the buoy or anticipated, the buoy operating mode is changed to collect data more frequently.

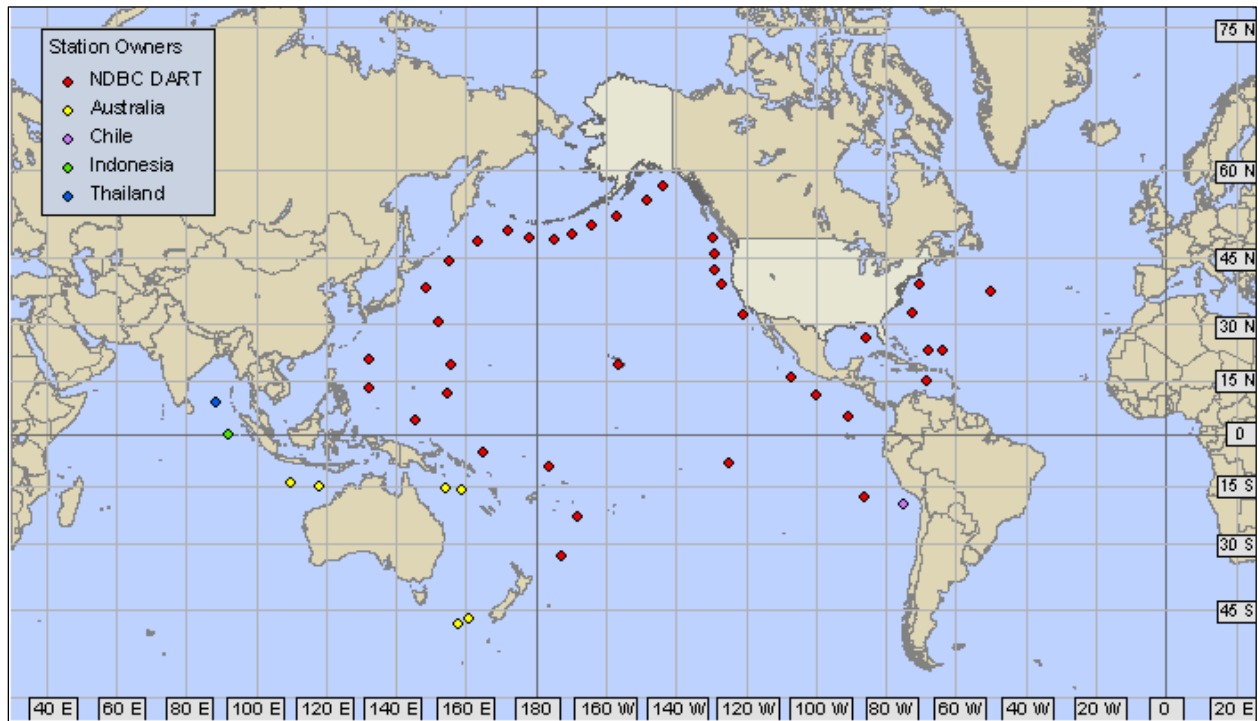

Figure 1.2. DART buoys locations around the world.

Source: NOAA's National Buoy Data Center.

The Coastal Data Information Program (CDIP, <http://cdip.ucsd.edu>), Integrative Oceanography Division, operated by the Scripps Institution of Oceanography, under the sponsorship of the U.S. Army Corps of Engineers and the California Department of Boating and Waterways., measures, analyzes, archives, and disseminates coastal environment data. CDIP operates and maintains about 80 buoys off the West Coast. There are two types of CDIP buoys that record wave data (directional wave data and nondirectional wave data) and one type of buoy that records meteorological and oceanographic data. CDIP provides coastal wave model outputs as well as wave energy spectral plots. The locations of CDIP buoys in the Southern Study Area are included in [Figure 1.3](#). More information on waves in the Southern Study Area is available in [section 1.7 Wave Climate](#).

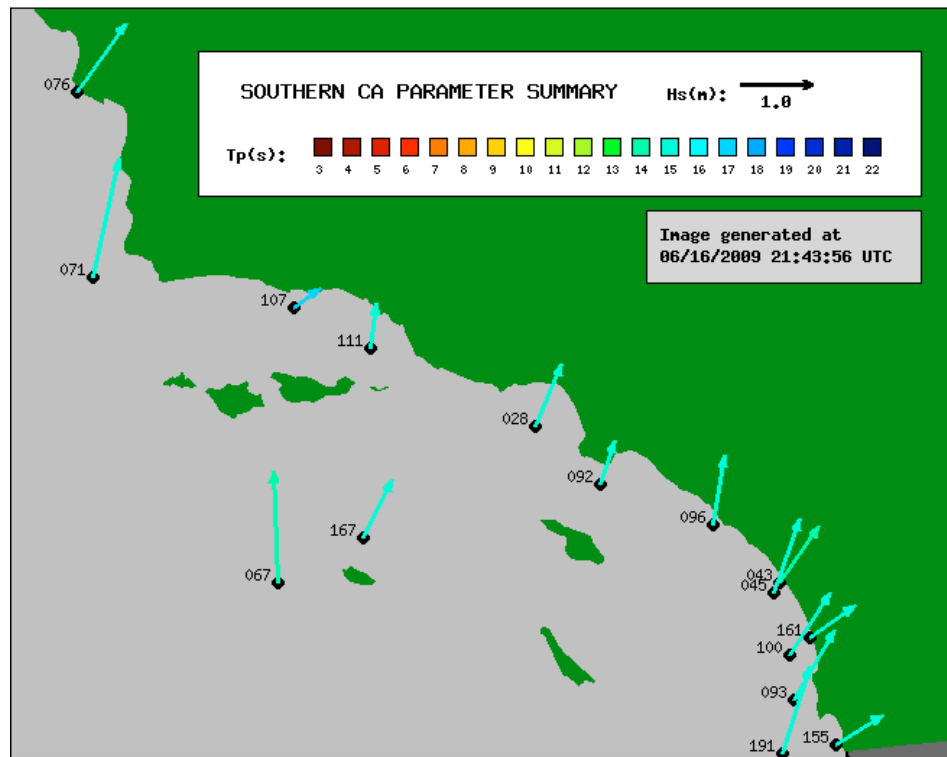

Figure 1.3. CDIP buoys locations in the Southern Study Area. Buoy numbers are the CDIP buoy numbers, though all buoys also have a NOAA/NDBC designation.

Green/gray in lower left corner is the United States / Mexico border.

Source: CDIP, Scripps Institution of Oceanography.

The NOAA National Weather Service (NWS) provides up to date, as well as archived, meteorological information, data and reports. There are numerous stations all along the coast. The NOAA National Climatic Data Center (NCDC, <http://www.ncdc.noaa.gov/oa/ncdc.html>) provides recent and archived climatic data as well as background information and up-to-date reports on the state of the climate for all regions of the world. This includes the current state of climatic oscillations such as the El Niño Southern Oscillation (ENSO), Pacific Decadal Oscillation (PDO), and Madden Julian Oscillation (MJO) and climatic indices such as the Multivariate ENSO Index (MEI), Southern Oscillation Index (SOI), and North Pacific Index (NPI).

The Southern California Coastal Ocean Observing System (SCOOS, <http://www.scoos.org>) provides a variety of data products for the Southern California Bight. The available products include automated shore stations, bathymetry, chlorophyll and Harmful Algal Booms (HABS), shore stations, meteorological observations, moorings, plume tracking, Ports and Harbors, Regional Ocean Modeling System (ROMS) model output, satellite imagery, ship tracking, ships and gliders, shoreline water quality, surface current mapping, wave conditions and wind and rainfall forecasts. A summary map of all the SCOOS observational systems is provided in [Figure 1.4](#).

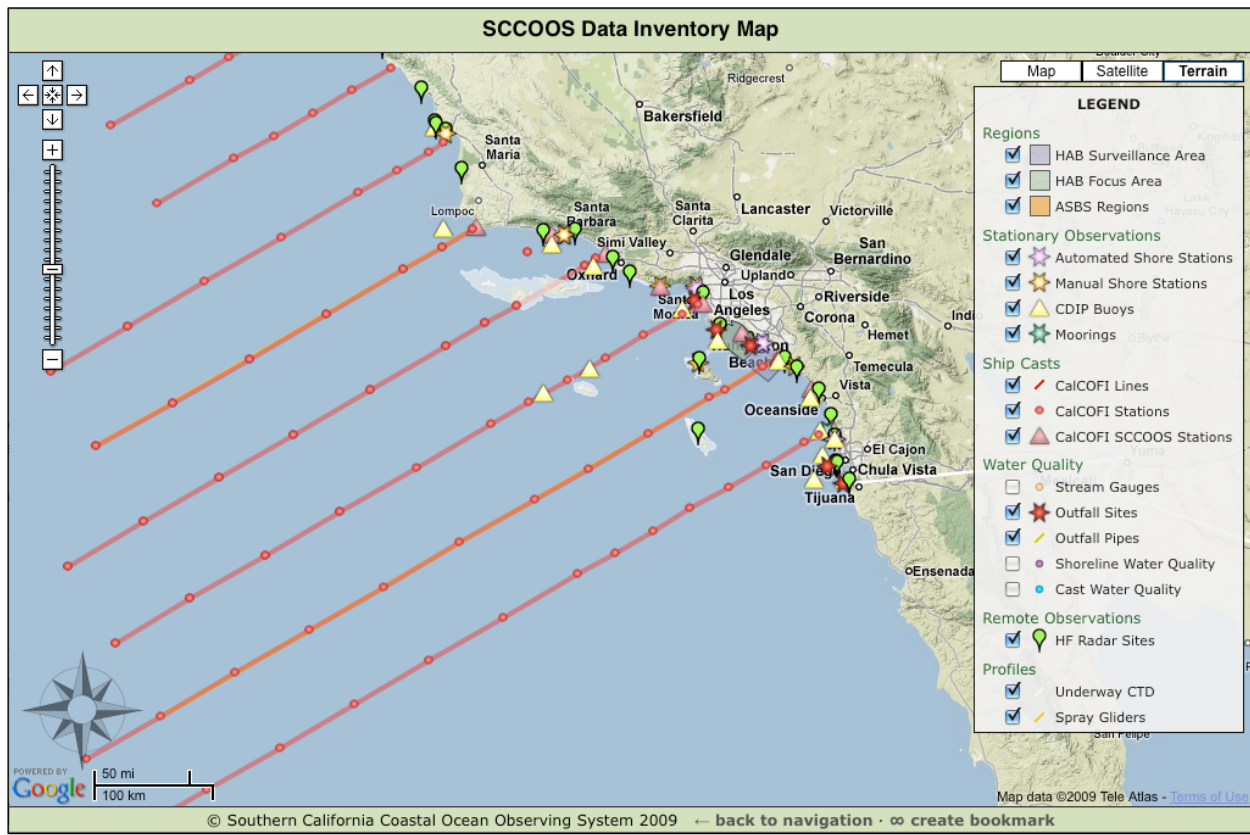

Figure 1.4. Full Southern California Coastal Ocean Observing System (SCOOS) observational data inventory.

Source: Southern California Coastal Ocean Observing System, www.scoos.org.

There are a number of satellite imagery resources available. Lists of resources are provided by NOAA National Climatic Data Center (NCDC) are available at <http://www.ncdc.noaa.gov/oa/climate/climateresourcesother.html#sat>, the Space Science and Engineering Center (SSEC) at <http://www.ssec.wisc.edu/data/index.html> and the Navy at http://www.nrlmry.navy.mil/sat_products.html. The following satellite imagery is available: visible, infrared, sea surface temperature, water vapor, scatterometer winds, AVHRR sea surface temperature, SeaWiFS and MODIS chlorophyll concentration, and sea surface level.

The two most widely used numerical weather forecasting models in the United States are the NAM (North American Mesoscale) and GFS (Global Forecast System). These three-dimensional models assimilate atmospheric data to generate surface and upper-atmospheric weather forecast maps of parameters such as pressure, wind, temperature, humidity, precipitation, vorticity and divergence. Outputs of current and archived model runs are available from the NOAA National Center for Environmental Protection (NCEP, <http://www.nco.ncep.noaa.gov/pmb/nwprod/analysis>). Another popular mesoscale atmospheric model is the Pennsylvania State University/ National Center for Atmospheric Research mesoscale model known as MM5 (<http://www.mmm.ucar.edu/mm5/>). The U.S. Navy produces two products, the low-resolution global wind product NOGAPS (Navy Operational Global

Atmospheric Prediction System) or WXMAP (Global & Regional Weather Prediction Charts) and the regional high resolution model COAMPS (Couple Ocean / Atmosphere Mesoscale Prediction System). These wind products are available at the Fleet Numerical website <http://www.nrlmry.navy.mil>.

Wave Watch III (WW III) wave model outputs are available to the public through the U.S. Navy (<https://www.fnmoc.navy.mil/public>) and NOAA (<http://polar.ncep.noaa.gov>). These model outputs provide information on significant wave height, swell wave height, wind wave height, peak wave period, secondary wave period, swell wave period, wind wave period, and whitecap probability. LOLA is a coastal wave model available through the popular surfing website www.surflines.com. Two wave models that are used by the scientific community are the Simulating Waves Near-shore (SWAN) model and the Delft3D-WAVE model.

1.2 SEASONAL PATTERNS

1.2.1 Winds

The surface atmospheric pressure field drives surface winds. Along the West Coast of the U.S. large-scale wind patterns are primarily driven by three persistent large-scale features in the surface pressure field: the North Pacific High, the Aleutian Low, and the Thermal Low. The North Pacific High is a climatological mean surface high pressure pattern that is typically situated over the eastern North Pacific and drives the winds southward along the Southern Study Area. The Aleutian Low is a mean surface low pressure pattern that is typically situated over the Gulf of Alaska and drives the winds northward along the northern regions of the Southern Study Area. The Thermal Low is a mean surface low pressure pattern caused by local surface heating in the southwest United States and assists the North Pacific High in driving winds southward along the coast. An example of these three pressure systems and surface wind stress during the Spring/Summer can be seen in [Figure 1.5](#). Note that these are “mean” pressure fields and do not necessarily represent the atmosphere at any point in time, as the atmosphere is very dynamic and constantly changing. The calculated mean Aleutian Low pressure field is largely influenced by repeated low pressure cyclonic systems propagating across the Bering Sea and Gulf of Alaska. There is significant annual (or decadal) variability with the strength and position of these pressure fields. Climatic oscillations such as the Pacific Decadal Oscillation (PDO) and El Niño Southern Oscillation (ENSO) can significantly alter the mean pressure and wind fields.

Dry summers and mild winters characterize Southern California, with precipitation from passing storm systems. Summers in the northern portion of the SCB, in the vicinity of the Santa Barbara Channel, are generally cloudy and cool, while further south in the SCB the summers are very hot and dry. Topography along the mainland coast of the Santa Barbara Channel (Dorman and Winant 1995) blocks the upwelling favorable north winds, leading to strong wind stress curl in the vicinity of Point Conception.

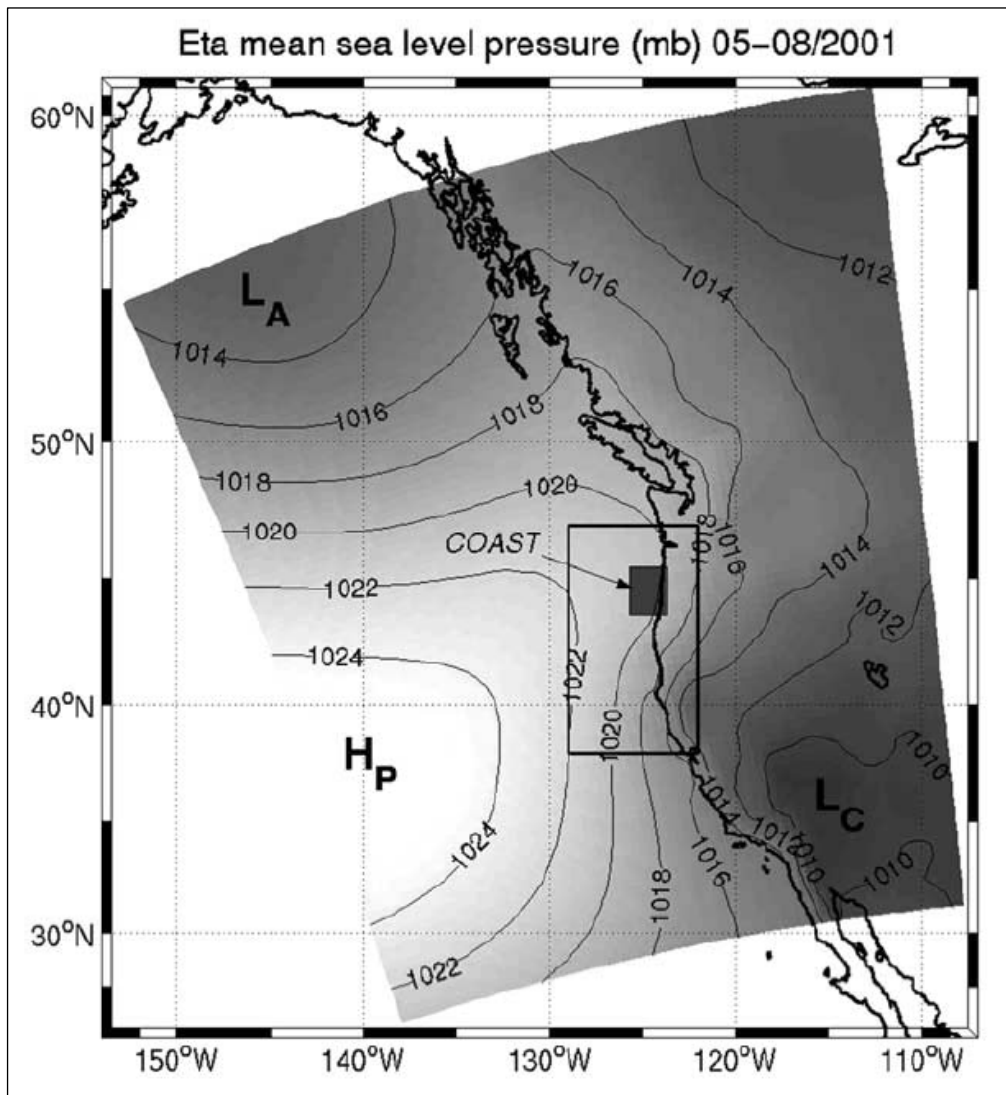

Figure 1.5. Mean sea level pressure (mb) over the northeast Pacific during May through August 2001, from the NCEP Eta model.

The North Pacific High = H_p , the Thermal Low = L_c , and the Aleutian Low = L_A .

From Bane et al. (2005).

Dorman and Winant (1995) discuss the annual winds along the entire West Coast ([Figure 1.6](#)). Winant and Dorman (1997) discuss the annual cycle in wind stress and heat flux in detail. The oceanographic response to the winds varies with the wind stress, which varies as a function of the square of the wind speed. During summer, large surface gradients establish and are stable.

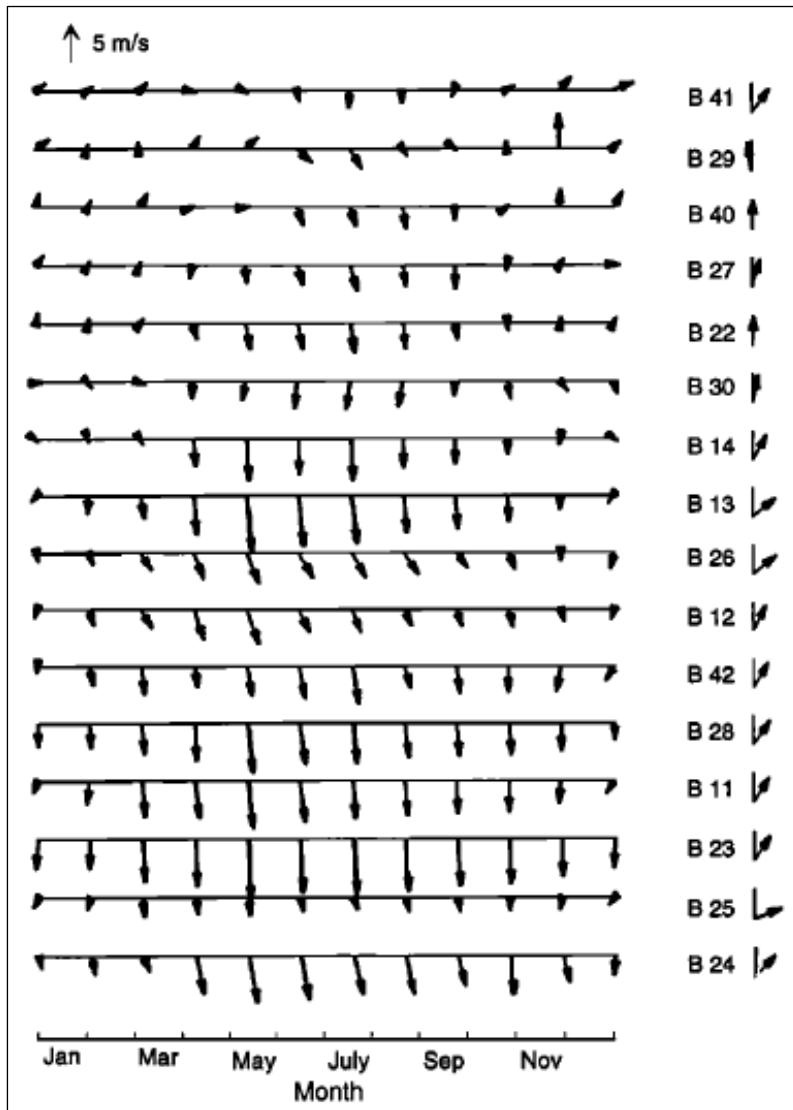

Figure 1.6. Annual cycle of the wind.

For each location the vertical direction corresponds to the principal axes. The relative orientation of that direction from north is shown at the right with the vectors pointing due north. The last two digits of the NDBC buoys along the coast are number on the right such that B 42 refers to NDBC buoy 46042.

From Dorman and Winant (1995).

The geometry of the coastline and topography create a definitive break between the circulation inshore of a line running approximately between Point Conception and Ensenada, Mexico. Inside this line, winds are weak, while offshore of this line the wind speeds are comparable in magnitude to those found over the continental shelf north of Point Conception. This imaginary line marks the location of maximum wind stress curl. At the spatial resolution afforded by the CalCOFI, the maximum wind stress is approximately three times larger than previously proposed

values. Net heat flux estimates derived from the CalCOFI measurements are only somewhat larger. In winter, the surface atmosphere is more homogeneous, though temporally variant as low pressure systems move through the area.

Schwing and Mendelsohn (Schwing and Mendelsohn 1997a; 1997b) used statistical methods to find long-term trends in the seasonal cycle. Using the Comprehensive Ocean-Atmosphere Data Set (COADS), they note that coastal alongshore winds have systematically increased during the early portions of the warm season (April – July), increasing upwelling forcing. This trend is also seen in NOAA National Centers for Environmental Prediction (NCEP) monthly averaged winds (Kalnay et al. 1996). Please see [section 1.5 for](#) further discussion on longer term trends.

1.2.1.1 Santa Barbara Channel

The Santa Barbara Channel remains sheltered from strong winds throughout the year. There are two seasons: a warm season (April through September) and a cool season (October through March), with the strongest winds occurring in summer (Dorman and Winant 1995; Dorman and Winant 2000). The monthly annual cycle of winds is shown below in [Figure 1.7](#). Point Conception represents the maximum in wind speed along the California coast: in the summer, Point Conception and the area between Point Reyes and Point Arenas in Northern California are the maximums, while in winter Point Conception is the single maximum.

As the warm season begins and peaks in summer, winds are increasingly steady with stronger southeastward winds favorable to upwelling. Topography along the northern part of the channel steers these persistent southeastward winds (Dorman and Winant 2000), causing Point Conception to have the maximum winds, as the air is forced to move around the mountains ([see Figure 1.8](#)). Point Conception becomes the maximum of the generally positive wind stress curl in the Bight, with negative wind stress curl offshore (Winant and Dorman 1997). Winds become more eastward inside the channel because of this steering. Along the northern coast of the Santa Barbara Channel these eastward winds sometimes reverse to westward at night. The winds in the eastern boundary of the channel (offshore if the Oxnard plain) are generally weak.

Within the Santa Barbara Channel, Sea Level Pressure gradients are also largest in the peak warm season (summer), with a distinct Marine Atmospheric Boundary Layer (MABL) that reaches a maximum of 300-350 m thick during the night. This MABL is distinct from the free atmosphere. The ocean surface interacts with the MABL, causing strong winds parallel to the coast, which leads to upwelling and lower Sea Surface Temperatures (SST) near the coast.

The cool season winds are variable due to low pressure systems moving through the area. As these low pressure systems pass by, strong southeasterly winds precede the low, followed then by northwesterly winds. During the warm season (April-September) coastally trapped wind reversals occur from Point Conception northward to Washington State (Mass and Bond 1996). Generally these reversal events evidence sustained southward winds for a few days, then shift to northward winds for about one day. Near Point Conception, there are an average of 2 reversals each month, with an average of 0.5 strong reversals per month, where strong is defined as the reversal (northward) wind reaching at least 5 m/s. Statistics vary greatly from year to year, with

some years showing no reversals. These reversals are important, as they show the potential for a spill to move consistently in one direction, then suddenly shift to moving the opposite direction.

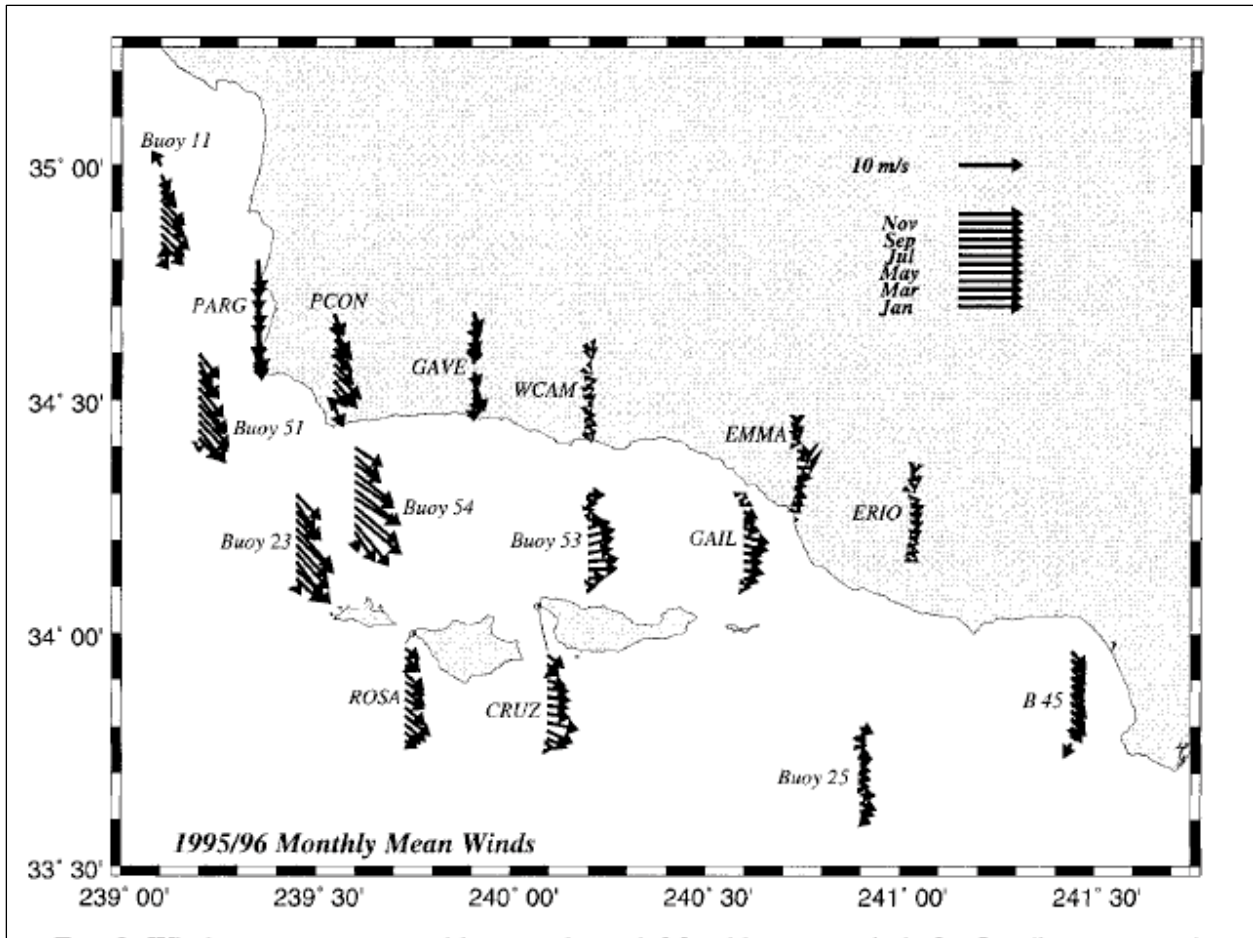

Figure 1.7. Mean monthly wind vectors over annual cycle in 1996: January (bottom arrow) through December (top arrow).

Magnitudes (speed) are greatest in western Santa Barbara Channel in summer.

(Dorman and Winant 2000)



Figure 1.8. The Santa Barbara Channel with bathymetric relief and satellite imagery to show topography.

Note the mountain ranges that steed the winds, creating the circulation patterns shown in [Figure 1.5](#).

Source: Google Maps.

1.2.2 Currents

Three main currents are discussed in the Southern California Current System (SCCS): the California Current (CC), an Inshore Current (IC) and the California Undercurrent (CU, also called the Davidson Current). The CC flows generally southward centered about 300 km from the coast with the IC flowing northward at the surface inshore of the CC. The CC is found in all seasons. The CC waters are characterized as a tongue of fresher, colder water advected southward from the north (Bray and Greengrove 1993; Bograd and Lynn 2003). The IC is strongest in summer and difficult to find in spring. The dynamics of the IC are related to positive wind-stress curl with an along-shore gradient (Oey 1999) (Di Lorenzo 2003b). The IC does not flow continuously around Point Conception. This intermittence of the IC has led to the

description of recirculation in the area as the Southern California Eddy (SCE). The CU flows northward subsurface, bringing warmer saltier water poleward. On the continental shelf, the SCCS is organized and well described while offshore dynamics are driven by eddy energetics at a variety of scales (Cheriskin and Trunnell 1996; Bray et al. 1999). The dynamics within the Bight are linearly driven by external forcing (Di Lorenzo et al. 2005).

Satellite height and temperature fields (Strub and James 2000) show the IC in spring and summer as a narrow jet next to the coast that initially matches the north-south distribution of equatorward alongshore winds. From spring through fall the IC moves offshore, developing meanders and forming closed eddies that shed and move westward. This eddy shedding matches measurement of higher Eddy Kinetic Energy (EKE) in the spring nearer the coast, moving offshore by the fall. Strub and James (2000) estimate the wavelengths of these eddies to be on the order of 300 km based on the distance of the largest meanders in the IC and the distance between the largest eddies. This is very different than the open North Pacific further offshore, where the wavelength is smaller, 100-150 km, with some longer wavelengths found in spring, which may be remnants of the coastal dynamics the previous year.

The annual dynamics of the SCB are best described starting in spring (Di Lorenzo 2003a). Upwelling favorable winds (from the north) cause the ocean density surfaces of SCB to rise along the coastline, initiating dynamics leading to the appearance of the IC. Moving into the summer season, upwelling favorable winds remain strong offshore. Denser water remains in the vicinity of the SCE because of the Bight's shape and winds. The curved shoreline and islands of the Bight trap the denser waters, and Ekman dynamics from the positive wind stress curl reinforces the collection of denser water in the SCE. This denser water anomaly progresses westward, reinforcing the cyclonic SCE, but becomes increasingly unstable through the summer as its core crosses the continental slope. The instability leads to eddy shedding, which moves the increased Eddy Kinetic Energy (EKE) west and offshore with the eddy drift. The EKE peaks in the SCE in late summer, and moves further offshore with the fully developed eddies. This new understanding is based on numerical experiments rather than observations, because the CalCOFI sampling spacing aliases the signal of these eddies (80 km, 3 month temporal resolution).

An unusual experiment in the spring (March-April) of 1995 captured the evolution of the spring "transition" of the CC (Lynn et al. 2003). The transition generally occurs quickly (one week or less), with dramatic changes in the surface current and water mass expressions. During the experiment, the water transitioned from the winter pattern of isotherms running perpendicular to the coast changing to the summer pattern of isotherms parallel to the coast. Surface water temperatures dropped between 1.5 and 4.0°C as the pattern shifted. Dynamic height shifted from an eddy-dominated winter flow to the appearance of both a coastal upwelling current (flowing equatorward at 20-30 cm/s) and a poleward strong coastal jet (core speeds of ~50 cm/s), which displaced the local eddy field. During this transition, the $\sigma_{\theta}=26.0$ isopycnal lifted over 60 m along the California coast, while dropping 10-40 m in offshore areas. This evidence suggests a "regeneration" of the CC, rather than the current simply moving offshore. These are not unusual circumstances, as the local upwelling index was within the normal range.

1.2.2.1 Santa Barbara Channel

The Santa Barbara Channel has been intensely studied both because of the complexity of the circulation and concerns related to potential oil spill trajectories. The Santa Barbara Channel is an area of complex bathymetry-topography with mountains along the northern coast, and four Channel Islands comprising the southern border. Though the channel is only about 100 km long and half as wide, there are Sea Surface Temperature (SST) and velocity gradients between the western and eastern entrances. A three-year mean for the western portion SST is about 13°C and mean currents 20 cm/s, while at the eastern entrance SST is about 16°C and 5 cm/s (Harms and Winant 1998). As mentioned above [in Section 1.2.1.1](#), the winds are highly variable (Dorman and Winant 2000) with a distinct seasonal cycle. This seasonal cycle in the currents is generally upwelling and eastward flow in the spring, strong cyclonic (counterclockwise) in the fall, poleward relaxation in the fall and variable circulation in the winter (Dever et al. 1998b), though views have expanded regarding the significance of external forcing (Oey et al. 2001; Di Lorenzo 2003b; Oey et al. 2004). For example, inner shelf currents north of Point Conception are highly correlated with winds while inside the Santa Barbara Channel the inner shelf currents are not correlated with the winds - with one exception, where a gap in the Santa Ynez Mountains at Gaviota Pass allows the winds through into the channel (Cudaback et al. 2005).

1.2.2.2 Santa Monica Bay

Santa Monica Bay, offshore of Los Angeles, is heavily polluted from local industry and agriculture. The Bay sits between Point Dume and Palos Verdes. Mean circulation in Santa Monica Bay in spring and summer is two counter-rotating gyres, with poleward flow in the northern gyres, and equatorward flow in the more southern gyre (Hickey et al. 2003). The spring mean surface velocities are into the bay at the surface. Transitioning from spring to summer, the currents change from predominantly equatorward flow in the spring to more poleward flow in the summer, with onshore flow weakening from spring to summer.

1.2.2.3 Upwelling

Upwelling is caused by wind-stress and buoyancy driven flow due to vertical density differences. The SCB has upwelling favorable winds throughout the year, but is sheltered strong wind forcing (Dorman and Winant 1995). In the SCCS, colder fresher water offshore meets colder, saltier upwelled water inshore (Levitus and Boyer 1994; Levitus et al. 1994). Thus the salinity budget in this upwelling system is a balance of horizontal advection of temperature and a vertical advection of salinity (Di Lorenzo et al. 2005).

Recent studies on the State of the California Current System (CCS) have recorded seasonal and interannual fluctuations in upwelling (Schwing et al. 2002; Peterson et al. 2006). Schwing et al. (2002) reported that 1998-2002 had the highest four-year mean upwelling index since 1946 (when data was first collected), and that there had been stronger than normal upwelling since the La Niña in late 1998 ([Figure 1.9](#)). The spring/summer of 1999 had the strongest upwelling on record, and this strong upwelling trend lasted into 2001-2002. The Santa Maria Basin is within this upwelling region, while the main SCB is sheltered and does not have the same level of variability. As upwelling winds have increased in the later part of the 20th century, one would expect the cross-shelf gradients to increase in salinity. However, coastal waters are warmer and

saltier, indicating reduced upwelling leading to reduced zooplankton (Roemmich and McGowan 1995b; McGowan et al. 2003).

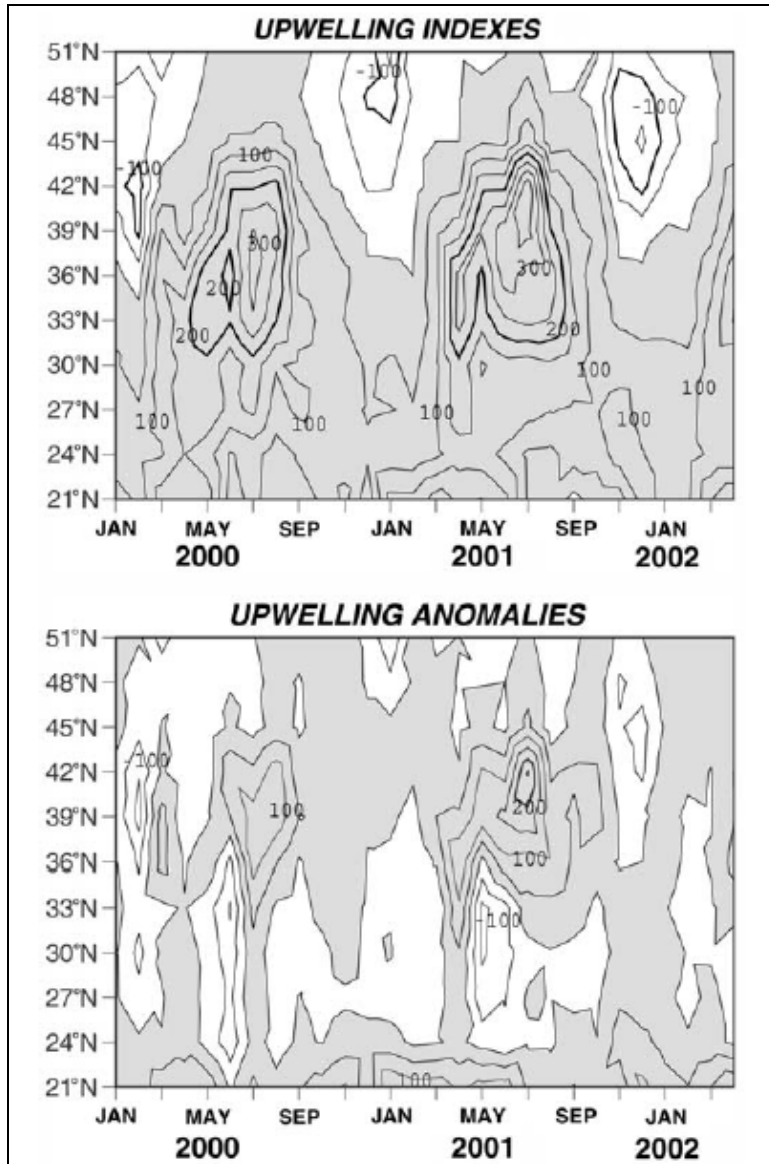

Figure 1.9. Monthly upwelling index and upwelling index anomaly for Jan. 2000 - Apr. 2002.

Shaded areas denote positive (upwelling-favorable) values in upper panel, and positive anomalies (generally greater than normal upwelling) in low panel. Anomalies are relative to 1947-68 means. Units are in m^3/s per 100km coastline.

Source: Schwing et al. (2002).

Though upwelling favorable winds have increased in recent decades, the increased stratification is related to a long-term warming trend (1.3°C over the CalCOFI period of 1949-2000, see [Figure 1.10](#)) (Di Lorenzo et al. 2005). The stratification blocks the effect of the upwelling favorable winds, as mentioned above. Reduced upwelling would lead to decreased surface nutrients available at the surface, which explains the decrease in zooplankton concentration over the time period. The increase in upwelling favorable winds also increases the strength of coastal currents. These factors lead to the suggestion that long-term stability properties in the SCCS have changed (Di Lorenzo et al. 2005).

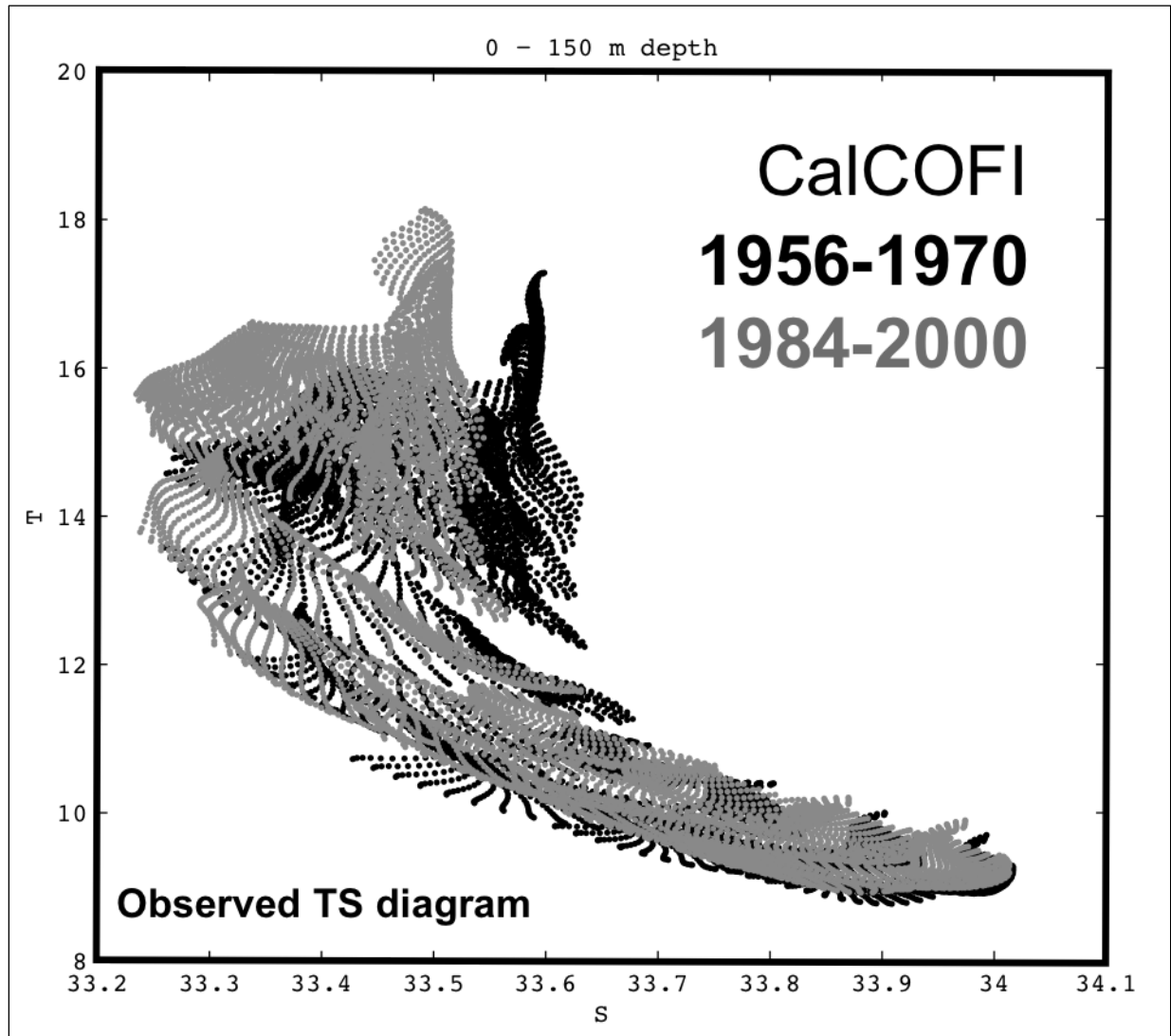

Figure 1.10. The T-S diagrams for water masses in the coastal upwelling region (0–100 km from the coast and 0–150-m depth) averaged for the period 1954–70 (black dots) and the period 1984–2000 (gray dots). (a) CalCOFI observations from.

(Source: Di Lorenzo et al. 2005).

1.2.3 Water Properties

Ocean temperature and salinity in the eastern Pacific are determined by the three source water masses and the air-sea energy exchange. The three primary sources are the North Pacific Subarctic Water (PSW), North Pacific Central Water (PCW) and the North Pacific Equatorial or Subequatorial Water (PEW). The water within the SCB is generally a mixture of PSW and PEW. The higher-salinity PCW is generally found offshore of the SCB. The seasonal trend for temperature and salinity in Southern California is fall/winter isopleths perpendicular to the shore, changing abruptly to isopleths parallel to the shore (Lynn et al. 2003) in spring/summer. Over the long term, temperature is well correlated with climate variability, while salinity is dominated by interdecadal variability (Di Lorenzo 2003b) ([see section 1.5](#) for further information).

A more detailed discussion of temperature and salinity during the spring transition is found above in [section 1.2.2](#) based on (Lynn et al. 2003). The NOAA National Ocean Data Center (NODC) Levitus World Ocean Atlas 1998 provides mean fields derived from 1990-1997 data with coverage in a 1.0 degree latitude x 1.0 degree longitude grid available for monthly, seasonally and annual time periods. CalCOFI also provides extensive data, including sections and surface contour maps in the annual data reports ([Figure 1.11](#)).

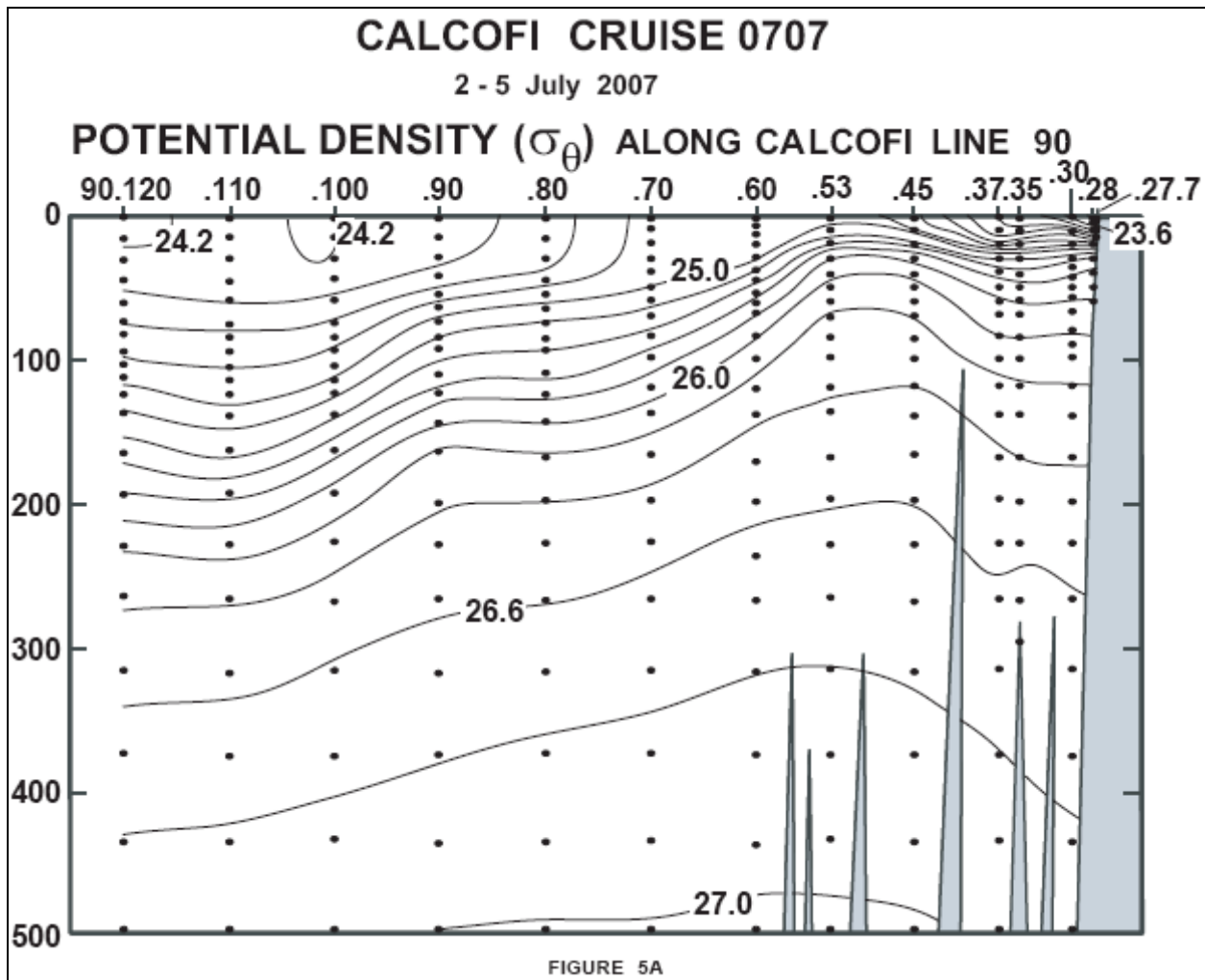

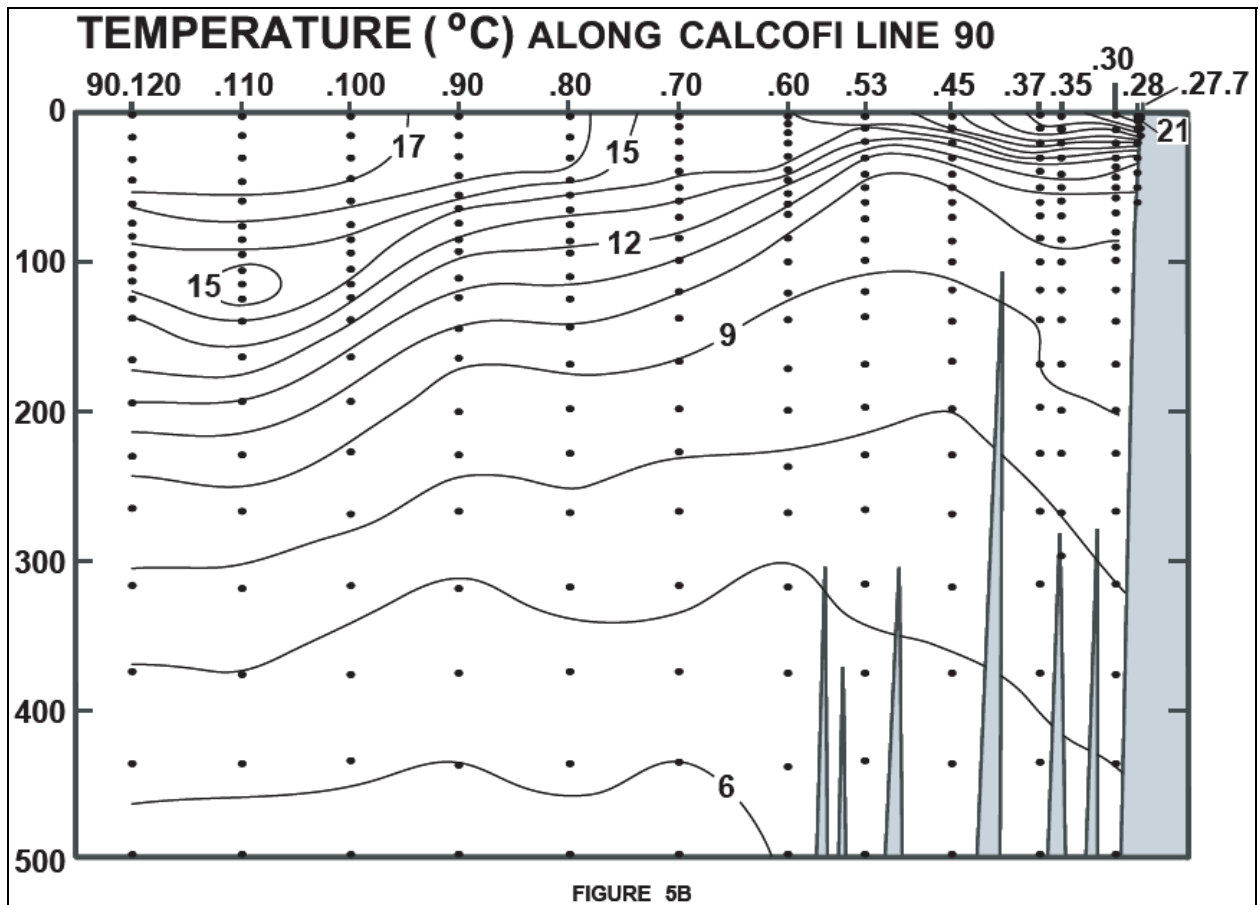

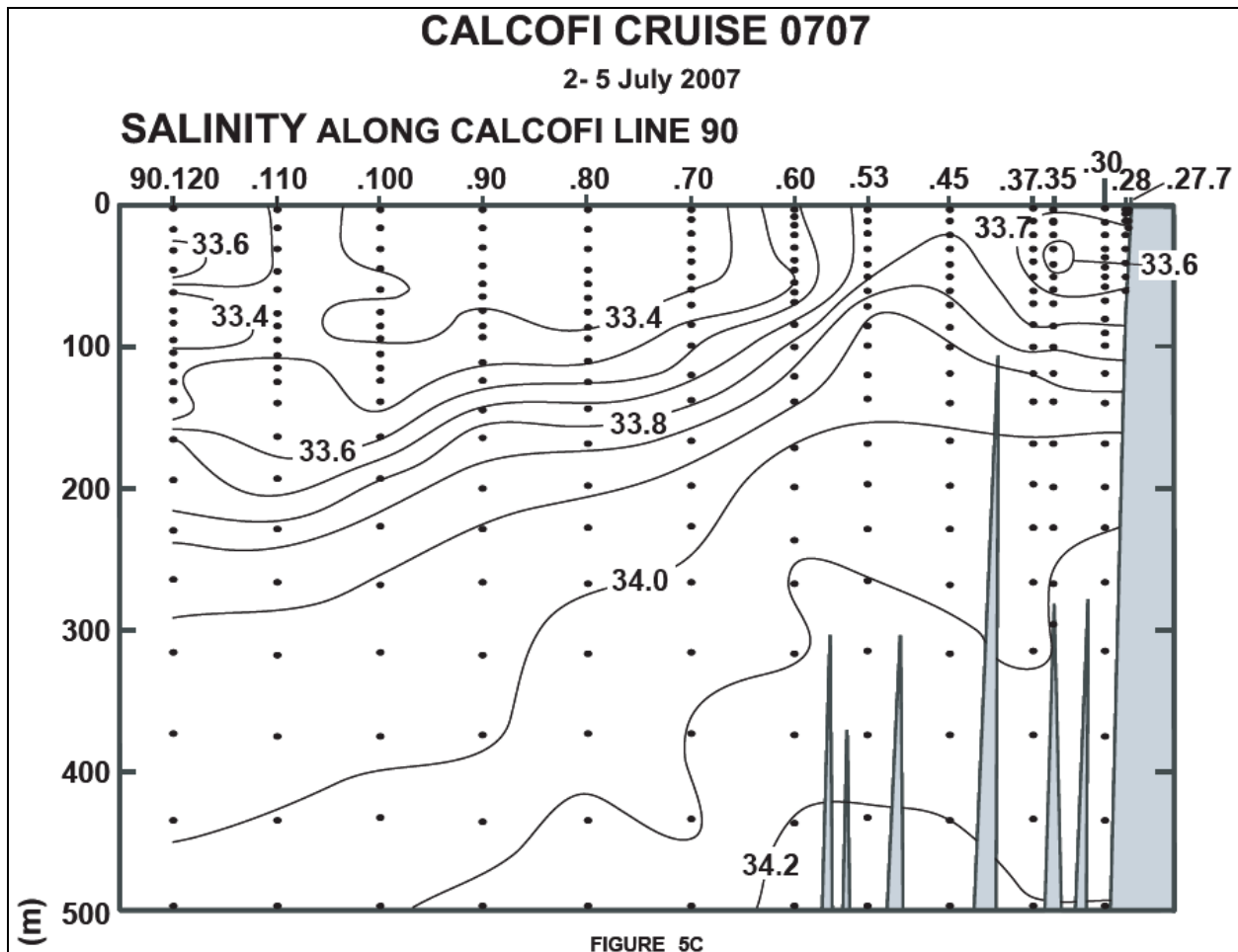

Figure 1.11. Sections of potential density, temperature and salinity along CalCOFI line 90 from the latest data report.

Cruise was 2-5 July 2007.

Source: (CalCofi 2008).

1.2.3.1 Temperature

The general temperature trend in the Southern Study Area is cooler water in the northern portion of the SCB and warmer water in the south. Warmer water enters the SCB from the south, while cooler water enters with the CC from the north. The seasonal range of temperature is about 12 °C to 19 °C at the surface. The range in temperature at the surface is larger at the surface (7 °C), with less variation at depth (about 4° C at 50 m) as shown in [Figure 1.12](#) (Hickey et al. 2003). Warmest temperatures are along the coast, with cooler temperatures offshore and deeper.

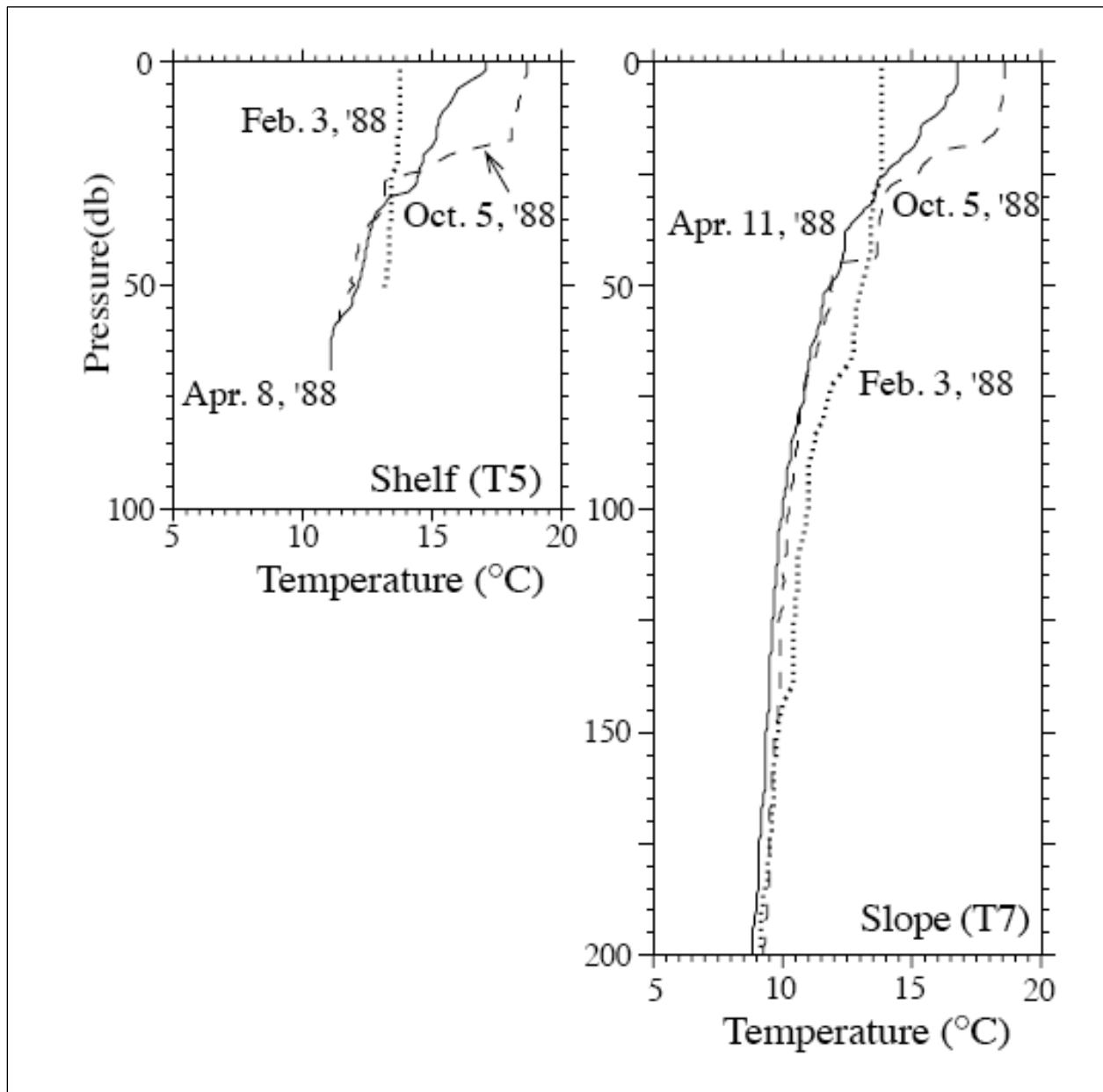

Figure 1.12. Seasonal cycle of temperature profiles in the shelf (left) and on the continental slope.

Source: (Hickey et al. 2003).

1.2.3.2 Salinity

Salinity has little intraseasonal variability; nearshore in July salinities are at about 33.6 and decrease to between 33.4 and 33.5 PSS in the late winter and early spring. Near the Cortes Ridge, salinities are 33.3 to 33.4 PSS. In general the upper layer of the water column in the SCB is nearly isosaline. Highest salinity waters are near the coast on the bottom ([Figure 1.11](#)), with moderate salinity water near the coast and lower salinity water offshore.

1.3 SUBTIDAL FLUCTUATIONS

1.3.1 Currents

Subtidal currents in the SCB are significant (10-40 cm/s) and fluctuate in magnitude and direction primarily on the time scale from 10-25 days (Hickey et al. 2003). These currents show relatively long period current fluctuations (> 10 days) with maximum energy with a period of 16 d 30 m (Hickey et al. 2003) to 14 d (Aquad et al. 1997). Hickey's major contribution to understanding these fluctuations is the concept of a large scale alongshore pressure gradient forcing. Subtidal disturbances propagate northward and account for about 40 percent of the variability throughout the year, and are more significant than local wind forcing, with the source indicated several hundred kilometers south of the SCB. More detail is provided below for the Santa Maria Basin and the Santa Barbara Channel.

1.3.1.1 Santa Maria Basin

Point Conception, where the coastline takes a sharp turn and topography begins to block the large-scale winds, is a transition point between the large-scale West Coast upwelling region from Washington through central California, and the milder conditions of the SCB and Santa Barbara Channel. The Santa Maria Basin is in the larger upwelling zone and circulation is correlated with local winds (Strub et al. 1987). Dever (2004) defines three patterns for circulation between the Santa Marina Basin and the Santa Barbara Channel ([see also Section 1.3.1.2 below](#)).

- *Upwelling Pattern* currents – equatorward flow with some offshore tendency in the Santa Maria Basin. Streamlines between Point Arguello and Point Conception divide circulation that flows southward past the west side of San Miguel Island and circulation that flows into the Santa Barbara Channel.
- *Surface Convergent Pattern* currents - a consistently poleward flow at depth from north of Point Conception along the mainland coast through the Santa Barbara Channel. However, at the surface the flow is weak equatorward north of Point Conception, and east of Point Conception the flow is poleward (westward). This means that the surface waters converge between Point Arguello and Point Conception, leading to offshore transport on the order of 100 km from the coast.
- *Relaxation Pattern* currents – almost the reversal of the Upwelling Pattern; most of the flow near the mainland of the Santa Barbara Channel continues past Point Arguello and northwestward to the Santa Maria Basin. Overall flow is weaker than during the Upwelling Pattern, and flow is weaker inshore of the 100 m isobath than offshore of that depth.

The times periods when each of these patterns is most likely to be found are:

- *Upwelling Pattern* occurrence: March and April, after the spring transition when SLP is still uniform, and the winds first become upwelling favorable.

- *Surface Convergent Pattern* occurrence: Summer with consistently strong upwelling favorable winds and SLP shows gradients typical of upwelling ([see section 1.2.1.1](#)).
- *Relaxation Pattern* occurrence: Late fall and early winter as the winds transition away from consistently being upwelling favorable.

1.3.1.2 **Santa Barbara Channel**

Though Harms (1998) originally put forward six canonical circulation patterns in the Santa Barbara Channel, three current regimes are currently used to describe the Santa Barbara Channel and the shelf area to the north: the Upwelling, the Surface Convergent and the Relaxation Patterns (Winant et al. 2003; Dever 2004). This is a modification and geographical extension of the original six patterns proposed by Harms (Dever et al. 1998a).

- *Upwelling Pattern* circulation - equatorward flow down to a depth of 45 m except close to the mainland where the flow is westward (poleward).
- *Surface Convergent Pattern* circulation- a consistently poleward flow at depth from north of Point Conception along the mainland coast through the Santa Barbara Channel. However, at the surface the flow is equatorward north of Point Conception, and east of Point Conception the flow is poleward (westward). This means that the surface waters converge between Point Arguello and Point Conception, leading to offshore transport on the order of 100 km from the coast.
- *Relaxation Pattern* circulation— almost the reversal of the Upwelling Pattern; the flow is also cyclonic, but the eastward flow along the northern Channel Islands is very weak.

The times periods when each of these patterns is most likely to be found are:

- *Upwelling Pattern* occurrence: March and April, after the spring transition when SLP is still uniform, and the winds first become upwelling favorable.
- *Surface Convergent Pattern* occurrence: Summer with consistently strong upwelling favorable winds and SLP shows gradients typical of upwelling ([see section 1.2.1.1](#)).
- *Relaxation Pattern* occurrence: Late fall and early winter as the winds transition away from consistently being upwelling favorable.

Cyclonic eddies commonly form in the Santa Barbara Channel during summer and fall. These eddies usually form between the central channel and the eastward entrance and drift westward slowly (Harms 1998).

1.3.2 Water Properties

1.3.2.1 Temperature

Warmer water is brought in to the SCB from the south, while cooler water is brought in from the north through the CC. Subtidal temperature changes are primarily related to changes in the alongshore pressure gradient (Hickey et al. 2003) mentioned above. Shifting the pressure gradient to brings warmer water poleward to the SCB, while the opposite changes bring colder water equatorward. Local upwelling leads to cooler temperatures directly near the coast about 3-5 times per year. Longer term upper ocean CalCOFI temperature trends are correlated with PDO (Di Lorenzo et al. 2005) while salinity is not ([see section 1.5.2 for further information on the PDO](#)). The concept of a large scale alongshore pressure gradient shifting the surface temperature field (Hickey 1993) suggests a connection between the PDO and this pressure gradient. Caldiera and Marchesiello (2002) investigate sheltering effects of Catalina Island which leads to warmer water in the Catalina Island ‘wake.’ They suggest that lateral advection as discussed in Hickey et al. 2002 describes the large-scale temperature variability, but suggest that the warmer water characteristic of the SCB is directly related to daytime heating of the sheltered waters.

1.3.2.2 Salinity

Higher salinity water is brought in to the SCB from the south, while lower salinity water is brought in from the north through the CC. On the Interannual scale, the salinity of the SCB is related to the balance of horizontal advection and wind-driven upwelling in the central and eastern portions of the North Pacific gyre through the NPGO (Schneider et al. 2005). Which are the same forces that control salinity in the CC and SCB on the annual scale ([see section 1.2.3](#)).

1.4 TIDAL AND SUPRATIDAL FLUCTUATIONS

The tides are the periodic raising and lowering of the sea surface created by the gravitational pull of both the Sun and the Moon along with the centrifugal forces of the Earth/Moon and Earth/Sun rotating systems. Because the orbits of the Moon around the Earth and the Earth around the Sun are both elliptical and at a declination, the potential of the tide-producing forces at a specified location on Earth's surface encompasses many frequencies with different magnitudes. Each of these frequencies is labeled as a tidal constituent. Approximately 380 frequencies have been identified although most can be ignored, since either their amplitudes are insignificant and/or their frequencies are high. The two dominant tidal constituents along the Southern Study Area are the M_2 principal lunar semi-diurnal and K_1 luni-solar diurnal.

The change in sea level associated with the tides acts like a shallow water wave propagating over the ocean basins since their wavelengths are on the order of thousands of kilometers. These “tidal” waves are refracted by the sea floor and constrained by the continents. The result is a complex tidal system called the amphidromic system. There is a separate amphidromic system for each tidal constituent. In the North Pacific Coast there are semi-diurnal and diurnal amphidromes associated with the M_2 and K_1 constituents (Luther and Wunsch 1975). Both the M_2 and K_1 tides move as barotropic Kelvin waves around the amphidrome in a counterclockwise direction so that they propagate from south to north along the West Coast of North America. For other constituents the amphidrome can be located in different locations and the tidal propagation

can be either clockwise or counterclockwise. “Tidal” waves act like shallow water waves in that a particle of water on the surface of the ocean follows a vertically oriented elliptical path – when the crest of the wave passes over a fixed location the particle moves forward and when the trough of the wave passes the particle regresses. The particle of water also has a component of motion perpendicular to the direction of the propagating wave, tracing out a horizontal ellipse. The resulting sea surface motions are the tidal currents. The elliptical patterns traced by tidal motions are different than “tidal ellipses” that mentioned in the literature. “Tidal ellipses” are the ellipse traced out by the vector describing the tidal motion.

The Internal Waves on the Continental Margin (IWAVES) experiment (1996-1997) studied internal waves near Mission beach north of San Diego (Figure 1.13). The goal was to study internal waves along the continental slope and shelf at three different time scales: diurnal, semi-diurnal and high frequency (periods less than 1 hour) (Lerczak 2000). Seabreeze commonly forces the diurnal internal waves (frequency = 1 cpd) (Lerczak et al. 2001a; Lerczak et al. 2001b; Lerczak et al. 2003). At 37°N latitude, the local inertial frequency is close to diurnal; so significant motions are expected, leading to significant energy transfer into the ocean. The barotropic tide interacts with the complex bathymetry in the SCB leading to large isopycnal (constant density) displacements and changes in the currents in the semi-diurnal frequency that are larger than the local barotropic currents. The internal tide currents has a nonzero mean, so these currents could not be separated from the surface tidal currents (Lerczak et al. 2003). Higher frequency internal waves were observed to regularly propagate onshore in the vicinity of the study.

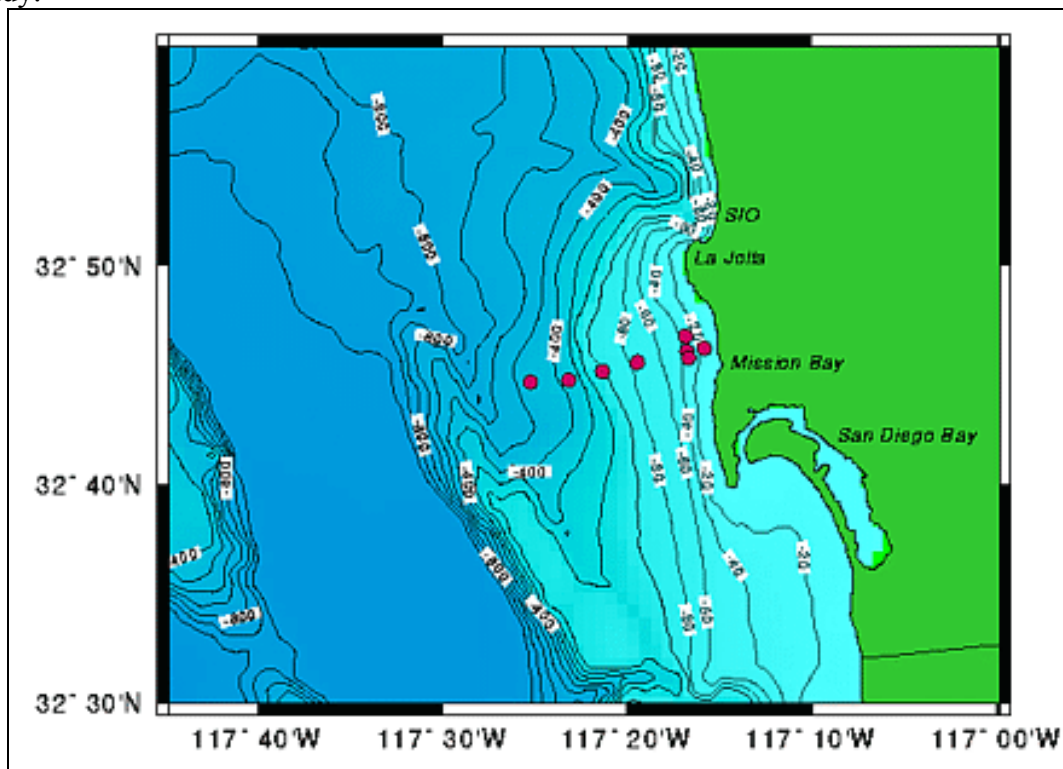

Figure 1.13. IWAVES currents meter deployment array.

From IWAVES website, <http://iod.ucsd.edu/research/iwaves/>.

Infragravity waves (ocean surface gravity waves, period = 20 to 200 s) moving onto the continental shelf north of San Diego were investigated north of San Diego near the Scripps Institution of Oceanography (Thomson et al. 2005; Thomson et al. 2006; Thomson et al. 2007) near two submarine canyons (Figure 1.14). These infragravity waves are generally seen as modulations to the large surface gravity waves incident on coastline (period= 10 to 20 s). These waves are involved with longshore circulation and sediment transport (Thomson et al. 2006). When incident on the beach, energy loss from these waves is higher on the low tide beach, than on the steeper high tide beach. In waters 15 m or less, the interaction of ocean surface gravity waves transfers energy from low-frequency (infragravity) back to high frequency more effectively over the flatter, low tide surf zone (Thomson et al. 2006). Submarine canyons act to both refract and reflect infragravity waves (Thomson et al. 2007).

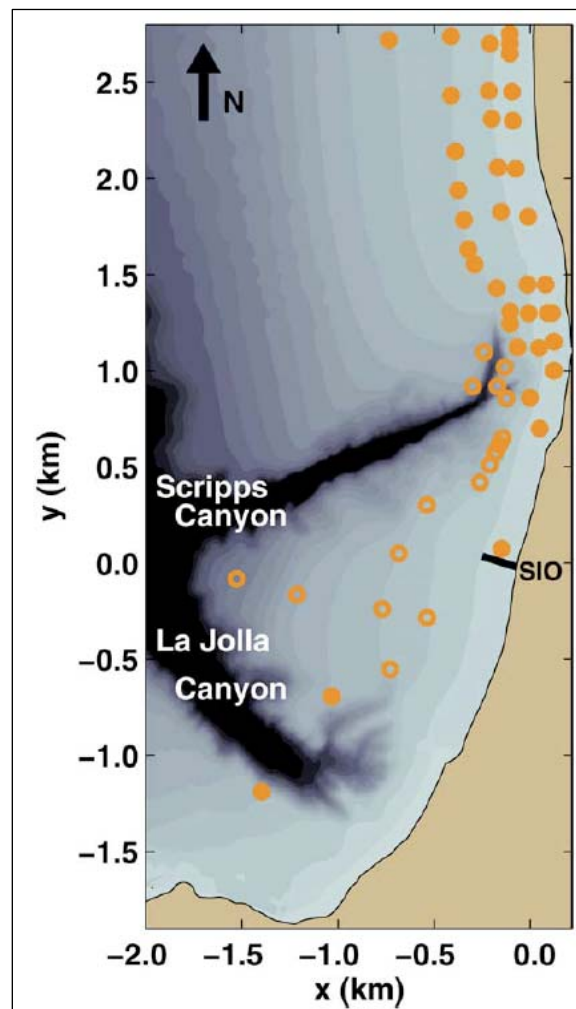

Figure 1.14. Diagram of bathymetry (dark > 100 m) and instrument array (symbols) used in the investigation of infragravity waves.

From (Thomson et al. 2007).

1.5 INTERANNUAL FLUCTUATIONS

The dynamics of the Southern California Current System change at a variety of longer timescales. In the last couple of decades there has been an increased number of publications on large-scale interannual climatic fluctuations. Observations of these fluctuations have been made possible by the growing length of data sets that are now able to resolve long period decadal oscillations. The advent of new technologies such as remote satellite sensing and increased interest in climatology due to global warming has also aided the progress toward understanding these fluctuations. Still, evidence of some fluctuations is weak. The periods of many climatic fluctuations that have been observed are on the order of multiple decades, which are still difficult to resolve. Many of the oscillations are statistically derived and their dynamics are often not completely understood.

The interannual fluctuations that are covered in this section and affect the Southern Study Area are the El Niño Southern Oscillation (ENSO), La Niña Southern Oscillation, Pacific Decadal Oscillation (PDO), and the North Pacific Gyre Oscillation (NPGO). Since these oscillations affect seasonal variability, they are also covered in [section 1.2](#), Seasonal Patterns. A number of indices are used to identify interannual fluctuations. These indices use a combination of atmospheric and oceanographic observations such as sea surface temperature (SST), atmospheric sea level pressure (SLP), upper atmospheric pressure, sea level, precipitation, wind patterns etc. The most commonly used climatic indices are the Multivariate ENSO Index (MEI, Figure 1.15), Southern Oscillation Index (SOI) and the North Pacific Index (NPI). The MEI is used in correspondence with the ENSO and the NPI is used in correspondence with the PDO. As new data are collected and new analyses performed, more oscillations and indices are being discovered and presented in the literature. This section focuses on the predominant and widely accepted oscillations and indices.

Understanding these fluctuations in the atmosphere and ocean can aid in understanding changes in the biota that may not have an obvious cause. For example, Funes-Rodriguez (Funes-Rodriguez et al. 2006) found that mesopelagic fish larva along the coast of Baja could be grouped according to affinities for tropical, subtropical and temperate conditions. Combinations of these groups could be linked to ocean and climate parameters (plankton biomass, SST anomaly, upwelling and a multivariate El Niño index). Variations in abundance of the tropical and temperate groupings were related to the El Niño/La Niña cycle. Another example is the warming of the surface waters and the increased stratification of the water column over the CalCOFI time series inhibited upwelling (discussed in detail below), which most likely lead to the observed decrease in zooplankton biovolume seen in the SCB (Roemmich and McGowan 1995b; McGowan et al. 2003; Hsieh et al. 2009). The larger-scale North Pacific gyre cycles may be explained by a combination of the PDO and the North Pacific Gyre Oscillation (NPGO) (Di Lorenzo et al. 2008), as the NPGO is related to large scale chlorophyll-a distribution, which has been linked to fish catch (Ware and Thomson 2005; Rykaczewski and Checkley 2008). Lluch-Cota (Lluch-Cota et al. 2001) discussed long-term regime shifts that match the sardine abundance cycles (higher during warm periods, and much lower during cooler periods). Mantua (Mantua et al. 1997) showed relations between the Pacific Decadal Oscillation (PDO) and salmon “boom and bust” cycles. Understanding the physical environment is important for environmental management.

The National Climatic Data Center (NCDC) maintains an extensive resource on global and local climatology that is available to the public (<http://www.ncdc.noaa.gov>). Among the many resources available are up to date monitoring of ENSO, teleconnection indices, SST, reports and discussions. Archived climatic data is also available.

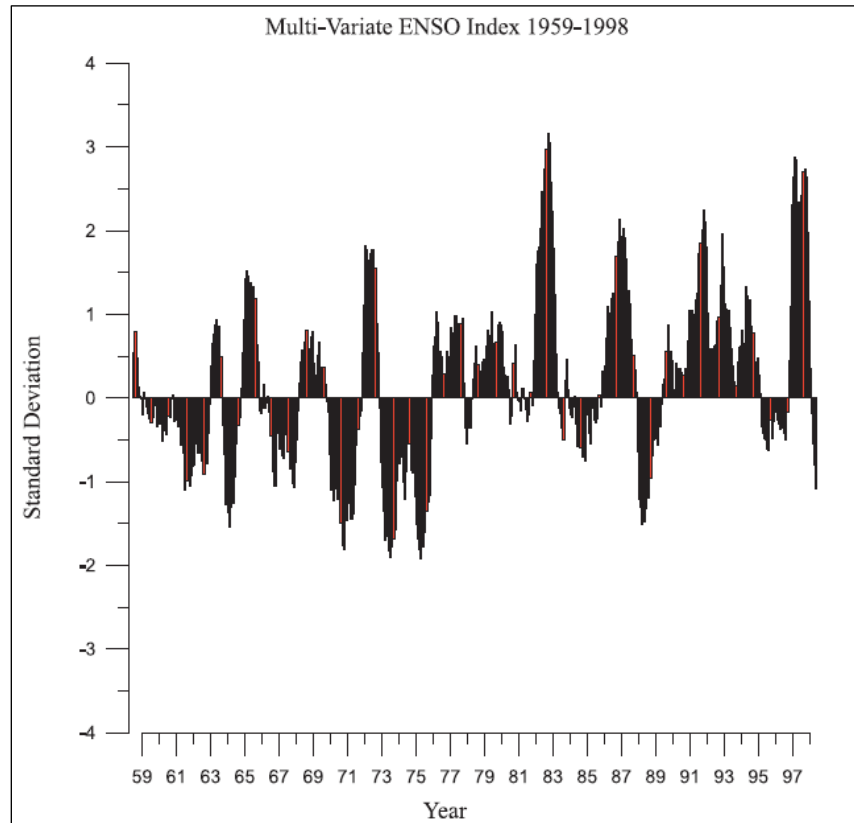

Figure 1.15. Multivariate ENSO Index from 1959-1998.

Positive (negative) standard deviations indicate El Niño (La Niña).

From Shinker and Bartlein (2009) (c)American Meteorological Society.
Reprinted with permission.

The literature often uses the term “teleconnections” which refers to the concept that climate anomalies in one location may be related to the climate in distant locations through the occurrence of particular global-scale anomalies in atmospheric circulation (Shinker and Bartlein 2009) (Redmond and Koch 1991). Redmond and Koch (1991) identified two teleconnection patterns, the Southern Oscillation and the Pacific-North America (PNA). The PNA has been observed as one of the dominant modes and its upper level atmospheric pattern consists of a deeper-than-usual Aleutian Low pressure center, an intensified ridge of high pressure over western North America, and a negative pressure anomaly at upper levels over the southeastern United States.

1.5.1 El Niño

The ENSO is the occasional appearance of warm water off the coast of Peru (Wyrski 1975). The arrival of these warm waters is due to the relaxation of typically persistent tropical easterly winds, which causes an eastward propagation of warm waters acting as an equatorially trapped Kelvin wave. In addition to the equatorial east Pacific, El Niños have a large scale influence on the entire Pacific Ocean including the northwest coast. Strong El Niños are associated with anomalous heavy precipitation along the California and southern Oregon coasts and anomalous low precipitation along the Washington coast. Based on the MEI ([Figure 1.15](#)) the five strongest El Niños in order of strength occurred in 1982-83, 1997-98, 1991-92, 1986-87, and 1972-73 (Shinker and Bartlein 2009). The strongest La Niña years in order of strength were 1974-75, 1971-72, 1988-89, 1964-65, and 1962-63. In the Southern Study Area, sea surface temperatures and temperatures over land are generally higher during El Niño years. Warmer sea surface temperatures are partially due to northward-propagating coastally-trapped Kelvin waves (Meyers et al. 1998). These warmer land surface temperatures are influenced both by warmer sea surface temperatures, and a lower latitude storm track that entrains warmer and moister subtropical air.

Shinker and Bartlein (2009) used time-series maps of the following variations in the large-scale climatic controls and surface responses during strong positive (El Niño) and negative (La Niña) phase ENSO events to assess variations in climate anomalies: temperature, mean sea level pressure, 500-mbar geopotential heights, 500-mb Omega (vertical velocities), and 850-mb specific humidity. [Figure 1.16](#) shows composite anomalous mean sea level pressure for strong positive and negative ENSO events. Typically, the surface North Pacific high pressure center expands during summer months. During El Niño years, lower than normal high surface pressure is found over the eastern North Pacific particularly during winter months ([Figure 1.16](#)) (Shinker and Bartlein 2009). This reflects the increased intensity and drop in latitude of the storm track that cause a decrease in upwelling-favorable winds off the California coast and an increase downwelling-favorable winds off the Washington coast. In contrast, La Niña years show anomalously high pressure over the eastern North Pacific, which would increase upwelling-favorable winds and cool sea surface temperatures.

Mean 500-mbar geopotential heights charts show the strength of the trough and ridge patterns in the upper atmosphere (not pictured). This helps determine the position and strength of the jet stream. The jet stream is typically associated with the storm track. A deepening and expansion of the trough in the North Pacific basin occurs during December through March of El Niño years (Shinker and Bartlein 2009). The deepening of the trough is indicative of intensification of storms and the expansion of the trough is indicative of a more southerly track of the jet stream.

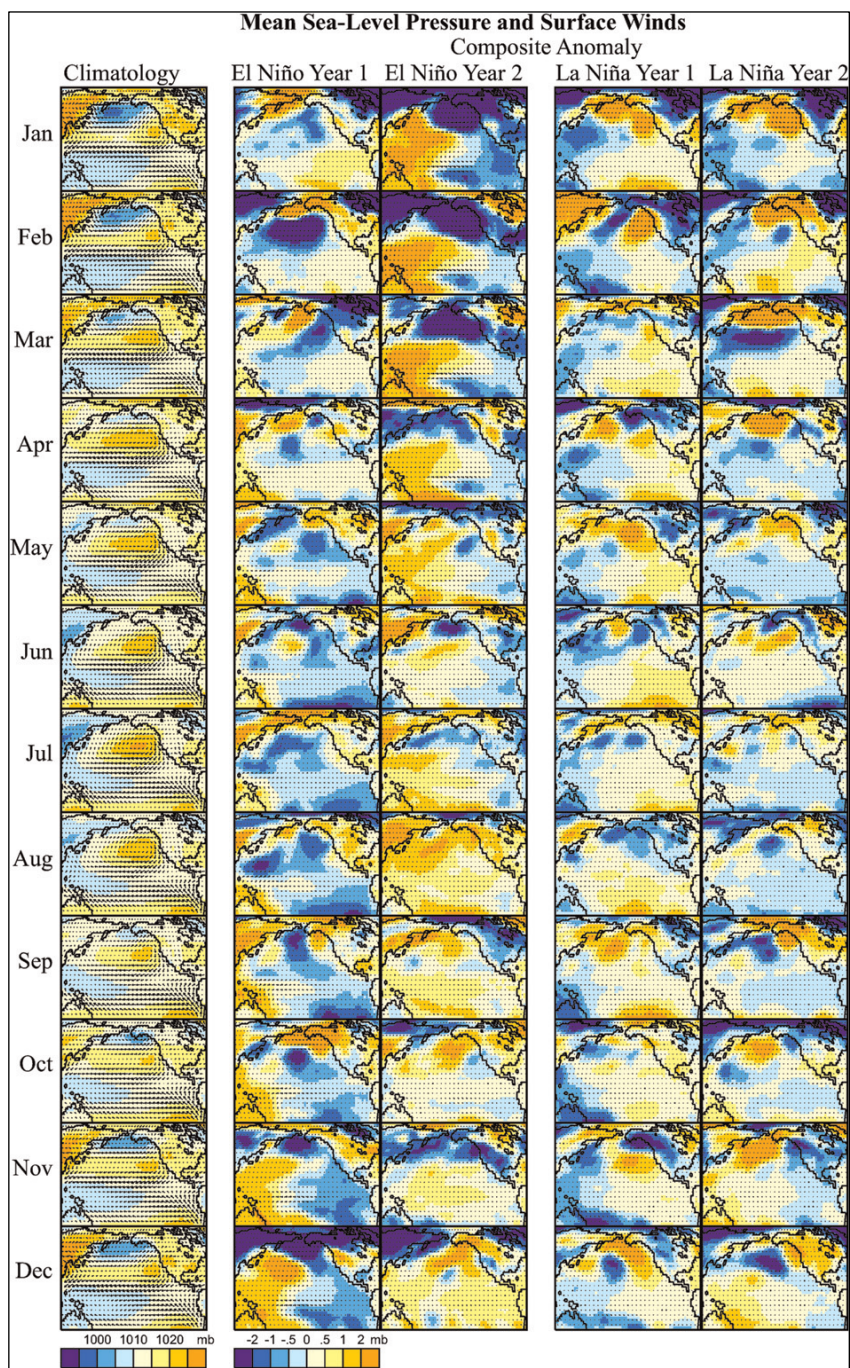

Figure 1.16. Mean sea level pressure with surface wind vectors climatology and composite-anomaly maps for El Niño and La Niña years.

Base period 1959-97. Blue (orange) indicates low (high) sea level pressure in the climatology column and anomalously low (high) in the El Niño and La Niña columns.

From Shinker and Bartlein (2009) (c) American Meteorological Society. Reprinted with permission.

The 500-mbar level is often referred to as the “level of nondivergence.” Here flow is generally geostrophic (pressure gradient force in balance with Coriolis force) and vertical velocities can be inferred from surface and upper-level divergence fields. Large-scale rising motions in the atmosphere (positive 500-mbar Omega) are associated with precipitation, whereas sinking motion suppresses precipitation. Although 500-mbar Omega values do not show as strong a contrast between El Niño and La Niña years, there is evidence of weak vertical velocities north of the mid-Pacific basin which account for the relatively dry climate off Washington during El Niños (Shinker and Bartlein 2009). Vertical velocities during La Niñas did not have a strong coherent structure. Mean 850-mbar relative humidity can be used along with mean vertical velocity to highlight precipitation trends.

In Southern California, periods of strong El Niño are associated with higher rainfall, increased stormwater flow, and higher fecal coliform bacteria in the surf zone (Boehm et al. 2004). ENSO does not affect the West Coast of North America equally (Lluch-Cota et al. 2001). North of 31 deg N latitude (close to the United States / Mexico Border), the correlation of ENSO between SST decreases at higher latitudes, but ENSO correlation with sea level effects is seen north to the Gulf of Alaska. Significant features in tropical atmospheric circulation are mostly determined by SST (Neelin et al. 1998).

1.5.2 Pacific Decadal Oscillation

Chao et al. (2000) analyzed a long time series of sea surface temperature data, finding an interdecadal oscillation of 14-17 years. The time series shows regime shifts symmetric across the equator in 1924-1925, 1941-1942, 1957-1957, and 1976-1977. A longer period mode of approximately 70 years appears to be in the record, but required further study with longer time series to discern.

The PDO has been described as a long-lived El Niño-like pattern of the Pacific climate variability, and as a blend of two, sometimes independent, modes having distinct spatial and temporal characteristic of sea surface temperature in the North Pacific (Mantua and Hare 2002). Mantua and Hare (2002) report that several studies have found two “cool” PDO regimes which occurred from 1890-1924 and 1947-1976, and two “warm” PDO regimes which occurred from 1925-1946 and 1977-1995. The bottom of [Figure 1.17](#) shows average PDO Index values and the general shape of the oscillation. During warm PDO phases, sea surface temperatures (SST) tend to be anomalously cool in the central North Pacific while anomalously warm SST occurs along the West Coast of North America ([Figure 1.17](#)). Mean sea level pressure (SLP) and wind stress anomalies during the winter of warm PDO show a stronger low pressure signal along with enhanced cyclonic circulation. This is due to increased intensity or increased frequency of low-pressure midlatitude cyclonic storms.

The climatic anomalies associated with the PDO are similar to the ENSO, although not as extreme. Warm phases of the PDO coincide with anomalously dry periods along the Washington coast and across the northern Great Plains and wet periods along California and Alaska coast. Warm phase PDO temperature anomalies show warm temperatures along the West Coast that get warmer toward Alaska. The PDO exhibits large-scale SST variability that affects

the entire North American West Coast. Whether these effects are driven by local changes or larger-scale changes in the North Pacific current system is unknown. Upper ocean CalCOFI temperature trends are correlated with PDO (Di Lorenzo et al. 2005) while salinity is not. Sea surface temperature may be locally forced (wind, heat flux), while salinity is affected more remotely. The concept of a large-scale alongshore pressure gradient shifting the surface temperature field (Hickey 1993) suggests a connection between the PDO and this pressure gradient.

As mentioned by Mantua and Hare (2002), there is compelling evidence for connections between the PDO and Pacific marine ecosystems. Studies have documented a strong jump in groundfish stocks coincident with the 1976-77 regime shift, Pacific halibut recruitment has been shown to undergo interdecadal shifts correlated with PDO, and several flatfish species exhibit recruitment frequencies similar to the PDO.

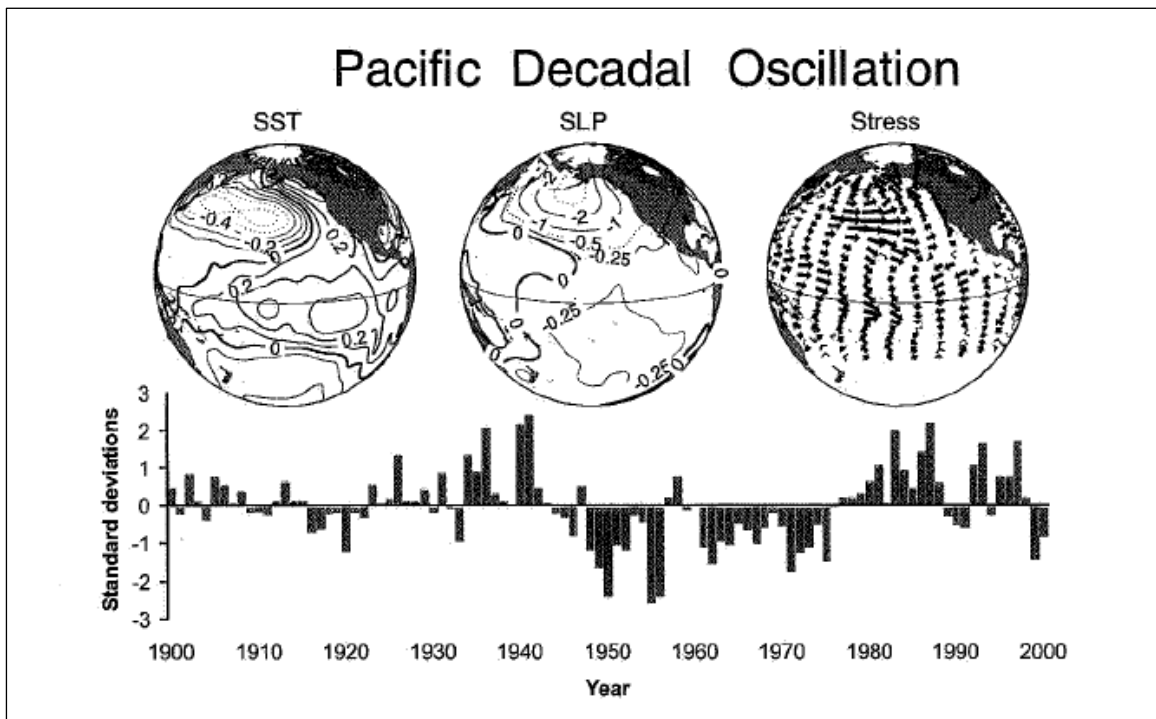

Figure 1.17. (top) Anomalous climate conditions associated with warm phase PDO, and (bottom) November-March average values of the PDO Index.

Values shown are °C for SST, millibars for SLP, and direction and intensity of wind stress. The longest vectors represent a pseudostress of $10 \text{ m}^2/\text{s}^2$.

From Mantua and Hare (2002).

The PDO and ENSO have not been able to explain all fluctuations along the northwest coast. The North Pacific Gyre Oscillation (NPGO, [section 1.5.3](#)) has recently been found to correlate with previously-unexplained fluctuations in salinity, nutrients, chlorophyll, and fish populations (Di Lorenzo et al. 2008). The first mode of the positive PDO shows a large cyclonic gyre in the North Pacific, that reflects downwelling-favorable winds along the northwest coast ([Figure 1.18](#)).

This pattern does not explain the upwelling-favorable conditions observed along the California coast. The positive NPGO, however, manifests two gyres, a cyclonic gyre to the north and anticyclonic gyre to the south (Figure 1.18). This acts to increase the transport of the Alaskan Coastal Current and the California Current. The upwelling-favorable pattern of the positive NPGO implies that latitudes south of 38° N along the California coast could exhibit strong biological productivity due to upwelling-favorable winds despite the appearance of positive PDO patterns, which are associated with low productivity.

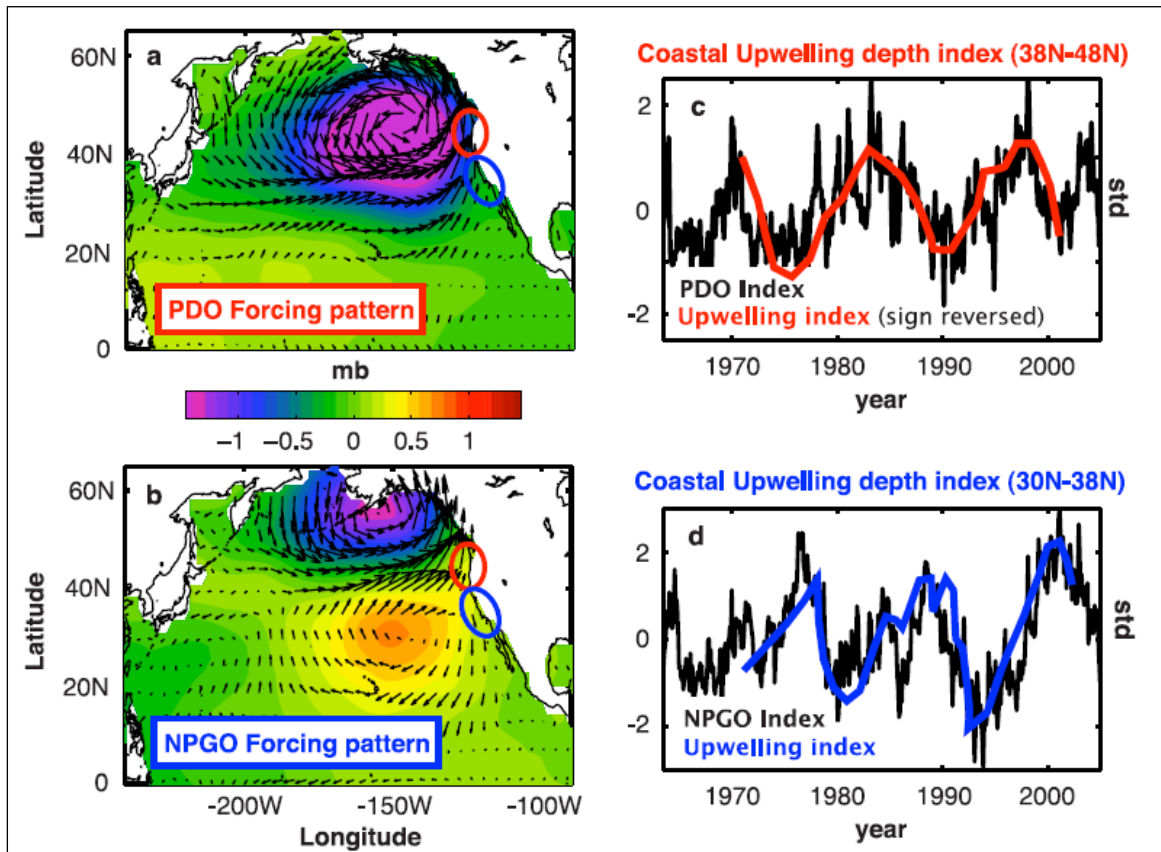

Figure 1.18. Atmospheric forcing patterns of the PDO and NPGO modulate decadal changes in coastal upwelling.

Regression maps of (a) PDO and (b) NPGO indices with NCEP wind stress vectors and sea level pressure (color scale). (c) Coastal upwelling depth index from inverse model calculations averaged from 38N to 48N (area denoted by red circles) compared to PDO index. (d) Coastal upwelling depth index from inverse model calculations averaged from 30N to 38N (area denoted by blue circles) compared to NPGO index. A positive upwelling index indicates a deeper upwelling cell.

(Source: Di Lorenzo).

1.5.3 North Pacific Gyre Oscillation

A newer index of variability in the North Pacific is the North Pacific Gyre Oscillation (NPO) (Di Lorenzo et al. 2008). The NPGO is the climate cycle most related to changes in salinity,

nutrients and chlorophyll-a in the California Current (Di Lorenzo et al. 2008), and so may be related to catch cycles in fisheries along the U.S. West Coast. The value of the NPGO Index is related to the balance of horizontal advection and wind-driven upwelling in the central and eastern portions of the North Pacific gyre. These are the same forces that control salinity in the CC and SCB (see section 1.2.3). Along the West Coast of the United States, the PDO dominates north of the 38°N latitude (between Napa and San Francisco, California), while south of this latitude, the NPGO dominates. So the SCB dynamics show more response to the NPGO than the PDO. Potentially, major North Pacific regime shifts may occur when the PDO and NPGO evidence strong and opposing changes simultaneously.

The PDO is the first Empirical Orthogonal Function (EOF, spatial mode) and first Principle Component (PC, temporal mode) of North Pacific (180°W-110°W, 25°N-65°N) for Sea Surface Temperature anomalies (SSTa) and Sea Surface Height anomalies (SSHa), while the NPGO is the second Principal Component. Thus the NPGO is orthogonal to temperature and thus is independent of the PDO. The NPGO is significantly correlated with North Pacific Sea Surface Salinity anomalies (SSSa), chlorophyll-a, and subsurface NO₂, PO₄, SiO₄ and O₂ concentrations (see Figure 1.19), while the PDO is not. Temperatures below the mixed layer in the SCB correlate well with ENSO and PDO variations (Mantua et al. 1997; Schneider et al. 2005) and local upwelling.

Salinity in the SCB is known to vary on interdecadal time scales (Schneider et al. 2005). Salinity anomalies in the SCB are also not related to the local ocean surface dynamics. This relationship may be due to meandering and variations in intensity of the CC that cause these salinity changes (Di Lorenzo et al. 2005), where increased transport of fresher water masses in the CC core results from upwelling favorable winds. While these same winds in the nearshore would normally bring the warmer, saltier water of the CU to the surface, the increase in stratification due to the long-term temperature increase inhibits that action. Long-term studies of SCCS (Bograd and Lynn 2003) indicate significance to freshening (lowering of salinity) of the surface waters. This freshening is stronger inshore than in offshore areas, indicating that upwelling of saltier water from the CU is less effective.

1.5.4 Longer Period Cycles

As mentioned above, the SCB changes on many time-scales. MacCall (1996) describes shifts between two distinctly different circulation regimes as a 50-70 year cycle, with individual (and alternating) regime shifting events occurring in 1910, 1940 and 1976-1977, thereby defining a 67-year span between the first shift and the return. Using a longer time-series, Lluch-Cota (Lluch-Cota et al. 2001) describe these regime shifts as more gradual changes with variable interim periods. They describe shifts in the 20th century occurring in the early 1910s, the early 1940s, and mid-1970s, with suggestion of similar shifts around 1860, 1880 and 1900 (Lluch-Cota et al. 2001). The atmosphere and ocean are a coupled system, so when examining information such as the 1980 shift to more positive wind stress curl (Di Lorenzo et al. 2005), the more expanded time frame of these shifts is probably more descriptive of the system as a whole. Schwing et al. (2002) suggest another regime shift around 1998. As mentioned above, major North Pacific regime shifts may occur when the PDO and NPGO evidence strong and opposing changes simultaneously.

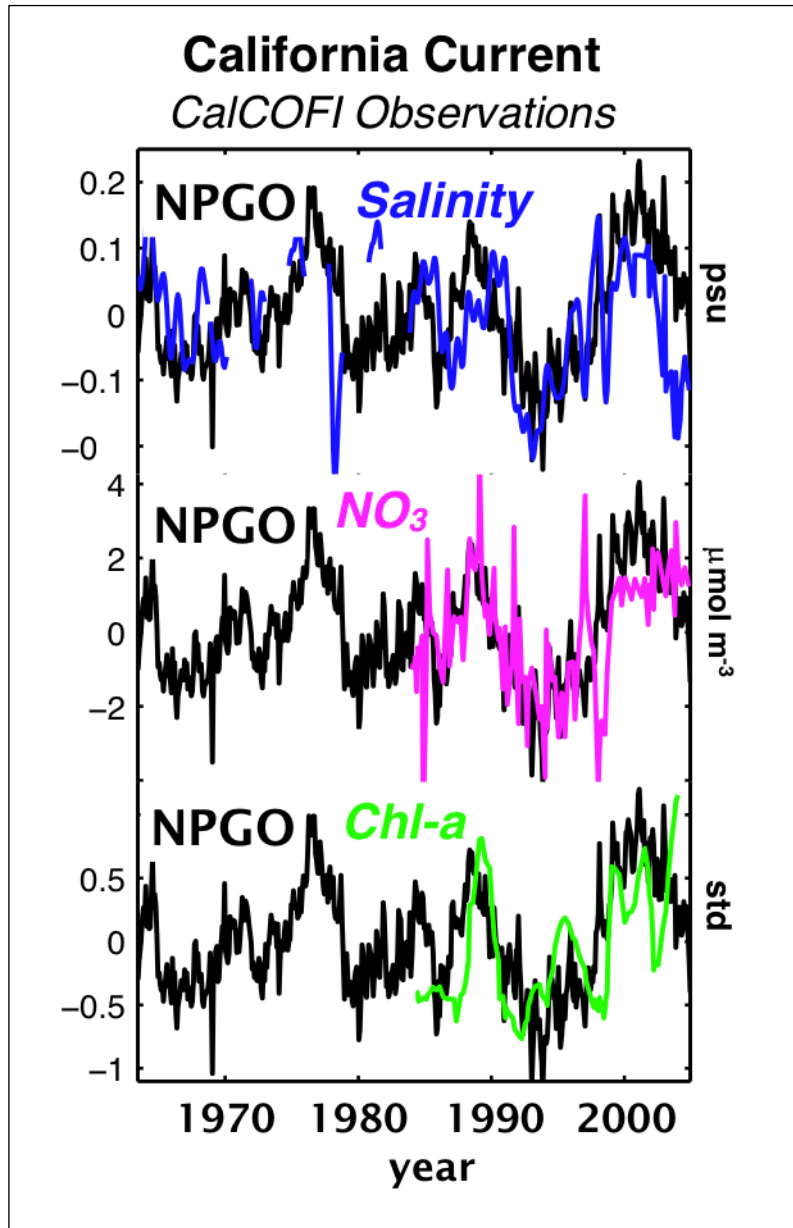

Figure 1.19. A comparison of the NPGO cycling with the CalCOFI salinity, nutrient and chlorophyll measurements,

(Source: Di Lorenzo 2008)

Fifty-one-year NCEP wind stress curl anomalies show a trend of more negative wind stress curl before 1980, and more positive curl after 1980 (Di Lorenzo et al. 2005), while model results indicate intensification of the southward CC after 1980. Coastal alongshore winds have increased over past decades, which should and increase upwelling and decrease SST, but does

not match the observed increasing SST trend. SST warmed approximately 1°C from 1950-1999 along coastal Southern California (Bograd and Lynn 2003). Along the 26.4 isopycnal ($Z_{26.4}$, generally between 180-220 m), which is always below the mixed layer, evidences a warming trend of 1.3°C and deepening of 18 m over last half of 20th century, (Di Lorenzo et al. 2005). Salinity only shows a weak negative trend (-0.03 PSS) that is smaller than standard deviation in record. Increases in thermocline depth and increasing stratification were related to a decrease in zooplankton (Roemmich and McGowan 1995b; Roemmich and McGowan 1995a; McGowan et al. 2003). This combination of thermocline deepening and increasing stratification developed from 1950-1999, with an increase in SST leading to decreased upwelling efficiency, even though there has been an increase in upwelling favorable winds. This resultant increase in alongshore winds intensifies CC. These combine to increase the circulation of the SCE based on CalCOFI data (Di Lorenzo et al. 2005).

1.6 BASIN WATER RENEWAL

The sea floor of the SCB is made up of a series of basins with sills. This configuration starts well south of Ensenada, Mexico, becoming more complex as the shelf widens from south to north with the basins oriented generally northwest-southeast. Generally, the basins shoal poleward, so deepwater flow for renewal moves from south the north. The exceptions are the Santa Barbara Channel, which renews bottom water from the west because of the blocking to the south by the Channel Islands, and the Tanner Basin, which also renews from the west. Less obvious is the influx of cooler water into the Santa Monica Basin through the western sill (Ledwell and Hickey 1995)

The Hickey (1993) discussion of the deep basins set the stage for generally seasonal water renewal for the outer (western) basins related to upwelling with some episodic “flushing.” Berelson (1991) discusses episodic renewal for the San Pedro and San Nicolas basin on interannual timescales. The concept of periods of flushing, such as from 1982-1984, and periods of stagnation (1984-1987) indicate the importance of climate in controlling the renewal of bottom water in these basins. In later experiments (Ledwell and Hickey 1995) renewal events in April and May of 1987 and in May 1988 showed recovery to near-normal conditions in one to two years. Subtidal analysis indicates that the period between these large renewal events is punctuated by smaller events. Renewal events appear to relate to strong upwelling events in the Santa Barbara Channel (Hickey 1993). There is potential that the set down (forced lowering) of sea level toward the east end of the Santa Barbara Channel may lead to a rise in sea level in the Santa Monica Basin (Harms 1996), resulting in a pressure gradient forcing water northwestward over the sill. Southeastward flow from the Santa Barbara Channel is typically associated with major upwelling events in the Santa Barbara Channel and strongly correlated with northwestward flow over the sill into the San Pedro and Santa Monica basin (Hickey 1993). Further research would need to be done to determine if these periods of renewal are related to the El Niño cycle.

Tracer experiments (using sulfur hexafluoride) started in the Santa Monica and San Pedro basins (Ledwell and Hickey 1995) in 1985-1986 and in the Santa Cruz Basin (Ledwell and Bratkovich 1995) in 1988-1989, and have yielded addition information on mixing within the interiors the basins in the SCB. The combination of classical oceanographic sampling with new tracer

methods has provided more details on mixing within these basins. In the San Pedro and Santa Monica Basin system, diapycnal mixing (across density surfaces) on at least $1.1 \text{ cm}^2/\text{s}$ is estimated (Ledwell and Hickey 1995), which is four times higher than the original estimate from the tracers at the time of the original experiment (Ledwell and Watson 1991). This suggests that boundary processes play a significant role in mixing within the basin, and would not have been seen in the earlier tracer experiments because of the experimental design. These new values for the enhanced mixing match much better with the results of Berelson (1991) discussed above. Similar experiments in the nearby Santa Cruz Basin (Ledwell and Hickey 1995) more clearly show boundary enhanced mixing. During the early stages of the Santa Cruz experiment, the diapycnal mixing coefficient was estimated at $1.0 \text{ cm}^2/\text{s}$ within a factor of 1.5 as the tracer mixed to the walls. Once the tracer mixed to the walls, spreading increased dramatically, supporting a diapycnal mixing coefficient of $10 \text{ cm}^2/\text{s}$. The significance of boundary mixing is likely related to the larger boundary to interior area in these small basins with mixing in the interior much less significant.

1.7 WAVE CLIMATE

Wave characteristics along the Southern Study Area of the United States depend on weather patterns, geographic affects, storm climatology, coastline orientation and local bathymetry. There are numerous wave monitoring and statistic resources available to the public. The National Data Buoy Center (NDBC, <http://www.ndbc.noaa.gov>) which is run by the National Oceanic and Atmospheric Administration (NOAA) and the Coastal Data Information Program (CDIP, <http://cdips.ucsd.edu>) provide the two largest inventories of archived buoy-recorded wave data. There are approximately 30 NDBC and 80 CDIP stations along the West Coast. Systematic differences between NDBC and CDIP buoy readings show that NDBC buoys read higher wave heights by about 8 percent (Tillotson and Komar 1997).

Most of the CDIP buoys are specifically designed for collecting wave data and are an excellent source for directional wave data. Most do not provide meteorological data. There are a number of products available on the CDIP website including a selection of archived data formats, interactive plots, and coastal wave model outputs. The coastal wave model outputs provide wave energy spectra diagrams along with the predominant wave height and wave period. The swell model is based on wave diffraction-refraction simulations using code developed by Jim Kirby (University of Delaware), Eloi Melo (Santa Catarina Federal University), and Bill O'Reilly (Scripps). An example of the CDIP wave model output is provided below ([Figure 1.20](#)), showing the difference in directional energy spectrum between the warm season and the cool season. Water depth at buoy locations is important when analyzing wave data as wave height and direction for long period swells are affected by bottom bathymetry at water depths of 200 – 300 m or less.

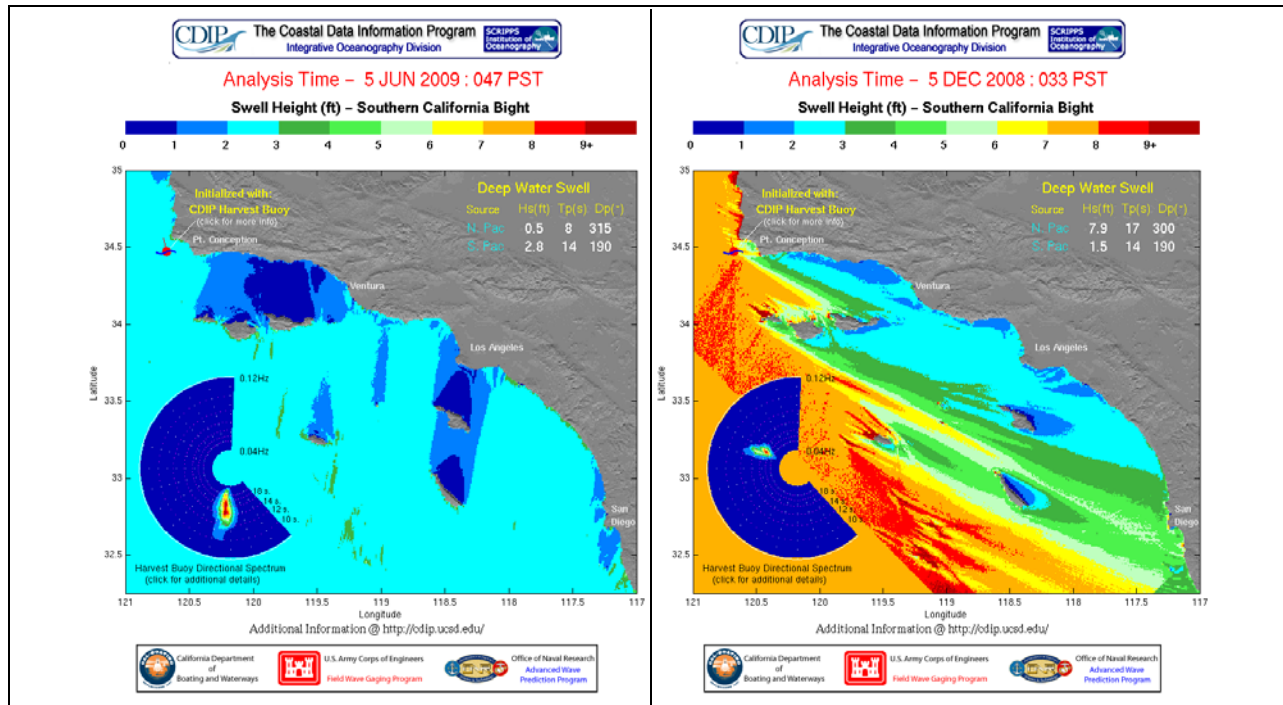

Figure 1.20. CDIP coastal spectral model output got CDIP Station 067 (33 deg 13.33'N, 119 deg 53.00'W NDBC/WMO identifier 46219, approximately 15.5 nmi west of the northwest corner of San Nicholas Island,).

Output shows the difference between summer and winter.

Data from CDIP, Scripps Institution of Oceanography.

NDBC buoys are designed to collect meteorological data along with oceanographic data and are therefore not specifically designed for recording wave data. Only select NDBC buoys collect directional wave data. There are also several satellite-borne altimeter instruments that are used to record wave data. The Topex/Poseidon satellite has been operational since 1992 and the Jason-1 satellite has been operational since 2001. Data from both of these altimeters have been compared to buoy and wave model data (Scott 2005).

There are three wave model outputs that are available to the public: Wave Watch III, CDIP and LOLA. The Wave Watch III (WW III) model outputs are available through the U.S. Navy (<https://www.fnmoc.navy.mil/public>) and NOAA (<http://polar.ncep.noaa.gov>). WW III global and regional wave model outputs provide information on significant wave height, swell wave height, wind wave height, peak wave period, secondary wave period, swell wave period, wind wave period, and whitecap probability. The CDIP coastal wave model is based on wave diffraction-refraction simulations. Real-time and archived CDIP buoy model outputs like those in [Figure 1.20](#) are available on the CDIP website. CDIP is currently developing a wave model prediction database. The LOLA wave model is a coastal wave model that is available on the popular surf website <http://www.surflines.com>. Since the wave energy resource will vary along the coast due to variations in the bathymetry and coastline, and since there are areas where buoy concentrations are low, the use of sophisticated nonlinear wave models (Janssen et al. 2006) may prove to be very useful in wave energy assessment (Largier 2008).

Littoral processes and sediment transport are strongly affected by breaking wave heights and incident wave angles along the shoreline. Typically, waves approaching the coastline from the north will drive an inshore southward current along the West Coast and waves approaching from the south drive an inshore northward current. Depending on how approaching deepwater waves are refracted as they approach shallower waters over the continental shelf and how the coastline blocks waves from certain angles, there can be considerable differences in the transport of material in the littoral zone. There is also evidence that transport in the littoral zone can significantly vary from year to year due to wave climate variances (Figure 1.21) (Allan and Komar 2006). [This is further explained in section 1.7.3.](#)

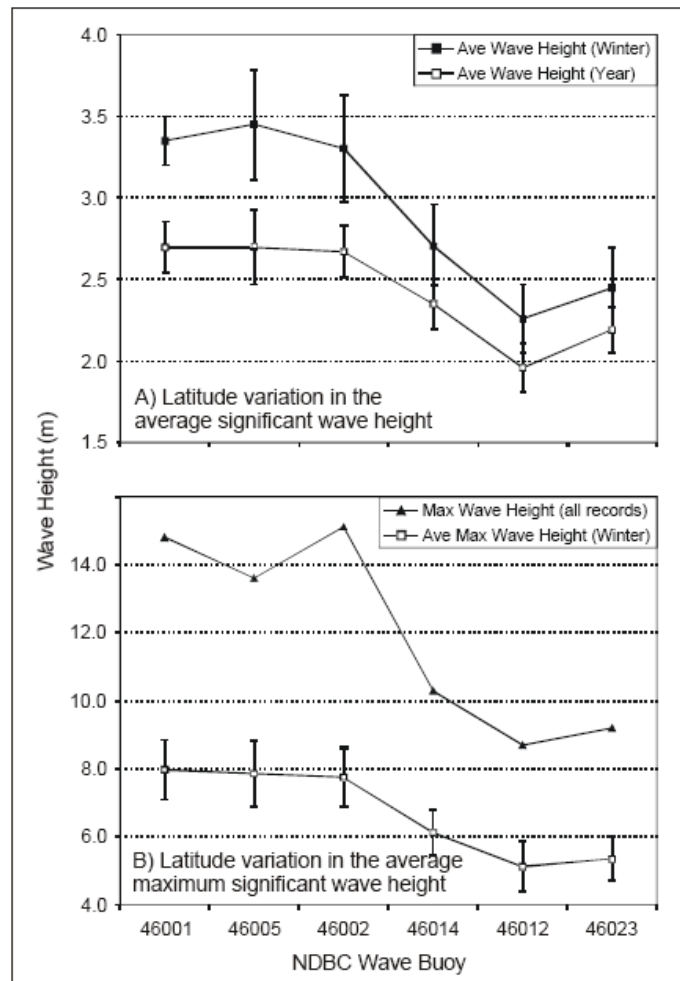

Figure 1.21. Spatial variability of wave heights in the North Pacific: A) Average yearly and winter significant wave heights and B) Average maximum wave heights.

Station 46001 is located in the Gulf of Alaska, while station 46023 is located of Point Arguello.

From Allan and Komar (2000).

The latitudinal distribution of wave energy decreases from Northern California to Southern California (Behrens et al. 2008). Wave energy is lowest in the Southern California Bight because of the change in shoreline orientation at Point Conception. For example at Point Conception, waves greater than four meters occur 11 percent of the time (Behrens et al. 2008). The USGS National Assessment of Shoreline Change (Hapke et al. 2006) summarizes wave characteristics along the California Coast. The Channel Islands and Point Conception effectively block incoming waves. Wave heights peak from November to February, averaging about 2.4 m. Summer wave heights are smaller, 1.8 m in the mean. Overall wave intensity (annual overall median wave height) has decreased since the mid-1970s, though events with large waves have increased and are correlated with El Niño Events (Seymour 1996). During an El Niño, wave heights average 0.7 m higher (Seymour 1998) because of increased storm activity. The relatively shallow bathymetry of the Southern California Bight refracts incoming waves, creating complex wave patterns.

1.7.1 Directional Energy Spectrum

The offshore wave climate along the Southern Study Area can be characterized by four regimes: Northern Pacific swell, Southern hemisphere swell, northwest wind swell, and locally generated waves (Hapke et al. 2006). The influence of the coastline and wave direction can be seen in Figure 1.20 (showing the influence of North Pacific Swell in winter and Southern Swell in summer), and in [Figure 1.22](#). As mentioned above [in section 1.2.1.1](#), topography shields the Southern California Bight significantly from northwest winds swell. Directional differences of significant wave height between inshore and offshore locations in the SCB can also be seen in [Figure 1.22](#). The interior of the SCB is effectively in a wave shadow once inside the islands. Since the winds off the northwest coast of the United States and Pacific Ocean are seasonally variable, so are wind-driven sea-surface gravity waves. In general, during the winter a large percentage of wave energy that reaches the coast is from powerful storms that develop in the more northern areas of the North Pacific. These storm driven swells arrive at the coast with relatively large wave amplitudes and long wave periods. During the spring the storms become less frequent and a large percentage of wave energy is derived locally by strong winds along the coast. These locally wind-driven waves have relatively smaller amplitudes and shorter time periods. During the late summer and early fall storms in the North Pacific and winds along the coast are not as frequent or as strong. Therefore, there is less wave energy reaching the coast during this time of year. Between spring and fall occasionally significant swells reach the coast from storms in the South Pacific. Seasonal variability is explained in further detail in [section 1.7.2 below](#).

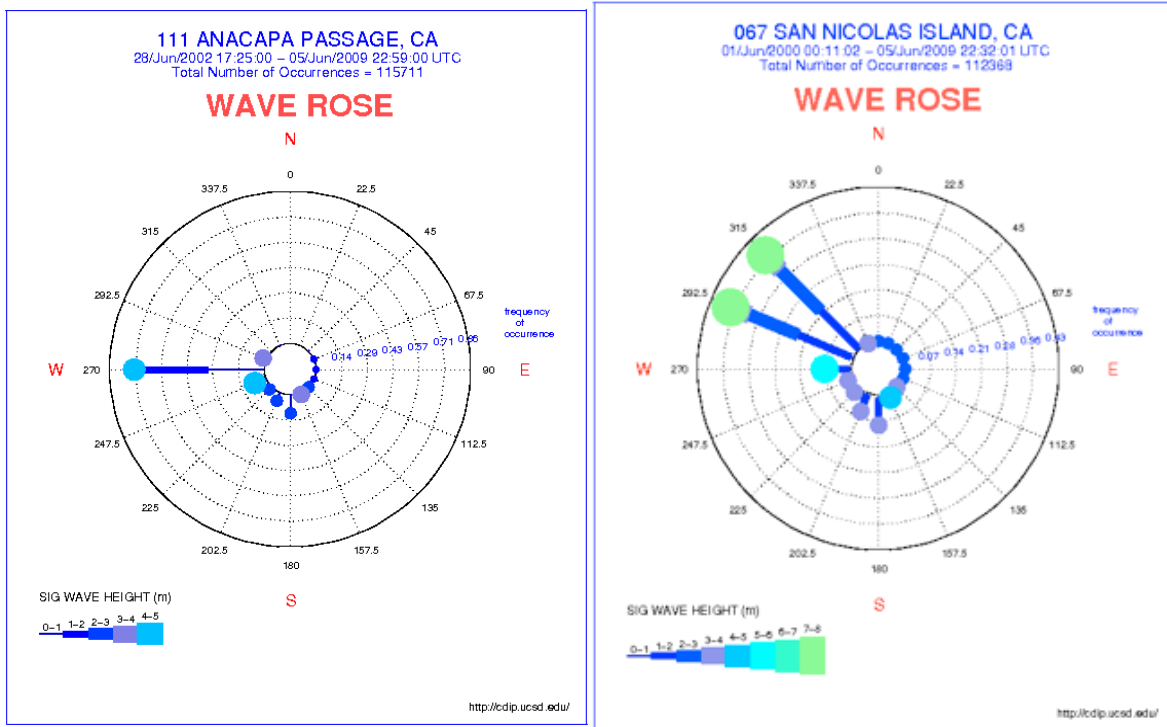

Figure 1.22. Significant wave height wave rose for CDIP buoy 067 (33 deg 13.33'N, 119 deg 53.00'W NDBC/WMO identifier 46219, approximately 15.5 nmi west of the northwest corner of San Nicholas Island,) and CDIP buoy 111 (34 deg 10.21'N, 119 deg 26.15'W, NDBC/WMO Identifier 46217, Anacapa Passage.

The effect of topography sheltering the SCB from southwestward winds and the coastline turn at Point Conception sheltering from southwestward swell is seen between the two graphs. The more open water buoy is on the left, and the more shoreward buoy is on the right.

Data from CDIP, Scripps Institution of Oceanography

Statistics for the Southern California Bight ([Table 1.1 below](#)) from Beyene and Wilson (Beyene and Wilson 2006) show an average significant wave height in winter over 2 m, with significant periods of 3-7 m wave heights, while in summer the average significant wave height is less than 1.5 m. The annual average for significant wave height is 1.72 m with variation approximately ± 0.5 m. In winter the dominant swell has a wave period of 11.01s from the west, while the summer swell is from the west/northwest, combined with significant locally-generated wind waves. In [Figure 1.22](#) the two significant wave height roses show how in the open water (left), the waves come from the West Northwest, while in the shelter of the Bight close to shore, waves are from the west and relatively lower. The wave shadows formed by the change in coastline direction and the Channel Islands ([shown in Figure 1.20](#)) effectively filter out the largest waves. The average power density is 35.09 kW/m based on the Point Conception NDBC buoy 460063 (34.25 deg N, 120.66 deg W) (Beyene and Wilson 2006). Southern California has less total available energy, as also suggested by [Figure 1.22](#), but this energy is more predictable (Behrens et al. 2008) (Table 1.2).

Table 1.1.

Wave height and period scatter table for the Southern California Bight. From Beyene and Wilson 2006

h_s (m)	T_p (s)											Total
	0-2	2-4	4-6	6-8	8-10	10-12	12-14	14-16	16-18	18-20	20+	
0.0-0.5	1	0	0	0	0	0	0	0	0	0	0	1
0.5-1.0	0	0	0	1	3	1	3	3	2	0	0	13
1.0-1.5	0	1	13	7	41	14	16	27	22	4	0	144
1.5-2.0	0	0	20	26	55	28	32	34	42	7	0	244
2.0-2.5	0	0	4	46	50	25	36	34	24	9	1	230
2.5-3.0	0	0	0	21	33	13	25	34	18	8	0	154
3.0-3.5	0	0	0	4	21	7	16	28	14	5	0	95
3.5-4.0	0	0	0	1	11	4	7	18	11	3	0	55
4.0-4.5	0	0	0	0	3	3	4	10	9	2	0	32
4.5-5.0	0	0	0	0	2	2	3	4	6	1	0	17
5.0-5.5	0	0	0	0	0	1	1	2	3	1	0	8
5.5-7.0	0	0	0	0	0	0	1	1	3	1	0	6
7.0-9.0	0	0	0	0	0	0	0	0	0	0	0	0
9.0-11.0	0	0	0	0	0	0	0	0	0	0	0	0
Total	1	1	38	106	220	98	144	196	154	40	2	1000

Table 1.2.

Predictability of wave heights by location. Wave heights can be used as a proxy for wave energy. The Southern California Bight shows much less variance both for particular months and over the annual cycle compared to Bodega Bay, Santa Marine and Hawaii.

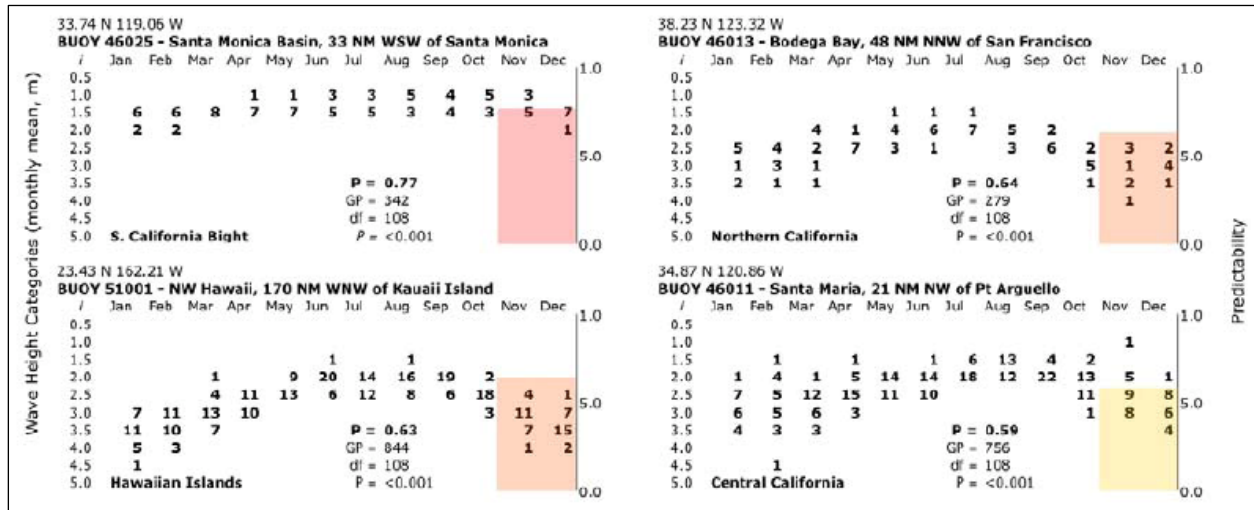

From (Behrens et al. 2008).

1.7.2 Variability Timescales

Since winds generate surface gravity waves, any variability in the meteorology, either local or far offshore, will cause variability in the wave climate. There are four easily identifiable wave

energy variability timescales reaching the West Coast: Diurnal, storm duration, seasonal, and annual/decadal. In addition, this section reports on the increase in storm-generated waves heights that have been observed on the open U.S. West Coast from the Northern Study Area to the Southern Study area over the last three decades.

As described in [section 1.2.1](#) Winds, there is a diurnal variability in both long-shore and cross-shore winds over the inner continental shelf due to local sea-breeze effects. Diurnal winds are short-lived and have a relatively limited fetch. Therefore, they do not generate a large amount of wave energy and the waves usually have small amplitudes and short periods.

The coastal wave environment can be quite different between storm-generated waves far offshore over the North (or South) Pacific Ocean and storm-generated waves directly offshore. Midlatitude North and South Pacific storms generally traverse westward as they follow the upper atmosphere jet stream, can last from a day to over a week and generate waves along the way. Since the swell from storms generated from far offshore travel thousands of kilometers, the faster-moving long-period waves separate out from slower-moving short-period waves and arrive at the coast first. In contrast to storms generated far offshore over the Pacific Ocean, storms that are directly offshore generate swells with wave periods that do not separate out. When these raw swells reach the coast, the waves are multidirectional, large amplitude (depending on the strength of the storm), and have a wide range of periods. These swells typically last only a day or two but can last longer.

There is a seasonal trend in wave heights ([Figure 1.22](#) from (Allan and Komar 2000), see also [Figures 1.18](#) and [Table 1.2](#)). As summarized in [section 1.7.1](#), statistics for the Southern California Bight ([Figure 1.23 below](#)) from Beyene and Wilson (2006) show an average significant wave height in winter over 2 m, with significant periods of 3-7 m wave heights, while in summer the average significant wave height is less than 1.5 m. The annual average for significant wave height is 1.72 m with variation approximately ± 0.5 m. In winter the dominant swell has a wave period of 11.01s from the west, while in summer swell is from the west/northwest combined with significant locally generated winds waves.

Allan and Komar (2000) show a long-term trend of increasing annual average significant wave heights and annual average winter (October through January) wave heights ([Figure 1.24](#)), which they also relate to longer term climate trends for the West Coast. However, Southern California shows no statistically significant trends. Instead the Southern California waves show a minimum in about 1990 of monthly significant wave heights of about 1 m compared with waves in the early 1980s and 1990s.

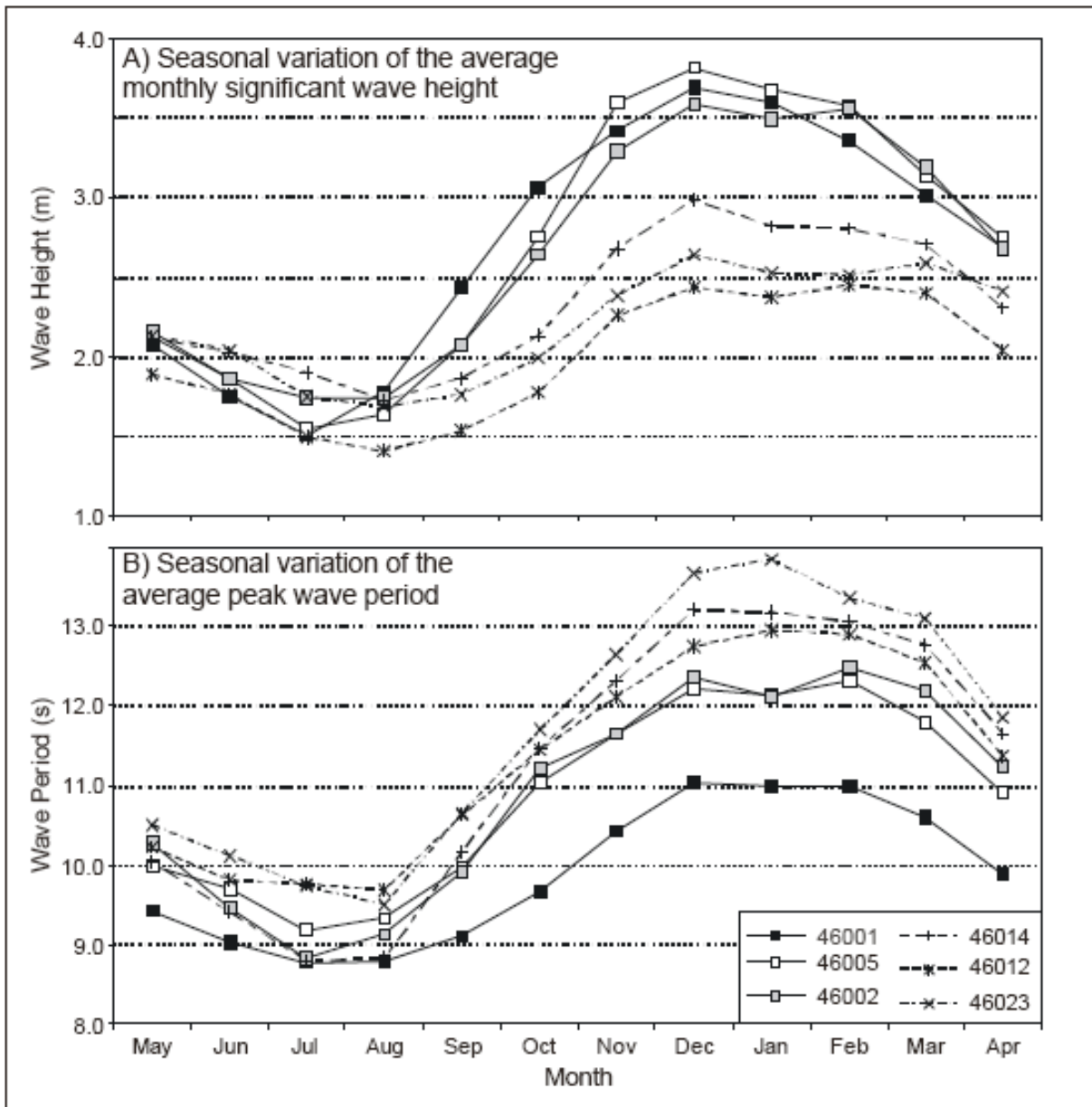

Figure 1.23. Seasonal variability of wave climate in the North Pacific.

A) Mean monthly significant wave height and B) Mean monthly peak wave period.

From Allan and Komar (2000).

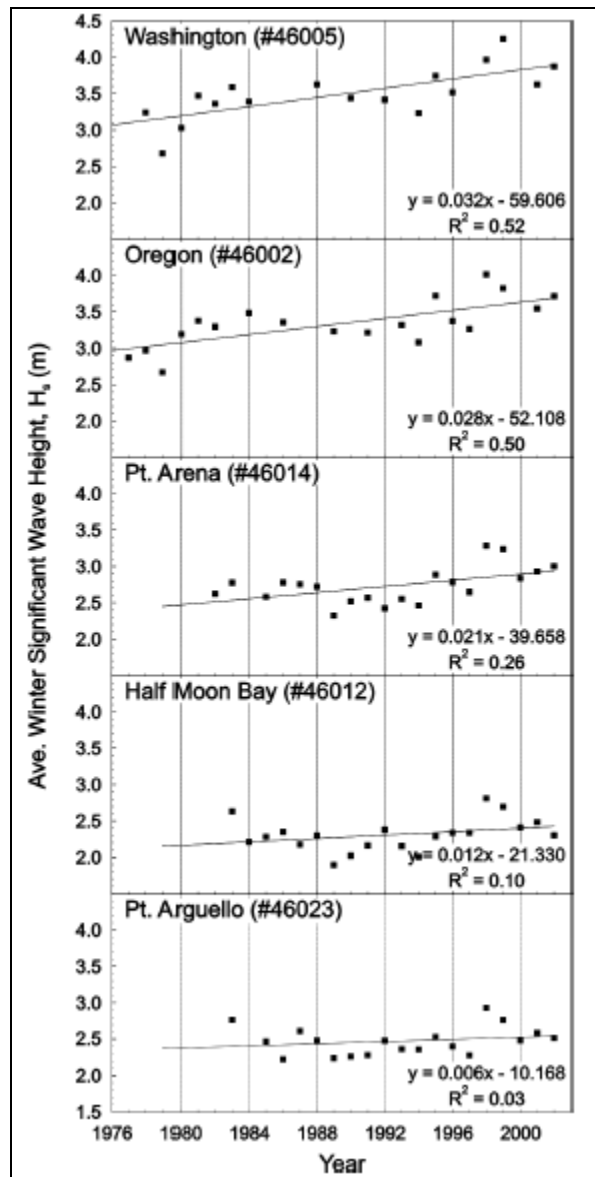

Figure 1.24. Decadal trends in annual averages of the winter significant wave heights measured by West Coast buoys at different latitudes.

From (Allan and Komar 2006).

1.7.3 Connection with Littoral Processes and Sediment Transport

Along most of the Northern and Southern Study Areas, wave dynamics are the primary mechanism that adjusts the shoreline. Breaking waves provide the most important energy input in nearshore waters and are responsible for the generation of nearshore currents, high levels of turbulence, and the transport of sediments. These processes control the morphology of beaches, as well as sand barriers and spits at the mouths of estuaries (Largier 2008).

Waves have a large impact on the shape and profile of beaches. The beach profile is important as a natural mechanism that causes waves to break and dissipate their energy. Increased wave

energy causes the beach to respond by reducing its overall slope and shifting the breaker zone farther offshore. The ability of a beach to adjust to prevailing forces acts as an effective method of coastal defense (Largier 2008). The effect of waves on beaches can be put into two simplified cases: “destructive” during storm events and “constructive” during calm events (Dean and Dalrymple 2002). Storm driven destructive forces erode the beach and develop an offshore sand bar, whereas constructive forces act to move the sand bar closer to shore and steepen the beach profile. The gradually sloping beach with an offshore sand bar is often referred to as the winter profile and the wide beach with a steep profile on the shoreline is often referred to as the summer profile. The variance of wave heights throughout the year typically causes a long-term balance in the amount of sediment supplied to and taken from a beach.

Wave properties change as they interact with shallower waters near the shore. As the propagation speed of waves decreases over shallow water and becomes a function of water depth, the period remains the same, the wavelengths decrease, and the wave heights and steepness increase. This process is called shoaling. In addition, waves traveling over varying degrees of shallowness cause them to refract toward shallower water. This leads to wave focusing on headlands and bars and wave dissipation in deep embayment and channels. The height of nearshore waves is a function of the deepwater wave height, the degree of refraction, and the degree of shoaling. As a wave approaches the shore, its steepness generally increases up to the point where it becomes unstable and break. Theoretical studies of waves in constant-depth water showed that a wave breaks when its height exceeds approximately 80 percent of the water depth. Once a wave breaks, the release of energy varies depending on the wave’s initial characteristics and the shape of the shoreline. If the shore angle is steep, the wave will reflect, which leads to offshore sand bar development and the creation of cusps.

There are four distinct hydrodynamic forces due to breaking waves acting on objects in the surf zone (Largier 2008): (1) drag, (2) lift, (3) acceleration, and (4) impingement. These four hydrodynamic forces are calculated using the velocity in the surf zone (details and formulas can be found in (Largier 2008)). Velocity in the surf zone depends directly on wave height according to the relationship:

$$u_{sz} \cong 0.6\sqrt{gH_{\max}}$$

where u_{sz} is the water velocity at the substrate in the surf zone, and H_{\max} is the maximum wave height (Denny 2006). From this relationship, a 15 percent reduction in wave height results in a 7.8 percent reduction in velocity. The hydrodynamic forces (drag, lift, acceleration, and impingement) are linearly dependent on wave height such that a 7.8 percent reduction in water velocity would correspond to a 15 percent reduction in each of the four hydrodynamic forces.

Three important characteristics of nearshore impacts of wave energy are turbulence, wave runup, and wave “setup.” Waves create turbulence, a property of water motion that involves chaotic water movement on multiple scales, resulting in small-scale, nonlinear flow. Turbulence is increased by the presence of obstacles in the flow, roughness of the surface over which water is flowing, and by water velocity. Turbulent flow is particularly important for the transport of small particles, including nutrients and sediment. Wave runup is the maximum vertical extent of wave up-rush on a beach or shoreline. The runup height is dependent on wave energy, beach

slope, and beach roughness and sill-water modulations due to tides, winds and runoff to the ocean. Wave “setup” is the buildup of water along the shore due to wave-driven currents (Largier 2008).

Nearshore currents are primarily due to wave radiation stresses and alongshore differences in wave setup. Waves drive along-shore currents and rip currents that transport water offshore. Undertow and rip currents are important for the transport of larval organisms away from the shore during the early stages of development. Wave-driven along-shore currents are generated by a combination of obliquely breaking waves and long-shore variations in wave “setup.” Longshore currents are related to breaker height and incident angle.

1.8 SUMMARY AND DATA GAPS

The Southern Study Area contains both the southern end of the large West Coast upwelling region that ends at Point Conception, and the relatively sheltered Southern California Bight. The geometry of the coastline and topography create a definitive break between the circulation inshore of a line running approximately between Point Conception and Ensenada, Mexico. Inside this line, winds are weak, while offshore of this line the wind speeds are comparable in magnitude to those found over the continental shelf north of Point Conception. Winds and currents have a distinct seasonal cycle, and scientists are learning more about the shorter-term variations, such as short-term coastally trapped wind reversals, and longer-term cycles that are influenced by the larger Pacific Ocean setting. Predictions of the circulation of currents in the Southern Study Area work well in the mean, but sudden shifts or reversals in winds and currents can be challenging if not impossible to predict. Data related to understanding the longer time-scales dynamics requires longer-term CalCOFI observations and similar types of observations that include sea surface elevation further north within the U.S. and/or Canada, and further south in cooperation with Mexico. This information would provide information to understand and potentially forecast current transitions. For shorter time-scale understanding of the details of how current transitions occur, further observations such as Lynn et al. (2003) would be needed. Improving buoy information available in the open North Pacific in cooperations with the NOAA NWS could improve weather and wind prediction along the West Coast, particularly for storm events. Improved predictions of the current transitions, wind events and circulation details within the SCB would aid in predictions of dependent biological systems and potential trajectories of any oil spills.

Ocean temperature and salinity in the Eastern Pacific are determined by three source water masses and air-sea energy exchange. North Pacific Subarctic Water, North Pacific Central Water and North Pacific Equatorial water are all present in the SCB. Subtidal temperature changes are correlated with the large scale along-shore pressure gradient while upper ocean CalCOFI temperature trends are correlated with PDO. Salinity, though not correlated with the PDO, is correlated with the NPGO. The latter correlation suggests that sea surface temperature may be locally forced (wind, heat flux), while salinity more remotely. Longer series measurements along the coast, as discussed above, would provide information on differentiating El Niño, PDO, NPGO, effects related to water column properties.

Upwelling favorable winds have increased, particularly during the warm season (April – September). The cool season winds are variable due to low pressure systems moving through the area. As these low pressure systems pass by, strong southeasterly winds precede the low, followed then by northwesterly winds. Though the upwelling favorable winds have increased, so have surface temperatures, leading to increased stratification, which inhibits upwelling. Higher upwelling indices are seen further north than the SCB in the CalCOFI data, but nutrients and zooplankton concentration are decreasing in the SCB, which suggests less upwelling than in previous decades. Continuing time series observations that include the water column could confirm these changes in the CC system overall.

The Santa Monica Basin and Santa Barbara Channel can both be described by three different patterns: Upwelling, Surface Convergent and Relaxation. The Upwelling Pattern generally occurs during the early part of the warm season, after the spring transition. The Surface Convergent Pattern is most prevalent in summer. The Relaxation Pattern is typical of late fall and early winter. The Santa Monica Bay has a mean circulation on the warm season of two counter-rotating gyres, with the mean surface velocities flowing in to the bay.

The deep basins of the SCB generally renew water during seasonal flushing that moves from the offshore basins to the more inshore ones. Long-term oxygen concentration and mixing trends in some deep basins indicate periods of water stagnation punctuated by periods of water renewal. Further research would need to be done to determine if these periods are related to the El Niño cycle. When looked at in detail, the time between larger renewal events is punctuated by smaller events. Tracer experiments show how mixing is much higher near the basin walls than in the basin interior.

Wave energy is lowest in the Southern California Bight compared to the rest of the continental U.S. West Coast, because of the change in shoreline orientation at Point Conception. The relatively shallow bathymetry of the Southern California Bight refracts incoming waves, creating complex wave patterns. Overall wave intensity (annual overall median wave height) has decreased since the mid-1970s, though events with large waves have increased and are correlated with El Niño Events.

Wave statistics for the Southern California Bight show an average significant wave height in winter over 2 m, with significant periods of 3-7 m wave heights, while in summer the average significant wave height is less than 1.5 m. The annual average for significant wave height is 1.72 m with variation approximately ± 0.5 m. In winter the dominant swell has a wave period of 11.01s from the west, while the summer swell is from the west/northwest combined with significant locally generated winds waves. In the open water, the waves come from the West Northwest, while in the shelter of the Bight closer to shore, waves are from the west and relatively lower. The wave shadows formed by the change in coastline direction and the Channel Islands effectively filter out the largest waves. The average power density is 35.09 kW/m based on the Point Conception NDBC buoy 460063 (34.25°N, 120.66°W). Southern California has less total available wave energy, but this energy is more predictable. While other areas of the West Coast show a long-term trend of increasing annual average significant wave height since 1981,

Southern California shows a minimum in about 1990, and no statistically significant evidence of any increase since.

1.9 LIST OF LITERATURE CITED—PHYSICAL OCEANOGRAPHY

Allan, J.C. and P.D. Komar. 2000. Spatial and temporal variations in the wave climate of the North Pacific. Oregon Dept. of Land Conservation and Development.

Allan, J.C. and P.D. Komar. 2006. Climate controls on the U.S. West Coast erosion process. *Journal of Coastal Research* 22(3):511-529.

Auad, G, Myrl C. Hendershott, and C.D. Winant. 1997. The low frequency transport in the Santa Barbara Channel: Estimation, description and forcing. In *Oceanography* 43:111-155.

Bane, J., M. Levine, R. Samelson, S. Haines, M. Meaux, N. Perlin, P. Kosro and T. Boyd. 2005. Atmospheric forcing of the Oregon coastal ocean during the 2001 upwelling season. *Journal of Geophysical Research* 110: C10S02, doi:10.1029/2004JC002653.

Behrens, D., J. Castle, G. Crawford, R.N. Gaddam, S.C. Hackett, J. Largier, D.P. Lohse, K.L. Mills, P.A. Nelson, P.T. Raimondi, M. Robart, W.J. Sydeman, S.A. Thompson and S. Woo. 2008. Developing wave energy in Coastal California: Potential socio-economic and environmental effects. Prepared for: California Energy Commission.

Berelson, W.M. 1991. The flushing of two deep-sea basins, Southern California Borderland. *Limnology and Oceanography* 36(6):1150-1166.

Beyene, A. and J.H. Wilson. 2006. Comparison of wave energy flux for northern, central, and southern coast of California based on long-term statistical wave data. *Energy* 31:1856-1869.

Boehm, A.B., Lluch, D.B. Cota, K.A. Davis, C.D. Winant and S.G. Monismith. 2004. Covariation of coastal water temperature and microbial pollution at interannual to tidal periods. *Geophys. Res. Lett.* 31(6):1-5.

Bograd, S.J. and R.J. Lynn. 2003. Long-term variability in the Southern California Current System: Annual cycle and inter annual variability. *Journal of Geophysical Research* 98B:18119-18145.

Bray, N. and C.L. Greengrove. 1993. Circulation over the shelf and slope off Northern California. *Journal of Geophysical Research* 98(C10):18119-18145.

Bray, N.A., A. Keyes and W.M.L. Morawitz. 1999. The California Current System in the Southern California Bight and the Santa Barbara Channel. *Journal of Geophysical Research* 104(C4):7695-7714.

CalCOFI. 2008. Physical, Chemical and Biological Data: CalCOFI Cruise 0707. CC Reference 08-07.

- Caldeira, R.M., and P Marchesiello. 2002. Ocean response to wind sheltering in the Southern California Bight. *Geophysical Research Letters* 29, doi:10.1029/2001GL014563.
- Chao, Y., M. Ghil, and J.C. McWilliams. 2000. Pacific interdecadal variability in this century's sea surface temperatures. *Geophysical Research Letters* 27:2251-2264.
- Cheriskin, T.K. and M. Trunnell. 1996. Correlation scales, objective mapping, and absolute geostrophic flow in the California Current. *Journal of Geophysical Research-Oceans* 101(C10):22619-22629.
- Cudaback, C.N., L. Washburn, and E. Dever. 2005. Subtidal inner-shelf circulation near Point Conception, California. *J. Geophys. Res.* 110(C10):1-12.
- Dean, R.G. and R.A. Dalrymple. 2002. Coastal processes with engineering applications. Cambridge Press, Cambridge, MA.
- Denny, M.W. 2006. Ocean waves, nearshore ecology, and natural selection. *Aquatic Ecology* 40(4):439-461.
- Dever, E., M. Hendershott, and C. Winant. 1998a. Statistical aspects of surface drifter observations of circulation in the Santa Barbara Channel. *J. Geophys. Res.* 103(C11):24781-24797.
- Dever, E.P., M.C. Hendershott, and C.D. Winant. 1998b. Statistical aspects of surface drifter observations of circulation in the Santa Barbara Channel. *Journal of Geophysical Research* 103(24,781-24,797).
- Dever, E.P. 2004. Objective maps of near-surface flow states near Point Conception, California. *Journal of Physical Oceanography* 34:444-461.
- Di Lorenzo, E. 2008. North Pacific Gyre Oscillation. Internet website: <http://www.o3d.org/npgo/>. Accessed July 17, 2009.
- Di Lorenzo, E. 2003a. Seasonal dynamics of the surface circulation in the Southern California Current System. *Deep-Sea Research Part II* 50(14-16):2371-2388.
- Di Lorenzo, E. 2003b. Dynamics of the Southern California Current System. University of California, San Diego. Pp.110.
- Di Lorenzo, E., A. Miller, N. Schneider and J.C. McWilliams. 2005. The warming of the California Current System: Dynamics and ecosystem implications. *Journal of Physical Oceanography* 35:336-362.
- Di Lorenzo, E., N. Schneider, K.M. Cobb, P.J.S. Franks, K. Chhak, A.J. Miller, J.C. McWilliams, S.J. Bograd, H. Arango, E. Curchitser, T.M. Powell and P. Riviere. 2008. North Pacific Gyre Oscillation links ocean climate and ecosystem change. *Geophysical Research Letters*, 35(L08607):1-6.

- Dorman, C. and C. Winant. 1995. Buoy observations of the atmosphere along the West Coast of the United States, 1981-1990. *J. Geophys. Res.* 100(C8):16029-16044.
- Dorman, C.E. and C.D. Winant. 2000. The structure and variability of the marine atmosphere around the Santa Barbara Channel. *Monthly Weather Review* 128(2):261-282.
- Funes-Rodriguez, R., A. Hinojosa-Medina, G. Aceves-Medina, S.P.A. Jimenez-Rosenberg and J. Bautista-Romero. 2006. Influences of El Niño on assemblages of mesopelagic fish larvae along the Pacific Coast of Baja California Sur. *Fisheries Oceanography* 15:244-255.
- Hapke, C.J., D. Reid, B.M. Richmond, P. Ruggiero and J. List. 2006. National assessment of shoreline change Part 3: Historical shoreline change and associated land loss along sandy shorelines along the California Coast. U.S. Geological Survey 2006-1219.
- Harms, S. 1996. Circulation Induced by Winds and Pressure Gradients in the Santa Barbara Channel. Doctoral dissertation, University of Southern California. . 161 pp.
- Harms, S. 1998. Propagating eddies in the Santa Barbara Channel. In Magoon, Orville T. California and the World Ocean '97: Taking a look at California's Ocean Resources: An agenda for the future. Conference Proceedings Volume 2:1528-1534.
- Harms, S. and C. Winant. 1998. Characteristic patterns of the circulation in the Santa Barbara Channel. *J. Geophys. Res.* 103(C2):3041-3065.
- Hickey, B.M. 1993. Circulation and particle fluxes in the Southern California Bight. Final report Grant No. DE-FG05-85-ER60333. Available at <http://www.osti.gov/bridge/purl.cover.jsp;jsessionid=139AF4E220D9B8332F8FD193CE6CD5D1?purl=/759196-nRq5yB/webviewable/>.
- Hickey, B.M., E.L. Dobbins and S.E. Allen. 2003. Local and remote forcing of currents and temperature in the central Southern California Bight. *Journal of Geophysical Research* 108(C3). 3081, doi:10.1029/2000JC000313.
- Hsieh, C., H.J. Kim, W. Watson, E. Di Lorenzo and G. Sugihara. 2009. Climate-driven changes in abundance and distribution of larvae of oceanic fishes in the Southern California region. *Global Change Biology*, doi:10.1111/j.1365-2486.2009.01875.x.
- Janssen, T.T., H.C. Herbers and J.A. Battjes. 2006. Generalized evolution equations for nonlinear surface gravity waves over two-dimensional topography of *Fluid Mechanics* 552:393-418.
- Kalnay, E., M. Kanamitsu, R. Kistler, W. Collins, D. Deaven, L. Gandin, M. Iredell, S. Saha, G. White, J. Woolen, Y. Zhu, A. Leetmaa, R. Reynolds, M. Chelliah, W. Ebisuzake, W. Higgins, J. Janowiak, K.C. Mo, C. Ropelewski, J. Wang, R. Jenne and D. Joseph. 1996. The NCEP/NCAR 40-year reanalysis project. *Bulletin of the American Meteorological Society* 77:437-471.

- Largier, J. 2008. The potential impact of WEC development on nearshore and shoreline environments through a reduction in nearshore wave energy. In: *Developing wave energy in Coastal California: Potential socio-economic and environmental effects*. California Energy Commission, PIER Energy-Related Environmental Research Program and California Ocean Protection Council.
- Ledwell, J. and B. Hickey. 1995. Evidence for enhanced boundary mixing in the Santa Monica Basin. *J. Geophys. Res.* 100(C10):20665-20679.
- Ledwell, J.R. and A. Bratkovich. 1995. A tracer study of mixing in the Santa Cruz Basin. *Journal of Geophysical Research* 100(C10):20681-20704.
- Ledwell, J.R. and A.J. Watson. 1991. The Santa Monica Basin tracer experiment: A study of diapycnal and isopycnal mixing. *Journal of Geophysical Research* 96:8695-8718.
- Lerczak, J.A. 2000. *Internal waves on the Southern California Shelf*. University of California, San Diego. 244 pp.
- Lerczak, J.A., M.C. Hendershott, and C.D. Winant. 2001a. Coherence between the semidiurnal barotropic tide and internal tidal currents on the Southern California shelf and slope. *J. Phys. Oceanography*. Manuscript submitted June 2001.
- Lerczak, J., M. Hendershott and C. Winant. 2001b. Observations and modeling of coastal internal waves driven by a diurnal sea breeze. *J. Geophys. Res.* 106(C9):19715-19729.
- Lerczak, J.A., C.D. Winant and M.C. Hendershott. 2003. Observations of the semidiurnal internal tide on the Southern California slope and shelf. *J. Geophys. Res.* 108(C3):1311-1313.
- Levitus, S. and T.P. Boyer. 1994. *World Ocean Atlas. 1994. Volume 4: Temperature*. NOAA atlas NESDIS 4, U.S. Dept. of Commerce, Washington, DC. 117 pp.
- Levitus, S., R. Burgett, and T.P. Boyer. 1994. *World Ocean Atlas 1994 Volume 3: Salinity*. NOAA atlas NESDID 3, U.S. Dept. of Commerce, Washington, DC. 99 pp.
- Lluch-Cota, D.B., W.S. Wooster and S.R. Hare. 2001. Sea surface temperature variability in coastal areas of the northeastern Pacific related to the El Niño-southern oscillation and the Pacific decadal oscillation. *Geophysical Research Letters* 28:2029-2032.
- Luther, D.S. and C. Wunsch. 1975. Tidal charts of the Central Pacific Ocean. *Journal of Physical Oceanography* 5:222-230.
- Lynn, R.J., S.J. Bograd, T.K. Chereskin and A. Huyer. 2003. Seasonal renewal of the California Current: The spring transition off California. *Journal of Geophysical Research* 108(C8), 3279, doi:10.1029/2003JC001787.

- Maccall, A., D. 1996. Patterns of low frequency variability in fish populations of the California Current. 100-110 pp.
- Mantua, N.J. and S.R. Hare. 2002. The Pacific decadal oscillation. *Journal of Oceanography* 58(1):35-44.
- Mantua, N.J., S.R. Hare, Y. Zhang, J.M. Wallace and R.C. Francis. 1997. A Pacific interdecadal climate oscillation with impacts on salmon production. *Bulletin of the American Meteorological Society* 78:1069-1079.
- Mass, C.F. and N.A. Bond. 1996. Coastally trapped wind reversals along the United States West Coast during the warm season. Part II. Synoptic Evolution. *Monthly Weather Review* 124(3):446-461.
- McGowan, J., S.J. Bograd, R.J. Lynn and A. Miller. 2003. The biological response to the 1977 regime shift in the California Current. *Deep-Sea Research* 50:2567-2582.
- Meyers, S.D., A. Melsom, G.T. Mitchum and J.J. O'Brien. 1998. Detection of the fast Kelvin wave teleconnection due to El Niño southern oscillation. *Journal of Geophysical Research-Oceans* 103(C12):27655-27663.
- Neelin, J.D., D.S. Battisti, A.C. Hirst, F.-F. Jin, Y. Wakata, T. Yamagata and S.E. Zebiak. 1998. ENSO Theory. *Journal of Geophysical Research* 103(C7):14261-14290.
- Oey, L.Y. 1999. A forcing mechanism for the poleward flow off the Southern California coast. *Journal of Geophysical Research-Oceans* 104(C6):13529-13539.
- Oey, L.Y., D.P. Wang, T. Hayward, C. Winant and M. Hendershott. 2001. "Upwelling" and "cyclonic" regimes of the near-surface circulation in the Santa Barbara Channel. *J. Geophys. Res.* 106(C5):9213-9222.
- Oey, L.Y., C. Winant, E. Dever, W. R. Johnson and D.P. Wang. 2004. A model of the near-surface circulation of the Santa Barbara Channel: Comparison with observations and dynamical interpretations. *Journal of Physical Oceanography* 34(1):23-43.
- Peterson, B., R. Emmett, R. Goericke, E. Venrick, A. Mantyla, S.J. Bograd, F.B. Schwing, S. Ralston, K.A. Forney, R. Hewitt, N. Lo, W. Watson, J. Barlow, M. Lowry, B.E. Lavaniegos, F. Chavez, W.J. Sydeman, D. Hyrenbach, R.W. Bradley, P. Warzybok, K. Hunter, S. Benson, M. Weise and J. Harvey. 2006. The state of the California Current, 2005-2006: Warm in the North, cool in the South. *California Cooperative Oceanic Fisheries Investigations Reports* 47:30-74.
- Redmond, K.T. and R.W. Koch. 1991. Surface climate and streamflow variability in the western United States and thier relationship to large scale circulation indexes. *Water Resources Research* 27(9):2381-2399.

- Roemmich, D. and J. McGowan. 1995a. Sampline zooplankton: correction. *Science* 268:352-353.
- Roemmich, D. and J. McGowan. 1995b. Climatic warming and the decline of the zooplankton in the California Current. *Science* 267(1324-1326).
- Rykaczewski, R.R. and D.M. Checkley. 2008. Influence of ocean winds on pelagic ecosystem in upwelling regions. *Proceedings of the National Academy of Science* 105(6):1965-1970.
- Schneider, N.E., E. Di Lorenzo and P. Niiler. 2005. Salinity variations in the Southern California Current. *Journal of Physical Oceanography* 35:1421-1436.
- Schwing, F.B., S.J. Bograd, C.A. Collins, G. Gaxiola-Castro, J. Garcia, R. Goericke, J. Gomez-Valdez, A. Huyer, K.D. Hyrenbach and P.M. Kosro. 2002. The state of the California Current, 2001-2002: Will the California Current System keep its cool, or is El Niño looming? CalCOFI Rep. 43.
- Schwing, F.B. and R. Mendelssohn. 1997a. Increased coastal upwelling in the California Current System. *Journal of Geophysical Research* 102B:3421-3438.
- Schwing, F.B. and R. Mendelsohn. 1997b. Correction to “Increased coastal upwelling in the California Current system.” *Journal of Geophysical Research* 102(C6):12785-12786.
- Scott, D. 2005. Pacific Ocean wave information study validation of wave model results against satellite altimeter data. Draft Report, W.F. Baird and Associates, September 25, 2005.
- Seymour, R. 1996. Wave climate variability in Southern California. *Journal of Waterway, Port, Coastal and Ocean Engineering* 122(4):182-186.
- Seymour, R.J. 1998. Effects of El Niño on the West Coast wave climate. *Shore and Beach* 66(3):3-6.
- Shinker, J.J. and P.J. Bartlein. 2009. Visualizing the large-scale patterns of ENSO-related climate anomalies in North America. *Earth Interactions* 13:1-50.
- Strub, P.T., J.S. Allen, A. Huyer, R.L. Smith and R. Beardsley. 1987. Seasonal cycles of currents, temperatures, winds, and sea level over the northeast Pacific continental shelf. *J. Geophys. Res* 92(C2):1507-1526.
- Strub, P.T. and C. James. 2000. Altimeter-derived variability of surface velocities in the California Current System: 2. Seasonal circulation and eddy statistics. *Deep Sea Research Part II: Topical Studies in Oceanography* 47(5-6):831-870.
- Thomson, J., S. Elgar and T.H.C. Herbers. 2005. Reflection and tunneling of ocean waves observed at a submarine canyon. *Geophys. Res. Lett.* 32, L10602.

- Thomson, J., S. Elgar, T.H.C. Herbers, B. Raubenheimer and R.T. Guza. 2007. Refraction and reflection of infragravity waves near submarine canyons. *J. of Geophys. Res.*, 112, C10000, doi:10.1029/2007JC004227.
- Thomson, J., S. Elgar, B. Raubenheimer, T.H.C. Herbers and R.T. Guza. 2006. Tidal modulation of infragravity waves via nonlinear energy losses in the surfzone. *Geophys. Res. Lett.* 33.
- Tillotson, K. and P.D. Komar. 1997. The wave climate of the Pacific Northwest (Oregon and Washington): A comparison of data sources. *Journal of Coastal Research* 13(2):440-452.
- Ware, D.M. and R.E. Thomson. 2005. Bottom-up ecosystem trophic dynamics determine fish production in the northeast Pacific. *Science* 308(5726):1280-1284.
- Winant, C. and C. Dorman. 1997. Seasonal patterns of surface wind stress and heat flux over the Southern California Bight. *J. Geophys. Res.* 102(C3):5641-5653.
- Winant, C.D., E.P. Dever and M.C. Henderschott. 2003. Characteristic patterns of shelf circulation at the boundary between central and Southern California. *Journal of Geophysical Research* 108:3021, doi:10.1029/2001JC001302, 2003.
- Wyrski, K. 1975. El Niño-The dynamic response of the equatorial Pacific Ocean to atmospheric forcing. *Journal of Physical Oceanography* 5 (October):572-584.

2. GEOLOGICAL OCEANOGRAPHY

The Southern Study Area encompasses the coastal and shelf regions from northern Santa Barbara County to the Mexican border; however many of the geological features of the California coastline are closely linked or in contrast to features formed by tectonic processes that exist further north, in proximity to Monterey Bay and the central California coast. This chapter will refer to features within and outside the Southern Study Area to help the reader understand the context in which the geological features of the area are set.

North of Point Conception, the Southern Study Area exhibits a contiguous continental shelf, slope, and abyssal plain. In contrast, the offshore region from San Luis Obispo (Port San Luis) to the United States/Mexican border encompasses some of the most diverse undersea topography (bathymetry) along the West Coast of the United States. This physiography is unique in that the basin and ridges of the Southern California borderland (Figure 2.1) do not occur anywhere else along the northeastern margin of the Pacific Ocean (Lee and Normark 2009).

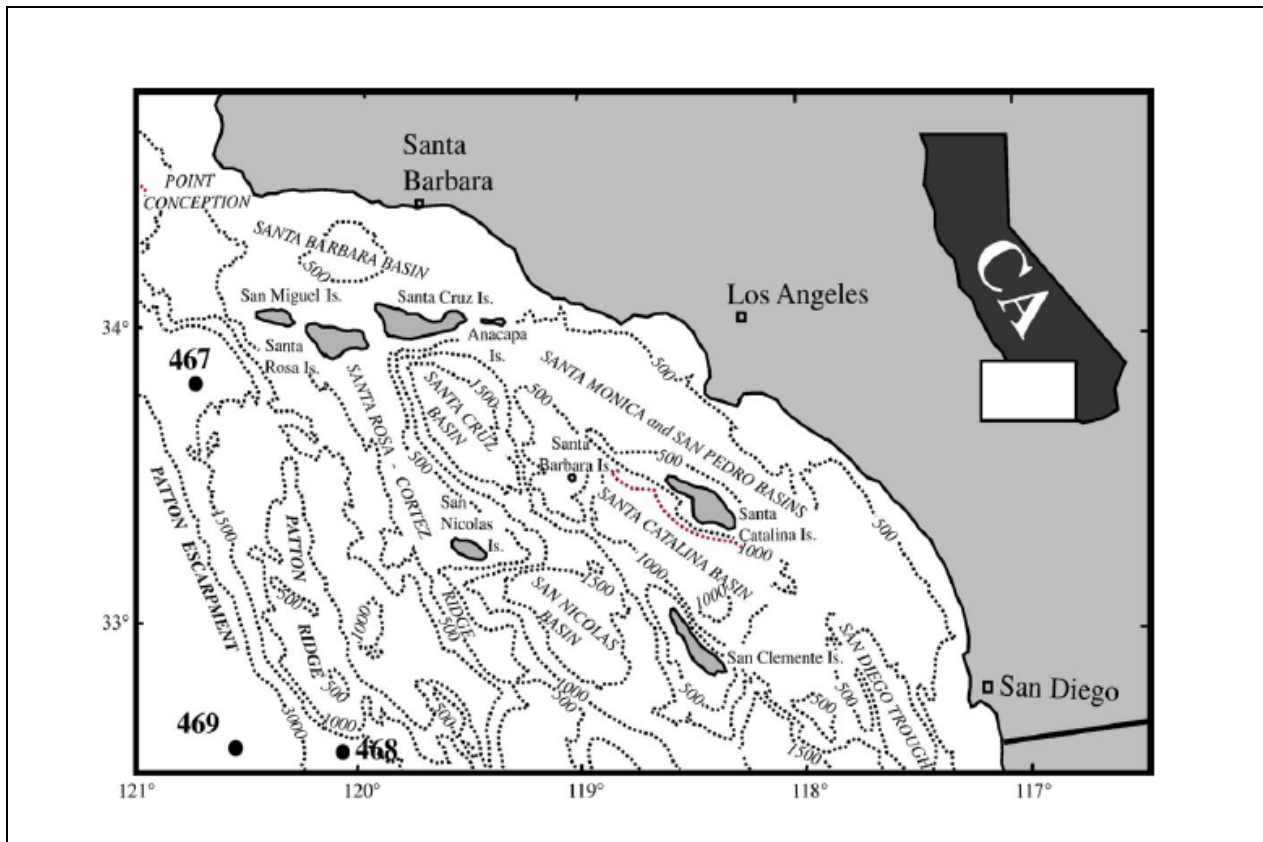

Figure 2.1 Elements of the California borderland.

The deep subsurface geology and tectonic history of this complex area has been investigated along the distal margin of the Southern California boarderland through the Deep Sea Drilling program numbered sites

From Marsaglia et al. (2006).

2.1 DESCRIPTION AND PHYSIOGRAPHY

The physiography of the Southern Study Area strongly reflects both past and recent tectonic activity, specifically in the fragmenting of the continental shelf into basins and ridges that separate the shallow inner shelf from the continental slope and abyssal plain. Many of the borderland ridges (e.g., Catalina, San Clemente, and Santa Rosa Ridges) support islands and banks while the basins function as depocenters that sequester sediment (Alexander and Lee 2009).

The Southern Study Area can be divided into two parts: the area north of Point Conception/Point Arguello and the continental borderland south of Point Conception. North of Point Conception, the continental margin is oriented primarily north-south and is relatively narrow compared to the southern part of the study area. Few banks and submarine canyons occur north of Point Conception with the exception of the multiple heads of Arguello and Conception Canyons (Vedder et al. 1986). In contrast, a complex series of basins and ridges characterizes the continental borderland south of Point Conception with islands topping most of the ridges.

Tectonically the Southern Study Area ranges from a transpressional regime with predominant strike-slip, wrench-fault deformation in the north to transtensional and rotational-like basin formation in the south associated with the San Andreas transform-fault zone. Separating these two tectonic settings is the offshore extension structure (faults and folds) of the Transverse Range where the restricting bend of the San Andreas Fault zone occurs (Crouch and Suppe 1993; Legg 1991; Fisher et al. 2009a; Ryan et al. 2009).

The right-lateral San Andreas Fault (SAF) system dominates the tectonic setting of California from the Salton Sea near the head of the Gulf of California to the offshore area of Cape Mendocino terminating at the Mendocino Triple Junction, a distance of 1300 km (Schultz and Wallace 1997). Many conjugate faults in the offshore California margin are associated with the San Andreas Fault system, including the San Gregorio-Hosgre Fault zone in the northern part of the southern area, and the Malibu Coast Fault at the boundary between the northern and southern portions of the Southern Study Area (Jennings 1992; Dickenson et al. 2005). Active seismicity along many of the offshore faults is responsible for the mass wasting that has occurred in the past (Fisher et al. 2009b; Lee et al. 2009).

South of Point Conception, the offshore structural grain of the Southern California borderland consists of northwest-southeast-oriented ridges and basins. The Patton Ridge and Escarpment was created as part of the continental margin; the feature has since been transferred to the Pacific plate after the Rivera Triple Junction evolved, and now forms a portion of the outer Borderland (Marsaglia et al. 2006). Microplate capture, associated with the evolution and repositioning of the transform fault between the North American and Pacific plates, has constituted the dominant tectonic process forming the structure and physiography of the borderland (Marsaglia et al. 2006). Structure associated with this process has been modified by transform fault motion, along with the deformation associated with this movement, at the “Big Bend” onshore in the San Andreas Fault.

Basement rocks of the Southern California continental borderland consist of pre-Late Cretaceous high-pressure schistose rocks, including undated zeolite-facies greywacke and argillites, Late Jurassic ophiolites, and, most likely, related schistose arc-volcanogenic rocks (Vedder 1987). Vedder (1987) separated these rocks into four major tectonstratigraphic units based on contrasting basement rocks and overlying stratigraphy, named from east to west: the Santa Ana, Catalina, Nicholas, and Patton. These terranes are separated along thrust faults and result from accretion during the subduction process that ended in the borderland during the Middle Miocene.

Shifts in plate motion direction during the latter stages of subduction and the initial development into a transform margin led to rotation of the borderland, resulting in transtension and volcanism along with unroofing of the Catalina Schist in core complexes between the Los Angeles Basin and the Nicholas Terrane (Fisher et al. 2009b). As early as 5 Ma (millions of years), the San Andreas transform Fault developed the “Big Bend” in the Transverse Range, which caused north-south compression. This activity led to the concept of “escape tectonics,” with structural elements rotating and squeezing out to the west around the bend, preventing the northward migration of these structural elements (Walls 1998; Fisher et al. 2009b).

2.1.1 Continental Shelf and Slope

North of Point Conception, the continental margin is oriented primarily north-south and is narrow compared to the Southern California continental borderland, which is exceptionally wide. In central California, the continental shelf is also relatively narrow; the continental shelf in the Monterey Bay area is about 30 km wide and in the Gulf of Farallones it is about 45 km wide. Between Point Sur and Point Buchon, the shelf width is very narrow (1-3 km). South of the Big Sur coast, the shelf widens to 15 km in both the Estero Bay (Morro Bay) and Port San Luis (San Luis Obispo) areas. Few banks and submarine canyons are located in the northern part of the Southern Study Area, with the exception of the multiple heads of Arguello and Conception canyons (Vedder et al. 1986). In stark contrast, a complex series of basins ([described in section 2.2.5](#)) and ridges ([described in section 2.2.4](#)) characterize the 280 km-wide Southern California continental borderland, which fragments the continental shelf south of Point Conception, extending from the Los Angeles-San Diego shoreline to the top of the Patton Escarpment at the head of the continental slope (Vedder 1987).

2.1.2 Submarine Canyons and Sea Valleys

The proximity of canyon heads to sediment sources largely controls the amount and nature of sediment entering deep water. The multiple heads of Arguello and Conception Canyons are located just offshore between Point Arguello and Point Conception. Bathymetric data suggest that these canyons host mass-movement features along their flanks and in their heads. Many of the slumps and landslide material mapped in these canyons appear fluid induced—most likely due to hydrocarbon leakage from the deep offshore Santa Maria Basin (Eichhubl et al. 2002).

Submarine canyons in the Southern California continental borderland generally connect to river or wash mouths on land. These canyons, from north to south, are: the Hueneme-Magu Canyon system, Dume Canyon, Santa Monica Canyon, Redondo Canyon, San Pedro Sea Valley, San Gabriel Canyon, Newport Canyon system, Oceanside Canyon, Carlsbad Canyon, La Jolla Canyon, and Loma Sea Valley (Greene et al. 1991). These canyons are generally active with

periodic turbidite flows occurring on decadal time scales and hyperpycnal flows occurring at least annually. Other offshore canyons, such as those associated with the islands and the sills of Santa Barbara Basin, appear not to be transporting sediment presently due to their isolation from major rivers and littoral sediment cells (Normark et al. 2009).

2.1.3 Seamounts

Seamounts are remnants of undersea volcanoes and are geologically important features that also support rich biological communities. North of Point Conception, a series of seamounts—Gumdrop, Guide, and Pioneer—protrude above an otherwise smooth continental slope near the mouth of Pioneer Canyon, about 100 km southwest of San Francisco Bay (McCulloch and Greene 1990; Greene et al. 2002). Davidson seamount lies 120 km southwest of Monterey Bay, rising 2,400 m from the sea floor to a depth of 1,200 m below the surface. The Davidson and Pioneer seamounts are unlike most intraplate ocean island volcanoes in that they developed on top of abandoned spreading center segments (Davis et al. 2007). South of Point Conception, seamounts from north to south include Rodriguez, San Juan, and San Marcos (Figure 2.2).

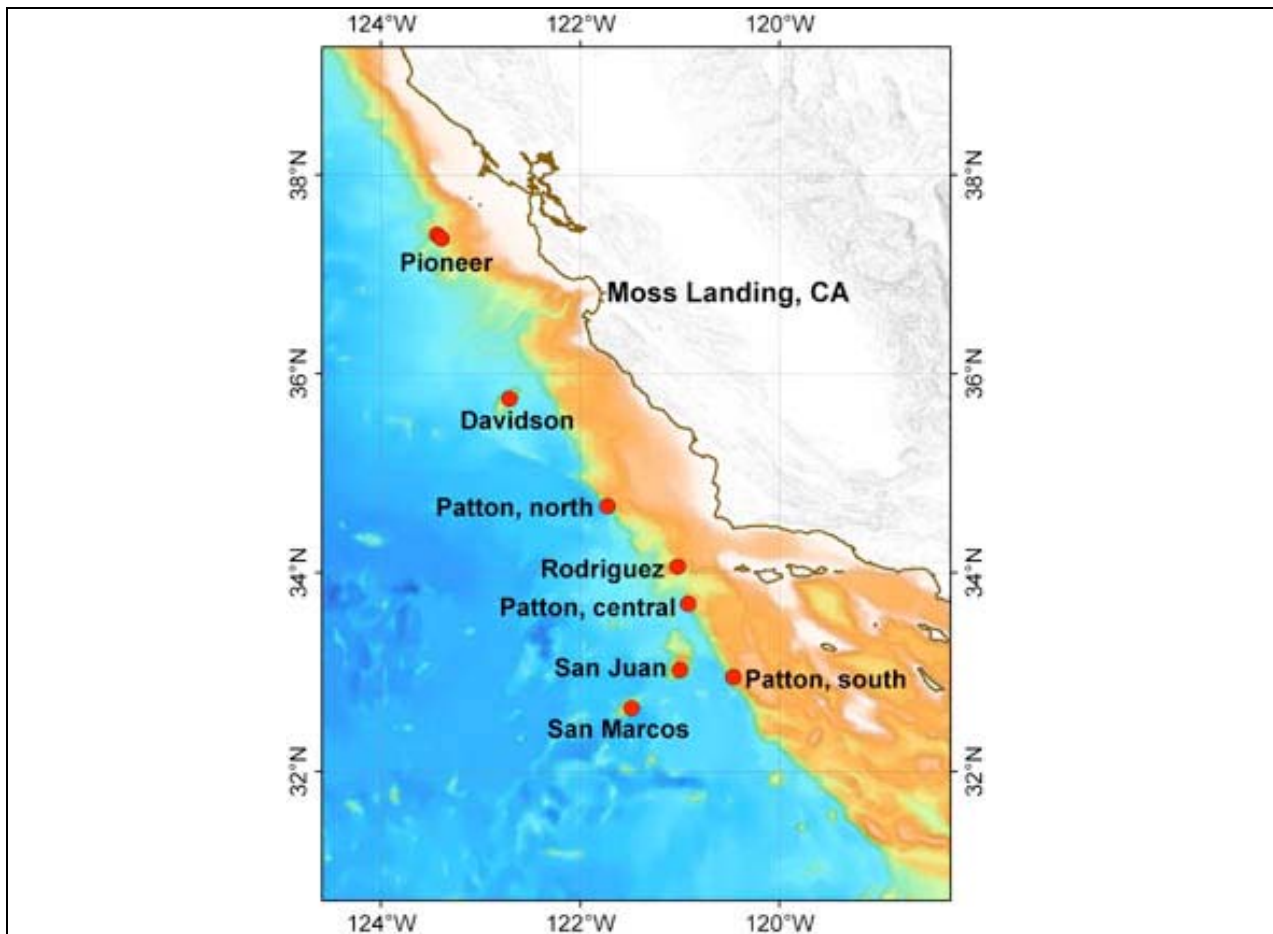

Figure 2.2. Seamounts in the Southern Study Area.

Monterey Bay Aquarium Research Institute 2007

2.1.4 Ridges and Banks

Basins and ridges characterize the continental margin south of Point Conception, with the Channel Islands topping most of the ridges. The major islands and banks (from north to south, east to west) are: Richardson Rock, Wilson Rock, and San Miguel, Santa Rosa, Santa Cruz, and Anacapa Islands on the Santa Cruz Ridge, which separates the offshore continental slope from the Santa Barbara Basin. The Catalina Ridge supports the Pilgrim Banks (31-m crest depth) and Catalina Island; the San Clemente Ridge supports Santa Barbara Island, Osborn Bank (49-m crest depth), and San Clemente Island; the Santa Rosa-Cortes Ridge supports Begg Rock (5-m crest depth), San Nicholas Island, Nidever Bank (91-m crest depth), Dall Bank, Tanner Bank (22-m crest depth), and Cortes Bank (4-m crest depth). The Patton Ridge, which supports Sverdrup Bank and Escarpment, is a major bathymetric feature that separates the borderland from the abyssal plain and represents the frontal part of a former accretionary wedge. Several other isolated submarine banks and knolls not supported by ridges include: Redondo Knoll (495-m crest depth), Trask Knoll, Valon Knoll (417-m crest depth), Emery Knoll (722-m crest depth), Larson Knoll, Crespi Knoll, Albatross Knoll, Coronado Bank, Thirtymile Bank, Fortymile Bank, Santo Tomas Knoll, Blake Knolls, Sixtymile Bank, Shepard Knoll, and Northeast Bank (337-m crest depth). In addition, researchers have mapped a series of unnamed banks, knolls, and seamounts in the southern area of the Southern Study Area (Vedder et al. 1986; Vedder 1987; Vedder et al. 1987; McCulloch 1989; Ryan et al. 2009).

2.1.5 Basins of the Continental Shelf and Slope

The basins of the Southern Study Area are located primarily south of Point Conception. The structural grain of this area consists of northwest-southeast-oriented ridges and basins. From north to south, east to west, the basins consist of Santa Barbara (625 m), Santa Monica (911 m), Gulf of Catalina (<800 m), San Pedro (<900 m), San Diego Trough (<1000 m), Santa Cruz (1957 m), Patton, San Nicholas (<1750 m), San Clemente (2107 m), East Cortes (1765 m), West Cortes (1628 m), Tanner (1463 m), Long (1847 m), and Velero Basins.

Water circulation in the basins is constrained below the basin sills; some of these sills intersect the oceanic oxygen minimum zone. General circulation within these basins is greatly reduced by landmasses and coastal mountain topography. These restricted basins act as depocenters that sequester sediment (Alexander and Lee 2009).

2.1.6 Deltas and Submarine Fans

Submarine channels and canyons are the main conduits for sediment transfer to the deep sea. Turbidity currents, fast moving flows of terrigenous sediment, deposit coarse-grained layers of sediment interleaved by fine-grained sediments; these features are known as turbidites. The Monterey Submarine Fan is one of the largest turbidite systems off the western United States, encompassing up to 600 m of deposition that accumulated in less than a million years (Fildani and Normark 2003). South of Point Conception, fan construction is most active in the inner and central basins, which have access to large insular or mainland sediment sources (Schwalbach et al. 1996). Turbidity currents generated within submarine canyons deposit turbidites at the base of the mainland slope near the mouths of the canyons. Submarine fans constructed from turbidity currents and deposited in the Santa Monica Basin include (from north to south): the large

Hueneme Fan, the small Magu and Dume Fans, and the very small Santa Monica Fan. The size of each of these fans is indicative of the amount of material delivered to the canyon heads, which dictates the frequency of turbidity current events.

In the case of Hueneme Canyon, the Santa Clara River has migrated back and forth on the coastal plain, producing a substantial delta that feeds the five canyons of the Hueneme-Magu Canyon system. Turbidity currents traveling down Redondo Canyon and the San Pedro Sea Valley have constructed moderate-size fans in San Pedro Basin. Turbidity currents originating in San Gabriel Canyon have traveled a long distance to construct a submarine fan in the Catalina Basin. In contrast, the neighboring Newport Canyon system focuses turbidity currents into the Gulf of Catalina and through the San Diego Trough. Turbidity currents originating in Oceanside, Carlsbad, and La Jolla Canyons have swept sediment to the floor of the Gulf of Catalina, building a coalescing series of turbidite fans. Similar currents originating in Loma Sea Valley have constructed a fan in the southern part of the San Diego Trough as well as one in the San Clemente Basin (Normark et al. 2009). No major submarine canyons exist in the Santa Barbara Basin region, although gullies do occur. Gullies concentrated on the northern flank of the basin feed sediment to the Conception Fan (Eichhubl et al. 2002; Lee et al. 2009).

2.2 DISTRIBUTION AND FATE OF CHEMICAL CONSTITUENTS IN SEDIMENTS

Chemical constituents are introduced to the marine environment by both natural and anthropogenic means. Natural erosion of onshore material and exposed bedrock on the shelf separates and concentrates minerals that are then transported to regions of deposition where they may be further concentrated. Industrial and urban waste disposal can introduce anthropogenic compounds to the marine environment. Waste products are often caught up in stormwater runoff on land where they are transported by fluvial processes and delivered to the marine environment.

The distribution and fate of chemical constituents in continental shelf sediments include mineralization and dissolution of particulate organic matter. Shum and Sundby (1995) conclude that the passage of gravity waves and bottom currents over irregular surfaces of the continental shelf can enhance organic mineral crystallization in sandy shelf substrates. There is little information that directly pertains to the Southern Study Area, however in the Monterey Bay area, metal fluxes from sediment are higher in areas with elevated rates of organic carbon remineralization, such as upper shelf waters. The flux of metals (manganese, copper, and iron) is lower in deep waters associated with an oxygen minimum zone (Johnson et al. 1992).

For more on the distribution and fate of chemical constituents, [see Chapter 3 on Chemistry](#).

2.2.1 Sedimentary Organic Matter

Terrigenous fine silt and clay tend to remain in suspension after entering the marine environment. Because coastal waters are biologically productive, much of this material may pass through the organisms' guts and be excreted as particulate aggregates with some organic material. In general, up to 90 percent of terrigenous sediments settle within a few hundred kilometers of their source (Hein and Gorsline 1980). In Monterey Bay, approximately 60 to 70 percent of sediments enter from coastal streams; the majority of these sediments fall from suspension within a few kilometers of shore in water depths of less than 40 m (Best and Griggs

1994). Sediments on the California continental shelf that are not directly affected by nearby river input are largely relict, originating primarily when sea level was lower and subaerial erosion occurred during the Pleistocene; most of the terrestrially sourced sediments are captured in continental borderland basins (de Haas et al. 2002).

Twenty-five percent of the sedimentary organic matter comes from river input; the rest comes from primary production in the marine environment (de Haas et al. 2002). River influx is highest in winter; biogenic primary production is seasonal, increasing with spring-summer upwelling. Upwelling and sediment transport are influenced by the south-moving California Current, one of the currents in the California Current System (CCS) that extends from British Columbia to Baja, California (Yamamoto et al. 2007). The south-flowing California Current exhibits diverse regional characteristics and intricate eddy motions, significantly influencing biogeochemical distributions and nearshore waves and currents. Larger-scale eddies occur near topographic features and transport materials away from the shelf while wind-driven summer upwelling is typically located south of headlands (Hickey 1998). Thornton (1981) documented semi-permanent cyclonic gyres and associated spinoff eddies controlling surface suspended sediment throughout the California borderland; they are also likely to control resulting sedimentation patterns of terrigenous silt and clay and associated organic matter.

2.2.2 Composition of Sedimentary Organic Matter

Sedimentary organic material is composed largely (approximately 75 percent) of carbonate, silica, and organic material from primary production activities, with approximately one quarter of the deposited material contributed by rivers (de Haas et al. 2002).

Anthropogenically introduced particulate organic carbon and dissolved organic carbon in Monterey Bay include synthetic organics and aromatic hydrocarbons typical of pesticides and petroleum products (de Lappe et al. 1983). As of 1989, approximately three-quarters of the municipal effluent from Southern California coastal counties was directly discharged into coastal waters. Up to 30 percent of the particles in municipal wastewater consists of organic carbon. Most of the industrial wastes, which make up about 9.1 percent of the total municipal wastewater, originates from petroleum-related activities, including production, shipping, and associated tanker activities (Dailey et al. 1993).

2.2.3 Trace Metals

In general, marine sediments rich in clays tend to retain heavy metals and phosphorus. The heavy metals manganese, chromium, zinc, nickel, and copper are enriched in wastewater outfall at Punta Bandera on the Baja coast, but do not seem to be retained in fine sediment. The metals cadmium and mercury appear to be trapped by biogenic processes and deposited separately (Villaescusa-Celaya et al. 2000). For more on trace metals, [see Chapter 3 on Chemistry](#).

2.2.4 Early Diagenetic Processes

Early diagenetic processes include mineralization and dissolution of particulate organic matter on the continental shelf; both are enhanced by the passage of gravity waves and bottom currents over irregular sandy surfaces (Shum and Sundby 1995). Other early diagenetic processes include

deposition of carbonate related to methane seeps. Relict sediments in areas of low sediment accumulation rates may undergo replacement by phosphate minerals.

2.3 GEOLOGIC HAZARDS

In the Southern Study Area, the origin of most geologic hazards is tectonic, including earthquakes and their consequences. Moderate-to-large seismic events can destabilize sediment and rocks on the continental slope and on submarine canyon walls. These failures can range in magnitude from small sediment creep or turbidity flows to mass wasting, such as rock avalanches or slumps and turbidity currents (gravity currents). Sudden or large-scale failure of a slope or canyon wall can generate a tsunami. Other less consequential, but still serious, hazards include erosion and scouring by bottom and turbidity currents, fluid expulsion and liquefaction, and mass wasting through creation of rills and formation of gullies. Fault rupture, expressed in sea floor offsets and deformation, can also pose hazards in the Southern Study Area.

2.3.1 Scouring Action of Bottom Currents Including Turbidity Currents

Scouring and erosion on the sea floor and within submarine canyons occur primarily by two different processes: (1) strong bottom currents generated during storms; and (2) gravity-driven turbidity currents that transport sediment downslope, generally in submarine canyons. Storm-generated scouring and erosion are primarily restricted to the continental shelf and are particularly significant during times of El Niño-Southern Oscillation (ENSO) events, coincidental with the influx of fluvial and eroded bluff sediment, generally at decadal recurrence intervals (Warrick and Farnsworth 2009). Sediment accumulations generally decrease in the offshore direction and are primarily transported within small littoral cells (Alexander and Lee 2009). Fine-grain turbidity currents are generated along the distal edge of the continental shelf and erode the slope (Sommerfield et al. 2009). Scouring is most prominent where impediments, such as rocks, wrecks, or infrastructure (e.g., pipelines, platforms) rise above a flat sea floor. Variable rock outcrops that exist offshore of major prominences disrupt bottom currents resulting in scour. Oil and gas platforms in the Southern Study Area are generally located in areas of high scouring.

Turbidity currents are most common in submarine canyons but can also occur along the continental slope, especially in areas where substantial quantities of sediment are delivered to the marine environment, such as offshore of major river mouths. In the Southern Study Area, the major rivers and creeks from north to south that supply sediment to the marine environment (and consequently to the heads of submarine canyons) are: the Ventura River, Santa Clara River, and Callegus Creek into the Santa Barbara Channel area; the Malibu Creek and Ballona Creek into Santa Monica Bay; the Los Angeles River, San Gabriel River, and Santa Ana River into the northern Gulf of Catalina; and the San Jose Creek, Santa Margarita River, San Luis Rey River, San Diego River, Sweetwater River, and Tijuana River into the southern Gulf of Catalina (Sommerfield et al. 2009; Edwards et al. 2009; Hanson et al. 2009). The rivers that provide the greatest quantity of sediment are furthest north, with the Ventura and Santa Clara Rivers providing large amounts of sediment (Warrick and Farnsworth 2009). The rivers and creeks south of Point Dume drain a more arid portion of the study area and contribute less sediment to the marine system. Nevertheless, significant amounts of material can enter the littoral cells during ENSO events.

Submarine canyons interrupt the littoral transport of sediment and redirect this material to the deepwater parts of the borderland, mainly into the basins. Often the transport mechanism is a turbidity current, which results from the mass failure of materials that accumulate at the head of a canyon or along the walls of a canyon; an earthquake or storm event generally triggers the failure. The recurrence interval of a turbidity current, therefore, generally relates to the frequency of earthquakes within the region or to severe storm disturbances, such as those that occur during ENSO events (at decadal to century time scales). Slope failures also occur, but not as frequently as failures within canyon heads. The submarine canyons that incise the narrow continental shelf of mainland California from north to south are: the Hueneme-Magu Canyon system, Dume Canyon, Santa Monica Canyon, Redondo Canyon, San Pedro Sea Valley, San Gabriel Canyon, Newport Canyon system, Oceanside Canyon, Carlsbad Canyon, La Jolla Canyon, and Loma Sea Valley. All of these canyons have active turbidite channels and most, with the exception of the three intermediate canyons between Hueneme and Magu Canyons, Santa Monica Canyon, San Pedro Sea Valley, San Gabriel Canyon, Newport Canyon system, and Oceanside Canyon, head at or near the shoreline. All of the canyons that notch the distal edge of the shelf are able to intercept sediment that crosses the shelf (Normark et al. 2009).

Turbidity currents generated within submarine canyons deposit turbidites as submarine fans at the base of the mainland slope near the mouths of the canyons ([see section 2.2.6](#)).

2.3.2 Mass Wasting – Slope and Canyon Wall Failures

The Central and Southern California margin is heavily incised with canyons and gullies and contains extensive submarine slide scars. The types of submarine features that have been mapped along the California margin include thin sediment or mud flows, debris flows, down-dropped blocks and rotational slumps, rock falls, rock debris avalanches, and compound mass-movement features (Greene et al. 2002; Eichhubl et al. 2002; Bohannon and Gardner 2004). These failures occur at all depths along the margin, ranging from those in less than 100 m water depth within the heads of submarine canyons to others along the base of the continental slope at depths approaching 3500 m (Gutmacker and Normark 1993; Greene et al. 2002). In addition, trans-terrestrial slides occur along the steep coasts and narrow shelf areas, such as those along the western margin of the Santa Lucia Mountains (Big Sur coastline), the Santa Monica Mountains or Transverse Range where modern subaerial inputs contribute to ongoing submarine mass movement, and the Palo Verdes Hills (Greene et al. 2006; Summerfield et al. 2009; Normark et al. 2009).

Large landslides and mass sediment transport are generally restricted to the submarine canyons and steep continental and island slopes or basin flanks. The largest landslide mapped in the area is the Goleta Slide in Santa Barbara Channel—a complex compound slide in which any one of its three lobes could have produced a tsunami if failure had occurred instantaneously. The estimated age range of the Goleta Slide is ~200 ka (thousand years) to 8-10 ka represented in more than 24 major failure events. Additional mass movement features have been mapped along the northern flank of the Santa Barbara Basin, which indicates an area of instability. To the north, landslides along the western margin of the Santa Lucia Mountains occur, but these are not as large as the Goleta slide and may not be a severe threat for tsunami generation. The small

Gaviota Mudflow has an estimated age of 300 years and may have been responsible for the tsunami of 1812, however, no direct evidence connecting the seismic event with the tsunami has been reported. The next largest slide in the Southern Study Area is a rock avalanche deposit mapped at the base of the eastern San Pedro Basin flank and a large landslide zone on the northern flank of the Santa Cruz Basin, which could have produced tsunamis if failures were instantaneous (Eichhubl et al. 2002; Greene et al. 2002; Greene et al. 2006; Lee et al. 2009; Fisher et al. 2009a; Fisher et al. 2005). Similar to the Gaviota Mudflow no direct evidence of a tsunami generated from the rock avalanche has been reported.

Mass movement is the most dominant sediment transport process of the slopes of the inner and central basins of the northern half of the borderland, (north of San Diego) and is directly related to sedimentation rates, which can be zoned as in [Figure 2.3](#). Within Zone 2, Holocene sedimentation rates have exceeded 30 mg/cm²/yr, which appear to be the critical rate that permits large-scale mass-wasting processes to commonly occur. In Zone 1 (the Santa Barbara Basin), rates exceed 50 mg/cm²/yr, and mass-wasting processes dominate slopes with gradients of as little as one degree or less (Hein and Gorsline 1980). Of the sediment discharged from the Santa Clara River, 10 to 30 percent is retained on the Santa Clara River shelf while 70 to 80 percent is redistributed to the outer shelf, slope, and Santa Barbara Basin (Alexander and Lee 2009).

The bulk properties of fine-grained materials may indicate the likelihood of mass movement, but further observations need to be undertaken to confirm this hypothesis. Comparisons of hemipelagic sediment in the Santa Barbara, Santa Cruz, and San Nicolas Basins show that different types of mass-transported sediment have different properties, although their lithology and sedimentologic properties remain quite similar. Slump deposits have moderate water content and high plasticity indices; debris flows have low water content and plasticity indices; liquefied flows, mudflows, and turbidites have high water content and plasticity (Hein and Gorsline 1980).

The Santa Monica margin does not display evidence of mass wasting as an important process of sediment delivery and distribution; the San Pedro region does. Deposits within the San Pedro Basin exhibit evidence of turbidites tentatively associated with both major floods and earthquakes sourced either from Dume or Redondo Canyons (Alexander and Lee 2009). A major rock avalanche and landslide scarp on the San Pedro Escarpment has an estimated age of 7.5 ka (Lee et al. 2009). The Newport Canyon system appears to be associated with mass movement as well as mass wasting. South of Newport, offshore of San Mateo Point, a submarine slump has been mapped in association with the southwest-verging San Mateo Thrust Fault. Older, Miocene or Pliocene landslides have been mapped on Thirtymile and Fortymile Banks as well as along the Santa Rosa-Cortes Ridge (Lee et al. 2009). Many other mass-wasting features may exist in the Southern Study Area, but remain undetected due to the lack of sophisticated high-resolution acoustic mapping in the region.

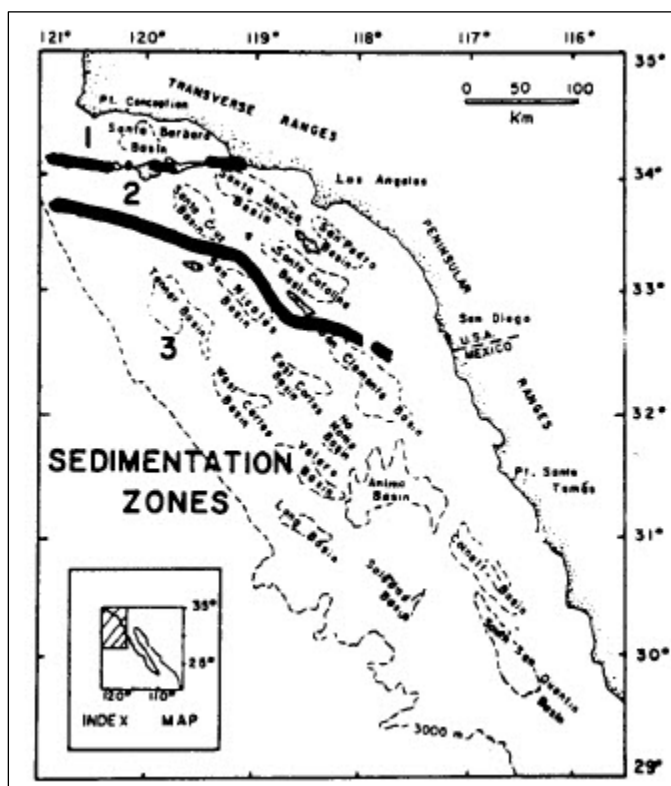

Figure 2.3. Sedimentation rates in the California borderland. Zone 2 has Holocene rates exceeding $30 \text{ mg/cm}^2/\text{yr}$.

Along with Zone 1, this zone is an area of common mass wasting.

(Hein and Gorsline 1980).

2.3.3 Faulting, Warping, and Deformation

The right-lateral San Andreas Fault (SAF) system dominates the tectonic setting of California from the Salton Sea near the head of the Gulf of California to the offshore area of Cape Mendocino, where it terminates at the Mendocino Triple Junction, a distance of 1,300 km (Schultz and Wallace 1997). The onshore SAF is commonly divided into several segments for discussion. The northern segment extends from Point Arena to San Francisco Bay; a section defined by creep rather than large offset events extends from near Monterey to Parkfield; a short 30-km Parkfield segment appears to move independently of other segments; a central segment reaches from Parkfield to Cajon Pass near San Bernardino; and a 300-km segment extends from the Cajon Pass to the Salton Sea. Many conjugate faults in the offshore California margin are associated with the SAF system including the San Gregorio-Hosgre Fault zone in the northern part of the southern area and the Malibu Coast Fault. Average recurrence times of large events on the southern part of the SAF are 200 to 300 years, with average displacements of 5.5-7 meters. The southern part of the SAF is likely in the late stage of its interseismic recurrence (Fialko 2006).

Much of the area offshore of Southern California is zoned with a high shaking hazard (Ross et al. 2008). The severity of seismic-induced shaking is a function of earthquake magnitude, distance from the epicenter, and geologic conditions at a given site. Active seismicity along many of the offshore faults is responsible for the mass wasting that commonly occurs. Primary effects of seismic activity along faults include permanent deformation of the ground as well as shaking. Seismic shaking commonly produces landslides, liquefaction, debris flows, turbidity currents, and landslide-induced tsunamis. Ground motion may be amplified in sedimentary basins due to resonance (Ross et al. 2008) and is dependent upon substrate types.

Although fault activity in the offshore regions of the Southern California continental borderland appears less severe than onshore due primarily to the greater distance of the region from the San Andreas Fault, earthquakes and fault motion still occur (Figure 2.4). Generally the region has been subjected to moderate magnitude earthquakes (M 5-6), with most of the activity occurring on the nearshore faults or the faults closest to the San Andreas Fault (Fisher et al. 2009a).



Figure 2.4. Relative motion on the main trace of the San Andreas Fault system.

The fault system runs offshore at Pacifica in San Mateo County, north of San Francisco.

Graphic from Wikipedia.com.

Two major fault trends occur in the Southern Study Area: primarily east-west oriented faults in the northern part of the area north of the Palos Verdes Peninsula with north-south orientation south of the peninsula. Major offshore faults in the north consist of the South Branch Santa Ynez Fault, Pitas Point-Red Mountain-North Channel Fault zone, Oak Ridge Fault, Santa Cruz Island and Santa Rosa Island Faults, Malibu Coast Fault, and Dume Fault. All but one of these faults are thrust and have earthquake fault-plane solutions that indicate reverse movement, with the exception of the Santa Cruz Island Fault where first motions solutions indicate a strike-slip motion. One fault—the Santa Monica Fault in Santa Monica Bay—has a more north-south

orientation than do faults to the north. Major offshore faults in the south (from east to west, north to south) consist of: the Newport-Inglewood-Rose Canyon Fault zone, Palos Verdes Fault, Cabrillo Fault, San Pedro Basin Fault, San Mateo-San Onofre-Carlsbad Fault zone, Coronado Bank Fault, San Diego Trough Fault, and San Clemente Fault. Fault-plane solutions of earthquakes along the Newport-Inglewood-Rose Canyon Fault zone, San Clemente Fault, and other faults offshore indicate strike-slip motion. Solutions along the San Mateo-San Onofre-Carlsbad Fault zone, Coronado Bank, and San Diego Trough Faults indicate reverse movement (Fisher et al. 2009a,b; Ryan et al. 2009).

Two historically recorded moderate earthquakes have occurred offshore in the southern part of the study area on the Newport-Inglewood-Rose Canyon Fault zone (1933 M 6.3 Long Beach Earthquake) and on the San Clemente Fault (1986 M 5.3 oceanside earthquake), which caused damage to structures on land (Ryan et al. 2009). Potential for moderate earthquakes still exists in the region. Onshore earthquakes appear to have stimulated offshore sea floor failures, such as the M 7.5 earthquake that occurred in 1812 with a reported tsunami (Greene et al. 2006).

2.3.4 Tsunamis

Although the Southern Study Area has not been severely impacted in the past by tsunamis, the potential for local tsunami generation exists, as does the potential for teleseismic tsunamis, those tsunamis generated by seismic activity from distances of 1000 km or more. No well-identified tsunami runup deposits on land have been confirmed. Reports of wave runup in canyons north of Santa Barbara after the Earthquake of 1812 and shortly after the 1933 Long Beach Earthquake have been made, both evidently referring to locally generated events. Damage from a tsunami generated during the 1964 Alaska Earthquake was reported from the Los Angeles-Long Beach areas several hours after that event occurred. Modern acoustic sea floor mapping offshore suggests that large mass-movement features there had the potential to generate sizable tsunamis and that the risk still exists for such failures to occur in the future (Borrero et al. 2001; 2004).

Several large landslides mapped in the Southern Study Area appear to have had the potential to generate a sizable tsunami if failure had been rapid. The most prominent failure is the Goleta Slide; its failure surface covers over 130 km² and exhibits three major failure lobes and multiple depositional wedges. Although no tsunami deposits have been found on land, ruling out that one or more of the Goleta Slide events generated a tsunami is not possible. A more recent slide (~300 years ago), but much smaller in size (3.78 km²), was proposed as the possible trigger of the tsunami of 1812 (Edwards et al. 1995; Fisher et al. 2005; Greene et al. 2006; Lee et al. 2009). The Palos Verdes Debris Avalanche located on the Palos Verdes Escarpment just offshore of the Palos Verdes Peninsula is also a major landslide feature that could have produced a tsunami (Lee et al. 2009).

Modern sea floor mapping in the nearshore areas of the Southern Study Area indicates that mass movement occurred in the past and is most likely active today. In the northern part of the study area, a propagating crack-and-slope bulge associated with the head scarp of the western lobe of the Goleta Slide suggests that the next slope failure to occur in the Santa Barbara Channel could be at this location. The entire eastern flank of the Santa Barbara Basin between the Goviota Mudflow and the Goleta Slide appears prone to failure, based on the multibeam bathymetry

image of a fairly continuous propagating crack along the upper slope edge ([Figure 2.5](#)). If a large and rapid failure occurred, a tsunami could be generated. Since earthquakes are the primary triggering event for mass movement, fixing the recurrence rate of mass movement and tsunami generation to recurrence levels of moderate (M 7 or greater) earthquakes in the region seems reasonable (Greene et al. 2006; Lee et al. 2009).

Locally generated tsunamis can occur from local failures along the walls and heads of submarine canyons. Since many of the submarine canyons that notch the distal edge of the continental shelf are fault-controlled and have been offset along such faults as the Newport-Inglewood-Rose Canyon Fault zone (e.g., La Jolla Canyon, Oceanside Canyon), destabilization of materials in canyon heads and on the walls can result in small tsunamis. Close proximity to active faults and the potential for fault rupture and ground shaking at or near submarine canyons make these features extremely prone to failure and to generation of turbidity currents and tsunamis (Greene et al. 1991).

2.3.5 Fluid and Gas Expulsion (Overpressure Zones)

Major oil and gas seeps occur in the Santa Barbara Channel where active hydrocarbon extraction is occurring today. Coal Oil Point is a historical gas seep area on the nearshore continental shelf near the town of Santa Barbara, but gas venting in deeper waters on the sea floor with modern carbonate construction has been observed in the southern part of the Santa Barbara Basin. Ancient and modern tar flows are present on the shelf and eastern flank of the northwestern flank of the Santa Barbara Basin (Eichhubl et al. 2002). [Section 3.4](#) has more information on marine seeps in the Santa Barbara Basin.

2.3.6 Irregular and Hummocky Topography

The Monterey Canyon displays large wave-shaped bedforms with vigorous sediment transport events in the upper canyon and recurrence intervals of less than one year (Paull et al. 2007). Similar features have been mapped in the Huneme-Magu canyon complex and indicates that such bedforms could be found in many other submarine canyons once they were surveyed with high-resolution acoustic multibeam bathymetric systems.

2.3.7 Rilling, Gullying, and Sediment Transport

General models of transport of sediment by submarine canyons and gullies have been developed on passive margins. In a passive margin setting, sediment can be transported to the deep basin via submarine canyons during low stands of sea level where sediment can accumulate in shelfal environments during high stands. In a tectonically active margin, such as that offshore central and Southern California, some submarine canyons stay connected to sources of sediment from prograding deltas and thus deliver river-derived, fine-grained sediment to the basin or coarse-grained sediment to submarine fans where rivers are not present and where longshore currents dominate shallow sediment transport (Covault et al. 2007). In shelfal areas with low sedimentation, most of the sediment is most likely relict and offshore sedimentation is probably dominated by deposition of fine suspended sediment and biogenic pelagic sediment (Warrick and Farnsworth 2009).

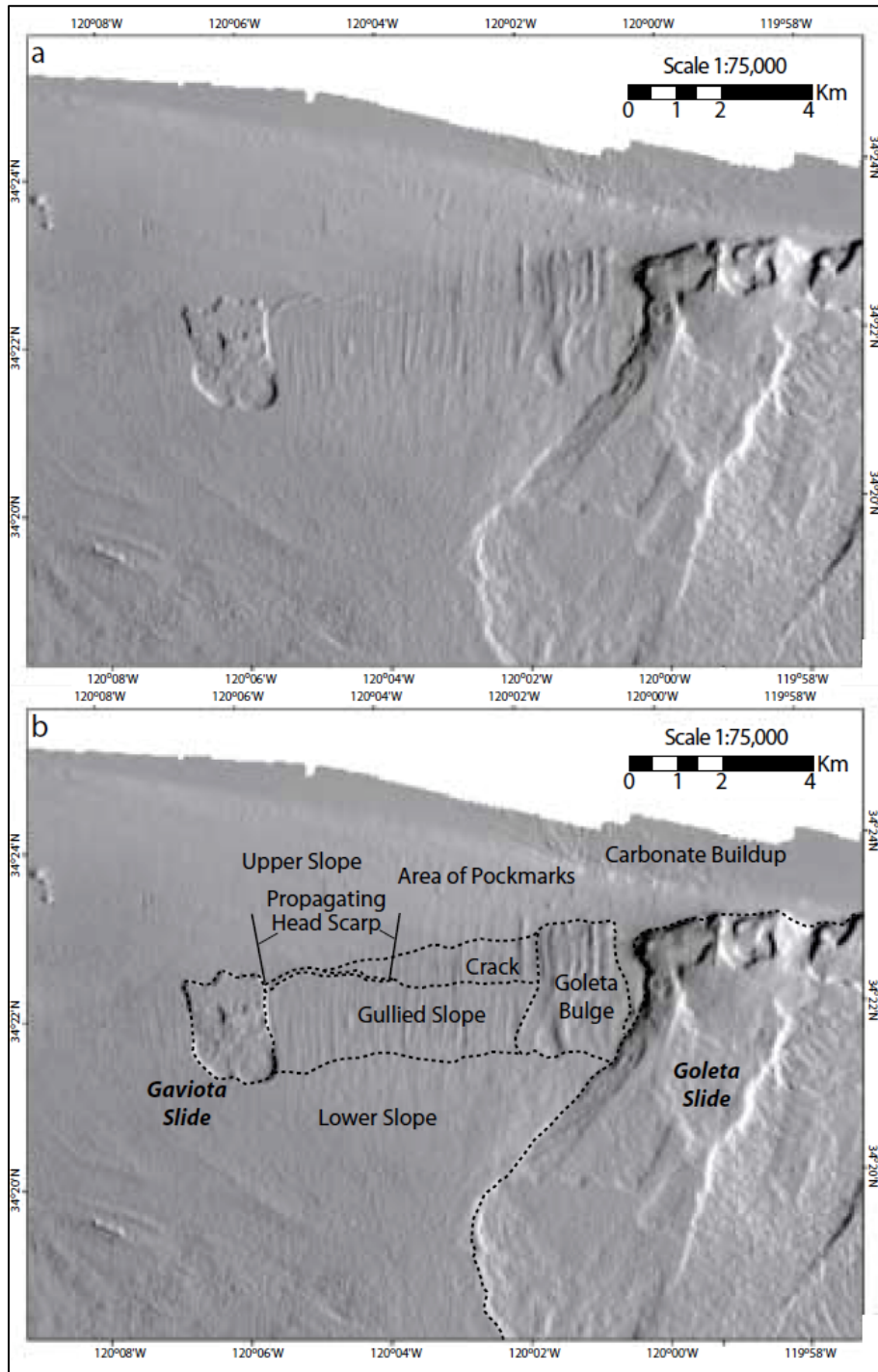

Figure 2.5. The western segment of the Goleta slide and propagating crack: (a) slope shaded EM300 multibeam bathymetry showing the western lobe of Goleta slide and adjoining area including the Gaviota slide and propagating head crack, (b) interpretations of morphologic features.

From Greene et al. 2006.

In Monterey Bay, approximately 60 to 70 percent of sediments enter from coastal streams; the majority of these sediments are deposited within a few kilometers of shore and in water depths of less than 40 m (Best and Griggs 1994). Sediments on the California continental shelf away from river input are largely relict and most of the terrestrially sourced sediments are captured in continental borderland basins (de Haas et al. 2002).

Most of the sediment entering the shelf of central and Southern California is lithogenic and comes from fluvial input. Sediment influx is much higher following the rainy season (Thornton 1981). [Figure 2.6](#) offers an example of marine surface turbidity following a rainy season. The Santa Maria River, San Antonio Creek, and Santa Inez River produce turbidity plumes in the northern part of the borderland that are carried south beyond Point Arguello. At other times, this plume extends south to Point Conception and into the Santa Barbara Basin. Eddies, currents, and gyres perturb influx and control much of the distribution of the suspended sediment (Thornton 1981). The Santa Clara River supplies sediment that is primarily transported northward toward Point Conception during flood stages and storms in the winter.

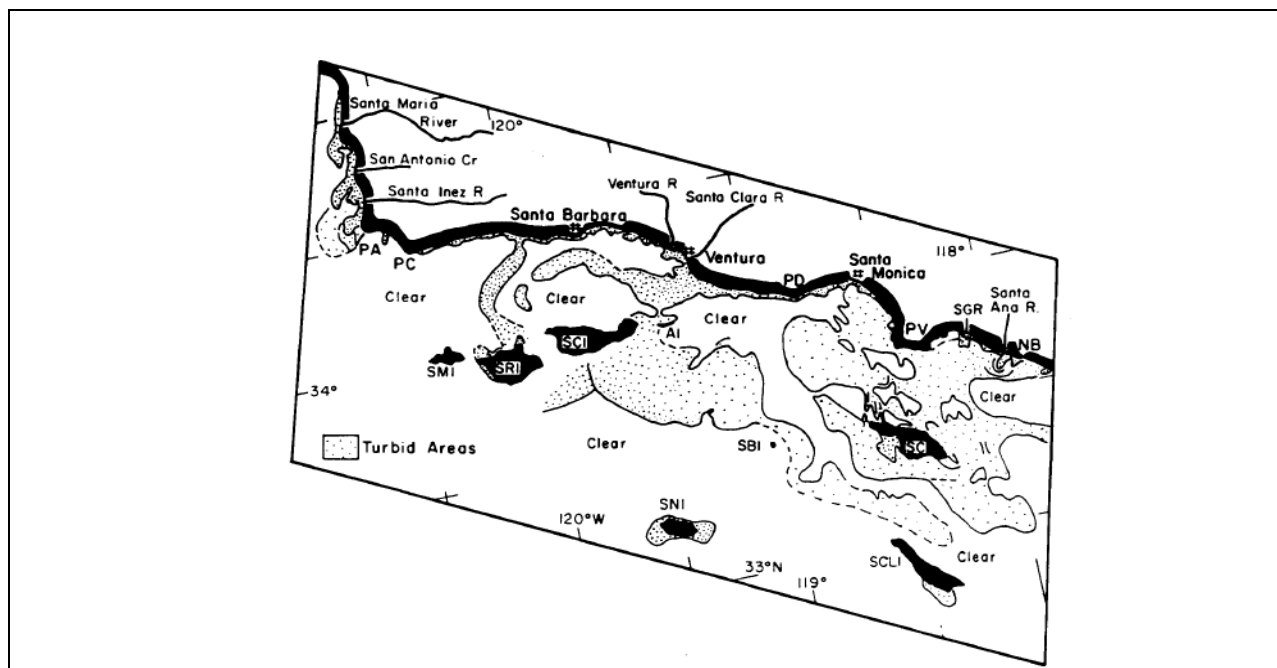

Figure 2.6. Patterns of surface water turbidity following rainy season storms of January, 1978.

Abbreviations of selected locations are: PA, Point Arguello; PC, Point Conception; NB, Newport Bay; SNI, San Nicholas Island; and SCL1, San Clemente Island.

From Thornton 1981.

In contrast to the fine-grained sediment delivered to the basin from river systems, the La Jolla submarine canyon delivers coarse-grained sediment to deep submarine fans as a consequence of the nearshore position of the canyon head. Longshore drift (littoral currents) transports near-shore sand from great distances during the current high stand of sea level. Because the heads of most gullies or canyons are situated at the shelf edge, the La Jolla oceanside littoral cell collects

sand from a greater distance and produces one large submarine fan instead of several smaller ones (Covault et al. 2007; Sommerfield et al. 2009).

Seasonal variability in fine sediment influx appears to control varve formation in the deep Santa Barbara Basin. Sediment influx throughout the year is dominated by lithogenic material; biogenic sediment (primarily silica) is secondary. In winter, high influxes of lithogenic sediment, together with low production of biogenic sediment, yield dark-colored sediment laminae. The onset of spring upwelling and the increase in biogenic silica production result in light-colored laminae (Thunell et al. 1995). In contrast, laminated sediments in the Santa Monica Basin appear to represent multi-year couplets, possibly corresponding to ENSO phenomena (Hagadorn et al. 1995). [Figure 2.3](#) shows zones of Holocene sedimentation rates within the California borderland Zone 1, the Santa Barbara Basin, has the highest rate of 50 mg/cm²/yr; Zone 2 has sedimentation rates above 30 mg/cm²/yr; Zone 3 has rates of generally less than 10 mg/cm²/yr. The incidence of mass wasting positively correlates with slope and sedimentation rates (Hein and Gorsline 1980).

Of greater importance than the annual average sediment contribution are the decadal and generational floods of Southern California that discharge one to three orders of magnitude more sediment. These floods can produce basin floor deposition over 500-1500 km² with a mass of 10-100 million tons. In submarine canyons and on slopes, this sediment produces turbidity currents and mass-wasting deposits. Century-scale seismic events appear to trigger the largest downslope movement of sediments through slope failure, slides, and slumps in canyon heads along with turbidity currents into the basin (Gorsline 1996).

Within the California borderland basins, fine-grained sediment travels through active levee-channel systems and low relief (1-10 m) distributary channels that extend basinward from major submarine fans. Both gravity processes and nephloid flows carry the sediment. Because the feeder canyons have maintained connections with sediment sources during sea-level rise, the systems are active during the entire sea-level cycle. In the borderland basins, therefore, sediment supply to the basins is not a simple function of eustasy in which canyons cease to provide sediment during periods of high sea level (Schwalbach et al. 1996).

2.4 SUMMARY AND DATA GAPS

Tectonics processes strongly controls the physiography of the Southern Study Area, with the area north of Point Conception displaying a contiguous continental shelf, slope, and abyssal plain and the southern area, from Point Conception to the Mexican border, displaying a fragmented continental shelf consisting of ridges and basins largely related to the development of the San Andreas Fault system. Sediment supply to the deep basins is dominated by decadal and century-scale storm influx from fluvial sources, except in deep basins distal to sediment sources in which laminated sediment is thought to reflect changes in primary productivity of the ocean water, but is not conclusively proven.

Twenty-five percent of the sedimentary organic matter comes from river input; the rest is from primary production in the marine environment. River influx is highest in winter; biogenic primary production is seasonal and increases with spring-summer upwelling. Upwelling and

sediment transport are influenced by the southward moving California Current, one of the currents in the California Current System (CCS) that extends from British Columbia to Baja, California. The south-flowing California Current has diverse regional characteristics, intricate eddy motions, and a major impact on biogeochemical distributions as well as nearshore waves and currents. Larger-scale eddies occur near topographic features and transport materials away from the shelf; wind-driven summer upwelling is typically located south of headlands. Semi-permanent cyclonic gyres and associated spinoff eddies have been documented controlling surface suspended sediment throughout the California borderland, and likely control resulting sedimentation patterns of terrigenous silt and clay and associated organic matter.

The distribution and fate of chemical constituents in continental shelf sediments include mineralization and dissolution of particulate organic matter. The passage of gravity waves and bottom currents over irregular surfaces of the continental shelf can enhance organic mineral crystallization in sandy shelf substrates. In the Monterey Bay area, metal fluxes from sediment are higher in areas with elevated rates of organic carbon remineralization, which occur in upper shelf waters. The flux of metals (manganese, copper, and iron) is lower in deep basin waters associated oxygen minimum zones.

Sediments transported by waves and littoral cell currents are redirected basinward by submarine canyons that may be located relatively near the shore or at the seaward shelf margin. The intracanyon transport mechanisms are dominantly gravity driven and include mass wasting, turbidity currents, and transport as nephloid layers. An earthquake or storm often triggers mass failure. The submarine canyons are unusual in being headed sufficiently close to shore to funnel sediments during both high and low stands of sea level.

Geologic hazards are dominated by earthquake shaking, fault rupture and deformation, mass wasting, and tsunamis. Scouring action by bottom currents, including turbidity currents, are less likely to prove hazardous to hydrocarbon production infrastructure due to the confinement of most turbidity currents to submarine canyons or deep basins.

Data needs for the southern study area include:

- High-resolution bathymetric mapping of offshore features and identification and dating of mass-wasting features;
- Quantification of erosion and sediment-distribution changes related to climate change;
- Temporal changes in fluid and gas expulsion related to leakage of hydrocarbon structures or hydrate disassociation to that the causes can be determined; and
- Determination of the effects of bedform migration on the shallow shelf.

2.5 LIST OF LITERATURE—GEOLOGICAL OCEANOGRAPHY

Alexander, C.R. and H.J. Lee. 2009. Sediment accumulation on the Southern California Bight continental margin during the twentieth century. Lee, H.J. and W.R. Normark. Earth

- sciences in the Urban Ocean: The Southern California Continental Borderland. Geological Society of America Special Paper 454:69-87.
- Best, T.C., and Griggs, G.B. 1994. A sediment budget for the Santa Cruz littoral cell, California. In: Osborne, R.H., ed. From shoreline to abyss. Society of Economic Paleontologists and Mineralogists, Special Publication 46: 35-50.
- Bohannon, R.G. and J.V. Gardner. 2004. Submarine landslides of San Pedro Escarpment, southwest of Long Beach, California. *Marine Geology* 203:261-268.
- Borrero, J.C., J.F. Dolan and C.E. Synolakis. 2001. Tsunamis within the eastern Santa Barbara Channel. *Geophysical Research Letters* 28(4):643-646.
- Borrero, J.C., M.R. Legg and C.E. Synolakis. 2004. Tsunami sources in the Southern California Bight. *Geophysical Research Letters* 31(L-13211):4.
- Covault, J.A., W.R. Normark, B.W. Romans and S.A. Graham. 2007. Highstand fans in the California borderland; The overlooked deep-water depositional systems. *Geology* 35(9):783-786.
- Crouch, J.K. and J. Suppe. 1993. Late Cenozoic tectonic evolution of the Los Angeles basin and inner California borderland: A model for core complex-like crustal extension. *Geological Society of America Bulletin* 105(11):1415-1434.
- Dailey, M.D., D.J. Reish and J.W. Anderson. Eds. 1993. *Ecology of the Southern California Bight: A synthesis and interpretation*. University of California Press.
- Davis, A.S., D.A. Clague and J.B. Paduan. 2007. Diverse origins of xenoliths from seamounts at the continental margin, offshore central California. *Journal of Petrology* 48(5):829-852.
- de Haas, H., T.C.E. Van Weering, and H. De Stieger. 2002. Organic carbon in shelf seas: Sinks or sources, processes and products. *Continental Shelf Research* 22(5):691-717.
- de Lappe, B.W., R.W. Risebrough, and W. Walker II. 1983. A large-volume sampling assembly for the determination of synthetic particulate phases of seawater. *Can. J. Fish. Aquat. Sci.* 40:322–336.
- Dickenson, W.R., M. Ducea, L. Rosenberg, H.G. Greene, S.A. Graham, J.C. Clark, G.E. Weber, S. Kidder, W.G. Ernst and E. Brabb. 2005. Net dextral slip, Neogene San Gregorio-Hosgri Fault Zone, coastal California. Geological Society of America. Special Paper 391:43.
- Edwards, B.D., R.T. Hanson, E.G. Reichard and T.A. Johnson. 2009. Characteristics of Southern California coastal aquifer systems. In: Lee, H.J. and W.R. Normark. *Earth sciences in the Urban Ocean: The Southern California Continental Borderland*. Geological Society of America. Special Paper 454:319-344.

- Edwards, B.D., H.J. Lee and M.E. Field. 1995. Mudflow generated by retrogressive slope failure, Santa Barbara Basin, California Continental Borderland. *Journal of Sedimentary Research* A65:57-68.
- Eichhubl, P., H.G. Greene and N. Maher. 2002. Physiography of an active transpressive margin basin: High-resolution bathymetry of the Santa Barbara Basin, Southern California Continental Borderland. *Marine Geology* 181:95-120.
- Fialko, Y. 2006. Interseismic strain accumulation and the earthquake potential on the southern San Andreas Fault system. *Nature* 441:968-971.
- Fildani, A. and Normark, W.R. 2003. The stratigraphic evolution of Monterey fan area and growth patterns of related channel complexes. *Search and Discovery article # 30017*.
- Fisher, M.A., W.R. Normark, H.G. Greene, H.J. Lee and R.W. Sliter. 2005. Geology and tsunamigenic potential of submarine landslides in the Santa Barbara Channel, Southern California. *Marine Geology* 224:1-22.
- Fisher, M.A., C.C. Sorlien and R.W. Sliter. 2009a. Potential earthquake faults offshore Southern California from the eastern Santa Barbara Channel south to Dana Point. In: Lee, H.J. and W.R. Normark. *Earth Sciences in the Urban Ocean: The Southern California Continental Borderland*. Geological Society of America. Special Paper 454:271-290.
- Fisher, M.A., V.E. Langenheim, C. Nicholson, H.F. Ryan and R.W. Sliter. 2009b. Recent development in understanding the tectonic evolution of the Southern California offshore area: Implications for earthquake-hazard analysis. In: Lee, H.J. and W.R. Normark. *Earth sciences in the Urban Ocean: The Southern California Continental Borderland*. Geological Society of America. Special Paper 454:229-250.
- Gorsline, D.S. 1996. Depositional events in the Santa Monica Basin, California Borderland, over the past five centuries. *Sedimentary Geology* 104(1-4):73-88.
- Greene, H.G., S.H. Clarke and M.P. Kennedy. 1991. Tectonic evolution of submarine canyons along the California continental margin. In: Osborne, R.H.. *From shoreline to abyss*. Society of Economic Paleontologists and Mineralogists. Special Publication 46:291-312.
- Greene, H.G., N.M. Maher and D.K. Paull. 2002. Physiography of the Monterey Bay National Marine Sanctuary and implications about continental margin development. *Marine Geology* 181:55-82.
- Greene, H.G., N. Maher, C.E. Paull, M.A. Fisher, P. Eichhubl, P. Watt , and L. Murai. 2006. Submarine landslides of the Santa Barbara Basin: Potential tsunami generators. *Natural Hazards and Earth System Sciences* 6:63-88.
- Gutmacher, C.E. and W.R. Normark. 1993. Sur submarine landslide, A deep-water sediment slope failure. In: Schwab, W.C., Lee, H.J., and Twichell, D.C., eds. *Submarine landslides:*

- Selected studies in the US Exclusive Economic Zone. U.S. Geological Survey Bulletin 2002. 158-166 pp.
- Gutmacher, C.E. and W.R. Normark. 2002. Sur submarine landslide, a deep-water sediment slope failure. In: Schwab, W.C., H.J. Lee, and D.C. Twichell. Submarine landslides: Selected studies in the U.S. Exclusive Economic Zone. U.S. Geological Survey Bulletin. Pp. 158-166.
- Hagadorn, J.E., L.D. Stott, A. Sinha and M.M. Rincon. 1995. Geochemical and sedimentological variations in inter-annually laminated sediments from Santa Monica Basin. *Marine Geology* 125(1-2):111-131.
- Hanson, R.T., J.A. Izbicki, E.G. Reichard, B.D. Edwards, M. Land, and P. Martin. 2009. Comparison of groundwater flow in Southern California coastal aquifers. In: Lee, H.J. and W.R. Normark. *Earth sciences in the Urban Ocean: The Southern California Continental Borderland*. Geological Society of America Special Paper 454:345-373.
- Hein, F.J. and D.S. Gorsline. 1980. Geotechnical aspects of fine-grained mass flow deposits: California Continental Borderland. *Geo-Marine Letters* 1(1):1-5.
- Hickey, B.M. 1998. Coastal oceanography of western North America from the tip of Baja to Vancouver Island. In: Robinson, A.R. and K.H. Brink. *The sea, the global coastal Ocean: Regional studies and syntheses* vol. 11. New York: Wiley.
- Jennings, C.W. 1992. Preliminary Fault Activity Map of California. California Division of Miens and Geology Geologic Data Map No. 2. Scale 1:750,000.
- Johnson, K.S., W.M. Bruland, K.H. Coale, T.L. Coley, V.A. Elrod, W.R. Fairey, D.D. Iams, T.E. Kilgore and J.L. Cowcki. 1992. Manganese flux from continental margin sediments in a transect through the oxygen minimum. *Science* 257(5074):1241-1245.
- Lee, H.J. and W.R. Normark. 2009. *Earth Sciences in the Urban Ocean: The Southern California Continental Borderland*. Geological Society of America. Special Paper 454: 481 pp.
- Lee, H.J., H.G. Greene, B.D. Edwards, M.A. Fisher and W.R. Normark. 2009. Submarine landslides of the Southern California Borderland. In: Lee, H.J. and W.R. Normark. *Earth sciences in the Urban Ocean: The Southern California Continental Borderland*. Geological Society of America. Special Paper 454:251-269.
- Legg, M.R. 1991. Developments in understanding the tectonic evolution of the California Continental Borderland. In *From shoreline to abyss: Contributions in marine geology in honor of Francis Parker Shepard*. Society of Economic Paleontologists and Mineralogists. Special Publication 46:291-312.
- Marsaglia, K.M., A.S. Davis, K. Rimkus and D.A. Clague. 2006. Evidence of a spreading ridge with the outer California borderland. *Marine Geology* 229:259-272.

- McCulloch, D.S. 1989. Geologic Map of the South-Central California Continental Margin—Map No. 4A (Geology), Sheet 1 of 4, in: California, Continental Margin Geologic Map Series South-Central California Continental Margin Area 4 of 7.
- McCulloch, D.S. and H.G. Greene. 1990. Geologic map of the central California continental margin, Map 5A, Area 5, sheet 1 of 4, Scale 1:250,000. In: Greene, H.G. and M.P. Kennedy. California Dept. of Mines and Geology California Continental Margin Geologic Map Series.
- Monterey Bay Aquarium Research Institute. 2007. Map of seamounts in the California borderland. 18, 2007.
- Normark, W.R., D.J.W. Piper, B.W. Romans, J.A. Covault, P. Dartnell, and R.W. Sliter. 2009. Submarine canyon and fan systems of the California Continental Borderland. In: Lee, H.J. and W.R. Normark. Earth sciences in the Urban Ocean: The Southern California Continental Borderland. Geological Society of America. Special Paper 454:141-168.
- Paull, C.K., W.R. Normark, W. Ussler, III, D.W. Caress, R. Keaten, J. Barry, J. Xu, D. Smith, J.A. Covault and K.L. Maier. 2007. Large wave-shaped bedforms in the axial channel of Monterey submarine channel, Monterey Bay, California Eos Trans. AGU 88(52):Abstract H54B-03.
- Ross, S.L., H.J. Lee, T.E. Parsons, L.A. Beyer, D.M. Boore, J.E. Conrad, B.D. Edwards, M.A. Fisher, A.D. Frankel, E.L. Geist, K.W. Hudnut, S.E. Hough, R.E. Kayen, T.D. Lorenson, N. Luco, P.A. McCrory, M.L. McGann, M. Nathenson, M. Nolan, M.D. Petersen, D.J. Ponti, C.L. Powell, H.F. Ryan, J.C. Tinsley, C.J. Wills, F.L. Wong, and J. Xu. 2008. Comments on potential geologic and seismic hazards affecting proposed liquefied natural gas site in Santa Monica Bay, California: U.S. Geological Survey Open-File Report 2008-1344. 60 pp.
- Ryan, H.E., M.R. Legg, J.E. Conrad, and R.W. Sliter. 2009. Recent faulting in the Gulf of Santa Catalina: San Diego to Dana Point. In: Lee, H.J. and W.R. Normark. Earth sciences in the Urban Ocean: The Southern California Continental Borderland. Geological Society of America. Special Paper 454:291-315.
- Schultz, S.S. and R.E. Wallace. 1997. The San Andreas Fault. USGS General Interest Publication. June 17.
- Schwalbach, J.R., B.D. Edwards, and D.S. Gorsline. 1996. Contemporary channel-levee systems in active borderland basin plains, California Continental Borderland. Sedimentary Geology 104(1-4):53-72.
- Shum, K.T. and B. Sunby. 1995. Organic matter processing in continental shelf sediments: The subtidal pump revisited. Marine Chemistry 53(1-2):81-87.
- Sommerfield, C.K., H.J. Lee and W.R. Normark. 2009. Postglacial sedimentary record of the the Southern California continental shelf and slope, Point Conception to Dana Point. In: Lee, H.J. and W.R. Normark. Earth sciences in the Urban Ocean: The Southern California Continental Borderland. Geological Society of America Special Paper 454:89-115.

- Thornton, S.E., 1981. Suspended sediment transport in surface waters of the California Current off Southern California: 1977-1978 floods. *Geo-Marine Letters* 1:23-28.
- Thunnell, R.C., E. Tappa, and D.M. Anderson. 1995. Sediment fluxes and varve formation in Santa Barbara Basin, offshore California. *Geology (Boulder)* 23(12):1083-1086.
- Vedder, J.G. 1987. Regional geology and petroleum potential of the Southern California borderland. In: Scholl, D.W., A. Grantz, and J.G. Vedder. *Geology and resource potential of the continental margin of western North America and adjacent ocean basins—Beaufort Sea to Baja California*, Earth science series. Circum-Pacific Council for Energy and Mineral Resources. Pp. 403-447.
- Vedder, J.G., J.K. Crouch, and A. Junger. 1987. Geologic map of the outer-Southern California continental margin. In: Greene, H.G. and M.P. Kennedy. *California Department of Mines and Geology California Continental Margin Geologic Map Series, Map 3A, Area 3 of 7, Sheet 1 of 4, Scale 1:250,000.*
- Vedder, J.G., H.G. Greene, S.H. Clarke, and M.P. Kennedy. 1986. Geologic map of the mid-central California continental margin. In: Greene, H.G. and M.P. Kennedy. *California Dept. of Mines and Geology California Continental Margin Geologic Map Series. Calif. Div. of Mines and Geol. Scale 1:250 000.*
- Villaescusa-Celaya, J.A., E.A. Gutierrez-Galindo, and G. Flores-Munoz. 2000. Heavy metals in the fine fraction of coastal sediments from Baja California (Mexico) and California (USA), *Environmental Pollution* 108: 453-462.
- Walls, C.W., T. Rockwell, K. Mueller, Y. Bock, S. Williams, J. Pfanner, J. Dolan, and P. Fang. 1998. Escape tectonics in the Los Angeles metropolitan region and implications for seismic risk. *Nature* 294:356-360.
- Warrick, J.A. and K.L. Farnsworth. 2009. Sources of sediment to the coastal waters of the Southern California Bight. In: Lee, H.J. and W.R. Normark. *Earth sciences in the Urban Ocean: The Southern California Continental Borderland. Geological Society of America Special Paper 454:39-52.*
- Yamamoto, M., M. Yamamuro and Y. Tanaka. 2007. The California Current System during the last 136,000 years: Response to the North Pacific high to precessional forcing. *Quaternary Science Reviews* 26(3-4):405-414.

3. CHEMICAL OCEANOGRAPHY AND GEOCHEMISTRY

The chemical oceanography of the Southern Study Area is representative of a complex and dynamic region. Chemicals found in this region can come from atmospheric deposition (particularly during high-pressure, offshore-wind events), runoff from the land, sediment flux, other water masses, or can be produced in situ in these productive waters. Further, chemicals can originate from natural or anthropogenic sources, including point and nonpoint sources. The fate of chemicals released to these waters can be transport to the North Pacific, deposition in any of numerous sedimentary environments, evasion to the atmosphere, or bioaccumulation, as well as in-situ chemical and biological transformation. The goal of this chapter to update the knowledge base concerning the distribution and fate of chemicals in the Southern Study Area, which was last reported in 1993. That review by Eganhouse and Venkatesan (1993) was comprehensive, incorporating knowledge of chemical distributions and fates to that time. The present work is a focused update, primarily considering the relevant chemical descriptors of human and natural systems that could be impacted by the continued development and operation of existing oil and gas leases in the Southern Study Area of the Outer Continental Shelf (OCS) of the United States, from northern Santa Barbara County to the Mexican border. The term “recent” is used here to distinguish works published after the 1993 Eganhouse and Venkatesan review.

This chapter covers four sections of related topics. The first section considers the sources of organic matter and trace elements in the region, both natural and anthropogenic. The second section updates the knowledge of water column processes that impact the distribution of chemicals in the region, with an emphasis on the dynamics of natural systems. The third section considers the distribution and fate of chemical constituents including organic matter and trace metals. The fourth section covers the input of petroleum to the region through natural seepage, a process prevalent in much of the planning area.

3.1 SOURCES OF ORGANIC MATTER AND TRACE ELEMENTS

Chemicals found in the study region arise from numerous sources. Autochthonous sources are driven by primary production, which is often prolific in the upwelling regime of the California Current System. Allochthonous sources of chemicals include transport by currents into the study area, atmospheric deposition to the sea surface, release from underlying sediments or bedrock, and flux from land.

3.1.1 Autochthonous Sources

Autochthonous sources of chemicals to the study region are those formed in situ, with the primary emphasis here on organic compounds produced through primary production coupled to photosynthesis in the surface waters. Autochthonous organic matter in marine settings is generally characterized in two classes, dissolved organic carbon (DOC) and particulate organic carbon (POC), the distinction being empirical rather than chemical; that is, the categorization is determined by the effective pore size used to filter particulate matter from the water. Commonly, the more general terms, dissolved organic material (DOM) and particulate organic material (POM), are used to describe dissolved molecules and particulates, respectively, containing carbon and other elements such as nitrogen, sulfur, or phosphorus.

A variety of recent investigations have considered autochthonous organic matter in the Southern Study Area. Several studies of the sedimentary record provide important background on the historical input of allochthonous carbon sources. Foremost among these studies are two full volumes of the *Proceedings of the Ocean Drilling Program* (Ocean Drilling Program et al. 1993; Ocean Drilling and Rose 2000), which describes eight drilled sites in this region during leg 167, and one highly prolific site in the Santa Barbara Basin during leg 146 (note that the full text of these volumes is not in the database accompanying this report but is available online free of charge through the Ocean Drilling Program website: <http://www-odp.tamu.edu/publications/>). The cores vary in age, arguably the most useful being the high-resolution core from the rapidly sedimenting Santa Barbara Basin, site 893. This core provided better than decadal resolution of changes in sediment deposition and changes to the overlying water productivity and temperature for approximately the past 160,000 years. This core also provided evidence for variations in the prevalence of anoxia in the Santa Barbara Basin, and for shifts in the input of marine versus terrigenous carbon sources.

Numerous recent studies have considered active autochthonous carbon input into the study region, though often indirectly. Many such studies are enabled by larger research efforts, including the quarterly cruises of the California Cooperative Ocean Fisheries Initiative (CalCOFI), the real time data provided by the Southern California Ocean Observing System (SCOOS), and primary productivity as quantified by satellite. The modern export of particulate organic carbon from surface waters has been reported from sediment traps from the Santa Barbara Basin (Thunell 1998; Thunell et al. 2007) and San Pedro Basin (Thunell et al. 1994a; Thunell et al. 1994b), with the conclusion that there are seasonal variations in the proportion of autochthonous and allochthonous material, as well as an enhanced input of terrigenous material during the winter months. The composition of particulate carbon has been analyzed for the Santa Barbara Basin (Jones et al. 2008; Roland et al. 2008; Li et al. In press) and Santa Monica Basin (Gong and Hollander 1999; Pearson and Eglinton 2000; Pearson et al. 2001; Jones et al. 2008), with numerous inputs distinguished by compositional and isotopic (^{13}C , ^{14}C , ^2H) measurements. Importantly, these studies are able to distinguish certain petroleum inputs from natural products such as leaf wax.

While most sources of autochthonous organic material have little direct environmental impact, some contain certain chemicals, such as domoic acid produced by *Pseudo-nitzschia*, that are harmful to marine life. For example, domoic acid was implicated in more than 1,400 strandings of marine mammals in the study region from 2003 to 2004 (Schnetzer et al. 2007). Such blooms are common in the study region, and scientific investigations have focused on various coastal areas including San Pedro Channel, Los Angeles Harbor (Schnetzer et al. 2007), Santa Barbara Channel (Anderson et al. 2008), and Santa Monica Bay (Shipe et al. 2008). Concentrations of particulate domoic acid as high as 17 $\mu\text{g/L}$ have been reported in this region, with measurable concentrations found in sediment traps to depths of 800 m only one week after a major bloom. Blooms of *Pseudo-nitzschia* in this region derive from nutrient inputs generally caused by upwelling events.

Climatic events strongly impact primary productivity, which in turn affects the sources and distribution of autochthonous organic material in the study region. The El Niño/La Niña events provide one such example (Lynn et al. 1998). Changes in ocean circulation and resulting changes in regional surface water temperature and upwelling strongly impact primary production (Lynn et al. 1998). During the 1997-1998 El Niño event for example, the presence of a warm water mass in the Santa Barbara Basin depressed the thermocline, reduced upwelling, and thus reduced primary production. Interestingly, (Shipe et al. 2002) reported an increase in export flux of POC to the deep waters of the basin, likely caused by enhanced terrigenous inputs associated with elevated river runoff. The monitoring of primary production by satellite through the 1997-98 El Niño indicated that the primary factor controlling bloom events was upwelling associated with wind events, thus the effects of the El Niño/La Niña cycle were modulated by changes in nutrient levels associated with current flow (Otero and Siegel 2004). Overall, this event yielded the lowest average concentration of zooplankton in the study region as measured over 50 years of CalCOFI cruises (Lynn et al. 1998).

3.1.2 Allochthonous Sources

Allochthonous compounds found in the study area include both organic and inorganic compounds and originate from a variety of sources including natural terrestrial and sediment sources as well as anthropogenic inputs from numerous sources.

3.1.2.1 Organic Compounds

With a current population in Southern California of around 17 million, significant levels of municipal wastewater are generated and released to the Southern California Bight. This region's largest origination point sources for sewage waste are the four large municipal wastewater treatment facilities: Hyperion Treatment Plant, Joint Water Pollution Control Plant, Orange County Sanitation District, and Point Loma Wastewater Treatment Plant. Collectively these plants released 1.45×10^{12} liters of effluent to the Southern California Shelf in 2004 (Lyon et al. 2006). While the volume of effluent discharged has remained consistent (± 15 percent) since 1982, the contaminant load has decreased substantially in these waters for many organic components, including suspended solids, oil and grease, organic nitrogen, DDT, and polychlorinated biphenyls (PCB). In addition to the four major treatment plants releasing to the Southern California Shelf, an additional 19 publicly owned treatment works (POTWs) also released wastewater to this region (Lyon and Stein 2008). These POTWs are distributed throughout the region: five located in Santa Barbara County, one in Ventura County, one in Los Angeles County, two in Orange County, seven in San Diego County, one on Catalina Island, and one on San Clemente Island. Collectively these 19 facilities released about 17 percent as much effluent volume in 2005 as the four large municipal facilities did for 2004 (for when data were readily available). The overall release of organic material from all treatment facilities has consistently decreased since the early 1980s concurrent with the expansion of secondary and tertiary treatment techniques.

In the arid climate of Southern California, significant rains are generally limited to the late fall, winter, and early spring, with often lengthy dry intervals. As a result, pollutants tend to accumulate at the land surface and are rapidly flushed from the watershed (Lyon et al. 2006) during heavy rain events (Ackerman and Schiff 2003; Ahn et al. 2005). Stormwater discharge

from rivers in the region creates turbid plumes that can extend offshore for several kilometers (Washburn et al. 2003) and carry chemical and bacterial contamination. An analysis of stormwater pollutant loading by land use type for this region (Stein et al. 2008) demonstrated that pollutants such as polycyclic aromatic hydrocarbons (PAH) are flushed from the watershed during the rising limb of the hydrograph, often being flushed from a given watershed within hours after rains begin. The distances and transport times must be superimposed on the first flush of pollutants from individual watersheds to effectively model or predict the runoff entering the coastal ocean. Interestingly, the dominant source of PAH to stormwater in this region is pyrogenic, resulting from combustion of fossil fuels, which is likely deposited to the land through dry atmospheric deposition. Satellite imagery is also now being applied to investigate the impacts of stormwater and other wastewater pulses. For example, synthetic aperture radar aboard satellites has been used to track stormwater pulses as well as wastewater plumes and oil seeps (DiGiacomo et al. 2004). These events smooth small wave and capillary action and reduce radar backscatter relative to the surrounding ocean. Other active satellite sensors that have also been successfully used to track stormwater plumes in the study area include MODIS (Nezlin et al. 2008) and SeaWiFS (Nezlin et al. 2005). Satellite-based measurements were also used to assess the occurrence, extent, and duration of sediment plumes from stormwater, and the conclusion was that such plumes are a winter phenomenon that is dramatically accentuated during El Niño years (Otero and Siegel 2004).

Natural petroleum seepage, considered in greater detail in [section 3.4](#), also provides a significant input of hydrocarbons and tar to the Southern California planning area. Seepage is so pervasive in this region that chemical components of petroleum are nearly ubiquitous in offshore sediment samples (Ocean Drilling and Rose 2000; Hill et al. 2006; Farwell et al. 2009). The majority of seepage appears to occur in the vicinity of the Santa Barbara Basin, with additional seep areas associated with the Santa Maria and Santa Monica Basins. Oil seepage seemingly occurs more along continental shelves (Peters et al. 2008), while gas seepage occurs both along the shelves and in deeper locations within the Santa Barbara, Santa Monica, and Santa Maria Basins. However, evidence to date suggests that seeps located in deep waters in this region are supplied by biogenic gas, as evidenced by depleted $\delta^{13}\text{C-CH}_4$ and low concentrations of higher hydrocarbons. In contrast, seeps located along the continental shelves seem to be sourced from thermogenic reservoirs, with a depth of approximately 200 m, serving to distinguish the biogenic versus thermogenic seeps. Though accurate quantification is not available for the total petroleum input to the region, one recent study estimated that there were 0.31 to 3.1 Tg of oil trapped in shelf sediments in the roughly 90 km² region due west of Coal Oil Point (Farwell et al. 2009).

The core from Ocean Drilling Program ODP 893 (Ocean Drilling Program et al. 1993; Hinrichs et al. 2003) in conjunction with other cores from the Santa Barbara Basin (Hill et al. 2006) and the core from ODP site 1016 off Arguello Canyon provide evidence for the long-term input of methane and oil to this region. Strong evidence from these cores suggests active marine petroleum seepage in this region dating to well over 100,000 years ago, with the primary source of seep oil being from the Monterey Formation, as it remains today (Hill et al. 2006; Farwell et al. 2009). While flux appears to vary, (Ocean Drilling Program et al. 1993; Hinrichs et al. 2003; Hill et al. 2006) there appears to be consistent oil input. Evidence from a near-shore subaerial

fault bounding the Santa Barbara Basin indicates petroleum seepage dating to approximately 400,000 years ago (Boles et al. 2004), and older seepage would not be surprising.

The patterns of methane input to the Southern California planning area are complex and suggest four major modes of input: (1) seeps, sediments, and runoff along the continental shelves; (2) seeps located at approximately 200 m water depth in the region of the Santa Barbara Basin; (3) in-situ production at the base of the euphotic zone; and (4) sediments of the deep basins. Previously identified gas seeps along the continental shelf are prolific in selected areas such as the northern shore of the Santa Barbara Channel and are also known off Santa Monica and Point Arguello. Other sources that may also contribute to methane in near-shore waters include diffusive escape from sediments and in terrestrial runoff such as wastewater outflows. However, the dynamics and variable methane concentrations of the coastal zone, coupled with uncertainty in seepage and sediment sources in this zone, render differentiation of sources difficult. Evidence from a time series of methane sampling in the Santa Barbara and Santa Monica Basins indicates a persistent elevation in methane in the depth range of approximately 200 to 250 m (Kessler et al. 2008). The source of elevated methane remains unclear, though gas seepage seems likely. Studies of methane dynamics in waters from 0 to 300 m deep beyond the interior basins of the Southern Study Area suggest in-situ production of methane in this layer. Such methane production may be masked inshore by an elevated background or may not occur because of upwelling conditions. Elevated levels of methane are also found in several of the near-shore basins, particularly in the benthic boundary layer, and are likely caused by diffusive methane loss from sediments.

Another important source of allochthonous carbon to the study region comes from anthropogenic activities other than wastewater and stormwater runoff. Such activities include chemicals from harbors, dumping activities, dredging, vessel traffic, military activities, and industrial activities including oil production. Some information about such carbon sources is available in the peer-review literature, though much has not been reported on. Information about offshore industrial activity is often detailed in environmental impact statements and reports to agencies such as the BOEMRE. Other studies, such as the impact of military activity on chemical distributions, are not generally available. In a general sense, organic chemical inputs from vessels and industrial activity include release of oil, grease, antifouling agents, and sewage to the water, and potential spills or releases of other organic compounds such as lubricants or petrochemicals. For example, antifouling agents such as organotins used on large vessels have been identified in the sediments of the Santa Monica and San Pedro Basins (Venkatesan et al. 1998). Combustion products from exhaust are also released, and typically include volatile organic carbon (VOC). Note that offshore oil production releases two important greenhouse gases, carbon dioxide and methane, which may become regulated in the future. Accurate quantification of releases for these compounds is not readily available in the scientific literature, though it may be tracked by the offshore producers. Dumping of industrial chemicals in the study area is now generally forbidden, but extensive dumping of petrochemical wastes was conducted for decades with little or no regulation or oversight. One example is industrial wastes associated with production of DDT, which was freely released through wastewater at the rate of approximately 300 to 600 kg per day through the 1950s, '60s, and '70s, later replaced by at-sea dumping in the Santa Monica and San Pedro Basins. Additional sources of non-peer-reviewed information, besides those in

reports by organizations such as BOEMRE and the Southern California Coastal Water Research Project (SCCWRP), include conference proceedings such as those from the California and the World Ocean Conference.

3.1.2.2 Inorganic Compounds

In addition to organic material, numerous inorganic compounds also enter into the study region. Three general classes are considered here: nutrients, trace metals, and sulfur compounds.

3.1.2.2.1 Nutrients

Primary nutrients for the study region are nitrate (NO_3^-), phosphate (PO_4^{3-}), silica (dissolved Si), and iron (Fe(III)). The main source of these nutrients to surface waters is upwelling that characterizes much of the California Current System in the study area. In addition, sediments and terrestrial sources supply nutrients through sediment diagenesis, natural and anthropogenic runoff, and possibly aeolian transport. While this topic was reviewed by (Eganhouse and Venkatesan 1993), several new works contribute further knowledge as to the sources and importance of nitrate, silica, and iron to the study area.

Most nitrogenous nutrients in the study region originate from upwelling. While nitrate is typically considered to be the most important form of nitrogen feeding primary production, research conducted in the study area also implicates dissolved organic nitrogen (DON) as a major source of nitrogen feeding or sustaining primary production (Ward and Bronk 2001; Bronk and Ward 2005; Bronk et al. 2007). Organic forms of nitrogen are typically thought to be utilized by bacteria, and the discovery of their direct utilization by primary producers, including some harmful algae (Bronk et al. 2007), represents a departure from classical thinking about nutrient sources for marine primary producers. Nitrate from upwelling is typically used by phytoplankton and enables blooms, including blooms of toxic species such as *Pseudo-nitzschia* (Schnetzer et al. 2007; Anderson et al. 2008; Shipe et al. 2008). Nitrate may also originate from coastal runoff in the study region, though it is likely equivalent to only a fraction of the upwelled nitrogen (Otero and Siegel 2004; Warrick et al. 2004; Warrick et al. 2005).

The importance of Fe(III) as a nutrient in the study area has also received some attention since the last update by (Eganhouse and Venkatesan 1993). Iron is seemingly limited in primary production in the study region because most upwelling occurs in the offshore environment away from the narrow continental shelf where iron is readily introduced from sediments (Bruland et al. 2001). Nutrients such as nitrate and silicic acid remain unused because of the iron limitation; thus the upwelling waters in the study region can be defined as high-nutrient-low-chlorophyll (HNLC) waters. Manipulation experiments have confirmed that iron addition can stimulate primary production in the HNLC waters off Southern California (King and Barbeau 2007).

Dissolved silicon, typically in the form of silicic acid, is an important nutrient in the waters of the study region because it is utilized by some phytoplankton and higher trophic level organisms to form their shells. Several studies have investigated dissolved silicon since the last update. A comprehensive 5-year study of the silica cycle in the Santa Barbara Basin (Shipe and Brzezinski 2001) estimated biogenic silica production rates to be as high as $5.5 \text{ mol/m}^2/\text{yr}$, which is similar to rates in the world's major upwelling regions. A high fraction of this silica, 30 percent, was

exported to a depth of 470 m, which is a greater preservation than in other regions. The flux of particulate silica in this region also typically corresponds with climatic events, with changes in local current patterns identified as one linking factor (Venrick et al. 2006). Silica availability has also been linked with toxic algal blooms in the study region, with silicon-limitation observed in one bloom in the Santa Barbara Channel (Anderson et al. 2008), and excess silicon observed in other blooms in Santa Monica Bay (Shipe et al. 2008). Silica fluxes from sediments at depths of 400-900 m have also been quantified in the study area, and were shown to supply 0.1 to 1.2 mol Si/m²/yr to the water column.

3.1.2.2.2 Dissolved Oxygen

Dissolved oxygen in seawater is derived from two sources: gas exchange with the atmosphere when the water mass is at the surface; and the in situ balance between generation of oxygen from autotrophs during the day, and consumption of oxygen through respiration by heterotrophs (day and night), and autotrophs (at night). Within the California Current System, the California Current brings cooler, fresher, oxygen-rich subarctic water southward, while the California Undercurrent brings warmer, saltier, low-oxygen subtropical water northward (Bray et al. 1999). Surface waters with high productivity have supersaturated oxygen levels (Nezlin et al. 2004) this occurs in upwelling regions where productivity in newly upwelled water increases oxygen levels to the saturation or supersaturation point. Within the oxygen minimum layer off California, generally between 400-1000 m, partial pressure of oxygen is $PO_2 = 0.8$ kPa (Childress and Seibel 1998). Periodic shoaling of warm, nutrient rich, but low oxygen water during El Niño winters may enrich surface productivity and thus oxygen levels (Ladah 2003). Along the bottom, the oxygen levels in the deep basins decrease from south to north, with some nearly anoxic (see section 2.6 Basin Water Renewal).

Bograd (2001) used 55 quarterly CalCOFI cruises from 1984-1997 to constrain a box model of the upper 500 m of the water column between CalCOFI line 77 and line 93, which includes the Southern California Bight and waters offshore. The mean flux of oxygen transported out of the box by local currents is ~380 mL O₂/m²/d, while the oxygen production within the box from nitrate flux is ~1000 mL O₂/m²/d. The difference between these fluxes is the amount of oxygen lost to the atmosphere or locally consumed without producing nitrate. During spring, oxygen fluxes are higher, most likely because the higher wind velocities lead to higher gas transfer velocities.

3.1.2.2.3 Particulate Material

Particulate material has three major sources: riverine discharge, resuspension of bottom material, and growth and excretion from surface activity through the food chain. Within the California Current System, the California Current brings cooler, fresher, low-transparency subarctic water southward, while the California Undercurrent brings warmer, saltier, higher transparency subtropical water northward (Nezlin et al. 2004). Years with higher upwelling also have higher oxygen supersaturation and higher turbidity. Sediment trap experiments in the San Pedro Basin indicate temporal variability in sedimentary fluxes ([discussed above in 3.1.1](#)) with lithogenic fluxes higher in winter during periods of higher rainfall, and biogenic fluxes higher in early spring and early summer due to the onset and second phases of upwelling (Thunell et al. 1994b).

Hales et al. (2006) described a simple model relating the changes in particulate material distribution to the upwelling regime. Though the research was done off the coast of Oregon, the concepts should be applicable to the Southern Study Area, particularly to the shelf near the Monica Basin. During upwelling conditions the high phytoplankton growth at the surface develops organic particles which are carried off into deep water by the offshore flow. The bottom benthic layer is stirred up by the turbulent benthic boundary layer and some of the material supplies nutrients that contribute to the high productivity observed ([see Section 3.1.2.2.1](#) on Nutrients). During relaxation conditions, the surface productivity is much reduced and contained inshore where particulate material is deposited in shallow water. During relaxation the benthic boundary layer moves any suspended particulate matter offshore and into deep water.

Along the bottom, the deep basins turbidity increases from south to north ([see section 1.6 Basin Water Renewal](#)). Sources of turbidity include zooplankton fecal matter, sinking phytoplankton blooms, and aggregate particles, referred to as “marine snow.” The contribution of each of these components to the turbidity varies with many factors including productivity, biomass, trophic interactions, particle size, and seasonal and yearly trends (Turner 2002). In the water column, the fecal pellets of zooplankton and fish sink while smaller fecal pellets are recycled before reaching the sea floor. “Marine snow” is made up of many components including sinking phytoplankton blooms and fecal matter bound together by microbial communities (Alldredge and Silver 1988). Recent literature reports that the composition of particles reaching the sea floor contains a substantial proportion of “marine snow” and that these aggregate particles are of significant importance to the sedimentary flux (Turner 2002). The benthic response to and consumption of these seasonal influxes of sinking phytoplankton booms may have masked evidence of this flux in earlier studies.

3.1.2.2.4 Trace Metals

The distribution and reactivity of trace metals in the ocean is an ongoing and active area of research that has seen significant changes since the previous update. For example, it is now established that the dissolution and bioavailability of several metals is dependent on organic ligands that bind the metals in sea water. It is also now understood that many trace metals have important biological roles and can, in some cases, replace other metals. That is, many trace metals are now known to be beneficial to marine ecosystems at low concentrations in addition to being toxic at elevated levels. In this section we focus on a select number of trace metals for which information is available for the study area. Many studies consider a group of many metals together, though the suite of metals considered is different among the studies.

The input of trace metals to the study region from terrestrial sources is known to cause environmental problems. The flux of trace metals released through wastewater is monitored and has generally decreased in recent times. However, these metals, including silver (Ag), aluminum (Al), cadmium (Cd), chromium (Cr), copper (Cu), manganese (Mn), nickel (Ni), lead (Pb), and zinc (Zn), have been deposited into shelf sediments and are subject to mobilization, such as through resuspension of silt particles to which metals are adsorbed, as occurs along the Palos Verdes shelf (Santschi et al. 2001). Other outfalls also lead to elevated trace metal concentrations in the surrounding sediment, such as at Punta Bandera near the United States-Mexico border, which seemingly (Villaescusa-Celaya et al. 2000) has caused local sediment

accumulation of Cr, Zn, Ni, and Cu. Metals from wastewater also impact deep sediments, such as those in the Santa Monica and San Pedro Basins. The deep sediments in these basins have accumulated 3 to 12 percent of the wastewater release of the anthropogenic metals Cr, Zn, Pb, Cu, Ag, and Cd, with much of the remainder presumably being transported further offshore (Huh 1996). The flux of trace metals from runoff is potentially more problematic. For example, a 3-year study of the dispersion of stormwater plumes from two watersheds (Ballona Creek and Malibu Creek) into Santa Monica Bay found that Ballona Creek, which drains an urbanized area, exhibits toxicity whenever the mixing ratio of stormwater exceeds 10 percent (Bay et al. 2003). The toxicity, measured by sea urchin fertilization, was attributed to zinc in the stormwater. Harbors and bays further act as a source of trace metals deposited to the coastal ocean, with contaminated sediments and vessels presumably the major source (Schiff et al. 2004; Schiff et al. 2007). For example, a real-time survey of Cu, Mn, Ni, Cd, and Zn in San Diego Bay demonstrated significantly elevated levels of these metals in the waters of the bay, compared with those offshore (Esser and Volpe 2002; Volpe and Esser 2002). These metals were also found to be flushed into the coastal ocean through tidal action.

One metal of particular interest for this work is barium, which is abundant in drilling muds and produced waters. Barium is relatively insoluble in ocean water because it forms barite, a sulfate salt. However, in anoxic environments in which sulfate has become depleted, barium is soluble; thus produced waters frequently contain abundant barium. Sources of barium in the study region include anoxic sediments (McManus et al. 1994), seep environments (Torres et al. 2002; McQuay et al. 2008), and anthropogenic activity. Barium is often released during drilling operations from unrecovered drilling muds along with core cuttings, and it has also been found at elevated concentrations in the 4H shell mounds in the Santa Barbara Channel—a site of abandoned oil platforms.

3.1.2.2.5 Sulfur Compounds

Chemically-reduced sulfurous compounds are abundant in seawater because of its high sulfate concentration (approximately 28.9 mM). While most sulfur remains in the fully oxidized form, a variety of reduced sulfur species are also formed. These include organosulfur compounds associated with organisms, including the amino acid cysteine, dimethyl sulfoxide, and related compounds photochemically cycled in the surface waters, and chemically reduced forms of sulfur such as elemental sulfur, polysulfides, and hydrogen bisulfide cycled by microbes in the sediments and at the sea floor. Hydrogen sulfide is commonly associated with biodegraded oil reservoirs and is a major safety concern on oil platforms. Numerous studies have considered the distribution of reduced sulfur species in sediments (Reimers et al. 1996; Kuwabara et al. 1999; Berelson et al. 2005; McManus et al. 2006; Li et al. In press), as well as the biological oxidation of reduced sulfur in benthic microbial mat systems (Kalanetra et al. 2004; Ding and Valentine 2008). However, few studies have considered large-scale releases of reduced sulfur in the study region. There is reason to consider the fate of sulfide in the study area, given that a major upwelling area off the coast of Namibia hosts massive sulfide eruptions that impact water quality and are visible from space (Weeks et al. 2004). It is not known whether similar processes occur in the study area under scenarios of changing ocean currents and temperatures, though it is well established that the intermediate waters in the study area are perennially oxygen depleted (Helly and Levin 2004).

3.2 WATER COLUMN PROCESSES – NATURAL SYSTEM DYNAMICS

The processes in the Southern Study Area that manipulate chemical distributions within the water column can be characterized as being physical, biological or chemical. Physical processes include wind, currents, upwelling and oscillating gravity waves within the water column. Biological forces include primary production, respiration and consumption. Chemical forces include scavenging by particle settling, photochemistry (the interaction of chemicals with light), and oxidation-reduction phase changes.

The predominant physical process in the study area is the California Current System. The California Current System in much of the study area is characterized by various levels of upwelling. Periodically, upwelling can be hindered by El Niño/La Niña events. Changes in ocean circulation result in changes in regional surface water temperature, and the weak or non-existent upwelling conditions strongly impact primary production (Lynn et al. 1998). During an El Niño event, nitrate concentrations in surface waters can fall to less than 20 percent of normal and new production can be reduced by close to 70 percent. The reduction in coastal California primary productivity associated with El Niño has been estimated to be 50 million metric tons of carbon (Chavez et al. 2002).

The biologic process of primary production is often prolific in the upwelling regime of the California Current System. An understanding of this process influences the ability to predict the contribution of phytoplankton to carbon cycling, the development and persistence of harmful algal blooms, and the ability to use remote sensing to identify specific phytoplankton taxa which is important for biogeochemistry. The annual cycle is characterized by a transition from a diverse phytoplankton assemblage to a homogenous assemblage dominated by either diatoms, dinoflagellates, or a combination of nano- and pico-phytoplankton (Anderson et al. 2008). Spring diatom (a species of phytoplankton) blooms have led to significant marine mammal deaths in the Santa Barbara Channel in 2003 (Anderson et al. 2008).

The chemical processes of the Southern California Bight are photochemistry, oxidation-reduction and particle scavenging. These processes are perhaps not as well understood as the physical processes and are often studied in the context of biological processes. Recent research on iron-to-ligand photochemistry indicates that it may be an important mechanism for the production of reduced, biologically available iron in surface waters (Barbeau 2006).

3.3 DISTRIBUTION AND FATE OF CHEMICAL CONSTITUENTS

This section describes the distribution and fate of organic and inorganic components introduced into the water column (and ultimately deposited in sediments) in the study area.

3.3.1 Organic Matter

The fate of organic chemicals in the marine environment of the Southern California Bight (SCB) depends to a large extent on the source and point of their introduction into the water column. The physical state of the organic material (dissolved vs. particulate) is also important. The chemical cycling of organic matter in the SCB was covered in depth in the 1993 MMS review (Dailey et al. 1993), and that reference should serve as the basis for estimating overall mass

loadings and carbon budgets. Only papers providing new or updated information published since 1993 are considered in depth in the sections that follow.

Particulate- and dissolved-phase autochthonous (marine) sources include primary production from phytoplankton (and zooplankton), as well as oil introduced from submarine oil seeps. There are approximately 60 seep zones in the 2,600 square kilometers of the Southern California Bight between Point Conception and Long Beach, and they are considered in more detail in [section 3.4](#). It is estimated that two-thirds of the primary production is recycled in the euphotic zone, and the remaining third settles out of the euphotic zone as aggregates of fecal pellets. These processes were covered in depth by Dailey et al. (1993).

Particulate-phase and dissolved-phase allochthonous (terrestrial) sources include domestic and industrial waste discharges, surface runoff from rivers and urban storm drains, dry and wet atmospheric fallout, ocean dumping, and eroded shales from coastal areas. The 1975-1978 Bureau of Land Management (BLM) Southern California Bight studies indicated that most of the metal and hydrocarbon contaminants in the four basins examined (Santa Barbara Channel and San Pedro, Santa Monica, and San Nicolas Basins) were derived from industrial and municipal wastes entering the marine environment through direct discharge, indirect runoff, and atmospheric transport primarily centered in the Los Angeles metropolitan area (Dailey et al. 1993).

With regard to atmospheric input, which is more diffuse than input from the point sources considered below, most of the volatile and particulate-bound organic matter is subject to recycling after deposition into the upper part of the water column, while more refractory compounds (e.g., some pesticides, PCBs, and other chlorinated organics, as well as higher-molecular-weight PAH and metals) can survive to be transported to benthic sediments. These topics have been adequately covered in previous reviews and other MMS/BOEMRE documents (Dailey et al. 1993; USDO, MMS 2001). In general, the sediments of the basins farther from the mainland have higher concentrations of combustion-derived PAH (from aeolian transport), while the basins closer to shore contain PAH from both combustion and petrochemical (natural seep and anthropogenic) sources. Combustion-derived PAH usually encompasses the four- and five-ring components with no alkyl substitution, while petrochemical PAH have relatively higher distributions of two-, three-, and four-ring PAH with higher degrees of alkyl substitution (Wang and Stout 2007). Another diffuse source of offshore contaminants includes shipping (bilge tank cleaning and treated sewage), recreational boating (oil, diesel, and general garbage), and oil and gas facilities (albeit under the limitations of NPDES permits).

As summarized by Daily et al. (1993), regulated pollution sources include treated sewage outfalls and heated water discharges from power plants (containing chlorine to reduce biofouling). Nonregulated sources include storm drains, rivers, and other nonpoint source runoff. Pollutants from these sources include chemicals (pesticides and manufacturing wastes), oil and rubber from vehicles, general trash and garbage, and other materials. In addition, agriculturally based materials from rural areas include animal wastes, pesticides and herbicides, and contaminated soil washed into nearby streams and rivers (Dailey et al. 1993; USDO, MMS 2001).

The fate of shore-based pollutants released through river discharges, storm drains, and nonpoint sources can include uptake by intertidal organisms such as mussels and other bivalves and/or deposition in nearshore sediments. Contaminants in these zones have been examined as part of the National Oceanic and Atmospheric Administration (NOAA) National Status and Trends Program (Mussel Watch) since 1986. That project analyzes chemical and biological contaminant trends in bivalve tissue and sediment samples collected at over 280 sites (9 in the SCB), and the database includes chemistry data for over 140 organic and inorganic contaminants, bivalve histology, and *Clostridium perfringens*. The most recent (2004-2005) data from that program indicate that levels of pollutants are generally decreasing along the Southern California coastline, although concentrations of certain organic contaminants (e.g., tributyltin (TBT) and DDT) are still high where there has been historic use or production and in more urbanized areas (Kimbrough et al. 2008).

Jones et al.(2007) completed a recent multi-institution investigation of the river plumes across eight major river systems of Southern California. They used in-situ water samples from multi-day cruises in combination with MODIS satellite sensing, meteorological observations, drifters, and HF radar current measurements to evaluate the dispersal patterns and dynamics of the freshwater plumes. River discharge was exceptionally episodic, and the majority of storm input occurred in a few hours. River plumes commonly detached from the coast and turned left, which was the opposite direction of Coriolis influence. Although initial offshore velocity of the buoyant plumes was upwards of approximately 50 cm/s and influenced by river discharge inertia and buoyancy, subsequent advection of the plumes was largely in an along-shore direction and was dominated by local winds. Due to the multiple day upwelling wind conditions that commonly follow storm discharge events, plumes were observed to flow from their respective river mouths to downcoast waters at rates of approximately 20 to 40 km/d.

Effluents from sewage treatment plants discharged at depth further from the shoreline introduce both particulate- and dissolved-phase organic components. In addition to the extensive discussions of this phenomenon in the reviews cited above, the fates of these materials have been the subject of several more recent publications. Jones et al. (2002) examined the temporal and spatial variability of physical processes and suspended particulate material over the continental shelf of the Palos Verdes Peninsula during the late summer of 1992 and winter of 1992-1993. The influence of water-column stratification on the distribution of suspended particulate loads was examined, and the contributions from four particulate groups (phytoplankton, resuspended sediments, particles in treated sewage effluent, and terrigenous particles introduced through runoff) were identified. Terrigenous, suspended particulate material sinks from the water column in less than 9 days, and phytoplankton respond to the stormwater input of buoyancy and nutrients within the same time period. The suspended particles near the bottom had spatially patchy distributions, but they were always present in the hydrographic surveys of the shelf. They did not show significant tidal response but may have been maintained in suspension by internal wave and tidal processes impinging on the shelf.

Jones et al. (2008) reported on the molecular and hydrogen isotopic compositions of fatty acids extracted from suspended particulate organic matter (POM) and surface sediments from three

stations on the Southern California Bight: Santa Barbara Basin, Santa Monica Basin, and the Gulf of Santa Catalina. The delta D values for individual fatty acids showed significant deuterium enrichment in both POM and surface sediments. The origins of that enrichment were uncertain: they could reflect either an anomalous D/H fractionation in certain marine bacteria, or a significant terrestrial source for those fatty acids, or both. Surfaced mixed layer and sedimentary even-carbon-numbered fatty acids became slightly deuterium enriched as chain length increased, similar to that observed in living organisms. Presumably, this reflects their biosynthetic origin. However, conflicting results were observed with all POM samples from below the mixed layer, where there was a consistent pattern of deuterium depletion with increasing chain length. The order of deuterium enrichment in the fatty acids was well correlated with their solubility, and may have been caused by fractionations accompanying dissolution or degradation by microbes.

Nepheloid layers in the waters of the Southern California Bight have been reported in certain circumstances to be as much as 5 to 35 m in thickness above the sea floor (Gorsline et al. 1984; Kolpak and Drake 1985). Tightly associated currents and input from shelf turbidity flows were generally responsible for these layers. In addition to suspended particulate organic material loadings from sewage discharges and turbidity flows, fine-grained particulates associated with drilling fluid discharges might also contribute to the phenomena (considered under impacts in [Section 17.5.2](#)). Resuspension processes might also occur from anchoring activities where resuspended sediments drift down current for some distance and eventually settle. The distance for disturbed sediments settling after anchoring activities is dependent on the sediment grain size, bottom current speeds, and bottom type (Lissner et al. 1991). If the sediment includes large percentages of silt, clouds of resuspended sediment can rise in the water column; however, only transient impacts to water quality are expected either vertically or horizontally because these silty sediments will likely settle back to the bottom within 500 m, and they will not rise high enough vertically in the water column to affect background sediment levels (normally 1 to 5 mg/L) over a very large area (Science Applications International Corporation (SAIC) 1986; Lissner et al. 1995). Also, drilling mud that settles close to the discharge point may be resuspended by bottom currents and dispersed down current. Turbidity issues affecting water quality from offshore oil and gas resource development were discussed in MMS (2001), and potential impacting agents, potential water quality parameters affected, and the estimated distance from the point of discharge were summarized. Increases in turbidity from anchoring activities were estimated to range from 100 to 500 m, and impacts associated with the discharge of drilling muds were estimated to possibly extend out to 7,000 m due to fine particulate material. Increases in metal and other contaminants associated with drilling muds and cuttings were estimated to extend up to 1,000 m from the point of discharge.

When organic components associated with these suspended particulate materials (from all sources) eventually settle to the bottom, the degradation of the organic matter is controlled by bacterially mediated processes with different terminal electron acceptors, depending upon the depth of burial and oxygen concentrations in the overlying water (Dailey et al. 1993). Biogeochemical zonation of organic carbon diagenesis and nutrient recycling in marine sediments were also summarized in Dailey et al. (1993), and the environmental factors controlling sequential aerobic respiration, nitrate reduction, manganese reduction, iron reduction,

sulfate reduction, and methanogenesis have been well documented. More recent studies in the SCB are described in the following paragraphs.

Berelson et al. (2002) reported an in-depth study of organic matter diagenesis along a transect from a sewage outfall on the San Pedro Shelf. The fluxes of phosphate, silicate, and radon-222 showed the most significant difference (factor of 3) between stations proximal and distal to the sewage effluent outfall pipe; the fluxes of nitrate, ammonium, alkalinity, and total carbon dioxide (TCO₂) showed some gradient (a factor of 1.5 to 2.0), and the uptake of oxygen showed no variability between sites. Carbon oxidation in the sediments on the shelf was driven primarily by net oxygen consumption and secondarily by net sulfide reduction. Net sulfate reduction accounted for about 30 percent of the carbon oxidation near the outfall pipe and 10 to 15 percent at the distal sites. Measurements of radon-222 fluxes indicated that the intensity of bio-irrigation increased by a factor of 2 at sites away from the outfall pipe, but did occur at the site adjacent to the pipe as well.

In another study, Kuwabara et al. (1999) examined dissolved sulfide distributions in the anoxic near-bottom waters and sediment pore waters of Santa Barbara Basin. Sulfate concentrations measured in the water column outside the basin averaged 3 nmol in the 0 to 600 m depth range, while inside the basin, dissolved sulfides attained values up to 15 nmol at depths greater than 400 m. Surficial (less than 0.5 cm) porewater sulfide concentrations varied by three orders of magnitude (less than 0.008 to 0.4 μmol) at slope depths ranging from 340 to 590 m. Dissolved silicate profiles showed clear indications of bio-irrigation at shallow sites (340 and 430 m) but not in deeper basin sites (550 and 590 m) with low (less than 10 μmol) bottom-water dissolved oxygen concentrations. Porewater generation of ammonia was noted at all sites, particularly in the deep basin (590 m) site, with concentrations increasing with depth to greater than 400 μmol at 10 cm below the sediment/water interface. Decreases in water-column nitrate below the sill depth indicate nitrate consumption similar to nearby Santa Monica Basin. Peaks in porewater iron concentrations were generally observed between 2 and 5 cm deep at the 590 m site.

Nitrogen cycling in the sediments of Santa Barbara Basin was studied by Prokopenko et al. (2006). The stoichiometry of TCO₂ and NH₄⁺ production defined by porewater chemistry indicates that the only reaction influencing porewater ammonium concentrations in the sediments appears to be organic matter decomposition. The paper discusses some elegant nitrogen isotope fractionation and presents data that suggest preferential degradation of an isotopically heavier, more labile marine fraction relative to isotopically lighter, more refractory terrestrial components of the organic matter, but other possibilities could not be completely ruled out.

In another study, Severmann et al. (2006) compared the role of organic matter oxidation in Santa Barbara Basin with a site near Monterey Canyon off central California. At the Monterey Canyon site, organic matter oxidation proceeded through a number of diagenic pathways that included dissimilatory iron reduction (DIR) and bacterial sulfate reduction, whereas at the Santa Barbara Basin site, DIR appears to be comparatively small and production of sulfides (FeS and pyrite) was extensive. Variations in the dissolved iron isotope compositions between the two sites were explained by open-system behavior that involves extensive recycling of iron. This study was the first to examine Fe isotope variations in modern marine sediments, and the results show that Fe

isotopes in the various reactive Fe pools undergo isotopic fractionation during early diagenesis. Importantly, processes dominated by sulfide formation produced high $\delta^{56}\text{Fe}$ values for pore waters, whereas the opposite occurs when Fe(III)-oxides are present and DIR is a major pathway of organic carbon respiration.

Notwithstanding the various bacterially mediated diagenic processes discussed above, recalcitrant organic and inorganic contaminants can persist in marine sediments where their ultimate fate is burial and sequestration. Distributions of organic contaminants in sediments throughout the SCB have been covered extensively in previous MMS reports (Dailey et al. 1993; USDOJ, MMS 2001). The most recent synthesis of sediment contamination patterns within the coastal areas of the Southern California Bight was completed by Phillips (2007). Patterns of sediment metal, polycyclic aromatic hydrocarbons (PAH), chlorinated pesticides, and polychlorinated biphenyl (PCB) concentrations at 290 sites within coastal, port, harbor, and marina areas of the Southern California Bight were reported. Cluster analysis identified five primary site groups, with two large groups representing 96 percent of the total area of the SCB. One of these two groups contained many of the open coastal sites, characterized by relatively coarse-grained sediments (approximately 30 percent fines), low organic carbon, and low contaminant concentrations. The second large cluster group included a higher proportion of the embayment, marina, and harbor sites, with finer grained sediments (approximately 70 percent fines), and proportionally higher mean concentrations of most metals and trace organics. The other three site groups exhibited elevated concentrations for one or more contaminants, but accounted for only 4 percent of the total area of the SCB. These were mainly port, harbor, and marina sites with elevated mean concentrations of certain metals (e.g., Cu, Pb, Sb (antimony), and Zn), as well as elevated chlordane, PAH, and PCB concentrations. The fifth cluster group comprised the Palos Verdes Shelf sites that were characterized by high sediment DDT, PCB, Cd, and Ba concentrations. This group was clearly different from the other open-coastal sites. Principal Component Analysis (PCA) identified four principal components that explain 67 percent of the variance in the data set. The first two components (PC1 and PC2) accounted for 52 percent of the total variance. PC1 was highly loaded with a suite of metals (Cu, Pb, Hg (mercury), Zn, Al, and Fe), primarily for industrialized port and harbor sites. PC2 had high loadings for DDTs, PCBs, Cd, and Cr, with the highest scores for sites on Palos Verdes Shelf. The other two groups (PC3 and PC4) accounted for less than 10 percent of the total variance, with high loadings for low- and high-molecular-weight PAH and for a subset of metals (Ba, Ni, and Se (selenium)) in fines, respectively. PC1, and to a lesser extent PC3, were believed to reflect recent industrial inputs to ports (commercial shipping, boatyard operations, and small marina activities), while PC2 reflected historical, wastewater-derived inputs to the Palos Verdes Shelf. Distinct sediment contamination patterns were not evident for other large and small wastewater or riverine discharges.

3.3.2 Composition of Organic Matter

Naturally occurring organic compounds include literally hundreds (if not thousands) of known and unidentified molecules ranging from simple hydrocarbons to amino acids and proteins to carbohydrates to lipids and complex biogenic-based substances. Anthropogenic components are equally diverse and include aliphatic-, aromatic-, and heterocyclic-hydrocarbons, alcohols, ethers, aldehydes, ketones, carboxylic acids, esters, amines, amides, nitriles, thiols, sulfides, and

dozens of other chemical classes. Of particular interest for offshore anthropogenic pollution in the SCB are the persistent chlorinated hydrocarbons (PCBs, DDT, DDE, dieldrin, chlordane, etc.) and selected polycyclic aromatic hydrocarbons (PAH) and sterane/triterpane biomarkers that may be used to differentiate petroleum sources (i.e., natural seeps, production operations, sewage outfalls, riverine input, runoff, and combustion products introduced by atmospheric deposition (Wang and Stout 2007). Major constituents associated with petroleum were described previously by the National Research Council (National Research Council (NRC) 2003); they include (1) straight-chain and branched alkanes (from simple methane to compounds with 60 or more carbons); (2) monocyclic aromatic hydrocarbons including benzene, toluene, ethylbenzene, and xylene (BTEX) and other substituted benzenes with higher degrees of alkyl substitution; and (3) two- through five-ring polycyclic and heterocyclic aromatic hydrocarbons (often grouped together as PAH). Petrogenic PAHs generally have higher degrees of alkyl substitution than PAH derived from combustion processes. Stable biochemical markers in petroleum include steranes, triterpanes, and hopanes, among others. Analytical methods for hydrocarbon analyses and forensic approaches for differentiating oils and distillate products from numerous sources are reviewed by Wang and Stout (2007).

Depending on the individual compound, these organic constituents can be present in the water column as truly dissolved components, particulate substances, and colloidal fractions that are not trapped on 0.4 μm filters (Williams 1986). In addition to these individual, lower to intermediate molecular-weight components, there are also higher molecular-weight, water-soluble humic and fulvic acids derived from photochemical and microbial breakdown products of both marine and terrestrial organic matter and subsequent, longer term diagenic processes (Dailey et al. 1993; USDOJ, Minerals Management Service (MMS) 2001).

As summarized by MMS (2001) there have been no fewer than 15 major studies examining water-quality parameters in the study area. In that receiving waters are highly dynamic, and in the case of the Southern California Basins, subject to turnover on a 1- to 3-month basis (Hickey 1992), many researchers have utilized measurements of contamination in sediment and intertidal/benthic organisms as a surrogate for direct water-column analyses. In addition, since synoptic sampling of the water column throughout a region as large as the Southern California Bight is impossible, sediment and tissue samples can serve as a longtime integrator for tracking water column trends (Dailey et al. 1993; USDOJ, MMS 2001). Sediment traps near sources of contamination have also been useful in measuring the flux of organics to the benthos, and in anoxic basins where bioturbation is minimized, sediment cores can be used to track pollution levels over time. In examining the updated database for this project, several studies on contaminants in infaunal and pelagic species as they relate to water-column contamination were found.

Perhaps the most comprehensive and recent report on coastal marine fish contaminants (USDOC, National Oceanic and Atmospheric Administration (NOAA) and U. S. Environmental Protection Agency (EPA) 2007) can serve to highlight the most significant and current contaminants of concern for the Southern California Bight. Not surprisingly, because of the long-term chlorinated hydrocarbon contamination in the Palos Verdes Peninsula, contaminants of concern include 45 PCB congeners; 6 DDT isomers (p,p'-DDT, o,p'-DDT, p,p'-DDE, o,p'-

DDE, p,p'-DDD, and o,p'-DDD); the principal components of technical chlordane (cis/trans chlordane, oxychlordane, and cis/trans nonachlor); and dieldrin. In addition to the chlorinated organics, total mercury in fish tissues has also been identified as a pollutant of primary concern. Organic contaminants of principal concern for the NOAA Mussel Watch (Status and Trends) Program include this same suite of analytes plus butyltins and the full suite of parent- and alkylated-PAH (Kimbrough et al. 2008).

3.3.3 Trace Metals

Several recent publications detail the distribution of trace metals in the waters of the study region. The deposition of trace metals to the sediments has been considered by several authors recently and is relevant to water column processes as these metals generally traveled through the water column prior to deposition in the sediments. The historical inputs of Cr, Cu, Zn, Ag, Cd, Sn, Sb, and Pb to the Santa Monica and San Pedro Basins have been previously analyzed (Huh, 1998) and were found to increase from the early 1900s, peak in the 1970s, and then decrease to 1990-91 when the samples were collected. This pattern was attributed to emissions from sewage outfalls. Other studies have investigated the inputs from wastewater as well, with similar findings (Maurer et al. 1994; Huh and Venkatesan 1998). An additional study considered the distribution of trace metals in relation to stormwater runoff (Schiff et al. 2000). The distribution of anthropogenic metals in the water column, such as those emanating from San Diego Bay, have also been investigated (Esser and Volpe 2002; Volpe and Esser 2002), though not with sufficient resolution to assess broadscale distributions. One exception is that of lead.

The distribution of lead within the waters of the study region was reported by Sanudo-Wilhelmy and Flegal (1994). This research, with samples collected in 1988-1989, showed a threefold decrease in lead concentrations in the southern extreme of the study region relative to previous studies. This decrease coincided with the reduced input of lead to the ocean due to the phase-out of leaded gasoline and improved water treatment systems. Based on isotope distributions, the authors suggested that upwelling of lead to the surface waters was the main source, and that the lead likely originated from Asian lead aerosols. Increased emission from Mexico was also noted.

3.4 THE PETROLEUM SEEPS

3.4.1 Marine Seep Overview—What Is a Seep?

Hydrocarbon seeps are places in the ocean floor where hydrocarbon gases and fluids escape the lithosphere into the hydrosphere or atmosphere. Where there is sufficient flow, gas seepage manifests as bubbles; for lower flow it manifests as diffuse hydrocarbon-rich fluid. Below a certain threshold, microbial degradation prevents seepage from reaching the surface.

Seeps can be of geologic or biologic origin; however, seeps releasing petroleum hydrocarbons are necessarily thermogenic in origin, and these seeps are the focus of this section. Thermogenic seepage occurs from a reservoir layer in which ancient carbon buried over geologic eons eventually reaches sufficient pressure and temperature for conversion into petroleum. The liquid petroleum then penetrates the relatively impermeable capping layer, which usually prevents

escape of the hydrocarbons, when that layer either erodes or is penetrated by faults and fractures that can then provide migration pathways for focused seepage (Hunt 1995; Whelan et al. 2005).

Where the reservoir contains oil and gas, the gas flux drives the oil migration. In such a case, the oil generally escapes as oil-covered bubbles, although oil can escape without the associated gas causing the release. For example, gas pressure behind an oil-blocked pathway can lead to a flux of oil covered bubbles, or geologic pressure can lead to a flux of oil or oil covered bubbles. Because natural gas dissolves in oil, effervescence (the formation of bubbles) may occur in the oil drops. Whether oil droplets contain bubbles is important for marine seepage because the rise velocity of an oil droplet is significantly less than that of an oily bubble. An oil droplet that contains a bubble will rise faster than a droplet without a bubble. With faster rise time, the oil droplets that contain bubbles will generally surface closer to the source as they are not subject to the local currents for as long a time as the slower droplets (Leifer and Wilson 2004).

The point where seepage escapes from the earth is termed the vent mouth, and its geometry is important to the character and hence fate of the seeped hydrocarbons. Often, there are multiple vents in close proximity (Leifer et al. 2004). The underlying controlling subsurface geologic structures create pathways between multiple vents, forming a seep area where the connectivity between vents mean that seepage change in one vent affects the other connected vents (Leifer and Boles 2005).

3.4.2 Hydrocarbon Migration from the Reservoir to the Seabed

3.4.2.1 Control of Seepage by Faults and Fractures

Marine seepage from these pathways manifests at the sea floor as mud volcanoes, pockmarks, and bubble plumes (Milkov 2000; Kopf 2002; Whelan et al. 2005). Important seepage controlling factors are tectonic; for example, mud volcanism most commonly is associated with the local tectonic setting relative to compression (Kopf 2002). Fold-and-thrust fault belts are a prominent setting for fluid migration from deeper layers through faults and fractures, allowing accumulation of hydrocarbons in anticlines and other traps (Bonini 2007). In some settings, geologic structures close to the seabed, such as those formed of authigenic carbonates and low permeability sediment (e.g., clay) layers (Boetius and Suess 2004) can be important in controlling flux rates. Faults and fractures, which can provide migration pathways, are located in regions associated with noncompressional geologic stresses (Naudts et al. 2006; Leifer et al. 2009b). Thus, anticlines, where rocks folds are convex, can be associated with seepage, given that there is hydrocarbon accumulation in underlying layers, while synclines, where rock folds are concave, do not even have the presence of underlying hydrocarbon accumulations. For example, in the Coal Oil Point seep field, ([Figure 3.1](#)) seepage along the S. Ellwood seep trend is associated with the S. Ellwood anticline, while seepage is absent from the syncline immediately inshore of this anticline (Fischer 1978; Leifer et al. 2009b). Further, these studies propose that seepage occurs at nexuses of faults where capping rock layers can be heavily fractured, offering multiple low-resistance migration pathways.

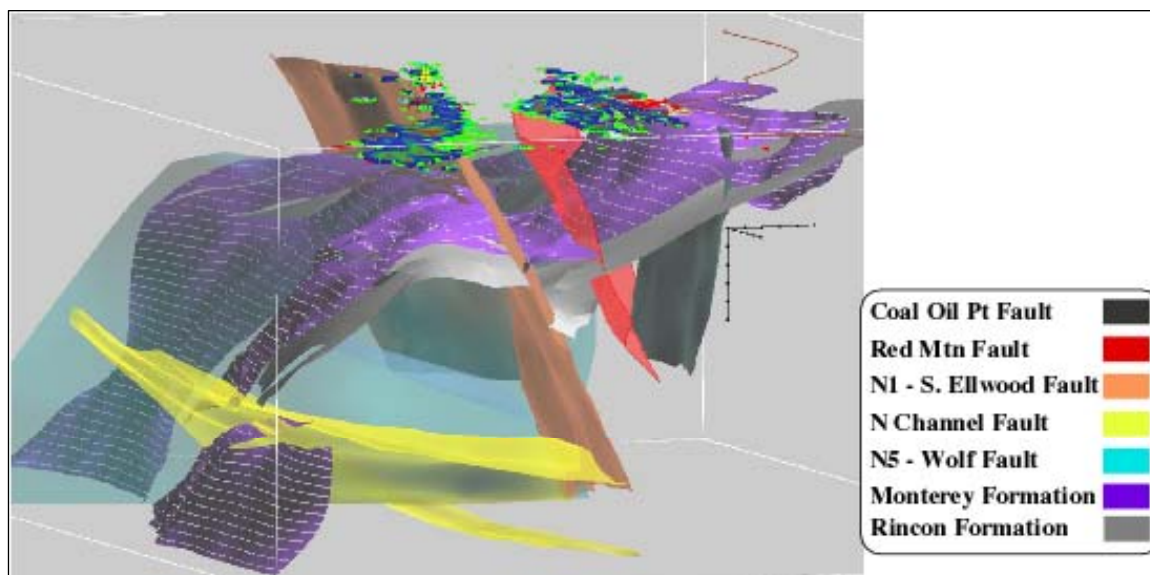

Figure 3.1. Coal Oil Point seep field distribution and underlying geologic structure oblique view from above looking northwest through transparent sea surface showing faults, Monterey Formation (MF), and seep gas spatial distribution (red strong emission, blue weak), and top of the Rincon Formation.

Outline of MF outcropping is sea surface projection. MF depth contours on MF every 1 km. Projection is uniform with orientation axis, with size scale dots on axis every 200 m. Platform Holly is owned and operated by Venoco, Inc. (Leifer et al. 2009b). Seepage theoretically occurs at nexuses of faults where capping rock layers can be heavily fractured, offering multiple low-resistance migration pathways.

3.4.2.2 Reservoir Layer Accumulation and Migration in the Reservoir Layer

Clearly, a requisite condition for hydrocarbon seepage is the presence of a hydrocarbon reservoir. Offshore California, the primary reservoir is the Miocene-age Monterey Formation (MF), which is composed of siliceous shales, organic shale, porcellanite, chert, and dolostone. The MF is both a hydrocarbon source with active hydrocarbon formation at depths below approximately 3 to 4 km (Olsen 1982; Kamerling et al. 2003) and a fractured reservoir with high porosity (10 to 30 percent). Although its permeability is low due to grain size, fractures are very permeable and therefore provide important migration pathways (Finkbeiner et al. 1997). The MF is overlain by the relatively impermeable Pliocene-age Sisquoc formation, which forms the seal for hydrocarbon accumulation. The Rincon Formation underlies the Monterey Formation and is also a hydrocarbon source (Olsen 1982). Hydrocarbons from the Rincon Formation likely seep into the Monterey Formation through deep faults that penetrate both formations. Current understanding of the role of the Rincon Formation in seepage is very poor compared with that of the Monterey Formation from which most petroleum production originates. The Pliocene-age Pico formation also is a hydrocarbon reservoir, with hydrocarbon accumulations identified in the Santa Maria Basin, trapped by MF strata (Crain et al. 1985).

Geology controls the location of seepage along the coast; shallower crests of the MF correlate with regions of stronger seepage. The shallowest portion of the MF occurs offshore of Coal Oil Point, where the MF actually outcrops ([Figure 3.1](#)). Hydrocarbon emissions in the Coal Oil Point Seep field are the greatest for this portion of the California coast (Allen et al. 1970); seepage is weaker at numerous other locations. The relative strength here is in part the MF's shallowness, which is a result of tectonic processes of folding and faulting at Coal Oil Point. Although MF outcropping occurs offshore at Summerland, hydrocarbon deposits there are isolated from the deeper MF by folding. Thus, the first offshore oil wells in the world, which were drilled in the late 1800s into the Summerland Formation offshore at Summerland (Arnold 1907; Leifer and Wilson 2007), went dry in a few decades (Grosbard 2002). Although outcropping is noted in the Santa Maria Basin offshore at Point Conception ([Fig. 3.2](#)), and seepage has been noted there (Fischer 1978), the geology is not well understood. As a result, it is unclear why seepage is weaker in the Santa Maria Basin than it is offshore of Coal Oil Point.

Key to the process of seepage above crests and outcroppings of the MF is migration of oil and gas within the MF and accumulation in its shallower portions. The MF is highly fractured, with significantly lower permeability along the rock layer directions. Because migration is gas driven, it occurs preferentially in an upward vertical direction, i.e., updip and along layers within the MF. Migration is more vertical within the MF where faults and fractures penetrate it. This allows hydrocarbon migration to upper strata of the MF, where it contacts the capping Sisquoc Formation (Leifer et al. 2009b). Where faults and fractures penetrate the capping layer in a zone of hydrocarbon accumulation or above hydrocarbon migration pathways within the MF, seepage can be significant. Because of these migration processes, hydrocarbons accumulate at shallower crests in the MF along the coast. Where seepage occurs faster than migration within the MF, there will be no hydrocarbon accumulation, at least over a long time period, and thus no relationship between hydrocarbon accumulation and seepage exists.

Because active hydrocarbon formation occurs offshore, where the Monterey Formation depths are greater than 3 to 4 km (Leifer et al. 2009b), migration occurs in an onshore direction where the MF is shallower. Migrating hydrocarbons become trapped in crests of anticlines, creating hydrocarbon accumulations such as the S. Ellwood anticline.

The entire Santa Barbara basin is underlain by the Monterey Formation, thus it is likely that hydrocarbon migration also occurs toward the Channel Islands on the southern boundary of the Santa Barbara Channel. Surveys to date have failed to demonstrate conclusive evidence of seepage here, thus potential seepage is likely to be either small-scale or intermittent. Hydrocarbon seepage also has been detected at the mid-channel trend, a ridge of uplifted seabed including pockmarks and active venting (Eichhubl and Boles 2000), where the MF rises from greater depths (Eichhubl et al. 2002).

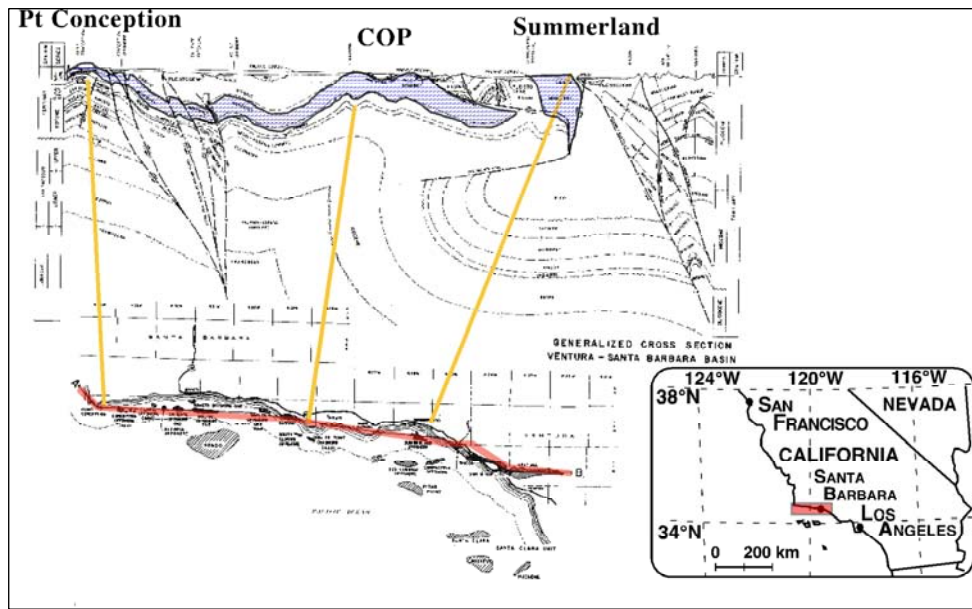

Figure 3.2. Generalized geologic cross-section of the Ventura and Santa Barbara Basins. COP is Coal Oil Point.

(Source: California Division of Oil and Gas 1991)

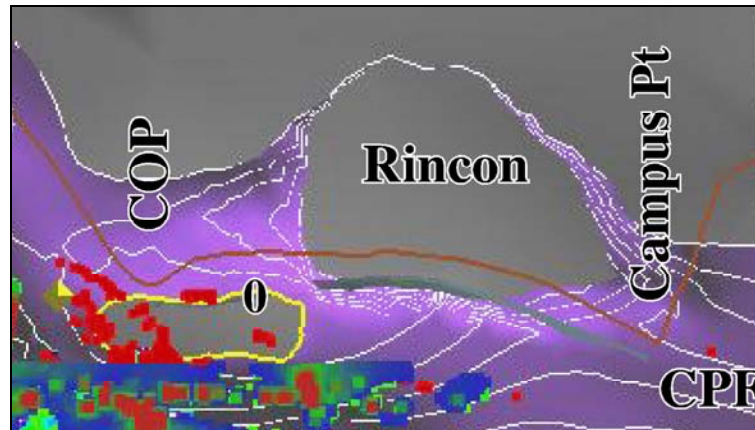

Figure 3.3. Map view of Monterey Formation depth (100 m contour lines) offshore of Coal Oil Point, Global Position Satellite survey locations of seepage (red dots) and sonar return data (red = high, blue = low); yellow line indicates outcropping; CPF is Coal Oil Point fault.

(Source: Leifer et al. (2009b).

3.4.2.3 Outcropping Seepage

Where the overlying capping layer has been eroded, the formation layer may be exposed, allowing hydrocarbon migration at the seabed from the outcropping. An example of outcropping seepage occurs from the inshore seepage trends of the Coal Oil Point seep field (Fig. 3.3). Here, where seepage was identified largely from GPS surveys (kelp beds prevented sonar surveys), the

seepage largely outlines the outcropping (Kamerling et al. 2003). However, there is a SE-NW trend that traverses the outcropping. This seepage trend likely results from a fault (Fischer 1978; Leifer et al. 2009b), creating a migration pathway through the Monterey Formation allowing hydrocarbons that are migrating along deeper layers of the MF, or even from the Rincon Formation, to travel to the seabed (Figure 3.4). Slightly farther offshore is a second, parallel seepage trend, which cuts off the outcropping on the southwest. North of the outcropping, the MF dips almost vertically. This severe fold is controlled by the Coal Oil Point fault, which does not reach the seabed (Olsen 1982) and delineates seepage to the northern edge of the outcropping. Although seepage from the offshore side of the MF outcropping contains both oil and gas, seepage from the inshore side of the outcropping is only gas (Leifer, 2009). The reason for this difference is unknown.

A schematic diagram identifying the seepage characteristics that can be inferred from the spatial distribution of seepage around and in the outcropping is shown in Figure 3.4. That seepage outlines the outcropping attests to the significantly lower permeability in the MF to migration in a parallel rather than perpendicular direction to strata layers (Eichhubl and Boles 2000). Where fractures occur in the MF, vertical migration can occur. In the case of discontinuity in fractures across the Monterey and Sisquoc Formation contact, migration will occur along the contact, surfacing at the edge of the outcropping. Where faults penetrate the Monterey and Sisquoc Formations, hydrocarbons migrating along the contact, and also along deeper layers, will move vertically. However, the presence of seepage along a trend traversing the outcropping indicates the presence of hydrocarbon accumulation under the outcropping, likely at a crest in lower layers of the MF. These hydrocarbons then migrate to the seabed through low permeability pathways associated with faulting of the MF layers. Moreover, seepage surrounding the outcropping is far weaker than that closer to the dropped block south of the Red Mountain Fault (near Sea Cliff, Casitas Springs and Oak View, California), thus vertical migration along faults is far lower permeability than along MF strata layers.

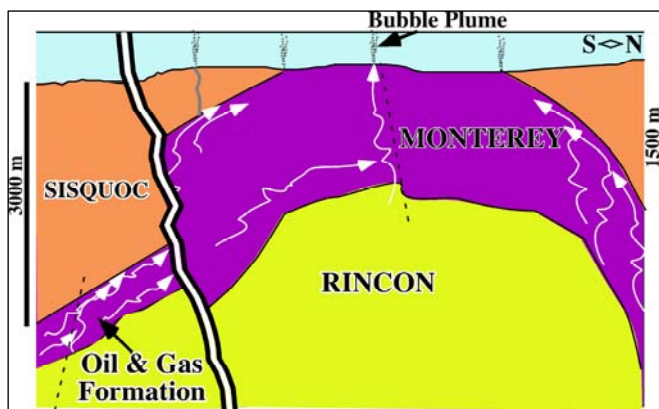

Figure 3.4. Schematic showing outcropping seepage mechanisms. Dashed lines are faults.

(Source: Leifer, based on data in Figures 3.1 and 3.2).

3.4.2.4 Overburden Control of Seepage

The fate of seepage gas in the water column (dissolution or transport to the sea surface) depends on the seepage characteristics. Larger bubbles persist longer and transport more of their methane to shallower depths than do smaller bubbles (Leifer and Patro 2002). Thus, oil on larger bubbles is more likely to be transported to the sea surface at bubble rise velocities (20 to 30 cm/s) than is oil on smaller bubbles. Where the bubbles are very oily—that is, where they are better described as an oil droplet with small encapsulated gas bubbles—the rise can be a fraction of the normal bubble upwelling velocity (Leifer and Wilson 2004). Once the bubble dissolves or where oil escapes absent a gas phase, the oil droplets rise slowly toward the sea surface, at a rate of about 1 cm/s or less, based on the small density difference between water and oil and the droplet size. Where there are a variety of droplet sizes with some rising more slowly, the surface oil footprint can spread tens to hundreds of meters downcurrent of the seepage location. A progression of oiliness of surfacing bubbles with downcurrent distance from the main bubble seep plume is observed from numerous seeps in the Coal Oil Point seep field (Leifer 2009; Leifer et al. 2009a).

Although at higher flux (major plumes), seep bubbles escape the seabed as a plume with a broad size range, at lower flows (minor plumes) the range of sizes is narrow. The bubble size of minor plumes depends on the vent orifice size (Blanchard and Syzdek 1977) and the flux (Oguz and Prosperetti 1993). Except for where seep bubbles escape from outcroppings, the bubble size distribution is related in a complex manner to the sediment grain size (Leifer and Culling 2009).

The thickness of the sediment layer offshore of Coal Oil Point affects the spatial distribution of the seepage emissions. Bubbles migrate from vents in the underlying rock strata, which are related to the controlling geologic structures (Leifer et al. 2009b). Sediment blurs the relationship between the spatial distribution of the seepage and the underlying geology by redirecting the bubbles as they travel upwards through sediment spaces. Where sediment layers are thin, the effect is minimal, and even low flow vents tend to be located at quasi-permanent locations (Leifer et al. 2004). Sediment overburdens for most of the seep field are thin ([Fig. 3.5](#)). Migration pathways through sediment are more likely to be more variable, unlike pathways through fractures in rocks. To the west of the seep field, the sediment overburden increases to several meters thick, which likely causes greater variability.

Where the sediment is very fine grained, bubbles cannot easily slip through the pathways of the sediment without moving many sediment grains. Here, elastic failure becomes a key process in bubble migration and formation from the smallest grain size. One result is that bubble emissions tended to be in transient pulses separated by times longer than the pulse length (Leifer and Culling 2009). The migration pathway for fine-grained sediments is more variable than for coarse-grained sediments, although once migration by elastic failure has occurred through a specific pathway, it is more likely to occur again repeatedly through the same pathway.

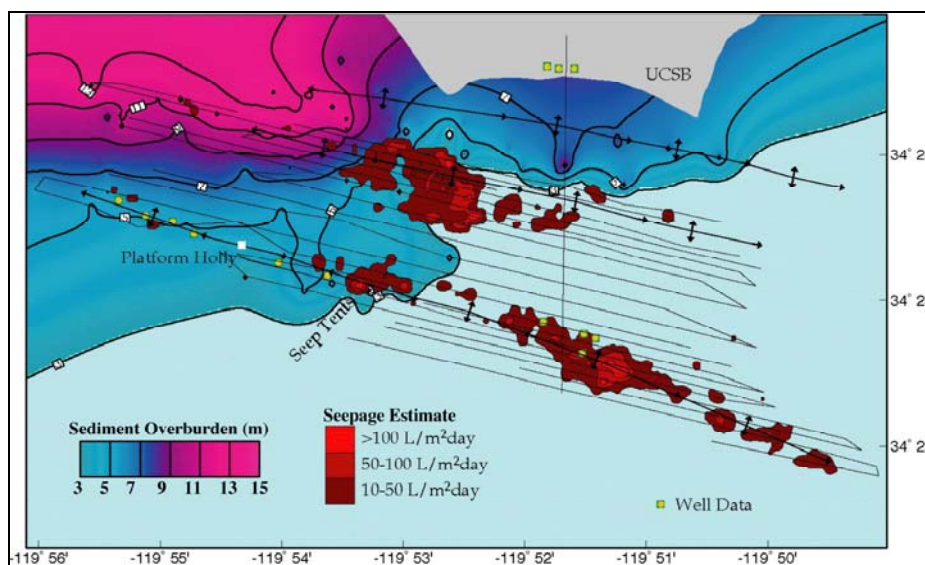

Figure 3.5. Map of sediment overburden and sonar-return derived map of seepage emissions.

(Sources: Sonar, Hornafius et al.(1999) ; sediment layer, Bruce Luyendyk, UCSB, unpublished data, 2008).

3.4.3 Temporal Variations in Emissions

3.4.3.1 Overview

There is a range of both external and internal factors that cause temporal variability in seep emissions. Hydrostatic pressure changes caused by tides have been shown to affect the emission of gas in the Coal Oil Point seep field (Boles et al. 2001) and of oil (Mikolaj and Ampaya 1973; Leifer and Wilson 2007). Pressure changes due to swell coming in toward the beach from offshore affect emission rates on a shorter timescale. Under changing pressure conditions, lower hydrostatic pressure corresponds to higher emissions. The swell induced changes in emissions are due both to hydrostatic pressure changes, and near-seabed fluid motion (surge) (Leifer and Boles 2005). Although no data are available for the large swell and surge associated with storms, these conditions are likely to increase seepage emissions.

The other key external factor that could affect seepage is rain and the resulting aquifer recharge. Although its effect on seepage is speculative, the possible mechanism is that seasonal California rains rapidly replenish aquifers depleted during the dry season, leading to a rapid increase in pressure in onshore aquifers. Because rock strata run under the Santa Barbara Channel and are heavily fractured by faulting, it is likely that pathways exist that allow hydraulic pressure to affect reservoir layers and migration pathways under the seep field. There, an increase in hydraulic pressure could lead to an increase in seepage. In the case of significant and rapid increase in pressure, new pathways could be formed. This mechanism was proposed to explain observations (based on aerial surveys (see Fig. 3.6) and boat surveys (Anderson, 2005) that seep field oil emissions after the exceptional Southern California rains of January 2005 dramatically increased.

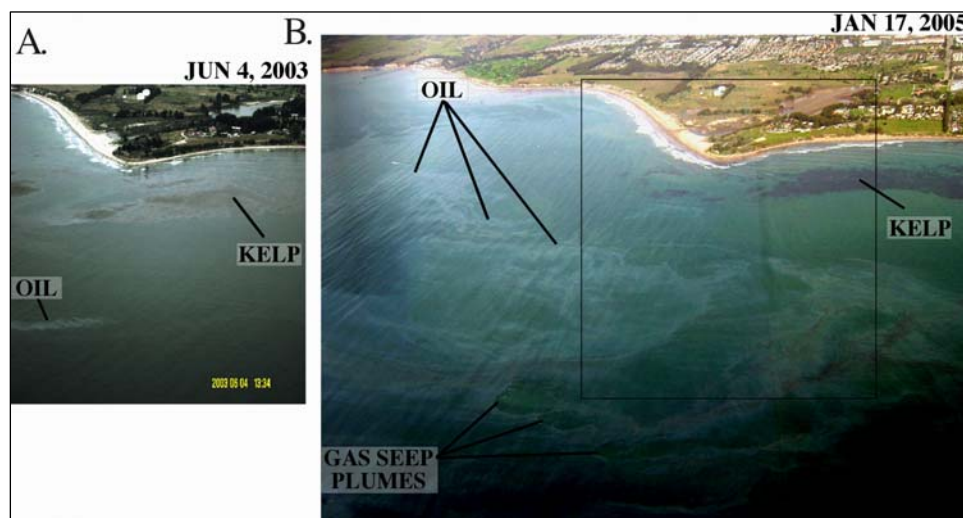

Figure 3.6. (A) Aerial photo taken June 4, 2003, showing typical seepage in the near-shore seeps off Coal Oil Point.

Image was vertically stretched to match perspective in (B). Inward from oil slick shown in (A). (B) Aerial image from shortly after the January rains. Box outlines the same region as shown in photo in (A) and shows vastly larger amounts of oil seepage. New and intensified gas seep plumes were observed. Oil-free areas around gas seep plumes are a result of bubble-driven outwelling flows.

(Source: Photos A. Chris McCullough, Dept. of Conservation, and Ira Leifer, University of California, Santa Barbara).

3.4.3.2 Geologic Control of Temporal Variations in Migration Pathways

In addition to external factors, seepage changes occur as a result of internal, that is, subsurface, changes. These subsurface effects can originate from human activities, such as increased reservoir pressure due to re-injection or decreased reservoir pressure due to production depressurization. Using data collected in 1973 and 1995, Quigley et al. (1999) demonstrated a decrease in the area and number of seeps within 1.5 km of platform Holly that they attributed to production activities. Long-term, decadal changes in the seep field occur. Fischer and Stevenson (1973) noted changes in hydrocarbon seeps on decadal time scales in the Coal Oil Point area, with a significant decrease in seepage areas between 1946 and 1973. Based on a comparison of sonar data and oil company seep maps, this drop was attributed to offshore production. However, the relationship between production and emissions is complex. Analysis of sonar maps spanning a decade show no clear overall trends in seepage from different areas of the seep field besides those in the vicinity of platform Holly, where emissions have decreased significantly over the decades (Quigley et al., 1999; Leifer et al. In press). No quantitative data on seep emissions, much less temporal trends, are available outside the Coal Oil Point seep field. Thus, applying conclusions from the Coal Oil Point seep field to other settings could be inappropriate, given the current state of knowledge elsewhere.

Given the dominance of geologic control of the seepage, seepage is quasi-permanent and occurs at specific confluxes of geologic structures (faults, nexuses of faults, anticlines, and reservoir

formation slope, etc.). This close relationship between seepage and geology suggests that seismic activity can affect seep emissions, either by creating new migration pathways or disconnecting existing ones. Geologic changes also are likely to result from faults at deeper offshore depths than that under the seep field, thus causing seep-field-wide changes on decadal and longer time scales. Consideration of long-term seep field seepage trends supports this hypothesis. Geologic evidence suggests the Coal Oil Point seeps have been active on the northern edge of the Santa Barbara Channel for at least 500,000 years (Boles et al. 2004). Comparison with current seep maps (e.g., Fig. 3.1) and earlier maps (Fischer and Stevenson 1973) suggests a continuous decrease in seepage emissions. A linear extrapolation of the long-term, decadal trend in seepage reduction suggests unreasonably large seepage in the past and a cessation of seepage in the next century, both of which are unlikely given the known age of the field. It is more likely that seepage on long (century) time-scales is cyclical, with more active periods followed by quiescent periods. Analysis of two decades of hourly air pollution data from the West Campus Station, which is operated by the Santa Barbara Air Pollution Control District, showed consistent overall decrease in seepage through the late 1990s, followed by increases which that may have reached a plateau 2005-2007 (Bradley et al. 2009). These changes were widespread indicating they resulted from deep reservoir processes, which were hypothesized as most likely related to seismic activity (Bradley et al. 2009).

Such behavior would mirror seepage trends observed on shorter time scales. There is also evidence of large-scale balance between pressure and available migration pathways. For example, in the 1990s, the largest seepage area in the inshore seep area was the Coal Oil Point seep, which persisted for at least half a decade (Egland 2000). However, a new major seep area, the Trilogy seep area, developed around 2005 and has been the dominant major seep area in the inshore seeps since that time (Leifer et al. 2009b). For the last half-decade or so, the site of the original Coal Oil Point seep has been quiescent. This suggests that seepage shifted from one low permeability pathway (high intensity seep) to another, which did not represent a change in the reservoir pressure. One potential and likely mechanism is oil deposition in the migration pathways, forming tar. This tar is formed through the process of gas washing removal of more volatile components, which gradually converts the oil to tar. The increasing blockage of migration pathways leads to decreased migration (emission flux) and a concomitant increase in pressure in the reservoir layer. This pressure then increases until a new pathway is formed, as in the Trilogy seep. Since its appearance, Trilogy seep has evolved, with two of the main bubble plumes becoming more dispersed and increasingly oily (Figure 3.7).

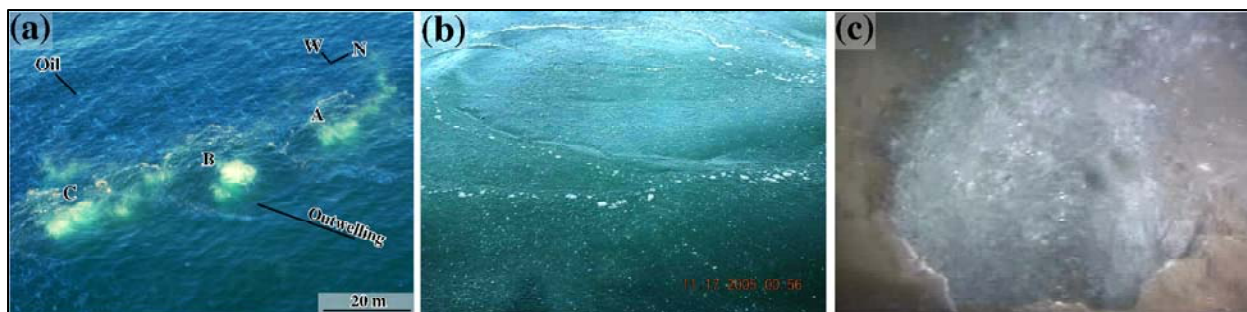

Figure 3.7. Images of Trilogy seep area: (a) aerial, (b) from boat, (c) from submarine.

(Source: Leifer et al. (2009a).

Leifer and Boles (2005) introduced the concept of interconnectivity, where decreases in seepage from a vent or group of vents causes increases in seepage at others. They observed shifts between seepage on meter length scales. The explanation they hypothesized is the interconnectedness of the subsurface migration pathways and the increase or decrease in pressure in the subsurface reservoirs due to changes in resistance along a migration pathway. The model was used to explain temporal variations in emissions between oil and gas from two vents at an abandoned oil well offshore of Summerland (Leifer and Wilson 2007).

3.4.3.3 *Transient Emissions*

One of the main causes of variability in seepage emissions is tar deposition in migration pathways (Leifer and Boles 2005). At Shane seep (34° 24.370'N, 119° 53.428'W), a blowout was observed that was thought to relate to tar deposition (Leifer et al. 2006c). SCUBA divers videotaped a cessation of seepage in a wide area of the seabed at one of the main vents of Shane seep for several minutes, followed by an eruption of gas. Video of the event showed tar raining out of the rising bubble plume. Presumably, tar blockage of the major seep conduit at some depth below the seabed allowed a depressurization of seepage in shallower interconnected pathways by cutting off the hydrocarbon flow. The blockage also led to a rapid increase in the pressure behind itself, which after a few minutes, broke free and caused the blowout. Based on modeling data from an air pollution monitoring station, the blowout emission was 120 m³ over a 5-minute period. A much smaller blowout, or large transient event (0.5 m³), was recorded during a deployment of three turbine flow measurement tents at the seabed at Shane seep. In the tent with the blowout, there was a cessation of seepage for several minutes prior to the blowout, as well as immediately afterwards. Then, seepage increased to a level significantly higher than prior to the transient release event. Again, the blowout was thought to have been caused by tar deposition and blow-through, with the higher flux afterwards interpreted as a possible result of tar removal from the migration pathway leading to lower resistance. As a result, total emissions were mostly affected by the change in emission resulting from the event rather than the actual event itself.

Emissions at a second site showed the reverse emission trend, suggesting connectivity deeper than the blockage point, while the third test exhibited no related trend. This difference illustrates the complexity in predicting the effect of emission changes at one location on another. Based on these data, Leifer and Boles (2005) proposed that although seepage might be zero sum, with seepage increases at one area matched by decreases elsewhere, changes in emissions are related to changes in the total resistance of the seep area, and thus are not zero sum.

Transient emissions of oil and gas are important for several reasons. First, because they are infrequent, they are unlikely to be quantified, thus flux estimates only represent the nontransient emission mode. However, based on the observation that the dominant effect of a blowout event was not the transient release but the change in emission rate afterwards, uncertainty from not quantifying transient emissions is likely to be small. An exception to this is where a transient emission occurs from a site that has zero emissions both before and after a blowout event.

One clear reason transient emissions are important is that they more efficiently transport methane and oil across the water column, with less bubble dissolution and faster upwelling of flows (Leifer et al. 2006c). Transient emissions have different plume processes than nontransient plumes (Leifer et al. 2009a), thus characterization of transient emissions is important to understanding initial processes in pipeline blowouts. Moreover, in some cases, transient emissions may be associated with large oil emissions. Where significant oil accumulates in a migration pathway, it increases the resistance to flow, increasing the pressure across the oil reservoir, therefore leading to a transient pulse of gas when the oil slug escapes. Such interplay between gas and oil, albeit at low flow, was quantified for emissions from an abandoned oil well offshore at Summerland, California (Leifer and Wilson 2007).

3.4.3.4 Tar Deposition at the Seabed

Unlike tar deposition in the migration pathways, which is an internal process, tar can also be deposited externally at the seep orifice and vents, blocking emission pathways with tar caps, constricting orifices, and thereby changing the bubble size distribution. Leifer et al. (2004) repeatedly mapped the location of seepage and related seabed features over several years at Shane seep. They observed plasticity in the seabed morphology, which was attributed to a shallow gas pocket or layer that was capped by a tar layer under the sediment. Although surveys suggested that these tar-related seabed features were persistent only on annual time scales, tar paddy observed at Jackpot seep (Leifer et al. 2007), was also reported in 1969 (Allen et al. 1970), suggesting decadal permanence; however, it is unknown if the seabed features are the same or simply similar.

Tar deposition at the seabed by these mechanisms (not sedimentation), can be removed by internal processes, such as increased emission fluxes, and also by external processes, such as scouring by wave action and currents. Thus, seepage may be affected by internal aquifer pressure effects, and external by storm induced swells.

3.4.4 Transport from Seabed to Sea Surface

3.4.4.1 Overview

Understanding the processes governing the fate of marine hydrocarbon seepage in the water column is important because natural seep petroleum emissions are 600 kilotons per year or 40 percent of total annual emissions of 1300 kilotons per year (Coleman et al. 2005). A second reason is because the same processes affecting seep emissions also affect hydrocarbon emissions from subsea oil spills as small as a pipeline leak to a blowout.

Most hydrocarbon seepage escapes as individual bubbles, bubble streams, or bubble plumes, or, finally, as intense megascale bubble plumes (Leifer et al. 2006a; Leifer and Culling 2009). In some areas, oil escapes without gas bubbles as tar whips or oil droplets (Fischer 1977; Lorenson et al. 2009 in prep). Where seepage escapes as dispersed bubble streams, or individual bubbles, the bubbles are less likely to reach the sea surface due to bubble dissolution, except from very shallow seepage from bubble plumes (Leifer et al. 2006c). The fate of the bubbles depends most strongly on several factors, of which depth and size are most important, although the presence of surface-active substances, surfactants (Leifer and Patro 2002), or oil coating (MacDonald et al.

2002) , lead to enhanced bubble life. Where seepage escapes as oil droplets or tar whips, it rises to the sea surface far slower due to the significantly lower density difference between water and oil versus between water and bubbles.

The seep bubble size depends on the flux at the vent and the vent geometry (Leifer and Culling 2009). Very few bubble emission size distributions for marine seeps have been published, although these authors proposed classifying seep bubbles as minor and major, corresponding to lab observations of bubble plumes from capillary tubes. Minor bubble plumes are formed from capillary tubes for low flow, Q , and have a narrow size distribution, Φ , which is well described by a Gaussian function (Leifer and Culling 2009). Although seep bubble measurements by Leifer and Boles (2005) and MacDonald et al. (2002) indicated that minor bubble plumes are in the range 2,200 to 3,500 μm radius, analysis of a large number of minor plumes found peak radii from 600 to 12,000 μm (Leifer 2009). Where minor plumes are oily, the peak bubble size for the same flow was reduced (Leifer 2009).

With increasing Q , turbulence intensifies and smaller bubbles begin to appear. Finally, a broad, weakly size-dependent, Φ is produced for higher Q (Slauenwhite and Johnson 1999) that is well described by a power law (Leifer and Culling 2009). In general, major plumes have a greater Q than minor plumes and their Φ includes larger bubbles. However complicating this simple characterization is the effect of vent size; larger orifices produce larger bubbles, thus, a major vent plume can have lower Q than some minor plumes. Where major plumes are oily, tiny oil droplets are formed during bubble fragmentation, which is characteristic of major plumes. These oil droplets rise far more slowly than bubbles and drift out of the bubble plume, rising along trajectories that are distinct from those of the bubbles (Leifer et al. 2009a).

Leifer and Culling (2009) identified another plume class, termed “mixed,” whose Φ could be described (albeit poorly) by a combination of power laws and Gaussian functions. Based on lab studies, mixed plumes appear to form from unconsolidated and mobile sediments. For high Q , Φ for emission from mixed plumes approaches Φ for major plumes. Thus, sediment or orifice geometric characteristics become less important with increasing Q .

Another type of vent for which there are no published bubble size distributions occurs by the mechanism of elastic failure. Elastic vents occur where the seabed behaves elastically, such as for migration through tar-saturated or unconsolidated, fine-grained sediments. Bubble emission occurs when sediment cohesiveness “fails” and a migration pathway opens for bubbles to escape. The pathway then seals, allowing gas build-up until the next emission. Because this seep migration mechanism implies an absence of permanently open pathways, it is similar to gas-charged sediment ebullition in which bubbles migrate via “elastic failure” (Johnson et al. 2002; Boudreau et al. 2005). This mechanism can produce a random or quasi-random temporal and spatial distribution of emissions. Typically, bubble emission is episodic, while individual events may include extremely large bubbles (Leifer and Culling 2009).

3.4.4.2 Single Bubble/Droplet Transport

Due to their greater buoyancy, bubble exhibit rise speeds orders of magnitude faster than those of similar size oil droplets. Therefore, vertical bubble-mediated oil transport is markedly more

rapid than unaided pure oil droplet rise, and water-column transit time is significantly reduced. Because most oil has a density close to that of freshwater, even bubbles that are predominantly composed of oil still rise significantly faster than pure oil droplets of the same size. An effect of the decrease in water-column transit time is a reduction in the size of the surfacing footprint because there is less time for dispersal due to turbulence and currents (MacDonald et al. 2002).

Bubbles rapidly accelerate to their terminal velocity and rise toward the sea surface. Factors affecting bubble rise (and momentum transfer) include size, temperature, and surfactants as well as oil. Both rise velocity and gas exchange are faster for clean than surfactant-contaminated bubbles (Clift et al. 1978). As bubbles rise, they exchange gas with the surrounding fluid. This gas exchange is driven by the concentration gradient across the bubble interface. The gas outflow rate increases rapidly with depth (Leifer and Patro 2002). The fate of the bubble's gas depends on this dissolution rate and the rise rate.

3.4.4.3 Plume Transport

Bubble plume processes occur in regions of high bubble concentrations, where the fluid properties (dynamic and chemical) are significantly different from the surrounding ocean. Bubble plumes transfer momentum to the surrounding fluid, creating an upwelling flow (Leifer et al. 2009a). Also, bubble dissolution is slower in a bubble plume because of the higher aqueous concentration of gas in the plume from bubble outgassing (Leifer et al. 2000; Clark et al. 2009). Further, bubble plumes generally exhibit a broad size distribution that includes larger bubbles. Larger bubbles have greater volume, rise more rapidly, and have higher volume-to-surface-area ratios than smaller bubbles.

Upwelling flows have been identified in seep bubble plumes in the Coal Oil Point seep field (Leifer et al. 2000; Leifer et al. 2009a) and the Gulf of Mexico (Leifer and MacDonald 2003). Bubbles rise in the upwelling flow at their terminal velocity, thus their transport across the water column is far faster than for a single bubble. Also, upwelling flows transport deeper water vertically, which includes entrained oil droplets (Leifer et al. 2009a). Where the upwelling flow reaches the sea surface, it spreads outward in an outwelling flow and forms horizontal intrusions. The surface outward velocity decreases with radial distance, and the thickness of this outwelling flow becomes thinner (Fanneløp et al. 1991).

Leifer et al. (2009a) created a range of bubble plumes at sea and measured the upwelling flow. Bubble plumes were produced for flow rates spanning three orders of magnitude and produced upwelling flows from 10 to 50 cm/s with $V_{up} \sim Q^{0.23}$, that is, V_{up} is weakly sensitive to the buoyancy flux. Other researchers have found a relationship of $V_{up} \sim Q^{0.25}$ (Matsunagi and Miyanaga 1990) and $V_{up} \sim Q^{0.33}$ (Lemckert 1993).

3.4.4.4 Megaplume Transport

There are several megaseeps in the Coal Oil Point seep field. Megaseeps are so termed because they release approximately 10^6 L/day (Washburn 2008). Although a megaseep can form from a single vent, it also can form from many bubble plumes, which then combine into a single plume in the water column. Plume processes are far stronger in a megaplume, both the upwelling flow and the saturation of the plume water (Leifer et al. 2006c). In the Seep Tent seep megaplume,

upwelling flows of up to 1 m/s were measured and super-saturation of methane equivalent to 1.4 bar was recorded (Leifer et al. 2000). Strong outwelling flows are observed at megaplumes, too (Leifer et al. 2009a). As a result, much smaller bubbles, which would have dissolved in a small plume, survive to the sea surface. Megaplumes have very high flow rates, indicating a highly permeable subsurface migration pathway that allows the high flux to pass from the reservoir to the sea surface. As a result, the hydrocarbons spend far less time subsurface in the migration pathway. Leifer et al. (2006b) noted that the oil slick from the Shane seep megaseep had far greater volatile component than oil from smaller seeps.

3.4.4.5 Transient Emissions

Although seep emissions generally are gentle emanations of bubbles from the sea floor, seep emissions can also occur transiently. During a large transient emission, bubble plume processes are enhanced significantly over those of a normal plume or megaplume. Leifer et al. (2006c) observed an upwelling flow of 300 cm/s for a blowout of 0.4 m³/s that lasted for 5 minutes at Shane Seep. Numerical simulation of the blowout showed that very little of the original methane was lost during the rise to the sea surface, only 1.1 percent versus 10 percent for the megaplume. Applying the simulation to a blowout from 250 m showed only 11 percent was lost. Thus, transient releases provide an efficient mechanism for bubble plumes to transfer methane, oil, and entrained fluid from the deep sea to the sea surface.

There is significant evidence that transient emission is an important seepage mode. Large transient emissions may be associated with pockmarks, a common feature in marine sediments worldwide (Hovland et al. 2002). Because the magnitude and frequency of these large events remains unknown, their contribution to seepage emissions remains unquantified.

3.4.4.6 Currents

As a bubble or bubble plume rises, it is advected by currents, with the plume tilt being less for faster rising bubble plumes. But currents do more than tilt the bubble plumes, they also enhance detrainment and entrainment of bubbles out of and into the plume. Leifer et al. (2009a) observed smaller bubbles to the downcurrent side of a megaseep bubble plume, with detritus sinking to the downcurrent side, suggesting current-induced detrainment. The process of detrainment and entrainment implies a diminishing of bubble plume processes, both lessening of the upwelling flow through vertical momentum exchange with the surrounding ocean and through decreasing the plume fluid's enrichment of dissolved methane. To date, little is known about the interaction of bubble plumes and currents.

In a lab study, Socolofsky et al. (2002) observed a bifurcation of a combined bubble oil droplet plume. A numerical model (Johansen 2003) based on the deep spill release experiment (Johansen et al. (2003) showed that a blowout plume of oil and gas can bifurcate and that the lower buoyancy, oilier plume can become trapped in a midwater column. Such bifurcation is not observed in the field, although in weak bubble plumes, oilier bubbles are observed to surface farther downcurrent than less oily bubbles. Leifer and Boles (2005) did observe tiny oil droplets drifting horizontally near the seabed of Shane Seep. One possible explanation is that near the seabed, the upwelling flow is largely undeveloped allowing the droplets to drift out of the bubble plume; however, farther up the upwelling flow entrains the oil droplets, thus preventing

bifurcation. Currents also almost certainly affect turbulence and mixing in the bubble plume and between the bubble plume and surrounding fluid.

3.4.4.7 Stratification

Where the bubble plume encounters stratification, such as at the thermocline, plume fluid detrainment can occur, depositing the upwelled fluid and its contents (Leifer et al. 2009a). Although Leifer and Judd (2002) proposed that a layer of methane and scatterers associated with seepage were due to bubble dissolution, plume detrainment at the thermocline is a more likely cause. This mechanism was used to explain a “pooling” of methane at the thermocline in the Gulf of Mexico over-seepage from 550-m deep (Solomon et al. 2009). The effect of stratification on rising oil and bubbles may play an important role where rising oil becomes trapped in the middle of the water column Liefer and Wilson (2004).

The density of gas bubbles is far less than that of water, and as a result, bubbles rise at a speed that is largely insensitive to the water density (Clift et al. 1978). Where bubbles rise in a plume, they transport fluid in the upwelling flow (Leifer et al. 2009a). Where the ocean is stratified, the buoyancy of the bubbles lifts the fluid against the stratification. The stratification leads to increased loss of fluid momentum from the bubble plume to the surrounding ocean. The greater the density difference between the plume water and surrounding water (which corresponds to greater vertical transport of water), the greater the loss of plume fluid to the surrounding water.

The above description applies to a gradual vertical stratification of water. Where the stratification is sharp, that is, at the thermocline, or more precisely, the pycnocline, massive plume detrainment occurs, forming horizontal intrusions (McDougall 1978; Aseda and Imberger 1993; Leifer et al. 2009a). These intrusions may be neutrally buoyant, sink slowly, or sink rapidly (Fanneløp and Sjøen 1980). For the intrusion to achieve neutral buoyancy, it must mix sufficiently with the surrounding fluid. Most the studies of stratification and bubble plumes have been small-scale laboratory studies; however, Leifer et al. (2009a) noted a layer enriched in cooler water at the base of the thermocline from a megaseep in the Coal Oil Point seep field for a bubble plume from 45 m deep. A similar explanation was invoked to explain elevated methane levels observed at the base of the thermocline or mixed layer in the Gulf of Mexico for seep plumes rising from 550 m deep (Solomon et al. 2009). Thus, oil droplets entrained in a seep plume will be detrained into a layer at the base of the stratified layer. Depending on their density, these oil droplets may rise slowly, sink, or be trapped in the layer, drifting with the currents.

3.4.4.8 Oil and Tar Emissions

Although oil emission from most marine seeps is reported to arise as oily bubbles, in some locations, oil escapes the seabed without gas. At Jackpot seep, tar whips a few centimeters long ([Figure 3.8](#)) remain attached to the seabed for a period of minutes or longer before detaching and drifting slowly toward the sea surface (Leifer et al. 2009a). However, here the driving force must be gas pressure, as seepage elsewhere at the site escapes as both gas and oil. The flux was measured using an oil/gas separator at the main vent of Jackpot seep (34°24.175'N, 119°52.670'W) and yielded a flux of approximately 100 ml per hour of oil and approximately 90 l per hour of gas, with high variability and unsteadiness in the oil emissions. Mikolaj and

Ampaya (1973) and Leifer and Wilson (2007) found a tidal variation in oil and gas emissions from an abandoned oil well offshore of Summerland. A larger tidal influence on oil emissions was found than for gas.



Figure 3.8. Tar whips a few centimeters long at Jackpot seep and tar paddy.

(Source: Leifer 2009).

Elsewhere at Jackpot seep, bubbles escape from layered tar plains tens of meters in diameter. The mechanism of formation of these tar structures is unknown. A similar tar structure was reported to have developed near Tonya seep (Anderson 2009), a megaseep that first appeared several years ago as a pit a meter or so in diameter with emissions that were only gas. Several years later, emissions escaped from a larger area and were oily.

Significantly larger tar whips (to a meter) have been reported escaping from tar mounds from seepage offshore of Point Conception, to the south and to the west, stretching for about 20 to 25 km along the coast. Extensive tar mounds and tar plains have been mapped covering an area of about 8 km² in patches as large as a square kilometer within which are many overlapping tar emission sites. Seep gas has been observed escaping at various locations, and bubbles have been seen trapped in the tar. Thus, the driving force for tar emissions likely is gas pressure, although geologic pressure also could play a role. Emission rates are unknown. (Lorenson et al. 2009 in prep).

3.4.5. Sea Surface Transport and Chemistry

3.4.5.1 Overview

Understanding the fate of oil in the environment is of widespread interest to scientists, regulatory agencies, and industry. Concerns include oil spill mitigation and remediation, resource exploitation planning, and transportation planning (Reed et al. 1995). For example, effective oil spill models improve the safety of exploitation in the vicinity of sensitive habitats in the case of accidental spills. Similarly, planning for shipping routes for petroleum products may consider the fate of accidental spills under prevailing wind and current conditions.

At the sea surface, the oil forms slicks that drift under the effects of wind and currents and the slicks evolve chemically due to various processes such as evaporation and photolysis (see [Figure 3.9](#)). All processes other than drift are termed “weathering” because they transform the petroleum into a form with different chemical and physical characteristics (Coleman et al. 2003).

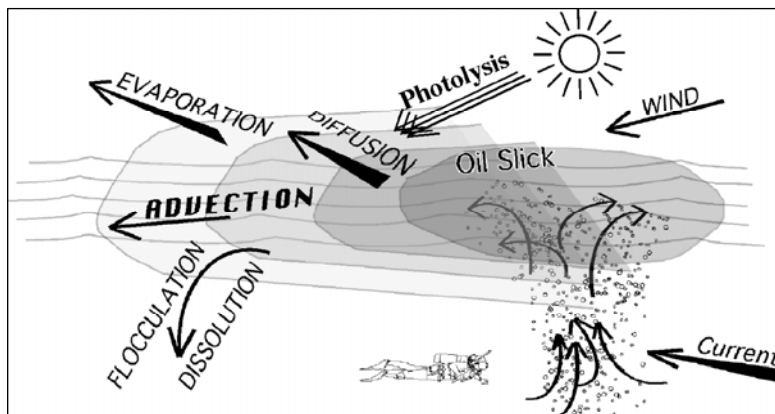

Figure 3.9. Schematic of important initial oil slick evolution processes with a time scale of 1 to several days.

From Leifer et al. 2006b.

Several processes occur during the initial period of oil slick evolution, which are illustrated schematically in [Figure 3.9](#), and are discussed below. These processes apply to both oil spills and seep oil. There are synergies between the processes; for example, photolysis of larger components creates smaller, more volatile components that evaporate at faster rates. Other processes, such as microbial degradation, take longer to develop than the time the oil slick typically remains at the sea surface. However, tar balls, discussed in the following section, can persist at the sea surface for a far longer time.

California produces intermediate to heavy crude oils from offshore reservoirs, with light crude oils being produced from onshore reservoirs. Ninety-six percent of offshore production is intermediate grade crude, with sulfur content from 1 to 2 percent (Jokuty et al. 1999; Sheridan 2006). These heavier crude oils behave differently than oil spills of lighter crude oils or distillate products.

3.4.5.2 Evaporation

Evaporation occurs on a fast time scale (hours to a day) and can be the most important process in terms of mass balance, with an intermediate crude losing up to 40 percent of its volatile components and a heavy crude losing 10 percent. Fingas (1996) showed that boundary layer regulation is minimal, and thus can be calculated from distillation data. In the Coal Oil Point seep field, crude oil has a flashpoint of 10°C when it comes fresh from platform Holly; it increases to 95°C after evaporation of 24 percent of its volatile components, comparable to the flash point of typical seep oil slicks. Its dynamic viscosity increases dramatically as it evaporates, from 3,314 to 304,000 mPa, for a 22 percent loss of volatiles.

Although loss rates of volatiles for Coal Oil seep field oil have not been measured, it has been observed that oil from the seeps begins to have a waxy appearance within a period of a few hours. This tends to occur a few hours after the marine layer breaks up and solar insolation reaches the sea surface. However, the breakup of the marine layer is also typically accompanied by increased winds and warming atmospheric temperatures (Leifer 2009).

3.4.5.3 Spreading

Spreading also occurs on a fast time-scale (minutes to hours) and is important for understanding the motion and spatial distribution of oil. Spreading is driven by gravity and retarded by viscosity and drag of the underlying water and air. Initial gravitational spreading can be on the order of 50 cm/s (Lehr and Simecek-Beatty 2000). In a slick-tracking experiment, Leifer et al. (2005) observed the slick moving perpendicular to the currents and winds, which they interpreted as caused by spreading. As the oil spreads, it thins, decreasing the driving force and thus the rate of spreading. Where oil is constrained by other forces, such as Langmuir circulation, current shear, or an oil boom, a thin sheen spreads out against the compression motion. Such sheens are commonly observed in the Coal Oil Point seep field.

3.4.5.4 Advection

Wind and currents drive the advection of oil. The drift speed of the oil is generally simulated as 3.5 percent of the 10 m wind speed (Reed et al. 1999). However, the driving force is the wind stress at the sea surface, which depends on the momentum transferred from wind above to the sea surface. The wind profile is described by a logarithm, which depends on the surface roughness elements, which in turn depend on the sea state, as well as latent heat (Hanna et al. 1982). There is extensive literature indicating that the wind stress varies with many factors (Smith et al. 1996; Myrhaug and Holmedal 2008). As a result, the wind speed parameterization is likely inappropriate for many oceanographic and meteorological conditions.

In a slick-tracking experiment, Leifer et al. (2005) were unable to predict the trajectory of natural seep oil from Shane seep in the Coal Oil Point seep field using the measured currents and a 3.5 percent wind speed relationship, which moved the oil in the exact opposite direction of its actual drift. Instead, accurate prediction of the slick trajectory was achieved by assuming either a wind drift of 12 percent of the wind speed or a current drift of only 30 percent of the speed of the current. This slick-tracking study illustrated the need for field measurements to improve the accuracy of oil slick models.

3.4.5.5 Miscellaneous Processes (Photolysis, Emulsification)

Weathering of the oil at the surface or in the upper water column occurs because of photolysis or photo-oxidation, which leads to more complex molecules that may be less volatile, more water soluble and possibly more toxic. Photo-oxidation also can result in higher molecular-weight products when chemical intermediates aid in the formation of tar and gum residues. Photo-oxidation of natural seep oil slicks has not been studied in the field.

Emulsification is the process of formation of various states of water in oil, up to 60 to 85 percent of the volume of the oil. Emulsions have significantly different physical processes than the original oil, increasing the viscosity by many orders of magnitude, creating a material that is no longer fluid (Coleman et al. 2003). One common mechanism for forming emulsions is from breaking waves. Emulsions also are observed to form in convergence zones associated with seep outwelling flows in the Coal Oil Point seep field, but these have not been studied (Leifer, unpublished observations).

3.4.5.6 Sinking

As the volatile components of oil evaporate or dissociate, the density increases, which may lead to the oil sinking. Although poorly documented, sinking appears to play a critical role in the fate of oil emissions from the Coal Oil Point seep field. Results from detailed beach-tar surveys over the last year (Del Sontro et al. 2007) suggest that on the order 1 percent or less of this oil actually reaches the shoreline, implying that up to 99 percent or more sinks into the water column before reaching the Santa Barbara shoreline or is transported out of the Santa Barbara Channel. The amount that sinks rather than forming persistent tar balls (which then may exit the channel) compared to transient stranding on Santa Barbara area beaches is unknown. However, the lack of significant permanent tar stranding on SB Channel area beaches (Del Sontro et al. 2007), suggests the fate of much of this tar is eventual seabed deposition. An extensive “plume” of deposited petroleum hydrocarbons was identified in sediment stretching tens of kilometers to the west of the Coal Oil Point seep field, indicating the importance of oil submergence after weathering (Farwell et al. 2009).

A slick-tracking experiment in May 2006 showed the following typical processes for emission from natural seeps (Leifer, unpublished observations). Fresh oil rises on bubbles to the surface and spreads into bordering convergence zones. There, oil likely accumulates overnight (when surface conditions are calm) and is drawn off into long, thick brown slicks stretching many kilometers, generally parallel to the shoreline. During the following day, morning winds were very weak (approximately 2 m/s) from the west-southwest and then the west. The winds compressed the slicks while pushing them shoreward. By late afternoon, weathering (sun and wind) caused the narrow, thick brown slicks (several millimeters) to form pancakes of brown mousse which then began sinking, much of it several hundred meters offshore. These slicks were tracked for several kilometers by seeding them with hollow glass microballoons. After sinking, the oil’s fate remains unknown—it may disperse into a plume throughout the water column, be deposited into a seabed layer or into the sediment, or be transported onto area beaches.

3.4.6 Tar Processes

3.4.6.1 Overview

Coastal tar accumulation is common on many California beaches resulting from chronic oil emissions from natural oil seeps (Hartman and Hammond 1981). Tar accumulation at Coal Oil Point is highly variable (Del Sontro et al. 2007) and results from numerous factors including transport, weathering, and source emission. As a result, the variability in tar accumulation incorporates most processes affecting petroleum hydrocarbons in the environment. Yet, very few studies have investigated seep-related beach tar accumulation, even though the National Oceanic and Atmospheric Administration listed this type of research as number one priority in long-term oil weathering research (Mearns and Simecek-Beatty 2003). This may relate to the low toxicity of tar if it is not ingested. Where tar balls are fresh, they still retain significant volatile and hence toxic components; however, with age (and tar balls are highly persistent) tar balls do not present a significant health hazard (Goodman 2003).

3.4.6.2 Beach Accumulation

Tar accumulation at Coal Oil Point (COP) is larger by several orders of magnitude than at any other location on the North American Pacific Coast (Allen et al. 1970). A few studies have characterized California beach tar in an effort to identify sources (Hartman and Hammond 1981; Hostettler et al. 2004). Hartman and Hammond (1981) estimated that 55 percent of Santa Monica beach tar was from the COP seep field, 250 km distant after an estimated drift time of 10 days to 4 weeks. They also observed that periods of heaviest tar accumulation were in the spring and summer, which they proposed was explained best by transport south and east toward Santa Monica Bay by the southerly California Current. They proposed that during winter months, the northerly Davidson Current surfaces at the western boundary of the Santa Barbara Channel and may transport COP seep oil north.

In the only spatially and temporally detailed study of tar accumulation on coastal beaches, Del Sontro et al. (2007) found a significant seasonal variation in tar accumulation, with summer tar accumulations an order of magnitude higher than winter ones. On the basis of multiple regression analyses between environmental data and tar accumulation, it was found that 38 percent of tar variability is explained by winds to the east and north advecting tar onshore and low swell-height inhibiting slick dispersion. Low swell also reduces the alongshore current, decreasing the residence time of the tar on the beach, although the primary factor affecting residence time was found to be tide height, with stranding of the tar ball on 1 day and the flood tide removing tar from the portions of the beach that the water reaches on subsequent days.

Although winter tar accumulation was significantly less than summer accumulation, Del Sontro et al. (2007) observed a large tar accumulation event during the winter (27 Feb 2005), which was large even by summer accumulation levels. Data did not allow for identification of a mechanism, although given the infrequency of similar conditions, transport processes are unlikely, thus the event most likely related to an increase in oil emissions from the seep field.

Because there was no tar accumulation in the sandy portions of the beach, the tar must have incorporated these coarse-grained materials resulting in a denser matrix that was returned to the sea during subsequent high-tide scouring. Beyond accumulation and transport, and possible burial in marine sediments, little has been published about the evolutionary processes affecting tar balls, both on land or at sea (Mearns and Simecek-Beatty 2003).

3.4.7 Oil and Gas Seep Ecology

3.4.7.1 Microbial

Chronic marine seeps are sources of significant amounts of hydrocarbon deposited into the oceans (see also [Chapter 2](#) for more geological information on the seeps). Core sampling at Coal Oil Point by LaMontagne et al. (2004) is the first study to show that integrated bacterial diversity and richness are inversely related to the hydrocarbon content of the sediments in natural seeps. The gamma-Proteobacteria and Holophaga are oil-sensitive. Hydrocarbons may control microbial community structure either directly by affecting sediment quality or indirectly by affecting the redox potential of the sediments.

3.4.7.2 Higher Trophic Levels

Roy et al. (2003) used laboratory experiments with the horny turbot (*Pleuronichthys verticalis*) to demonstrate the effects of hydrocarbon exposure from sediments of natural oil seeps. On the basis of 7-day laboratory exposures to a gradient (0 to 105 $\mu\text{g/g}$ PAHs) of natural hydrocarbon containing sediment from Coal Oil Point, the fish exhibited a number of effects. Plasma estradiol reduction was seen in all male and female fish at all exposure levels. Levels of hepatic DNA damage increase linearly with increasing exposure concentrations of the high molecular weight PAHs, though the concentrations of biliary tract fluorescent aromatic compounds were not linearly related. The experiment indicates that acute sediment-only exposure of flatfish to PAHs natural to the waters causes alterations in organism biochemistry.

3.5 SUMMARY AND DATA GAPS

The chemical oceanography of the Southern Study Area is strongly influenced by the California Current regime in the surface waters, and a broad suboxic zone that impinges on the continental slope at depth. Seasonal and spatially-variable upwelling strongly impacts the distribution of nutrients and primary productivity. Chemicals found in this region may come from atmospheric deposition, runoff from adjacent land surfaces, waste-water discharges, sediment flux, other water masses, or may be produced in situ in these productive waters.

The California Current System is characterized by upwelling. The biologic process of primary production is often prolific in the upwelling regime of the California Current System. An understanding of this process influences the ability to predict the contribution of phytoplankton to carbon cycling, the development and persistence of harmful algal blooms, and the ability to use remote sensing to identify specific phytoplankton taxa which is important for biogeochemistry. Periodically, upwelling can be hindered by El Niño/La Niña events. Changes in ocean circulation result in changes in regional surface water temperature and the weak or no upwelling conditions strongly impact primary production.

While the waters of the inner shelf in the study region have been thoroughly explored, the outer shelf and basins of the study region have been remarkably poorly explored, which is a significant data gap. Recent discoveries of massive hydrate mounds, pockmarks, asphalt volcanoes and chemosynthetic communities in the study region underscore this point. Autonomous underwater vehicle (AUV)-based imaging surveys, along with submarine and remotely operative vehicle (ROV)-based exploration may be able to reveal the distribution of cold seeps, the density and distribution of chemosynthetic communities, and identify chemical distributions (methane, H_2S , O_2 , etc.) associated with specific benthic features and regions.

With the exception of the well-studied Coal Oil Point seeps, the literature concerning the locations and nature of offshore seepage for the study regions is insufficient by modern standards. Data gaps include the lack of precise geographic coordinates, flux estimates, as well a lack of molecular and isotopic compositional data that could be used to track sources of suspected contamination. A concerted effort to positively identify and precisely locate seeps, and to collect oil and gas samples therefrom, would provide several benefits. First, it would facilitate the identification of spills versus natural slicks, either remotely (DiGiacomo et al. 2004; Serra-Sogas et al. 2008a; Serra-Sogas et al. 2008b) or through chemical fingerprinting (Farwell

et al. 2009). Second, this effort would further enable assessment of the impacts of chronic inputs of oil and gas to the study region. Regions that are particularly poorly documented include the Santa Maria Basin and the offshore basins throughout the study region.

Methane is a potent greenhouse gas, having a global warming potential approximately 25-fold greater than that of CO₂ when averaged over the lifetime of the molecule. This gas may come under increasing regulation, such as through carbon trading credits, and may begin to play a more important role in environmental impact assessments. Distinguishing natural versus industrial emissions and understanding the fate of submarine emissions from natural or production operations may prove beneficial to the BOEMRE. This would also provide important information about the biogeochemistry of methane in the sea. Significant data gaps include the lack of a regional methane budget, which includes gaps such as the magnitude and spatial distribution of sources, apportionment of loss processes (atmospheric evasion, microbial oxidation, advection out of the study region), and distribution maps.

There are significant data gaps concerning the molecular and isotopic composition of natural chemicals and pollutants in the Southern Study Area. These gaps are fundamentally tied to emerging technologies that promise to better identify and/or quantify trace pollutants and enable the deconvolution of anthropogenic and natural sources. Such tools include (1) Fourier Transform Ion Cyclotron Resonance Mass Spectrometry (FT-ICR-MS) for high molecular weight organic compounds; (2) Comprehensive Two-Dimensional Gas Chromatography–Time of Flight Mass Spectrometry (GC×GC-ToF-MS) for volatile compounds; and (3) Inductively Coupled Plasma Multi-Collector Mass Spectrometry (ICP-MC-MS) for trace metals and their isotopes. A more detailed understanding of organic and inorganic chemical distributions, through these and other emerging technologies, will narrow these data gaps through improved chemical and isotopic sourcing of chemicals in the southern study area.

The weathering patterns of complex organic materials such as well cuttings, crude oil, or components of produced water, remain only partially understood. Key data gaps include the pathways by which many compounds are broken down, and the toxicity potential of numerous intermediates present at low concentration. Additional data gaps include the fate of such compounds, and their interactions with naturally-occurring compounds and organisms present in the study region.

The potential for formation of dead zones in the waters of the study region is remote but also important. This region contains a strong suboxic zone in the intermediate waters, and the potential for oxygen deprivation in the surface waters has not been seriously considered. The geologic record suggests that waters of the Santa Barbara Basin may have become sulfidic in the past (Hinrichs et al. 2003), albeit when sea level was lower and basin circulation more restricted.

Hydrogen sulfide gas and its ionic forms—sulfide and bisulfide—are abundant in many offshore oil and gas reservoirs and are toxic to most organisms. The fate of sulfide released into the ocean as a result of offshore operations has not been fully considered. Furthermore, the fate and impacts of organosulfur compounds that are abundant in many native oils of the region have not been thoroughly investigated and serve as a significant data gap.

3.6 LIST OF LITERATURE CITED—CHEMICAL OCEANOGRAPHY

- Ackerman, D. and K. Schiff. 2003. Modeling storm water mass emissions to the Southern California Bight. *Journal of Environmental Engineering-Asce* 129(4):308-317.
- Ahn, J., S. Grant, C. Surbeck, P. Digiacomio, N. Nezlin and S. Jiang. 2005. Coastal water quality impact of stormwater runoff from an urban watershed in Southern California. *Environmental Science & Technology* 39(16):5940-5953.
- Allredge, A.L. and M.W. Silver. 1988. Characteristics, dynamics and significance of marine snow. *Progress in Oceanography* (1):51-82.
- Allen, A.A., R.S. Schleuter and P.G. Mikolaj. 1970. Natural oil seepage at Coal Oil Point, Santa Barbara, California. *Science* 170:974-977.
- Anderson, C., D. Siegel, M. Brzezinski, and N. Guillocheau. 2008. Controls on temporal patterns in phytoplankton community structure in the Santa Barbara Channel, California. *Journal of Geophysical Research* 113(C4):1-16.
- Arnold, R. 1907. Geology and oil resources of the Summerland District, Santa Barbara County, CA, USA. *Geological Service Bulletin* 321. 93 pp.
- Aseda, T. and J.T. Imberger. 1993. Structure of bubble plumes in linearly stratified environments. *Journal of Fluid Mechanics* 249:35-57.
- Barbeau, K. 2006. Photochemistry of organic iron (III) complexing ligands in oceanic systems. *Photochemistry and Photobiology* 82(6):1505-1516.
- Bay, S., B. Jones, K. Schiff and L. Washburn. 2003. Water quality impacts of stormwater discharges to Santa Monica Bay. *Marine Environmental Research* 56(1-2):205-223.
- Berelson, W.M., K. Johnson, K. Coale, and H.C. Li. 2002. Organic matter diagenesis in the sediments of the San Pedro Shelf along a transect affected by sewage effluent. *Continental Shelf Research* 22(6-7):1101-1115.
- Berelson, W.M., M. Prokopenko, F.J. Sansone, A.W. Graham, J. McManus and J.M. Bernhard. 2005. Anaerobic diagenesis of silica and carbon in continental margin sediments: Discrete zones of TCO₂ production. *Geochimica et Cosmochimica Acta* 69(19):4611-4629.
- Blanchard, D.C. and L.D. Syzdek. 1977. Production of air bubbles of a specified size. *Chemical Engineering Science* 32(9):1109-1112.
- Boetius, A. and E. Suess. 2004. Hydrate Ridge: A natural laboratory for the study of microbial life fueled by methane from near-surface gas hydrates. *Chemical Geology* 205(3-4):291-310.
- Bograd, S.J., T.K. Chereskin and D. Roemmich. 2001. Transport of mass, heat, salt, and nutrients in the Southern California Current System: Annual cycle and interannual variability. *Journal of Geophysical Research-Oceans* 106(C5):9255-9275.

- Boles, J., J. Clark, I. Leifer and L. Washburn. 2001. Temporal variation in natural methane seep rate due to tides, Coal Oil Point area, California. *Journal of Geophysical Research-Oceans* 106(C11):27077-27086.
- Boles, J., P. Eichhubl, G. Garven and J. Chen. 2004. Evolution of a hydrocarbon migration pathway along basin-bounding faults: Evidence from fault cement. *AAPG Bulletin* 88(7): 947-970.
- Bonini, M. 2007. Interrelations of mud volcanism, fluid venting, and thrust-anticline folding: Examples from the external northern Apennines (Emilia-Romagna, Italy). *Journal of Geophysical Research* 112(B8): B08413, doi: 10.1029/2006JB004859.
- Boudreau, B.P., C. Algar, B.D. Johnson, I. Croudace, A. Reed, Y. Furukawa, K.M. Dorgan, P.A. Jumars, A.S. Grader, and B.S. Gardiner. 2005. Bubble growth and rise in soft sediments. *Geology* 33(6):517-520.
- Bradley, Eliza S., I. Leifer and D.A. Roberts. 2009. Atmospheric long-term monitoring of temporal trends in seep field emissions. *Atmospheric Environments*. Submitted Feb 2010.
- Bray, N.A., A. Keyes and W.M.L. Morawitz. 1999. The California Current System in the Southern California Bight and the Santa Barbara Channel. *Journal of Geophysical Research* 104(C4):7695-7714.
- Bronk, D.A., J.H. See, P. Bradley and L. Killberg. 2007. DON as a source of bioavailable nitrogen for phytoplankton. *Biogeosciences* 4(3):283-296.
- Bronk, D.A. and B.B. Ward. 2005. Inorganic and organic nitrogen cycling in the Southern California Bight. *Deep-Sea Research Part I-Oceanographic Research Papers* 52(12):2285-2300.
- Bruland, K.W., E.L. Rue and G.J. Smith. 2001. Iron and macronutrients in California coastal upwelling regimes: Implications for diatom blooms. *Limnology and Oceanography* 46(7):1661-1674.
- California Division of Oil and Gas. 1991. Southern, Central and Offshore California. Sacramento: California Division of Oil and Gas.
- Chavez, F.P., J.T. Pennington, C.G. Castro, J.P. Ryan, R.P. Michisaki, B. Schlining, P. Walz, K.R. Buck, A. Mcfadyen and C.A. Collins. 2002. Biological and chemical consequences of the 1997-1998 El Niño in central California waters. *Progress in Oceanography* 54(1-4):205-232.
- Childress, J.J. and B.A. Seibel. 1998. Life at stable low oxygen levels: Adaptations of animals to oceanic oxygen minimum layers. *Journal of Experimental Biology* 201(8):1223-1232.

- Clark, J.F., L. Washburn and K. Schwager. 2009. Variability of gas composition and flux intensity in natural marine seeps. *Geo-Mar Lett* (2010) 30: 379-388, doi: 10.1007/s00367-009-0167-1.
- Clift, R., J.R. Grace and M.E. Weber. 1978. Bubbles, drops, and particles. New York: Academic Press. 380 pp.
- Coleman, J., J. Baker, C. Cooper, M. Fingas, G. Hunt, K. Kvenvolden, K. Michel, J. Michel, J. Mcdowell, J. Phinney, R. Pond, L. Rabalais, L. Roesner and R.B. Spies. 2003. Oil in the sea III: Inputs, fates, and effects. Washington, DC: National Academies Press.
- Coleman, J., J. Baker, C. Cooper, M. Fingas, G. Hunt, K. Kvenvolden, K. Michel, J. Michel, J. Mcdowell, J. Phinney, R. Pond, N. Rabalais, L. Roesner and R.B. Spies. 2005. Oil in the sea III: Inputs, fates, and effects. Washington, DC: National Academies Press.
- Crain, W.E., W.E. Mero and D. Patterson. 1985. Geology of the Point Arguello discovery. *AAPG Bulletin* 69(4):537-545.
- Dailey, M.D., D.J. Reish and J.W. Anderson. 1993. Ecology of the Southern California Bight: A synthesis and interpretation. Berkeley, CA: University of California Press.
- Del Sontro, T., I. Leifer, B.P. Luyendyk and B.R. Broitman. 2007. Beach tar accumulation, transport mechanisms, and sources of variability at Coal Oil Point, California. *Marine Pollution Bulletin* 54(9):1461-1471.
- DiGiacomo, P.M., L. Washburn, B. Holt and B.H. Jones. 2004. Coastal pollution-hazards in Southern California observed by SAR imagery: Stormwater plumes, wastewater plumes, and natural hydrocarbon seeps. *Marine Pollution Bulletin* 49(11-12):1013-1024.
- Ding, H. and D.L. Valentine. 2008. Methanotrophic bacteria occupy benthic microbial mats in shallow marine hydrocarbon seeps, Coal Oil Point, California. *Journal of Geophysical Research-Biogeosciences* 113, G01015, doi:10.1029/2007JG000537.
- Eganhouse, R.P. and M.I. Venkatesan. 1993. Chemical Oceanography and Geochemistry. In: Dailey, M., D. Reish, and J. Anderson. Ecology of the Southern California Bight: A synthesis and interpretation. Berkeley, CA: University of California Press. 71-189 pp.
- Egland, E.T. 2000. Direct capture of gaseous emissions from a natural marine hydrocarbon seeps offshore of Coal Oil Point. M.A. Thesis, Univ. of California, Santa Barbara. 59 pp.
- Eichhubl, P. and J.R. Boles. 2000. Focused fluid flow along faults in the Monterey Formation, coastal California. *Geological Society of America Bulletin* 112(11):1667-1679.
- Eichhubl, P., H.G. Greene and N. Maher. 2002. Physiography of an active transpressive margin basin: High-resolution bathymetry of the Santa Barbara basin, Southern California continental borderland. *Marine Geology* 184(1-2):95-120.

- Esser, B.K. and A. Volpe. 2002. At-sea high-resolution trace element mapping: San Diego Bay and its plume in the adjacent coastal ocean. *Environmental Science & Technology* 36(13):2826-2832.
- Fanneløp, T.K., S. Hirschberg and J. Küffer. 1991. Surface current and recirculating cells generated by bubble curtains and jets. *Journal of Fluid Mechanics Digital Archive* 229629-657.
- Fanneløp, T.K. and K. Sjøen. 1980. Hydrodynamics of underwater blowouts. Jan. 14-16. In: AIAA 18th Aerospace Science Meeting, Pasadena, CA.
- Farwell, C., C.M. Reddy, E. Peacock, R.K. Nelson, L. Washburn and D.L. Valentine. 2009. Weathering and the fallout plume of heavy oil from strong petroleum seeps Near Coal Oil Point, CA. *Environmental Science & Technology* 43(10):3542-3548.
- Fingas, M. 1996. The evaporation of oil spills: Prediction of equations using distillation data. *Spill Science & Technology Bulletin* 3(4):191-192.
- Finkbeiner, T., C.A. Barton and M.D. Zoback. 1997. Relationships among in-situ stress, fractures and faults, and fluid flow: Monterey Formation, Santa Maria Basin, California. *AAPG Bulletin* 81(12):1975-1999.
- Fischer, P.J. 1977. Natural gas and oil seeps, Santa Barbara Basin, California. In: Everitts, D.J., R.G. Paul, C.F. Eaton, and E.E. Welday. *California offshore gas, oil, and tar seeps*. Sacramento: State of Calif. State Lands Comm. 1-62 pp.
- Fischer, P.J. 1978. Oil and tar seeps, Santa Barbara basin, California. State of California, State Lands Commission Staff Report. 1-62 pp.
- Fischer, P.J. and A.J. Stevenson. 1973. Natural hydrocarbon seeps, Santa Barbara basin. In: Fischer, P.J. *Santa Barbara Channel area revisited field trip guidebook*. Tulsa, Okla.: Am. Assoc. of Pet. Geol. 17-28 pp.
- Gong, C. and D.J. Hollander. 1999. Evidence for differential degradation of alkenones under contrasting bottom water oxygen conditions: Implication for paleotemperature reconstruction. *Geochimica et Cosmochimica Acta* 63(3-4):405-411.
- Goodman, R. 2003. Tar balls: The end state. *Spill Science & Technology Bulletin* 8(2):117-121.
- Gorsline, D.S., R.L. Kolpak, H.A. Karl, D.E. Drake, P. Fleischer, S.E. Thornton, J.R. Schwalbach and C.E. Savrda. 1984. *Studies of fine-grained sediment transport processes and products in the California Continental Borderland*. Published for the Geological Society by Blackwell Scientific Publications, Palo Alto, California.
- Grosbard, A. 2002. Treadwell wharf in the Summerland, California oil field: The first sea wells in petroleum exploration. *Oil Industry History* 3(1):1.

- Hales, B., L. Karp-Boss, A. Perlin and P.A. Wheeler. 2006. Oxygen production and carbon sequestration in an upwelling coastal margin. *Global Biogeochemical Cycles* 20, GB3001, doi:10.1029/2005GB002517.
- Hanna, S.R., G.A. Briggs and R.P. Hosker, Jr. 1982. *Handbook on Atmospheric Diffusion*. U.S. Dept. of Energy. 101 pp.
- Hartman, B. and D.E. Hammond. 1981. The use of carbon and sulfur isotopes as correlation parameters for the source identification of beach tar in the Southern California borderland. *Geochimica et Cosmochimica Acta* 45(3):309-319.
- Helly, J.J. and L.A. Levin. 2004. Global distribution of naturally occurring marine hypoxia on continental margins. *Deep-Sea Research Part I-Oceanographic Research Papers* 51(9):1159-1168.
- Hickey, B.M. 1992. Circulation over the Santa Monica-San Pedro Basin and Shelf. *Progress in Oceanography* 30:37-115.
- Hill, T.M., J.P. Kennett, D.L. Valentine, Z. Yang, C.M. Reddy, R.K. Nelson, R.J. Behl, C. Robert and L. Beaufort. 2006. Climatically driven emissions of hydrocarbons from marine sediments during deglaciation. *Proceedings of the National Academy of Sciences of the United States of America* 103(37):13570-13574.
- Hinrichs, K.U., L.R. Hmelo and S.P. Sylva. 2003. Molecular fossil record of elevated methane levels in late pleistocene coastal waters. *Science* 299(5610):1214-1217.
- Hornafius, J.S., D. Quigley and B.P. Luyendyk. 1999. The world's most spectacular marine hydrocarbon seeps (Coal Oil Point, Santa Barbara Channel, California): Quantification of emissions. *Journal of Geophysical Research-Oceans* 104(C9):20703-20711.
- Hostettler, F.D., R.J. Rosenbauer, T.D. Lorenson and J. Doughert. 2004. Geochemical characterization of tarballs on beaches along the California coast: Part I-Shallow seepage impacting the Santa Barbara Channel Islands, Santa Cruz, Santa Rosa and San Miguel. *Organic Geochemistry* 35:725-746.
- Hovland, M., J. Gardner and A. Judd. 2002. The significance of pockmarks to understanding fluid flow processes and geohazards. *Geofluids* 2:127-136.
- Huh, C.A. 1996. Fluxes and budgets of anthropogenic metals in the Santa Monica and San Pedro Basins off Los Angeles: Review and reassessment. *Science of the Total Environment* 179(1-3):47-60.
- Huh, C.A. and M.I. Venkatesan. 1998. Historical contamination in the Southern California Bight. Silver Spring, MD: Coastal Monitoring and Bioeffects Assessment Division, Office of Ocean Resources Conservation and Assessment, NOAA technical memorandum NOS ORCA; 129 U.S. Dept. of Commerce.

- Hunt, J.M. 1995. Petroleum geochemistry and geology. W.H. Freeman. New York, NY. 743 pp.
- Johansen, Ø. 2003. Development and verification of deep-water blowout models. *Marine Pollution Bulletin* 47(9-12):360-368.
- Johnson, B.D., B.P. Boudreau, B.S. Gardiner and R. Maass. 2002. Mechanical response of sediments to bubble growth. *Marine Geology* 187(3-4):347-363.
- Jokuty, P., S. Whiticar, Z. Wang, B. Fieldhouse and M. Fingas. 1999. A catalogue of crude oil and oil product properties for the Pacific Region. Ottawa, ON: Environment Canada. 264 pp.
- Jones, A.A., A.L. Sessions, B.J. Campbell, C. Li and D.L. Valentine. 2008. D/H ratios of fatty acids from marine particulate organic matter in the California Borderland Basins. *Organic Geochemistry* 39(5):485-500.
- Jones, B., J. Ohlmann, L. Washburn, E. Terrill and K. Farnsworth. 2007. River plume patterns and dynamics within the Southern California Bight. *Continental Shelf Research* 27:2427-2448.
- Jones, B.H., M.A. Noble and T.D. Dickey. 2002. Hydrographic and particle distributions over the Palos Verdes Continental Shelf: Spatial, seasonal and daily variability. *Continental Shelf Research* 22(6-7):945-965.
- Kalanetra, K.M., S.L. Huston and D.C. Nelson. 2004. Novel, attached, sulfur-oxidizing bacteria at shallow hydrothermal vents possess vacuoles not involved in respiratory nitrate accumulation. *Applied and Environmental Microbiology* 70(12):7487-7496.
- Kamerling, M., S. Horner and L. Thompson. 2003. The Monterey Formation at South Ellwood Field, Santa Barbara Channel, California. 19-24 May 2003. In: Society of Petroleum Engineers Western Regional/AAPG Pacific Section Joint Meeting, Long Beach, California. Pacific Section, AAPG, Bakersfield.
- Kessler, J.D., W.S. Reeburgh, D.L. Valentine, F.S. Kinnaman, E.T. Peltzer, P.G. Brewer, J. Southon and S.C. Tyler. 2008. A survey of methane isotope abundance (C-14, C-13, H-2) from five nearshore marine basins that reveals unusual radiocarbon levels in subsurface waters. *Journal of Geophysical Research-Oceans* 113(C12):C12021.
- Kimbrough, K.L., W.E. Johnson, G.G. Lauenstein, J.D. Christensen and D.A. Apeti. 2008. An assessment of two decades of contaminant monitoring in the nation's coastal zone. U.S. Dept. of Commerce, National Oceanic and Atmospheric Administration (NOAA) and National Centers for Coastal Ocean Science (NCCOS).
- King, A.L. and K. Barbeau. 2007. Evidence for phytoplankton iron limitation in the Southern California Current System. *Marine Ecology-Progress Series* 342:91-103.

- Kolpak, R. and D.E. Drake. 1985. Transport of clay is in the eastern part of the Santa Barbara Channel, California. *Geo-Marine Letters* 4(3-4):191-196.
- Kopf, A.J. 2002. Significance of mud volcanism. *Reviews of Geophysics* 40(2):1005, doi:10.1029/2000RG000093.
- Kuwabara, J.S., A. Van Geen, D.C. Mccorkle and J.M. Bernhard. 1999. Dissolved sulfide distributions in the water column and sediment pore waters of the Santa Barbara Basin. *Geochimica et Cosmochimica Acta* 63(15):2199-2209.
- Kvenvolden, K., F. Hostettler, P. Carlson, J. Rapp, C. Threlkeld and A. Warden. 1995. Ubiquitous tar balls with a California-source signature on the shorelines of Prince William Sound, Alaska. *Environmental Science & Technology* 29(10):2684-2694.
- Ladah, L.B. 2003. The shoaling of nutrient-enriched subsurface waters as a mechanism to sustain primary productivity off Central Baja California during El Niño winters. *Journal of Marine Systems* 42(3-4): 145-152.
- La Montagne, G., I. Leifer, S. Bergmann, L.C. Van De Werfhorst and P.A. Holden. 2004. Bacterial diversity in marine hydrocarbon-seep sediments. *Environmental Microbiology* 6(8):799-808.
- Lehr, W.J. and D. Simecek-Beatty. 2000. The relation of Langmuir circulation processes to the standard oil spill spreading, dispersion, and transport algorithms. *Spill Science & Technology Bulletin* 6(3-4):247-253.
- Leifer, I. 2009. Characteristics and scaling of bubble plumes from marine hydrocarbon seepage in the Coal Oil Point seep field. *Journal Geophysical Research*, doi, 10.1029/2009JC005844, in press. Accepted 24 November 2009
- Leifer, I. and J. Boles. 2005. Measurement of marine hydrocarbon seep flow through fractured rock and unconsolidated sediment. *Marine and Petroleum Geology* 22(4):551-568.
- Leifer, I. and D. Culling. 2009. Formation of seep bubble plumes in the Coal Oil Point seep field. *Geo-Marine Letters* 30(3-4): 339-353.
- Leifer, I. and A. Judd. 2002. Oceanic methane layers: The hydrocarbon seep bubble deposition hypothesis. *Terra Nova* 14(6):417-424.
- Leifer, I. and I.R. MacDonald. 2003. Dynamics of the gas flux from shallow gas hydrate deposits: Interaction between oily hydrate bubbles and the oceanic environment. *Earth and Planetary Science Letters* 210:411-424.
- Leifer, I. and R. Patro. 2002. The bubble mechanism for methane transport from the shallow sea bed to the surface: A review and sensitivity study. *Continental Shelf Research* 22(16):2409-2428.

- Leifer, I. and K. Wilson. 2004. Quantified marine oil emissions with a video-monitored, oil seep-tent. *Marine Technology Society Journal* 38(3):44-53.
- Leifer, I. and K. Wilson. 2007. The tidal influence on oil and gas emissions from an abandoned oil well: Nearshore Summerland, California. *Marine Pollution Bulletin* 54(9):1495-1506.
- Leifer, I., J. Boles and B. Luyendyk. 2007. Measurement of Oil and Gas Emissions from a Marine Seep. New Energy Development and Technology (EDT-009) Working Paper. Berkeley, CA. Univ. of Calif. Energy Inst.
- Leifer, I., J.R. Boles, B.P. Luyendyk and J.F. Clark. 2004. Transient discharges from marine hydrocarbon seeps: Spatial and temporal variability. *Environmental Geology* 46(8):1038-1052.
- Leifer, I., J.F. Clark and R.F. Chen. 2000. Modifications of the local environment by natural marine hydrocarbon seeps. *Geophysical Research Letters* 27(22):3711-3714.
- Leifer, I., J. Clark and B. Luyendyk. 2006a. Simulation of a Subsurface Oil Spill by a Marine Hydrocarbon Seep. MMS Cooperative Agreement No. 14-35-01-00-CA-31063, Coastal Marine Institute, Marine Science Institute, University of California, Santa Barbara. 72 pp.
- Leifer, I., T. Del Sontro, B. Luyendyk and K. Broderick. 2005a. Time evolution of beach tar, oil slicks, and seeps in the Coal Oil Point seep field, Santa Barbara Channel, California. In: *Proceedings International Oil Spill Conference*, May 15-19, 2005, Miami, FL. EIS Digital Publishing, 14718A.
- Leifer, I., T. Del Sontro, B. Luyendyk and K. Broderick. 2005b. *Proceedings International Oil Spill Conference*, May 15-19, 2005.
- Leifer, I., H. Jeuthe, S.H. Gjørund and V. Johansen. 2009a. Engineered and natural marine seep, bubble-driven buoyancy flows. *Journal of Physical Oceanography* 39(12) p. 3071.
- Leifer, I., M. Kamerling, B.P. Luyendyk and D. Wilson. 2009b. Geologic control of natural marine seep hydrocarbon emissions, Coal Oil Point seep field, California. *Geo-Marine Letters* 30(3-4):331-338.
- Leifer, I., M. Kamerling, B. P. Luyendyk and D. Wilson. (In press). Spatial and temporal variations in marine seep field emissions on diurnal to decadal time scales and decameter to kilometer length scales. *Geochemistry, Geophysics, Geosystems*.
- Leifer, I., B. Luyendyk and K. Broderick. 2006b. Tracking an oil slick from multiple natural sources, Coal Oil Point, California. *Marine and Petroleum Geology* 23(5):621-630.
- Leifer, I., B.P. Luyendyk, J. Boles and J.F. Clark. 2006c. Natural marine seepage blowout: Contribution to atmospheric methane. *Global Biogeochemical Cycles* 20(GB3008), doi:10.1029/2005GB002668.

- Lemckert, C. 1993. Energetic bubble plumes in arbitrary stratification. *Journal of Hydraulic Engineering* 119:680-703, doi:10.1061/(ASCE)0733-9429(1993)119:6(680).
- Li, C., A.L. Sessions, F.S. Kinnaman and D.L. Valentine. (In press). Hydrogen-isotopic variability in lipids from Santa Barbara Basin sediments. *Geochimica et Cosmochimica Acta*.
- Lissner, A., Science Applications International Corporation (SAIC) and Marine Ecological Consultant (MEC) Analytical Systems. 1995. Monitoring assessment of long-term changes in biological communities in the Santa Maria Basin: Phase 3. 339 pp.
- Lissner, A.L., G.L. Taghon, D.R. Diener, S.C. Schroeter and J.D. Dixon. 1991. Recolonization of deep-water hard-substrate communities-potential impact from oil and gas development. *Ecological Applications* 1(3):258-267.
- Lorenson, T.D., F.D. Hostettler, R.J. Rosenbauer, K.E. Peters, J.A. Dougherty, K.A. Kvenvolden, C.E. Gutmacher, F.L. Wong and W.R. Normark. 2009. Natural offshore oil seepage and related tarball accumulation on the California coastline; Santa Barbara Channel and the southern Santa Maria Basin; source identification and inventory: U.S. Geological survey Open file Report 2009-1225 and MMS report 2009-030, 116 p and spreadsheets.
- Lynn, R., T. Baumgartner, J. Garcia, C.A. Collins, T. Hayward, K. Hyrenbach, A.W. Mantyla, T. Murphree, A. Shankle, F. Schwing, K. Sakuma and M. Tegner. 1998. The state of the California current, 1997-1998: Transition to El Niño conditions. *California Cooperative Oceanic Fisheries Investigations Reports* 39:25-49.
- Lyon, G., D. Petschauer and E. Stein. 2006. Effluent discharges to the Southern California Bight from large municipal wastewater treatment facilities in 2003 and 2004. Annual report: Southern California Coastal Water Research Project.
- Lyon, G.S. and E.D. Stein. 2008. Effluent discharges to the Southern California Bight from small municipal wastewater treatment facilities in 2005. Southern California Coastal Water Research project. 14 pp.
- MacDonald, I.R., I. Leifer, R. Sassen, P. Stine, R. Mitchell and N. Guinasso. 2002. Transfer of hydrocarbons from natural seeps to the water column and atmosphere. *Geofluids* 2:95-107.
- Matsunagi, G. and Y. Miyanaga. 1990. A field study on the characteristics of air bubble plume in a reservoir. *Journal of Hydroscience and Hydraulic Engineering* 8(2):65-77.
- Maurer, D., G. Robertson and T. Gerlinger. 1994. Trace-Metal in the Newport Submarine-Canyon, California and the adjacent shelf. *Water Environment Research* 66(2):110-118.
- McDougall, T. 1978. Bubble plumes in stratified environments. *Journal of Fluid Mechanics* 85:655-672.

- McManus, J., W.M. Berelson, G.P. Klinkhammer, T.E. Kilgore and D.E. Hammond. 1994. Remobilization of barium in continental-margin sediments. *Geochimica et Cosmochimica Acta* 58(22):4899-4907.
- McManus, J., W.M. Berelson, S. Severmann, R.L. Poulson, D.E. Hammond, G.P. Klinkhammer and C. Holm. 2006. Molybdenum and uranium geochemistry in continental margin sediments: Paleoproxy potential. *Geochimica et Cosmochimica Acta* 70(18):4643-4662.
- McQuay, E.L., M.E. Torres, R.W. Collier, C.A. Huh and J. McManus. 2008. Contribution of cold seep barite to the barium geochemical budget of a marginal basin. *Deep-Sea Research Part I-Oceanographic Research Papers* 55(6):801-811.
- Mearns, A.J. and D. Simecek-Beatty. 2003. Longer-term weathering-Research needs in perspective. *Spill Science and Technology Bulletin* 8:223-227.
- Mikolaj, P.G. and J.P. Ampaya. 1973. Tidal effects on the activity of natural submarine oil seeps. *Marine Technological Society Journal* 7:25-28.
- Milkov, A.V. 2000. Worldwide distribution of submarine mud volcanoes and associated gas hydrates. *Marine Geology* 167(1-2):29-42.
- Myrhaug, D. and L.E. Holmedal. 2008. Effects of wave age and air stability on whitecap coverage. *Coastal Engineering* 55(12):959-966.
- National Research Council (NRC). 2003. *Oil in the sea III: Inputs, fates, and effects*. Washington, D.C.: National Academy of Sciences. 265 pp.
- Naudts, L., J. Greinert, Y. Artemov, P. Staelens, J. Poort, P. Van Rensbergen and M. De Batist. 2006. Geological and morphological setting of 2778 methane seeps in the Dnepr paleo-delta, northwestern Black Sea. *Marine Geology* 227(3-4):177-199.
- Nezlin, N.P., P.M. DiGiacomo, D.W. Diehl, B.H. Jones, S.C. Johnson, M.J. Mengel, K.M. Reifel, J.A. Warrick and M.H. Wang. 2008. Stormwater plume detection by MODIS imagery in the Southern California coastal ocean. *Estuarine Coastal and Shelf Science* 80(1):141-152.
- Nezlin, N.P., P.M. DiGiacomo, E.D. Stein and D. Ackerman. 2005. Stormwater runoff plumes observed by SeaWiFS radiometer in the Southern California Bight. *Remote Sensing of Environment* 98(4):494-510.
- Nezlin, N.P., J.J. Oram, P.M. DiGiacomo and N. Gruber. 2004. Sub-seasonal to interannual variations of sea surface temperature, salinity, oxygen anomaly, and transmissivity in Santa Monica Bay, California from 1987 to 1997. *Continental Shelf Research* 24(10):1053-1082.
- Ocean Drilling, Program and W.D. Rose. 2000. *California Margin: Covering leg 167 of the cruises of the Drilling Vessel JOIDES Resolution, Acapulco, Mexico, to San Francisco, California, Sites 1010-1022, 20 April-16 June 1996* College Station, TX.

- Ocean Drilling Program, National Science Foundation, and Joint Oceanographic Institutions Incorporated. 1993. Santa Barbara basin covering Leg 146 of the Drilling Vessel Joides Resolution, Victoria, Canada to San Diego, California, site 893, 20 September-22 November 1992. In: Proceedings of the Ocean Drilling Program, College Station, Tex. Texas A & M, Ocean Drilling Program.
- Oguz, H.N. and A. Prosperetti. 1993. Dynamics of bubble growth and detachment from a needle. *Journal of Fluid Mechanics* 257:111-145.
- Olsen, D.J. 1982. Surface and subsurface geology of the Santa Barbara Goleta Metropolitan Area, Santa Barbara County, California. Oregon State University. 71 pp.
- Otero, M.P. and D.A. Siegel. 2004. Spatial and temporal characteristics of sediment plumes and phytoplankton blooms in the Santa Barbara Channel. *Deep-Sea Research Part II-Topical Studies in Oceanography* 51(10-11):1129-1149.
- Pearson, A. and T.I. Eglinton. 2000. The origin of n-alkanes in Santa Monica Basin surface sediment: A model based on compound-specific Delta C-14 and delta C-13 data. *Organic Geochemistry* 31(11):1103-1116.
- Pearson, A., A.P. McNichol, B.C. Benitez-Nelson, J.M. Hayes and T.I. Eglinton. 2001. Origins of lipid biomarkers in Santa Monica Basin surface sediment: A case study using compound-specific Delta C-14 analysis. *Geochimica et Cosmochimica Acta* 65(18):3123-3137.
- Peters, K.E., F.D. Hostettler, T.D. Lorenson and R.J. Rosenbauer. 2008. Families of Miocene Monterey crude oil, seep, and tarball samples, coastal California. *AAPG Bulletin* 92(9):1131-1152.
- Phillips, C. 2007. Sediment contaminant patterns within coastal areas of the Southern California Bight: Multivariate analyses of Bight '98 regional monitoring data. *Southern California Academy of Sciences Bulletin* 106(3):163-178.
- Prokopenko, M.G., D.E. Hammond, W.M. Berelson, J.M. Bernhard, L. Stott and R. Douglas. 2006. Nitrogen cycling in the sediments of Santa Barbara basin and Eastern Subtropical North Pacific: Nitrogen isotopes, diagenesis and possible chemosymbiosis between two lithotrophs (Thioploca and Anammox)-"riding on a glider." *Earth and Planetary Science Letters* 242(1-2):186-204.
- Quigley, D.C., J.S. Hornafius, B.P. Luyendyk, R.D. Francis, J. Clark and L. Washburn. 1999. Decrease in natural marine hydrocarbon seepage near Coal Oil Point, California, associated with offshore oil production. *Geology* 27(11):1047-1050.
- Reed, M., O.M. Aamo and P.S. Daling. 1995. Quantitative analysis of alternate oil spill response strategies using OSCAR. *Spill Science & Technology Bulletin* 2(1):67-74.

- Reed, M., Y. Johansen, P.J. Brandvik, P. Daling, A. Lewis, R. Fiocco, D. Mackay, and R. Prentki. 1999. Oil spill modeling towards the close of the 20th century: Overview of the state of the art. *Spill Science & Technology Bulletin* 5(1):3-16.
- Reimers, C.E., K.C. Ruttenberg, D.E. Canfield, M.B. Christiansen and J.B. Martin. 1996. Porewater pH and authigenic phases formed in the uppermost sediments of the Santa Barbara Basin. *Geochimica et Cosmochimica Acta* 60(21):4037-4057.
- Roland, L.A., M.D. McCarthy and T. Guilderson. 2008. Sources of molecularly uncharacterized organic carbon in sinking particles from three ocean basins: A coupled Delta C-14 and delta C-13 approach. *Marine Chemistry* 111(3-4):199-213.
- Roy, L.A., S. Steinert, S.M. Bay, D. Greenstein, Y. Sapozhnikova, O. Bawardi, I. Leifer and D. Schlenk. 2003. Biochemical effects of petroleum exposure in hornyhead turbot (*Pleuronichthys verticalis*) exposed to a gradient of sediments collected from a natural petroleum seep in CA, USA. *Aquatic Toxicology* 65(2):159-169.
- Santschi, P.H., L.S. Wen and L.D. Guo. 2001. Transport and diagenesis of trace metals and organic matter in Palos Verdes shelf sediments affected by a wastewater outfall. *Marine Chemistry* 73(2):153-171.
- Sanudo-Wilhelmy, S.A. and A.R. Flegal. 1994. Temporal variations in lead concentrations and isotopic composition in the Southern California Bight. *Geochimica et Cosmochimica Acta* 58(15):3315-3320.
- Schiff, K., J. Brown, D. Diehl and D. Greenstein. 2007. Extent and magnitude of copper contamination in marinas of the San Diego region, California, USA. *Marine Pollution Bulletin* 54(3):322-328.
- Schiff, K., D. Diehl and A. Valkirs. 2004. Copper emissions from antifouling paint on recreational vessels. *Marine Pollution Bulletin* 48 (3-4):371-377.
- Schiff, K.C., M. James Allen, E.Y. Zeng and S.M. Bay. 2000. Southern California. *Marine Pollution Bulletin* 41(1-6):76-93.
- Schnitzer, A., P.E. Miller, R.A. Schaffner, B.A. Stauffer, B.H. Jones, S.B. Weisberg, P.M. DiGiacomo, W.M. Berelson and D.A. Caron. 2007. Blooms of Pseudo-nitzschia and domoic acid in the San Pedro Channel and Los Angeles harbor areas of the Southern California Bight, 2003-2004. *Harmful Algae* 6(3):372-387.
- Science Applications International Corporation (SAIC). 1986. Assessment of long-term changes in the biological communities and the Santa Maria Basin and Western Santa Barbara Channel. U. S. Dept. of the Interior and Minerals Management Service (MMS). Contract number 14-12-0001-30032.

- Serra-Sogas, N., P. O'hara, R. Canessa, S. Bertazzon and M. Gavrilo. 2008a. Exploratory spatial analysis of illegal oil discharges detected off Canada's Pacific Coast. In: Year in evolutionary biology 2008. Blackwell Publishing, Oxford, England. Pp. 81-95.
- Serra-Sogas, N., P.D. O'hara, R. Canessa, P. Keller and R. Pelot. 2008b. Visualization of spatial patterns and temporal trends for aerial surveillance of illegal oil discharges in western Canadian marine waters. *Marine Pollution Bulletin* 56(5):825-833.
- Severmann, S., C.M. Johnson, B.L. Beard and J. McManus. 2006. The effect of early diagenesis on the Fe isotope compositions of porewaters and authigenic minerals in continental margin sediments. *Geochimica et Cosmochimica Acta* 70(8):2006-2022.
- Sheridan, M. 2006. California Crude oil production and imports. California Energy Commission and Fuels and Transportation Division. CEC-600-2006-006.
- Shipe, R.F. and M.A. Brzezinski. 2001. A time series study of silica production and flux in an eastern boundary region: Santa Barbara Basin, California. *Global Biogeochemical Cycles* 15(2):517-531.
- Shipe, R.F., A. Leinweber and N. Gruber. 2008. Abiotic controls of potentially harmful algal blooms in Santa Monica Bay, California. *Continental Shelf Research* 28(18):2584-2593.
- Shipe, R.F., U. Passow, M.A. Brzezinski, W.M. Graham, D.K. Pak, D.A. Siegel and A.L. Alldredge. 2002. Effects of the 1997–98 El Niño on seasonal variations in suspended and sinking particles in the Santa Barbara basin. *Progress in Oceanography* 54(1):105-127.
- Skognes, K. and Y. Johansen. 2004. Statmap--A 3-dimensional model for oil spill risk assessment. *Environmental Modelling & Software* 19(7-8):727-737.
- Slauenwhite, D.E. and B.D. Johnson. 1999. Bubble shattering: Differences in bubble formation in fresh water and seawater. *Journal of Geophysical Research* 104:3265-3275.
- Smith, S.D., C.W. Fairall, G.L. Geernaert and L. Hasse. 1996. Air-sea fluxes: 25 years of progress. *Boundary-Layer Meteorology* 78(3):247-290.
- Socolofsky, S.A., B.C. Crouse and E.E. Adams. 2002. Multi-phase plumes in uniform, stratified, and flowing environments. In: Shen, A.H.-D., M.H. Tang, K.-H. Wang, H.H. Shen, and C.K.L. Clark. *Environmental fluid mechanics: Theories and applications*. Reston, VA: American Society of Civil Engineers. Pp. 85-125.
- Solomon, E., M. Kastner, I.R. MacDonald and I. Leifer. 2009. Considerable methane fluxes to the atmosphere from hydrocarbon seeps in the Gulf of Mexico. *Nature* 2:561-565, doi:10.1038/ngeo574.
- Stein, E.D., L.L. Tiefenthaler and K.C. Schiff. 2008. Comparison of stormwater pollutant loading by land use type. Southern California Coastal Water Research Project.

- Thunell, R., C. Benitez-Nelson, R. Varela, Y. Astor and F. Muller-Karger. 2007. Particulate organic carbon fluxes along upwelling-dominated continental margins: Rates and mechanisms. *Global Biogeochemical Cycles* 21. GB1022, doi:10.1029/2006GB002793.
- Thunell, R.C. 1998. Particle fluxes in a coastal upwelling zone: Sediment trap results from Santa Barbara Basin, California. *Deep-Sea Research Part II-Topical Studies in Oceanography* 45(8-9):1863-1884.
- Thunell, R.C., W.S. Moore, J. Dymond and C.H. Pilskaln. 1994a. Elemental and isopic fluxes in the Southern California Bight-A time series sediment trap study in the San-Pedro Basin. *Journal of Geophysical Research-Oceans* 99(C1):875-889.
- Thunell, R.C., C.H. Pilskaln, E. Tappa and L.R. Sautter. 1994b. Temporal variability in sediment fluxes in the Sand Pedro Basin Southern California Bight. *Continental Shelf Research* 14(4):333-352.
- Torres, M.E., J. McManus and C.A. Huh. 2002. Fluid seepage along the San Clemente Fault scarp: Basin-wide impact on barium cycling. *Earth and Planetary Science Letters* 203(1):181-194.
- Turner, J.T. 2002. Zooplankton fecal pellets, marine snow and sinking phytoplankton blooms. *Aquatic Microbial Ecology* 27(1):57-102.
- U.S. Dept. of Commerce, National Oceanic and Atmospheric Administration (NOAA) and U.S. Environmental Protection Agency (EPA). 2007. 2002-2004 Southern California coastal marine fish contaminants survey. National Oceanic and Atmospheric Administration (NOAA) and U.S. Dept. of Commerce.
- U.S. Dept. of the Interior, Minerals Management Service (MMS). 2001. Delineation drilling activities in federal waters offshore Santa Barbara County, California. Draft Environmental Impact Statement. US Dept. of the Interior and Minerals Management Service (MMS) Pacific Outer Continental Shelf Region.
- Venkatesan, M.I., N. Chalaux, J.M. Bayona and E. Zeng. 1998. Butyltins in sediments from Santa Monica and San Pedro basins, California. *Environmental Pollution* 99(2):263-269.
- Venrick, E.L., F.M. H. Reid, A. Weinheimer, C.B. Lange and E.P. Dever. 2006. Temporal patterns of siliceous flux in the Santa Barbara Basin: The influence of North Pacific and local oceanographic processes. *California Cooperative Oceanic Fisheries Investigations Reports* 47:156-173.
- Villaescusa-Celaya, J.A., E.A. Gutierrez-Galindo and G. Flores-Munoz. 2000. Heavy metals in the fine fraction of coastal sediments from Baja California (Mexico) and California (USA). *Environmental Pollution* 108(3):453-462.
- Volpe, A.M. and B.K. Esser. 2002. Real-time ocean chemistry for improved biogeochemical observation in dynamic coastal environments. *Journal of Marine Systems* 36(1-2):51-74.

- Wang, Z. and S.A. Stout. 2007. Oil spill Environmental Forensics: Fingerprinting and source identification. Burling, MA: Elsevier. 554 pp.
- Ward, B.B. and D.A. Bronk. 2001. Net nitrogen uptake and DON release in surface waters: importance of trophic interactions implied from size fractionation experiments. *Marine Ecology-Progress Series* 219: 11-24.
- Warrick, J.A., L.A.K. Mertes, L. Washburn and D.A. Siegel. 2004. A conceptual model for river water and sediment dispersal in the Santa Barbara Channel, California. *Continental Shelf Research* 24(17):2029-2043.
- Warrick, J.A., L. Washburn, M.A. Brzezinski and D.A. Siegel. 2005. Nutrient contributions to the Santa Barbara Channel, California, from the ephemeral Santa Clara River. *Estuarine Coastal and Shelf Science* 62(4):559-574.
- Washburn, L., K.A. McClure, B.H. Jones and S.M. Bay. 2003. Spatial scales and evolution of stormwater plumes in Santa Monica Bay. *Marine Environmental Research* 56(1-2):103-125.
- Weeks, S.J., B. Currie, A. Bakun and K.R. Peard. 2004. Hydrogen sulphide eruptions in the Atlantic Ocean off southern Africa: Implications of a new view based on SeaWiFS satellite imagery. *Deep-Sea Research Part I-Oceanographic Research Papers* 51(2):153-172.
- Whelan, J., L. Eglinton, L. Cathles, III, S. Losh and H. Roberts. 2005. Surface and subsurface manifestations of gas movement through a N-S transect of the Gulf of Mexico. *Marine and Petroleum Geology* 22(4):479-497.
- Williams, P.M. 1986. Chemistry of the dissolved and particulate phases in the water-column. In: Eppley, R.W. Lecture notes on coastal and estuarine studies. Plankton dynamics of the Southern California Bight. Springer-Verlag, Berlin, Germany. Pp. 53-83.

4. PHYTOPLANKTON, ZOOPLANKTON, AND PELAGIC INVERTEBRATES

Planktonic organisms are integral parts of the marine food web. Phytoplankton forms the base of this food web by assimilating nutrients from oceanic currents and coastal inputs. This resource is consumed by zooplankton of all sizes, which are the major connection between the lower food web and larger species, primarily fishes. Much of this productivity is concentrated in the top several meters of water, where light and nutrients are abundant.

4.1 SPECIES COMPOSITION OF PLANKTON

Phytoplankton of the Southern California Bight consists of diatoms, ciliates, dinoflagellates and other types of pico- and nanoplankton. In the Santa Barbara Channel, which is located at the northern end of the Southern California Bight, the phytoplankton community fluctuates between mixed-assembly communities and single-group domination on a seasonal scale (Anderson et al. 2008). Diatoms, dinoflagellates, and other flagellates are responsible for these blooms. Anderson et al. (2008) found diatom-dominated communities are indicative of cold, high-biomass waters, while dinoflagellate-dominated communities are found when waters are warmer and contain lower biomass levels. Additionally, mixed-assembly communities were common during times of reduced stratification in the water column.

Southern California Bight zooplankton is dominated by several groups, primarily by copepods and euphausiids (Peterson et al. 2006; Lavaniegos and Ohman 2007). In late winter through the spring the community is dominated by large taxa, while smaller-sized taxa make up most of the community in the fall (Landry et al. 1994). This community sees a large increase in biomass during the spring season, when overall productivity is high. The spring increase in biomass is comprised mainly of calanoid copepods including *Calanus pacificus*, *Metridia pacifica* and *Pleuromamma borealis* (Rebstock 2001). This peak in productivity is followed by a gradual decrease in zooplankton biomass through the summer and early fall months (Roesler and Chelton 1987; McClatchie et al. 2008).

Euphausiids, commonly known as krill, are part of the zooplankton community throughout the world's oceans. These pelagic crustaceans are an important food source for larger species, perhaps most famously baleen whales. In the Southern Study Area, the euphausiid community is dominated by *Euphausia pacifica* and supports species from several other genera including *Nematoscelis* and *Thysanoessa* (Brinton and Townsend 2003). In waters off Southern California *E. pacifica* is a relatively short-lived species, surviving for about a year, and it exhibits two growing cohorts: a slowly maturing cohort present over the winter and a faster-growing cohort occurring in the summer (Brinton 1976; Siegel 2000). Sexual maturity is reached at 4 to 7 months of age (Brinton 1976) and major spawning events occur four to six times per year, usually commencing during the upwelling season (Siegel 2000). Eggs are released into the surface layer and remain there during development. Depending on the species, multiple developmental stages occur between the hatching naupliar stage, which is the first larval stage of crustaceans, and the juvenile phase. Many species in this group of organisms exhibit strong vertical migration patterns, migrating up to 600 meters over a diel cycle (Brinton 1967). Vertical

migration again depends on species and stage, but early stages need to spend a large amount of time in the surface layer feeding to meet energy requirements (Siegel 2000).

4.2 STANDING STOCK OF PLANKTON

Phytoplankton biomass can increase and decrease rapidly with changing conditions. Over a 12-year study (1984-1995), Hayward and Venrick (1998) found some fluctuation between years but an overall pattern of higher chlorophyll concentrations, and thus phytoplankton biomass, in spring months, primarily in April. This peak was followed by lower numbers found throughout the study area over the summer and autumn months. More variation was seen in the winter months leading into the spring blooms. These numbers were generated from the California Cooperative Oceanic Fisheries Investigations (CalCOFI) studies, which sampled throughout the Southern California Bight from 1984 to 1995 (Hayward and Venrick 1998). The CalCOFI cruises continue to sample plankton in the Southern California Bight; between 1995 and 2005 annual standing stock of chlorophyll *a* was constant and fluctuations within the year showing maximums during the spring (Peterson et al. 2006; McClatchie et al. 2008).

The CalCOFI cruises also sampled for zooplankton. Over 12 years (1984-1995), Hayward and Venrick (1998) present macrozooplankton biomass that varies greatly between years and months. A difference of an order of magnitude is captured between individual April and May values, suggesting variable conditions seasonally and annually, and the ability of the system to support high levels of biomass (Hayward and Venrick 1998). Since 1999 a decrease in annual average zooplankton has been observed throughout the CalCOFI sampling area and decreased biomass persisted at least through 2007 (Peterson et al. 2006; McClatchie et al. 2008).

4.3 GROWTH AND PRODUCTIVITY OF PLANKTON

Phytoplankton production is influenced by a number of factors including currents, upwelling, water temperature, nutrients, and light. The physical properties of the local currents bring new water into the bight (see chapter 3 for discussion of physical properties of the Southern Study Area). These currents can also lead to upwelling events, in which cold, nutrient-rich water is brought from the bottom waters to the surface. This new water is full of resources, mainly nutrients, which can be utilized by phytoplankton (Anderson et al. 2008). Primary production has been calculated as part of the CalCOFI cruises; in the Southern California Bight primary production has averaged around 0.35 g C/m²/day over the past 20 years (1986-2005; Peterson et al. 2006).

Similarly, zooplankton growth is a result of the quantity and quality of available food. As mentioned above, zooplankton growth and productivity are linked to those of phytoplankton but the relationship is much harder to discern due to the time it takes the second trophic level to assimilate the biomass from the first. Because of this, zooplankton growth and phytoplankton growth are hardly ever highly correlated in time. What has been shown is that peaks of zooplankton will appear after peaks in phytoplankton (Cloern 1996). This happens both on a monthly scale and to a lesser degree on shorter time scales.

4.4 SPATIAL AND TEMPORAL PATTERNS OF PLANKTON

4.4.1 Long-Term Fluctuations

In the eastern Pacific several large-scale processes can affect the spatial and temporal patterns of plankton. These changes in the plankton are usually a result of changes in the physical properties of the ocean currents. The Pacific Decadal Oscillation is a large-scale physical process ([see chapter 1](#)) that has been linked to periods of increased and decreased productivity at many trophic levels. This has been observed in the plankton communities in the Southern California Bight and current trends indicate a period of heightened productivity (Mullin et al. 2003). A mid-scale process that greatly affects plankton communities is the El Niño/southern oscillation ([see chapter 1](#)). This change in water circulation patterns can effectively increase the ranges of species with affinities for warmer water and alter the community compositions in areas like the Southern California Bight where, because of its latitude, there is always a mix of species with southern and northern affinities (Rebstock 2002). In addition to the change in species composition, lower productivity during El Niño years is common because of the suppression of upwelling water (Kahru and Mitchell 2000). Suppression of water high in nutrients leads to lower production throughout the food web. Also, on an annual basis, upwelling processes generate periods of high and low productivity. Upwelling events change the physical and chemical properties of the water; this change results in a response in the plankton community (Rebstock 2002). All of these fluctuations have observable impacts on the plankton communities; additionally, more and more research is showing further impacts on higher trophic levels.

The standing stock of zooplankton in the Southern California Bight declined by 70 percent between the 1950s and the 1990s. Roemmich and McGowan (1995a) analyzed CalCOFI samples from these two decades and found a large discrepancy in biomass. One hypothesized explanation for this change is a correlated increase in sea surface temperatures. The authors argue that the warming surface temperatures alter the upwelling regime and this change results in reduced nutrients in the surface waters. This reduction of nutrients affects the productivity of the entire food web, as illustrated by lower zooplankton (Roemmich and McGowan 1995a, b). A subsequent paper that analyzed the same samples as Roemmich and McGowan (1995a, b) confirmed the results but argued that the observations were due to a regime shift in the Southern California Bight. Mullin et al. (2003) claim there was a regime shift in the 1970s, when productivity in the region declined and remained low for several decades. This regime shift was believed to be associated with the El Niño/southern oscillation index and they further believe 1999 marked the switch back to a more productive system (Mullin et al. 2003).

4.4.2 Nearshore

The nearshore region of the Southern California Bight is affected by both oceanic currents and terrestrial inputs. Otero and Siegel (2004) found chlorophyll levels in the Santa Barbara Channel were correlated to terrestrial runoff inputs in the winter and upwelling favorable winds in the spring. The chlorophyll response during the winter months follows the episodic nature of the runoff events, whereas concentrations in the spring through the fall are less volatile potentially due to the association with upwelling and sea surface temperature (Otero and Siegel 2004).

Zooplankton densities are higher nearshore than offshore. Ohman and Hsieh (2008) found that juvenile and adult stages of the calanoid copepod *Calanus pacificus* are found in higher concentrations in nearshore regions during both spring and fall seasons. Additionally, they found higher mortality rates in the nearshore and hypothesize that this is due to higher numbers of zooplanktivorous fish (Ohman and Hsieh 2008), suggesting that the food web is more productive inshore than offshore in the Southern California Bight.

4.4.3 Transition Zone

Hayward and Venrick (1998) identified a transition zone between the nearshore and offshore zones of chlorophyll in the Southern California Bight where sampling locations did not consistently fall into a defined regime. The authors defined the boundary between these two regions as the inshore edge of the low-salinity front of the California Current (Hayward and Venrick 1998). The fluctuating nature of the barrier, which is driven by the movement of the California Current (Hayward and Venrick 1998), creates a transition zone between the nearshore and offshore regions. Venrick (1998) showed that the phytoplankton community composition at nearshore and offshore sites varied and there was a noticeable transition between the communities. This transition zone was not consistent between years but was always present (Venrick 1998).

4.4.4 Offshore

In general, phytoplankton production offshore is relatively low, most often due to a lack of nutrients. This trend of lower chlorophyll production can be seen in Otero and Siegel (2004), where a yearly series of monthly chlorophyll concentrations shows varying levels between the Channel Islands and the coastline and little production occurring offshore of the islands. Hayward and Venrick (1998) also describe this pattern and found the offshore zone to be oligotrophic, or generally unproductive, with low and relatively uniform chlorophyll concentrations throughout their offshore locations.

4.4.5 Neuston

The sea surface environment provides an important habitat for many commercially, recreationally, and ecologically important organisms. This group of surface-dwelling organisms is commonly referred to as “neuston.” Neuston can be broken up into three ecological groupings (Hempel and Weikert 1972): “euneuston” are full-time, permanent inhabitants of the surface layer and are often comprised of small invertebrates, such as ostracods and chaetognaths; “facultative neuston” refers to part-time inhabitants, which exhibit movement patterns, such as diel vertical migration; and “pseudoneuston” are organisms that comprise the uppermost part of their population’s vertical distribution in the water column. Most phytoplankton species are found in the surface layer, as light is an integral resource to their growth, whereas zooplankton species can be found throughout the water column as they move vertically to maximize prey availability and minimize predation risk. Fish eggs, fish larvae, and crustacean larvae comprise a significant portion of the neustonic community (Grant 1986). The eggs of some fish and marine invertebrates are either positively buoyant or neutrally buoyant and are released in the surface layer. These eggs will remain in the neuston while they develop. The larval stages of some fish species appear to actively seek the surface layer by adjusting their swim bladders and therefore their buoyancy (e.g., sardines; Santos et al. 2006), while other species are noted as having larval

stages that are completely neustonic (e.g., flying gurnards (Dactylopteridae); Cowen 2002). The larval stages of brachyuran crabs are noted to swarm in the surface layer to avoid predation and utilize surface currents for offshore transport (Young 1995).

4.5 PELAGIC INVERTEBRATES

Gelatinous zooplankton are an important part of the plankton food web. They can make up a large portion of the biomass and are sometimes considered their own branch of the food web as they do not have as many predators as do smaller crustacean zooplankton. Pelagic tunicates are one group of gelatinous zooplankton that are found in the Southern California Bight. Lavaniegos and Ohman (2003) found that pelagic tunicate communities, consisting primarily of salps and doliolids, were correlated with long-term changes in the physical characteristics of the California Current. Changes in these communities were variable year to year but remained fairly consistent throughout the warm regime (1977-1998) followed by a switch in dominant species following the regime shift in 1998-99 (Lavaniegos and Ohman 2003).

Larger pelagic invertebrates are another important part of the food web off Southern California. The California market squid, *Loligo opalescens*, is one of the largest fisheries in the state. These animals feed and breed in the Southern California Bight. Their eggs are deposited into sandy sediments and release paralarvae, a planktonic stage that spends several weeks in the water column. Zeidberg and Hammer (2002) investigated the spatial and temporal distribution of these larvae within the Southern California Bight. They found that young paralarvae were often trapped in eddies around the Channel Islands before they reach a size at which they are able to swim out into the offshore currents (Zeidberg and Hammer 2002). The populations in the Southern California Bight fluctuate with changing oceanic conditions, with El Niño conditions having a noticeable negative effect; production is inversely related to sea surface temperature and it rebounds quickly, within a year or two (Reiss et al. 2004).

The jumbo squid (*Dosidicus gigas*) can also be found off the coast of California. Increased numbers of jumbo squid were observed in the Southern California Bight during the 1997-98 El Niño and during sampling between 2002 and 2006 (Field et al. 2007). Field et al. (2007) reported that the seasonal variation of this species was variable over their sampling period, occurring in summer months during one year and winter months another. This study also described the jumbo squid as an important member of the food web, consuming pelagic, mesopelagic, and groundfish, as well as other cephalopods and pelagic crustaceans.

4.6 SUMMARY AND DATA GAPS

Plankton communities support the entire food web and are important indicators of overall system productivity. Correlations between plankton and climatic events are proving to be useful tools in understanding the connectivity between physical and biological ecosystem changes. The continuation of the CalCOFI sampling regime is an important part of the continued monitoring of these trophic levels in the Southern California Bight.

Cross-shelf comparisons of chlorophyll production and phytoplankton are common for this region. However, little work has been done to quantify the change in the zooplankton

community over similar spatial scales. While it is noted that the offshore regions are fairly oligotrophic and do not support the same abundances (Ohman and Hsieh 2008), there has not been a comprehensive look at community dynamics. These dynamics are well-studied off the coasts of Oregon and Northern California, but they have not been widely investigated in the Southern California Bight.

Vertical spatial variability also needs to be explored more. The CalCOFI cruises sample for zooplankton by sampling over the entire water column. While this data set is an excellent resource, it does not allow for depth-stratified analyses. This research would help to classify the community of neuston in the Southern California Bight, which would be the most impacted portion of the plankton community in the event of an oil or gas spill.

Information on larger pelagic invertebrates is not complete. Gelatinous species are important parts of the marine food web as they can be predators and competitors with larval fish. Larger species represent a separate branch of the food web, in which production consumed becomes unavailable to fish and other members of the traditional food web. Information regarding this community is needed to fully assess production within the system and potential impacts of offshore oil and gas development.

4.7 LIST OF LITERATURE CITED—PHYTOPLANKTON

- Anderson, C.R., D.A. Siegel, M.A. Brzezinski and N. Guillocheau. 2008. Controls on temporal patterns in phytoplankton community structure in the Santa Barbara Channel, California. *Journal of Geophysical Research* 113, C04038, doi:10.1029/2007JC004321, 2008.
- Brinton, E. 1967. Vertical migration and avoidance capability of euphausiids in the California current. *Limnology and Oceanography* 12(3):451-483.
- Brinton, E. 1976. Population biology of *Euphausia pacifica* of Southern California. *Fisheries Bulletin* 74: 733-762
- Brinton, E. and A. Townsend. 2003. Decadal variability in abundances of the dominant euphausiid species in southern sectors of the California Current. *Deep Sea Research II* 50:2449-2472.
- Cloern, J.E. 1996. Phytoplankton bloom dynamics in coastal ecosystems: A review with some general lessons from sustained investigations of San Francisco Bay. *Reviews of Geophysics* 34(2):127-168.
- Cowen, R.K. 2002. Oceanic influences on larval dispersal and retention and their consequences for population connectivity. In: Sale, P.F., ed. *Coral reef fishes, dynamics and diversity in a complex ecosystem*. San Diego, CA: Academic Press. Pp. 149–169.
- Field, J.C., K. Baltz, A.J. Phillips and W.A. Walker. 2007. Range expansion and trophic interactions of the jumbo squid, *Dosidicus gigas*, in the California Current. *CalCOFI Reports* 48:131-146.

- Grant, G.C. 1986. Zooneuston: Animals of the sea surface. In: Proceedings of the Workshop on the Sea-Surface Microlayer in Relation to Ocean Disposal, December 18-19, 1985, Airlie, Virginia. EPA report 556/1-87/005. Pp. 45-62.
- Hayward, T.L. and E.L. Venrick. 1998. Nearsurface pattern in the California current: Coupling between physical and biological structure. *Deep Sea Research II* 45:1617-1638.
- Hempel, G. and H. Weikert. 1972. The neuston of the subtropical and boreal Northeastern Atlantic Ocean. A Review. *Marine Biology* 13:70-88.
- Kahru, M. and B.G. Mitchell. 2000. Influence of the 1997-98 El Niño on the surface chlorophyll in the California current. *Geophysical Research Letters* 27(18):2937-2940.
- Landry, M.R., W.K. Peterson and V.L. Fagerness. 1994. Mesozooplankton grazing in the Southern California Bight. I. Population abundances and gut pigment contents. *Marine Ecology Progress Series* 115:55-71.
- Lavaniegos, B.E. and M.D. Ohman. 2003. Long-term changes in pelagic tunicates of the California current. *Deep-Sea Research II* 50:2473-2498.
- Lavaniegos, B.E. and M.D. Ohman. 2007. Coherence of long-term variations of zooplankton in two sectors of the California Current System. *Progress in Oceanography* 75:42-69.
- McClatchie, S., J. Gottschalck, M. L'heureux, Y. Xue, B. Mitchell, M. Kahru, R. Goericke, J. Koslow, W. Peterson, R. Emmett, D. Hyrenbach, W. Sydeman, F. Schwing, S. Bograd, C. Collins, R. Bradley, P. Warzybok, R. Charter, W. Watson, N. Lo, K. Hill, G. Gaxiola-Castro, R. Durazo and E. Bjorkstedt. 2008. The state of the California current, 2007-2008: La Nina conditions and their effects on the ecosystem. *CalCOFI Reports* 49:39-76.
- Mullin, M.M., D.M. Checkley and M.P. Thimgan. 2003. Temporal and spatial variation in the sizes of California current macrozooplankton: Analysis by optical plankton counter. *Progress in Oceanography* 57:299-316.
- Ohman, M.D. and C.-H. Hsieh. 2008. Spatial differences in mortality of *Calanus pacificus* within the California Current System. *Journal of Plankton Research* 30(4):359-366.
- Otero, M.P. and D.A. Siegel. 2004. Spatial and temporal characteristics of sediment plumes and phytoplankton blooms in the Santa Barbara Channel. *Deep Sea Research II* 51:1129-1149.
- Peterson, B., R.T. Emmett, R. Goericke, E. Venrick, A. Mantyla, S.J. Bograd, F.B. Schwing, R. Hewitt, N. Lo, W. Watson, J. Barlow, M. Lowry, S. Ralston, K.A. Forney, B.E. Lavaniegos, W.J. Sydeman, D. Hyrenbach, R.W. Bradley, P. Warzybok, F. Chavez, K. Hunter, S. Benson, M. Weise, J. Harvey, G. Gaxiola-Castro and R. Durazo. 2006. The state of the California current, 2005-2006: Warm in the north, cool in the south. *CalCOFI Report* 47:30-74.

- Rebstock, G.A. 2001. Long-term stability of species composition in calanoid copepods off Southern California. *Marine Ecology Progress Series* 215:213-224.
- Rebstock, G.A. 2002. Climatic regime shifts and decadal-scale variability in calanoid copepod populations off Southern California. *Global Change Biology* 8:71-89.
- Reiss, C.S., M.R. Maxwell, J.R. Hunter and A. Henry. 2004. Investigating environmental effects on population dynamics of *Loligo opalescens* in the Southern California Bight. *CalCOFI Reports* 45:87-97.
- Roemmich, D. and J.A. McGowan. 1995a. Climatic warming and the decline of zooplankton in the California current. *Science* 267:1324-1326.
- Roemmich, D. and J.A. McGowan. 1995b. Sampling zooplankton: correction. *Science* 268:352-353.
- Roesler, C.S. and D.B. Chelton. 1987. Zooplankton variability in the California Current, 1951-1982. *CalCOFI Reports* 28:59-96.
- Santos, A.M.P., P. Re, A. Dos Santos and Á. Peliz. 2006. Vertical distribution of the European sardine (*Sardina pilchardus*) larvae and its implications for their survival. *Journal of Plankton Research* 28:523-532.
- Siegel, V. 2000. Krill (*Euphausiacea*) life history and aspects of population dynamics. *Canadian Journal of Fisheries and Aquatic Science* 57(3):130-150.
- Venrick, E.L. 1998. Spring in the California Current: The distribution of phytoplankton species, April 1993 and April 1995. *Marine Ecology Progress Series* 167:73-88.
- Young, C.M. 1995. Behavior and locomotion during the dispersal phase of larval life. In: McEdward, L., ed. *Ecology of Marine Invertebrate Larvae*. CRC Press, Danvers, MA. Pp. 249-277.
- Zeidberg, L.D. and W.M. Hammer. 2002. Distribution of squid paralarvae, *Loligo opalescens* (*Cephalopoda: Myopsida*), in the Southern California Bight in the three years following the 1997-1998 El Niño. *Marine Biology* 141:111-122.

5. MACROPHYTES

Macrophytes encompass many different types of conspicuous aquatic plants. Macrophytes can be categorized as submersed, emerged, or floating or floating-leaved. Submersed plants grow completely below the surface, emerged plants are rooted in the sediments and extend above the surface of the water, and floating or floating-leaved plants are rooted or free-floating with leaves that float on the surface. These organisms are important primary producers in coastal systems; they also provide structured habitats for many different organisms.

5.1 FLORISTICS AND BIOGEOGRAPHY

The physical characteristics of the Southern California Bight, its location between several currents and its latitudinal position, result in a diverse and unique macrophyte community. The biogeography of most trophic groups has been investigated in this area, which commonly supports species of both northern and southern affinities. On a smaller scale, investigations into the genetic similarities and differences between populations within the Bight and just north, around Point Conception, are also numerous. It is at Point Conception that the Oregonian and Californian biogeographical provinces meet, although yearly variations in currents and upwelling keep this from being an impassible barrier (Blanchette et al. 2008). The biogeography of macrophytes in general is discussed extensively in Murray and Bray (1993), while Blanchette et al. (2008) focus on the rocky intertidal communities.

The Southern Study Area contains several busy shipping ports, including Los Angeles/Long Beach and San Diego. Increased shipping over the past couple of decades has increased incidents of introduced species. While much attention has been paid to invasive animals, this issue also applies to macrophytes. The nonnative kelp *Undaria pinnatifida* has been introduced throughout much of the world from its native range along the eastern coast of Asia. Several populations have taken hold in the Southern California Bight near Catalina Island and off Santa Barbara (Thornber et al. 2004). These populations have not become invasive, because warm temperatures favor the native kelp species. However, in Northern California this species has become invasive due to the lower water temperatures (Thornber et al. 2004). This alien species in the Southern California Bight has the potential to become invasive especially if the area reverts to a generally colder state, a phenomenon that results from large oceanic and climatic processes including El Niño and the Pacific Decadal Oscillation ([see chapter 3](#)). Another invasive, the aquarium plant *Caulerpa taxifolia*, was found in coastal waters in 2000 and 2001 (Jousson et al. 2000; Williams and Grosholz 2002). However, quick response and continued removal have resulted in the eradication of this invasive species from the original infestation sites (Woodfield and Merkel 2006).

5.2 PATTERNS OF STRUCTURE AND SEASONAL-INTERANNUAL VARIATION OF COMMUNITIES

5.2.1 Embayments: Salt Marshes, Lagoons, Modified Estuaries

Wetlands and estuaries are low-energy coastal habitats, which are important refuge and feeding areas for many animals, including larval fish and coastal bird species (Zedler 1996; Duffy 2006).

Due to continued development in Southern California these habitats have been in decline in area and functionality. The patches of marsh and seagrasses that remain are often fragmented, susceptible to invasion by exotic species, and of poor quality for animal residents. Restoration of these ecologically important habitats has been a focus in recent years as their ecosystem values have been elucidated.

Seagrasses are flowering marine plants found in soft-bottom shallow habitats. Eelgrass (*Zostera marina*) is a common seagrass found in most temperate and tropical oceans. Seagrass beds are important habitat for many species, offering refuge to young life stages from predation. They are also resources, as a source of oxygen to the waters, and they support a productive benthic and epifaunal community (reviewed in Duffy 2006). Worldwide, seagrass beds have been in decline, especially close to urban areas, where eutrophication of the coastal waters reduces light availability and therefore seagrass growth (Vermaat 1997). Changes in environmental conditions could also have a pronounced effect on the abundance of these species. Johnson et al. (2003) found that the warmer water temperatures during the 1997 El Niño event corresponded to an increase in the dominance of a ruderal grass (*Ruppia maritima*) over the non-El Niño-dominant eelgrass. The authors argue that the shift to subdominant species could lead to reduced ecosystem functions based on differences in biomass, production rates, and associated benthic communities (Johnson et al. 2003). Several species of the genus *Zostera* are found throughout the California Channel Islands, where the meadows are largely undisturbed by human activity (Coyer et al. 2008). These populations are not as genetically robust as the mainland populations; this may indicate isolation potentially due to oceanographic conditions (Coyer et al. 2008).

Cordgrass (*Spartina* spp.) is more commonly found on the Atlantic and Gulf Coasts of North America. On the Pacific Coast only one species, *S. foliosa*, is native to the upper fringes of the intertidal habitats of estuaries. However, widespread invasion of other *Spartina* species has had large impacts on the estuaries of the Pacific Coast (Daehler and Strong 1996). While invasions in the Southern Study Area have not been nearly as widespread as those documented on the northern Pacific Coast of the United States, the potential is still a concern, because marshes in Southern California, dominated by *S. foliosa*, have been shown to support larger and more diverse macrobenthos populations than East Coast marshes of *S. alterniflora* (Levin et al. 1998). Pickleweed (*Salicornia* spp.) is a salt marsh plant that overlaps habitat with *Spartina foliosa* at lower tidal elevations and dominates at higher elevations and supports a similar type of macrobenthic community (Whitcraft and Levin 2007).

Salt marsh bird beak (*Cordylanthus maritimus* ssp. *maritimus*) is endemic to Southern California salt marshes and is a federally listed endangered species. The decline of this species is believed to be due to the loss of habitat in the region to urbanization and the increase in exotic species (Parsons and Zedler 1997).

Macroalgae are another component of the coastal macrophyte community. These opportunistic genera (*Enteromorpha*, *Ulva*, and *Gracilaria*) are common in Southern California estuaries and can become a nuisance as they respond quickly to increased nutrient inputs (Kamer et al. 2001). Because of this large growth potential, the biomass of these genera varies greatly throughout the seasons; an increase of an order of magnitude was recorded between estuaries in Southern

California (from less than 300 to over 2,000 g wet weight per m³, (Kennison et al. 2005). An increase of this degree has detrimental impacts on the other biota vying for the same nutrient and light resources.

5.2.2 Rocky Intertidal

The rocky intertidal is a dynamic habitat affected by many environmental variables. The species that reside in this zone must be able to persist completely submerged and completely exposed over the tidal phase. Additionally, wave action varies with the tide, tidal cycle, season, and storm events. Many different types of primary producers inhabit this zone. In semi-protected areas the algal community in the Southern California Bight is dominated by fucacean rockweeds, primarily *Silvetia compressa* and *Hesperophycus californicus*. Seasonally these rockweeds increase in biomass over the summer seasons and lose biomass during increased storm activity in the winter (Sapper and Murray 2003). These species create a canopy under which many animal species take refuge during periods of low water. A study of community dynamics on rocky beaches of Santa Cruz Island found macrophyte density to be inversely correlated with sea surface temperature (Blanchette et al. 2006). Variation between sites around the island was high due to the influence of different currents on different sides of the island.

5.2.3 Subtidal Kelp Forests

Stands of giant kelp (*Macrocystis pyrifera*) cover much of the rocky substrate off the coast of Southern California. *M. pyrifera* grows densely, creating a vertically structured habitat in depths up to 30 meters. Giant kelp creates microhabitats at different canopy levels where other macrophytes diversify the forest. The community composition of a kelp forest is a function of many physical factors, including substratum, wave exposure, nutrient concentrations, and water clarity. *M. pyrifera* dominates the biomass of Southern California kelp forests and creates the upper canopy (Graham 2004). The subcanopy consists of stipulate, plants with a stem-like extension between the holdfast and blade, and nonstipulate, or low-lying, forms of kelp. The most common stipulate forms are *Eisenia arborea* and *Pterygophora californica*, and the common low-lying forms are *Dictyoneuropsis reticulate* and *Laminaria farlowii* (Graham 2004). Differences among the kelp forest within the Southern California Bight are described in detail in Murray and Bray (1993).

The spatial heterogeneity between kelp forests within the Southern California Bight may be a result of the circulation patterns, which bring different water masses into the area ([see chapter 1](#)). The water masses are differentiated mainly by temperature and nutrient concentrations. Because upwelling is usually the source of colder water, it is associated with higher nutrient concentrations in the Southern California Bight. During warming events, including El Niño, growth is suppressed and in some cases devastated. The 1997-1998 El Niño caused large-scale mortality to the Southern California sector of the range of *Macrocystis*, which stretches from Baja California up to Monterey Bay, California (Edwards 2004). While this El Niño event was one of the worst on record, the populations off Southern California recovered quickly, on the order of a few months, due to the strong La Niña conditions of the following year. However, the factors affecting the recovery of kelp forests were much more nuanced than those applicable to their destruction (Edwards and Estes 2006). Edwards and Estes (2006) analyzed the destruction and recovery of the giant kelp population over its entire range and found that while the loss of

Macrocystis was related to warmer waters and lower nutrient over the regional scale, its recovery was related to smaller scale differences. Edwards and Estes (2006) hypothesized that these small-scale processes included proximity to upwelling water, competition, and herbivory in addition to the large-scale reversal of El Niño conditions (Edwards and Estes 2006).

Macrocystis easily colonizes hard substrates of high- and low-relief rock but can also grow in sandier substrates if protected from high wave exposure. Attachment to hard substrates is more common because the plants are positively buoyant, so that their fronds rise into the water column, and in order to counteract floating, the holdfast must be well anchored to the substrate. Sedimentation also plays a role in shaping the community of a kelp forest. Some species are more resistant to burial than others. Additionally, sediments can be abrasive in high-energy areas and can scour macrophytes.

Water movement through kelp forests is integral to the community as new water brings new resources into the system. Water movement is usually greatest at the edges of the forest and declines farther into the forest (Gaylord et al. 2007; Rosman et al. 2007}. The motion of water also differs vertically. Wind stress will affect the very top of the water column, the currents define the midwater region, the surge zone is found just above the bottom, and the turbulent-laminar and still-water zones make up the boundary layer just above the substrate. Macrophytes have evolved different ways to live in or across these zones in the water column. These dynamics are altered during storm events. Storms, which increase wave energy, are very destructive to canopy species and have the potential for greater impact in shallower areas (Ebeling et al. 1985).

In kelp forests light is a necessary yet variable resource. Depending on canopy cover, iridescence from the surface to 1 meter depth can change drastically. The thickness of the canopy can shape the understory community and if some of the canopy is removed, the understory may change to take advantage of the extra resources (Clark et al. 2004). Similarly, turbidity will have a pronounced effect, especially on the understory, where light resources are small to begin with.

Kelp populations propagate through the dispersal of spores. *Macrocystis* produces spores throughout the year and can produce over 10 trillion zoospores per year (Graham 2002). However, the release of spores is rarely constant and is often impacted by environmental variables and the trade-offs with somatic growth. Once released, the spores remain in the water column for up to several days as they are moved around both horizontally, via currents, and vertically, via winds, waves, and water stratification (Gaylord et al. 2002; Gaylord et al. 2004). As mentioned previously, water movement within a kelp forest is often altered by the vertical structure of the habitat and thus physical forcing within this environment will be different than it is in the surrounding open water (Gaylord et al. 2007; Rosman et al. 2007). This will greatly alter the distribution potential of spores release at the interior versus the edge of kelp forests.

5.2.4 Floating Macroalgae

Drifting kelp rafts are common in the Southern California Bight. These rafts form when giant kelp, *Macrocystis pyrifera*, becomes detached from the substrate; they persist by floating on the

surface. If they are not entangled or immediately washed ashore, these rafts can persist for several months (Hobday 2000a). Detachment of *M. pyrifera* is most common in the winter, when storms in the area increase water movement (Hobday 2000b). Once detached these rafts can disperse in any direction and may act as unique microhabitats in the Southern California Bight (Hobday 2000c). The circulation within the Bight may act to retain these rafts (Kingsford 1995).

These rafts represent mobile microcommunities which can aid the dispersal of organisms between isolated kelp forests (Hobday 2000c). The fauna found on kelp rafts initially mirror those of an attached kelp epifaunal community. While floating the community can gain or lose species as resources fluctuate and the rafts travel over various habitat types. Species with pelagic stages may encounter these habitats and utilize the extra protection and resources they provide. This may be an important dispersal mechanism for invertebrates and fish species, including rockfish, *Sebastes* spp. (Kingsford 1995). As the raft ages it eventually loses its epifauna community and becomes more inhospitable. Dispersal of invertebrates is thought to be more successful over shorter distances and time although these rafts can persist upwards of four months (Hobday 2000b;Hobday 2000c).

5.3 MACROPHYTE PRODUCTIVITY

Kelp forests are some of the most productive marine ecosystems. The net primary productivity in Southern California kelp forests averaged between 0.42 and 2.38 kg dry mass/m²/yr¹ with an average foliar standing stock of 0.444 kg dry mass/m² (Reed et al. 2008). These relatively high numbers vary due to reductions in biomass caused by seasonality and destruction events but are similar to productivity rates found in central California forests (Reed et al. 2008). Productivity in Southern California is usually limited by nitrogen and by density-dependent light limitation; lowest production rates were found during the winter, when increased wave action removed much of the foliar standing stock and production slowed at times of high biomass (Reed et al. 2008). Recent studies of the production rate of other macrophytes are not available.

5.4 COMMERCIALY AND RECREATIONALLY IMPORTANT SPECIES

Macrocystis pyrifera is harvested for food, cosmetic, and fertilizer products, but little is known about how this harvesting impacts the species or ecosystem (Graham et al. 2008). In 2001 California Department of Fish and Game (CA DFG) adopted several new amendments to the commercial kelp harvesting regulations which included increased bed closures and prior approval for the use of mechanical harvesters (CA DFG 2004). At that time the industry was valued at over \$30 million and landed close to 50,000 tons of kelp from coastal waters; this is down from a peak in 1990 where 150,000 tons were landed (CA DFG 2004). The decline in harvest has been attributed to competition of other algae products from Japan (CA DFG 2004).

5.5 SUMMARY AND DATA GAPS

Macrophytes are important components of nearly every ecosystem. In addition to generating resources essential for life, these plants provide structural complexity, which creates microhabitats and niches, which support a wide diversity of higher trophic levels.

Because the development of the Southern California coast has resulted in the modification of natural habitats, the most recent literature on seagrasses and other coastal macrophytes has focused on restoration. More recently, development has included remediation targeted at restoring wetlands. Thus, the focus of the literature has been on identifying impacts on remaining wetlands and techniques for successful restoration. As a result, there is little updated information that describes these habitats in as much detail as presented in Murray and Bray (1993).

5.6 LIST OF LITERATURE CITED—MACROPHYTES

- Blanchette, C.A., B.R. Broitman and S.D. Gaines. 2006. Intertidal community structure and oceanographic patterns around Santa Cruz Island, CA, USA. *Marine Biology* 149(3):689-701.
- Blanchette, C.A., C.M. Miner, P.T. Raimondi, D. Lohse, K.E.K. Heady and B.R. Broitman. 2008. Biogeographical patterns of rocky intertidal communities along the Pacific Coast of North America. *Journal of Biogeography* 35(9):1593-1607.
- California Department of Fish and Game (CA DFG). 2004. Annual status of the fisheries report through 2003. Report to the Fish and Game Commission as directed by the Marine Life Management Act of 1998. California Department of Fish and Game, Marine Region, December 2004.
- Clark, R.P., M.S. Edwards and M.S. Foster. 2004. Effects of shade from multiple kelp canopies on an understory algal assemblage. *Marine Ecology Progress Series* 267:107-119.
- Coyer, J.A., K.A. Miller, J.M. Engle, J. Veldsink, A. Cabello-Pasini, W.T. Stam and J.L. Olsen. 2008. Eelgrass meadows in the California Channel Islands and adjacent coast reveal a mosaic of two species, evidence for introgression and variable clonality. *Annals of Botany* 101(1):1-15.
- Daehler, C.C. and D.R. Strong. 1996. Status, prediction and prevention of introduced cordgrass *Spartina* spp. invasions in Pacific estuaries, USA. *Biological Conservation* 78(1-2):51-58.
- Duffy, J.E. 2006. Biodiversity and the functioning of seagrass ecosystems. *Marine Ecology Progress Series* 311:233-250.
- Ebeling, A.W., D.R. Laur and R.J. Rowley. 1985. Severe storm disturbances and reversal of community structure in a Southern California kelp forest. *Marine Biology* 84:287-294.
- Edwards, M.S. 2004. Estimating scale-dependency in disturbance impacts: El Niños and giant kelp forests in the northeast Pacific. *Oecologia* 138(3):436-447.
- Edwards, M.S. and J.A. Estes. 2006. Catastrophe, recovery and range limitation in NE Pacific kelp forests: A large-scale perspective. *Marine Ecology Progress Series* 320:79-87.

- Gaylord, B., D.C. Reed, P.T. Raimondi, L. Washburn, and S.R. McLean. 2002. A physically based model of macroalgal spore dispersal in the wave and current-dominated nearshore. *Ecology* 83(5):1239-1251.
- Gaylord, B., D.C. Reed, L. Washburn and P.T. Raimondi. 2004. Physical–biological coupling in spore dispersal of kelp forest macroalgae. *Journal of Marine Systems* 49(1-4):19-39.
- Gaylord, B., J.H. Rosman, D.C. Reed, J.R. Koseff, J. Fram, S. Macintyre, K. Arkema, C. McDonald, M.A. Brzezinski and J.L. Largier. 2007. Spatial patterns of flow and their modification within and around a giant kelp forest. *Limnology and Oceanography* 52(5):1838-1852.
- Graham, M. 2002. Prolonged reproductive consequences of short-term biomass loss in seaweeds. *Marine Biology* 140(5):901-911.
- Graham, M.H. 2004. Effects of local deforestation on the diversity and structure of Southern California giant kelp forest food webs. *Ecosystems* 7(4):341-357.
- Graham, M., B. Halpern, and M. Carr. 2008. Diversity and dynamics of California subtidal kelp forests. In: McClanahan, T. and G. Branch. *Food webs and the dynamics of marine reefs*. Oxford University Press, Oxford, England. Pp. 103-134.
- Hobday, A.J. 2000a. Age of drifting *Macrocystis pyrifera* (L.) C. Agardh rafts in the Southern California Bight. *Journal of Experimental Marine Biology and Ecology* 253(1):97-114.
- Hobday, A.J. 2000b. Abundance and dispersal of drifting kelp *Macrocystis pyrifera* rafts in the Southern California Bight. *Marine Ecology Progress Series* 195:101-116.
- Hobday, A.J. 2000c. Persistence and transport of fauna on drifting kelp (*Macrocystis pyrifera* (L.) C. Agardh) rafts in the Southern California Bight. *Journal of Experimental Marine Biology and Ecology* 253(1):75-96.
- Johnson, M.R., S.L. Williams, C.H. Lieberman and A. Solbak. 2003. Changes in the abundance of the seagrasses *Zostera marina* L. (eelgrass) and *Ruppia maritima* L. (widgeongrass) in San Diego, California, following an El Niño event. *Estuaries and Coasts* 26(1):106-115.
- Jousson, O., J. Pawlowski, L. Zaninetti, F.W. Zechman, F. Dini, G. Di Guiseppe, R. Woodfield, A. Millar and A. Meinesz. 2000. Invasive alga reaches California. *Nature* 408(6809):157-158.
- Kamer, K., K.A. Boyle and P. Fong. 2001. Macroalgal bloom dynamics in a highly eutrophic Southern California estuary. *Estuaries and Coasts* 24(4):623-635.
- Kennison, R., K. Kamer and P. Fong. 2005. Nutrient dynamics and macroalgal blooms: A comparison of five Southern California estuaries. Annual report. Southern California Coastal Water Research Project (2003).

- Kingsford, M.J. 1995. Drift algae: A contribution to near-shore habitat complexity in the pelagic environment and an attractant for fish. *Marine Ecology Progress Series* 116(1):297-301.
- Levin, L.A., T.S. Talley and J. Hewitt. 1998. Macrobenthos of *Spartina foliosa* (Pacific cordgrass) salt marshes in Southern California: Community structure and comparison to a Pacific mudflat and a *Spartina alterniflora* (Atlantic smooth cordgrass) marsh. *Estuaries* 21(1):129-144.
- Murray, B.S.N. and R.B. Bray. 1993. 7. Benthic Macrophytes. University of California Press, Berkeley. Pp. 304-368.
- Parsons, L.S. and J.B. Zedler. 1997. Factors affecting reestablishment of an endangered annual plant at a California salt marsh. *Ecological Applications* 7(1):253-267.
- Reed, D.C., A. Rassweiler and K.K. Arkema. 2008. Biomass rather than growth rate determines variation in net primary production by giant kelp. *Ecology* 89(9):2493-2505.
- Rosman, J.H., J.R. Koseff, S.G. Monismith and J. Grover. 2007. A field investigation into the effects of a kelp forest (*Macrocystis pyrifera*) on coastal hydrodynamics and transport. *Journal of Geophysical Research* 112: C02016, doi:10.1029/2005JC003430.
- Sapper, S.A. and S.N. Murray. 2003. Variation in structure of the subcanopy assemblage associated with Southern California populations of the intertidal rockweed *Silvetia compressa* (*Fucales*). *Pacific Science* 57(4):433-462.
- Thorner, C.S., B.P. Kinlan, M.H. Graham and J.J. Stachowicz. 2004. Population ecology of the invasive kelp *Undaria pinnatifida* in California: Environmental and biological controls on demography. *Marine Ecology Progress Series* 268:69-80.
- Vermaat, J.E. 1997. The capacity of seagrasses to survive increased turbidity and siltation: The significance of growth form and light use. *Ambio* 26(8):499-504.
- Whitcraft, C. and L. Levin. 2007. Regulation of benthic algal and animal communities by salt marsh plants: Impact of shading. *Ecology* 88(4):904-917.
- Williams, S and E Grosholz. 2002. Preliminary reports from the *Caulerpa taxifolia* invasion in Southern California. *Marine Ecology Progress Series* 233:307-310.
- Woodfield, R. and K. Merkel. 2006. Eradication and surveillance of *Caulerpa taxifolia* within Agua Hedionda Lagoon, Carlsbad, California. Fifth-year Status Report.
- Zedler, J.B. 1996. Tidal wetland restoration: A scientific perspective and Southern California focus. La Jolla, California: California Sea Grant College System, University of California.

6. BENTHOS

6.1 BENTHIC HABITATS AND ASSEMBLAGES

Benthic habitats of the Southern Study Area provide numerous ecological services to the marine environment. Organisms, particularly invertebrates, living in or on bottom substrates are referred to as “benthos.” Benthic habitats may consist of both primary and secondary producers and serve as an important forage base to higher trophic levels. Benthic organisms are also integral to ecological processes including the cycling of carbon, oxygen, and nutrients. Marine habitats are characterized by composition of the substrate as well as by ecological community features and species assemblage.

Several physical and environmental factors can influence the distribution and composition of organisms in a benthic habitat. These factors include sediment type, grain size, bottom morphology, hydrodynamic conditions, depth, season, temperature, and salinity (Snelgrove and Butman 1994).

Physical substrate characteristics of the benthic habitats in the Southern Study Area include unconsolidated sediment types (sand, gravel, and clay) and consolidated lithified sediment types (sedimentary bedrock and rocky outcroppings) (Thompson et al. 1993a). Finer unconsolidated sands and clays are considered soft sediment habitats, while coarser gravel, rocks, and bedrock outcroppings are considered hard sediment habitats. Habitats may consist of mixed soft and hard sediments. Rocks and rocky outcroppings can be surrounded by patches of sand or clay, or covered by a thin veneer of fine sediments.

Bottom morphology is a function of shape and elevation range. Areas of high vertical relief tend to have irregular surface structure and high elevation ranges, whereas low vertical relief areas typically consist of uniform slopes and smaller ranges of elevation. Hard-bottom areas and areas of high relief are generally structurally complex. Increased structural complexity supplies organisms with several ecological provisions (e.g. predator refuge), leading to increased species diversity. Such habitats are potentially more vulnerable and sensitive to the impacts of disturbance (Jennings et al. 2001).

Seabed substrate composition and substrate mobility can indicate hydrodynamic energy level of the habitat. Areas consisting of finer sands and clays typically indicate low energy and depositional conditions. Areas consisting of coarser sands, gravels, and rocks are representative of higher wave and current energy and nondepositional conditions. Hydrodynamic activity determines physical habitat stability, which directly influences organism assemblage. Depth is an important factor in benthic composition and species distribution. Light attenuation, impacts from natural disturbance, and hydrodynamic activity are all related to depth of the habitat (Thompson et al. 1993a).

Benthic invertebrates inhabit the sea floor for a majority of their lifespan, although many species may have pelagic gametes or larval stages. Benthic invertebrates can be broken into following size categories: Microbenthos (2-50 μm) includes organisms such as protozoans; meiobenthos (50-300 μm) includes organisms such as nematodes, harpacticoid copepods, and ostracods;

macrobenthos (300-1,000 μm) includes organisms such as polychaetes and small bivalves; and megabenthos (greater than 1,000 μm) includes species such as large arthropods, bivalves, and gastropods. Benthos can be epifaunal (living on the seabed surface) or infaunal (within the seabed sediments). Benthic invertebrates may be attached to substrates (sessile), or capable of moving (motile).

Life history, feeding mechanism, and reproductive strategy of benthos in the Southern Study Area are diverse. Some species exhibit slow growth over longer life spans, while others may be opportunistic, fast growing, short lived, and capable of reproducing several times a year. Benthic invertebrates can be broadcast spawners, releasing eggs and sperm into the water column. Certain species may fertilize internally and brood their eggs or lay eggs on the benthic substrates. Larval and early life stages can be both benthic and pelagic. Feeding types include filtering, predation, herbivorous grazing, and deposit (Thompson et al. 1993a).

Some benthic invertebrate organisms (i.e. certain species of infaunal marine worms) can serve as indicators of stressed environmental conditions including habitat degradation, poor water quality, and physical disturbances. Indicator species are typically fast-growing and possess high reproductive rates.

There are several biological factors that influence benthic distribution including predation, differential recruitment, and population density. It is difficult to isolate which variables have the greatest influence on species distribution. Often benthic community structure and distribution are controlled by a combination of factors. For these reasons benthic species distribution may be patchy over both temporal and spatial scales (Snelgrove and Butman 1994).

This chapter characterizes the benthic habitats existing in shelf and nearshore areas and those in the deeper waters of the Southern Study Area. Habitats found in estuaries and embayments are also discussed. The shallow habitat types facing the open sea can be broken into rocky and sandy (intertidal and subtidal) categories. The habitats existing in deeper areas are organized by assemblage in rocky substrates, soft sediments, and chemosynthetic communities. Benthic recovery rates, commercially and recreationally important species, threatened and endangered species, and existing data gaps regarding benthic characterization in the Southern Study area are summarized.

6.1.1 Shallow Intertidal and Subtidal Habitats and Assemblages

6.1.1.1 Rocky Intertidal

Approximately 10-15 percent of the mainland of Southern California coast is rock (Stephens et al. 2006). In addition, the California Channel Islands, including Santa Cruz and Santa Catalina Island, consist largely of rocky shorelines. The rocky shorelines that exist along the coast of the Southern Study Area are composed of high sedimentary cliffs leading into rocky intertidal zones having broad, gently sloping wave-cut benches. Much of the rocky intertidal substrate is composed of many horizontal layers of poorly consolidated sandstone. The intertidal zones have numerous crevices, surge channels, and pools that are primarily low-medium relief features (Engle et al. 2001). There may be sand and gravel patches dispersed amongst and within the

stretches of rocky shoreline, or rocky surfaces can be continuous. These intertidal areas can be flat or gradually sloping and topped with scattered rocks and boulders, and may have bedrock outcroppings. Typically as the shoreline slopes toward the ocean, intertidal rocky reef is formed. Various widths of the intertidal reef have been observed. At Point Loma, San Diego County, intertidal reef widths ranged from 5 to 100 m offshore (Engle et al. 2001). Intertidal reef areas are usually fully or partially exposed to ocean swells.

Rocky intertidal reefs support diverse communities of both plant and animal species. The intertidal rocky shore substrate forms a solid surface on which macroalgae and sessile invertebrates attach and hold firm against the forces of waves, wind, and currents (Blanchette et al. 2009). In California, rocky intertidal zones are covered by large areas of primary producers (~70%) while filter feeders, consisting mainly of barnacles and mussels, cover a smaller area (~25%) (Blanchette et al. 2009). Numerous, usually smaller invertebrates, including grazers, filter feeders, and predators, live within the cover and protection provided by the larger sessile plants and animals.

Communities on the rocky shore are typically long-lived (decades) and have a high diversity of species. Typically microhabitats and horizontal biological zonation occur. Intertidal “zones” include the high, middle, and low (Thompson et al. 1993a). The exact tidal level at which these zones begin and end varies by shoreline. Often competition for space is observed in these communities. Organisms in rocky intertidal habitats have adapted to live in extreme environmental conditions that can vary daily (exposure to moisture, air, heat, and sunlight).

Biological distributions in rocky intertidal zones are influenced by several biological and physical factors. There is a wide range of wave exposure in these areas. Seasonal variation in water velocities may influence or limit macroalgal growth and composition (Engle et al. 1997). Schoch et al. (2006) state that wave runup is the most significant physical factor affecting community structure of rocky intertidal habitats. Wave runup is the distance that water from breaking waves travels across the intertidal zone beyond the regions of normal still water tidal levels. Runup brings water into areas that would otherwise be dry, providing food for animals and reducing the threat of desiccation. Tidal range, substrate composition, slope, air and water temperature, upwelling, salinity, desiccation tolerance, and sand deposition are also significant mechanisms in influencing biota assemblage (Schoch et al. 2006). A study performed on Santa Cruz Island showed strong positive correlation between intertidal filter-feeding invertebrate recruitment, abundance, and growth with sea surface temperature.

Fluctuations in epibenthic coverage are common and dependent on season and climatic regime shifts such as El Niño. Strong storm events and heavy surf can tear out patches of algae and can dislodge organisms and rocky substrate layers. Heavy rain events can result in increased freshwater runoff, erosion, landslides, and sediment deposition, all potentially having negative impacts on the rocky shoreline (Engle et al. 2001).

Many of the species in the rocky intertidal are broadcast spawners having pelagic eggs and larvae. Recruitment success is highly dependent on larval transport and hydrodynamic conditions. Pineda (1994) found that for Southern California barnacle species, temporal

variability in larval settlement rate may be related to larval pool and physical transport processes, while spatial variability may be associated with behavioral response and substrate availability. Broitman et al. (2008) examined the spatial variation of mussel and barnacle recruitment rates and their relationship to sea surface temperature for the entire West Coast. The seasonal peak in recruitment for both organisms in Southern California occurred during summer months, suggesting a positive correlation between recruitment and sea surface temperature (Broitman et al. 2008).

Top-down control by consumers on prey species has been demonstrated in several studies in rocky intertidal communities as reviewed by Menge (2000). Menge (2000) suggests that bottom-up trophic processes, ultimately controlled by oceanographic factors (currents, upwelling, nutrient availability, and rates of particle flux), also can be determinants of community structure. The joint effects of trophic top-down and bottom-up processes may play a significant role in rocky intertidal assemblage (Menge 2000).

The northern border of the Southern Study Area is located along the transition zone between the Oregonian (cooler water) and Californian (warmer water) biogeographic regions. The majority of the Southern Study Area exhibits typical Southern California warm water rocky intertidal species assemblage. In the northern areas around Point Conception and San Luis Obispo, a unique mix of warm-temperate and cold-temperate rocky intertidal species can occur. A few distinct differences exist between the organisms north and south of Point Conception (Engle et al. 1997). Rocky intertidal algal communities north of Point Conception are characterized by coldwater species such as laminarialean brown algae and large, fleshy red algae, whereas communities south of Point Conception are dominated by warm water fucal brown algal species and shorter, densely branched red algae (Engle et al. 1997). For example, warm-water sea palms (*Eisenia arborea*) and rockweed (*Hesperophycus harveyanus*) are less common or absent north of Point Conception, while cold-water sea palms (*Postelsia palmaeformis*) increase in abundance in San Luis Obispo County (Engle et al. 1997). Blanchette and Gaines (2007) found that intertidal communities north of Point Conception were dominated mainly by macrophytes, while mussels and barnacles were relatively scarce. Conversely, intertidal communities south of Point Conception were dominated by mussels and barnacles, with a low abundance of macrophytes (Blanchette and Gaines 2007).

For most of the Southern Study Area, the rocky substrates found in the high to middle intertidal zones are often covered by slippery algal films and hard crusts (Engle et al. 2001). Sessile barnacles such as white acorn (*Chthamalus* spp.), acorn (*Balanus glandula*), and pink thatched (*Tetraclita rubescens*) barnacles can be found in the high to middle intertidal zones attached to hard surfaces. Motile algae grazers including periwinkles (*Littorina* spp.), turban snails (*Tegula* spp.), limpets (*Lottia gigantea* and *Collisella* spp.), and chitons (*Nuttallina* spp.) are common inhabitants (Engle et al. 2001; Steinbeck et al. 2005). In the middle intertidal zone, other sessile epifaunal organisms such as rockweed (*Pelvetia fastigiata*, *Silvetia compressa*, and *Hesperophycus* spp.), California mussels (*Mytilus californianus*), and goose barnacles (*Pollicipes polymerus*) can be found.

Red algal species are found in the middle intertidal zone. The red algal assemblage creates a thick turf habitat that supports several invertebrate species including algal grazers. These algal bands trap moisture and sediment, providing refuge for intertidal organisms including snails, limpets, crustaceans, worms, and beach fly larvae (Engle et al. 1997). Typically in low depressions of the red algal turf zone and in tidepools, aggregating anemones (*Anthopleura elegantissima*) and sargassum weed (*Sargassum muticum*) can be found. Coralline algae such as *Corallina vancouveriensis* and *C. pinnatifolia* may dominate the algal assemblage, but several other epiphytic species may anchor onto them. In the northern regions of the Southern Study Area, several species of *Irridaea* can be found in the middle to lower intertidal zone (Steinbeck et al. 2005). Bullard (2005) found that macrophyte cover and composition in the high to middle intertidal zone can vary from site to site along the Southern California coast. These differences in abundance and species type can affect community productivity and hypothetically impact macrophyte contributions to the nearshore food web (Bullard 2005).

The low intertidal zone along the outer reef is typically dominated by extensive meadows of surfgrass (*Phyllospadix* spp.) (Thompson et al. 1993a). Brown algae (*Egregia* spp. and *Eisenia* spp.) also occur in lower intertidal areas in Southern California. The cement tube worm (*Phragmatopoma californica*), the sea slug (*Aplysia californica*), the purple sea urchin (*Strongylocentrotus purpuratus*), predaceous sea stars, and various octopus species can be found in this zone. Boa kelp (*Egregia menziesii*) has been found in the low intertidal, but is more common in subtidal regions. Engle et al. (2001) observed in San Diego County the occasional occurrence of a few typically subtidal species in the lower intertidal zone including green abalone (*Haliotis fulgens*), blue knobby stars (*Pisaster giganteus*), and bat stars (*Asterina miniata*).

The rocky intertidal communities of San Luis Obispo County are known for their relatively pristine condition. The 93-mile-long coast is mostly privately owned and undeveloped. Approximately 58 percent of the coastline is composed of rocky intertidal shore type. A monitoring study in San Luis Obispo County (1995-1997) revealed relatively low numbers of black abalone (*Haliotis cracherodii*) and a decrease in California mussels (*Mytilus californianus*) as compared to previous decades (Engle et al. 1997). Engle et al. (1997) observed a similar declines of these species at sampling sites in Santa Barbara County (1992-1997). Observations at sites in Santa Barbara and the Channel Islands indicate that space once inhabited by abalone was being occupied by encrusting species such as sponges, tunicates, barnacles, and tube worms and predaceous sea stars (Engle et al. 1997).

A survey in the early 1970s showed that bedrock intertidal reefs comprised less than 15 percent of the coastline of San Diego County, with the remainder consisting of sand, gravel, or cobble beaches (Smith et al. 1976). Most rocky intertidal shores in the county occur on the Point Loma and La Jolla peninsulas, with relatively few isolated reefs farther north (Engle et al. 2001). Similarly, the shorelines of Orange County are dominated by sandy beach with small pockets of rocky substrate. Historically, ochre sea stars (*Pisaster ochraceus*) and black abalone (*Haliotis cracherodii*) were present at these rocky intertidal areas but were both greatly reduced by disease (Blanchette et al. 2005; Miner et al. 2006). For ochre sea stars, the population was able to rebound from rare in the early 1990s (Engle et al. 2001) to recovering in the 2000s (Blanchette et

al. 2005). Blanchette et al. (2005) suggest that the increases in this species were a result of increased spawning and larval recruitment following the 1997-1998 El Niño event. For black abalone, much of the loss to the population has not been recovered at sites where the largest declines were documented (see section 6.3; Miner et al. 2006).

Long-term warming of the sea surface temperatures in the Southern Study Area has been associated with northward shifts in the ranges of southern species (Barry et al. 1995) and may be related to declines in rocky intertidal species such as black abalone, ochre sea stars, mussels, and boa kelp. In addition, human-related activities including discharging pollution from point sources (outfalls, vessel spills) and nonpoint sources (storm runoff) may have negative impacts on rocky intertidal habitats. Roy et al. (2003) has demonstrated that human harvesting in the last century has led to declines in body sizes of rocky intertidal gastropod species. For a detailed description of human visitation and harvesting impacts to Southern California rocky intertidal zones see Murray et al. (1999). The decline in the ochre sea star population can be attributed to a “wasting” disease caused by a warm-water bacterium of the genus *Vibrio* (Engle et al. 2001). The black abalone decline may be associated with a “withering” syndrome that has caused widespread populations die-offs in the Southern Study Area (Engle et al. 2001). The overall additive effects of withering syndrome, ocean warming, and overfishing have negatively impacted abalone populations in Southern California (Vilchis et al. 2005). Smith et al. (2006) reported that mussel cover and biomass along the Southern California coast have declined markedly over the last several decades (40.2 percent loss in cover, 51.3 percent loss in biomass). Causes for the California mussel decline are not known but may include human harvesting, increased sea surface temperatures, and pollution.

6.1.1.2 Sandy Beaches

Exposed sandy beaches are the predominant shore type along the mainland coast of the Southern Study Area. Sandy beach composes 74 percent of the coastline of Santa Barbara County, 93 percent of Ventura County, and 66 percent of Los Angeles County (Dugan et al. 2000b). Mainland beaches are heavily utilized by humans and are important tourist attractions in Southern California. Fewer sandy beaches are found on the Channel Islands (52 percent of San Miguel, 33 percent of Santa Rosa, and 14 percent of Santa Cruz) and support lower human usage (Dugan et al. 2000b). Several Channel Island beaches are important rookery sites for pinnipeds and nesting birds.

Intertidal sand beach habitats are much less stable environments than rocky shores, due to the continual shifting of sand by wind, wave, and current actions. Sandy beaches are typically high-energy, dynamic, and erosive environments. Seafloor structural complexity of these habitats is low. Vertical profiles of sandy beaches can change with climatic regimes and seasonal shifts. Typically summer beach profiles are steeper than winter ones (Thompson et al. 1993a). Exposed beach substrates are well sorted unconsolidated sand grains, devoid of finer grain sizes (clays, silts).

Most sand-dwelling organisms are very motile. Unlike the rocky intertidal zone, species will change position based on water level and tidal cycle. Regardless, a varying degree of zonation of benthic organisms does occur in sandy habitats. Certain species are typically found in higher and

lower zones. Burrowing and locomotory ability play an important role in the zonation and distribution of invertebrates (Dugan et al. 2000a). Sandy beach habitats have fewer resident invertebrates than do rocky shores. Generally, the only flora found in this habitat are diatoms and other microscopic species, and bacteria associated with organic detritus in the sand. The sand beach flora constitute a major food base for the numerous meiofauna (minute animals) that inhabit the interstitial spaces between sand grains (USDOI, MMS 2007).

Macrophyte wrack cover is found in the high intertidal and swash zone. Beach wrack consists of pieces of macrophyte and other flotsam washed ashore by the surf. Macrophyte wrack is an important habitat component of sandy beaches. Dugan et al. (2000b) found that macrofaunal invertebrate species richness and abundance were positively correlated with wrack cover. Beach grooming practices that remove wrack from the high intertidal zone may have impacts on macrofaunal communities (Dugan et al. 2000b). Additionally, invertebrates associated with macrophyte wrack are important forage items for shorebirds.

Typical macrofaunal invertebrates found in the high intertidal zone include beach hoppers (an amphipod, *Orchestoidea* spp.), the isopod *Excirrolana chiltoni*, and some infaunal polychaetes (Stephens et al. 2006). The middle intertidal zone is dominated by sand crabs (*Emerita analoga* and *Lepidopa californica*), the infaunal polychaete *Nephtys californica*, the snail *Olivella biplicata*, and the infaunal clam *Donax gouldi* (Stephens et al. 2006). Species found in the lower intertidal zone include infaunal polychaetes and nemerteans, large sand crabs, and the pismo clam (*Tivela stultorum*).

Species assemblage exhibits a large amount of temporal and spatial patchiness. Spatial patchiness can be attributed to the physical shape, contour, slope and composition of the shoreline. Manmade structures, areas of pooling water, drainage channels, lees of headlands, and vertical profile of the beach can all influence distribution (Thompson et al. 1993a). Seasonal variability in abundance is evident in certain species. For example, sand crabs are abundant in the summer and fall and virtually absent during the winter months (Thompson et al. 1993a). Hydrodynamics plays a key role in recruitment success of pelagic spawning invertebrates. Diehl et al. (2007) found that the sand crab (*Emerita analoga*) recruitment pattern in the Southern California Bight was similar between years examined. This suggests that the oceanographic cell south of Point Conception may yield a relatively consistent spatial recruitment pattern from year to year in contrast to northerly populations (Diehl et al. 2007).

6.1.1.3 Rocky Subtidal

Rocky subtidal habitats along the Southern California coast are patchily distributed and often fragmented by long stretches of sand. The Southern California islands constitute a substantial fraction of the subtidal rocky habitat that exists in the Southern Study Area (Stephens et al. 2006). The primary rock type is sedimentary, which can be composed of sandstone, mudstone, or shale (Stephens et al. 2006). Shallow rocky subtidal habitats of the Southern Study Area include fully submerged, high-relief folded sandstone outcroppings, low-relief sloped rocky platforms, and boulder or cobble fields. The California islands consist of high relief volcanic reefs with walls, ledges, caves, and pinnacles (USDOD, NOAA 2008).

Depth and wave action are important influential factors of species distribution. Growth rate of filtering organisms tends to be greater in areas with higher wave energy (Menge 1992; Mcquaid and Lindsay 2000). Bottom surge produced by passing swells can dictate species assemblage. Large swells in shallow areas can remove weaker motile and sessile organisms and increase suspended sediments. Suspended sand can act as an abrasive that scours organisms with each passing wave, or can settle out of the water column and bury organisms on the surface of the rock (Menge et al. 1994; Nelson et al. 2008). Suspended sediments can also inhibit light penetration, negatively affecting macrophytes (Nelson et al. 2008). These effects are intensified during storm conditions.

Similar to rocky intertidal zones, subtidal rocky reefs consist of mainly epifaunal sessile species of macrophytes and invertebrates. These sessile organisms do not actively forage; they rely on water movement for supply of nutrients and food. Motile invertebrates inhabiting these areas typically are algal grazers that can withstand strong currents and wave velocities.

The communities of two rock pinnacles (Diablo and Nifty Rocks) located in the Santa Barbara Channel (less than 30 m) were examined and several algal species were observed including filamentous red algae (*Bossiella*), encrusting algae (*Lithothamnion*), green clump algae, and brown algae (Continental Shelf Associates Inc 2005). The six most dominant taxa on the rock outcrops included *Corynactis californica*, *Chthamalus* spp., barnacles (*Balanus* spp.), *Anthopleura xanthogrammica*, *Ophiothrix spiculata*, and mussels (*Mytilus californianus*) (Continental Shelf Associates Inc 2005). Anemones (*Anthopleura* spp.) were also common (Continental Shelf Associates Inc 2005).

Zonation of epifaunal species tends to be more vertical in orientation and depth dependent in rocky subtidal areas, as opposed to the dramatic horizontal zonation observed in the intertidal zone. In general the tops of high-to-medium-relief rocky structures are dominated by encrusting bivalves such as rock oysters and mussels. In mid to lower zones of the outcrop, patches of encrusting bryozoans, gorgonians, stony corals, and rock scallops are typical. Near the bottom of the structure fewer species are present, but occasional stony corals, gorgonians, sponges, barnacles, and sea urchins can be found (Stephens et al. 2006). Both red and purple urchins (*Strongylocentrotus purpuratus* and *S. franciscanus*) are common in subtidal rocky reef habitats, but tend to occupy different depth ranges. For example, at Santa Catalina Island purple urchins are most abundant in shallow depths (less than 5 m), while red urchins are found at deeper intermediate depths (greater than 5 m) (Thompson et al. 1993a). Purple urchins can withstand greater wave surge than red, therefore purple urchins are found at shallower depths (Thompson et al. 1993a).

Giant kelp (*Macrocystis pyrifera*) easily colonizes hard substrates of rocky platforms; therefore, kelp forests are typically associated with nearshore subtidal rocky habitat. Kelp provides increased vertical structure and complexity to rocky subtidal habitats (Schiff et al. 2000). *M. pyrifera* is the most common species of kelp occurring in the Southern Study Area and grows at depths between 5 to 30 m. Growth of giant kelp is limited by light penetration (Schiff et al. 2000). Kelp beds in Southern California are patchily distributed. Larger forests can be found in the Santa Barbara area, on the Palos Verdes Shelf, near Point Loma, and around the Channel

Islands (Schiff et al. 2000). *M. pyrifera* forms the surface canopies of these habitats. There are several species of smaller kelp and red, green, and brown macroalgae forming a sub-canopy. Encrusting and turf algae typically occur on the rock surface. Offshore giant kelp beds in Southern California are typically composed of elk kelp (*Pelagophycus porra*), which can grow in depths up to 30 m (Stephens et al. 2006). Kelp forests are diverse communities that support an intricate food web. For a detailed description of food webs in giant kelp forests see Graham (2004) and Graham et al. (2008). Also [see Chapter 5](#) for further discussion of macrophytes.

There are four main groups of invertebrate consumers in kelp forests: grazers, detritivores, planktivores, and carnivores (Graham et al. 2008). Planktivores and detritivores are successful in rocky reef and kelp habitats due to the detrital matter produced by giant kelp and the consistent supply of phytoplankton and zooplankton. Species of planktivores and detritivores include tunicates, sponges, anemones, bryzoans, gastropod and bivalve mollusks, annelids, gorgonians, echinoderms (sea cucumbers), and crustaceans (i.e. mysids and caprellid amphipods) (Graham et al. 2008).

Erect frondose algae found in kelp forests support a diverse community of grazers. Grazing species include echinoderms (urchins and sea stars), gastropods, and crustaceans (isopods, amphipods, shrimps, hermit crabs, and spider crabs) (Graham et al. 2008). Some of these grazing species are capable of consuming both plant and detrital material. Four notable species of sea urchins occur in high densities in the Southern Study Area: the purple urchin (*Strongylocentrotus purpuratus*), the red urchin (*S. franciscanus*), the white urchin (*Lytechinus anamesus*), and the crowned urchin (*Centrostephanus coronatus*) which is only found south of Point Conception. Abalone species include green (*Haliotis fulgens*), pink (*Haliotis corrugata*), red (*Haliotis rufescens*), and white (*Haliotis sorenseni*). Other predominant grazing taxa include gastropods *Lithopoma* spp. and *Norrisia* spp., and the sea star *Asteria miniata*. Patton et al. (1994) found that adult giant kelp plants were more common on lower-relief rocky substrates (hard substrate lying less than 1 m above the surrounding sand) than on high relief. Grazing invertebrates and fish were more abundant on kelp beds located on high relief structures containing more sheltering crevices (Patton et al. 1994).

Due to the high abundance of grazers and planktivores, carnivorous invertebrates such as gastropods, crustaceans, sea stars, and octopi forage on these populations. Predaceous sea stars like the sunflower star (*Pycnopodia helianthoides*) feed on sessile bivalves and grazing gastropods. Octopi also voraciously feed on grazing gastropod species. Larger crustaceans such as cancer crabs and California spiny lobster (*Panulirus interruptus*) prey on bivalves, gastropods, and sea urchins. These primary predators play a key role in maintaining populations of grazers and patchy distribution of sessile fauna. Without this top-down control from primary predators, increased grazing from species such as urchins can result in habitat degradation. Many shallow reefs heavily grazed by sea urchins have less giant kelp and greatly reduced species diversity (USDOC, NOAA 2008).

Species capable of employing multiple feeding strategies can have substantial positive and negative effects on kelp and rocky subtidal habitats. For example, in kelp forests dense aggregations of reef-building bivalves and certain gastropods can enhance structural complexity

of rocky reef surfaces (Graham et al. 2008). Conversely, Patton et al. (1995) found that gorgonians and sea cucumbers able to consume both detritus and plankton can carpet a habitat to the point of excluding other sessile species, including giant kelp.

Loss of kelp in rocky subtidal habitats may result in several notable consequences on the food web (Graham et al. 2008). Loss of kelp may be due to overgrazing, invasive species, temperature regime shifts, storm events, low nutrients, and other environmental factors. Kelp canopies are sensitive to the oceanographic climate because they rely upon high nutrient content in the water column (Vilchis et al. 2005). Oceanic warming has resulted in decreased nutrients in the surface waters and can be correlated to reduction in kelp biomass (Vilchis et al. 2005). Habitat and trophic linkages in kelp forests are currently growing fields of research. Certain species are more vulnerable to kelp loss than others. Sea urchins are capable of surviving in the complete absence of giant kelp for several decades (Harrold and Pearse 1987). However, abalone tends to decrease in population size following (Harrold and Pearse 1987) episodic deforestation events in Southern California, suggesting an important habitat linkage (Graham 2004).

6.1.1.4 Sandy Subtidal

The dominant bottom type in the Southern California Bight consists of unconsolidated sediments (sand and mud sediments) (Schiff et al. 2000; Cochran et al. 2003; Edwards et al. 2003). Cochran et al. (2003) examined four locations around the northern Channel Islands via side scan sonar and diver observations and found the major benthic habitat to be “shelf soft bottom” (>80% at all sites; [figure 6.1](#)). For descriptions of individual sites, please refer to the full document available online (<http://geopubs.wr.usgs.gov/open-file/of03-85/>). Inner shelf sediments (typically less than 30 m) are dominated by coarse sand with a high carbonate fraction (Schiff et al. 2000). Stability of sandy sediments tends to increase with depth. Regions of sandy seabed are typically smooth. Areas nearer to shore may exhibit low relief sand ripples, which provide evidence for the frequent movement and localized transport of sediments (Edwards et al. 2003). Many sandy nearshore habitats in the Channel Islands Sanctuary have relatively steep slopes with coarse shell debris. Stable sand habitats with fine grain sediments are generally limited to sheltered coves at canyon mouths, such as those found around Santa Cruz Island.

Sandy subtidal bottom in shallower depths (less than 10 m) is commonly dominated by epifaunal suspension feeders. The harsh physical environment of the shallower waters provides partial refuge from predators (Thompson et al. 1993a). In deeper water there tends to be a shift in assemblage to infaunal species (due to stability of the sediments) as well as an increase in carnivores and scavengers. In addition, a shift from small deposit feeding crustaceans (amphipods and ostracods) to polychaetes occurs within the infaunal community as depth increases (Thompson et al. 1993a). Over a larger scale, depth, latitude, and sediment type are important factors determining soft sediment infaunal assemblage. Bergen et al. (2001) found distinct infaunal assemblages associated with shallow (10-32 m), mid (32-115 m), and deepwater (115-200 m) areas of the Southern California shelf.

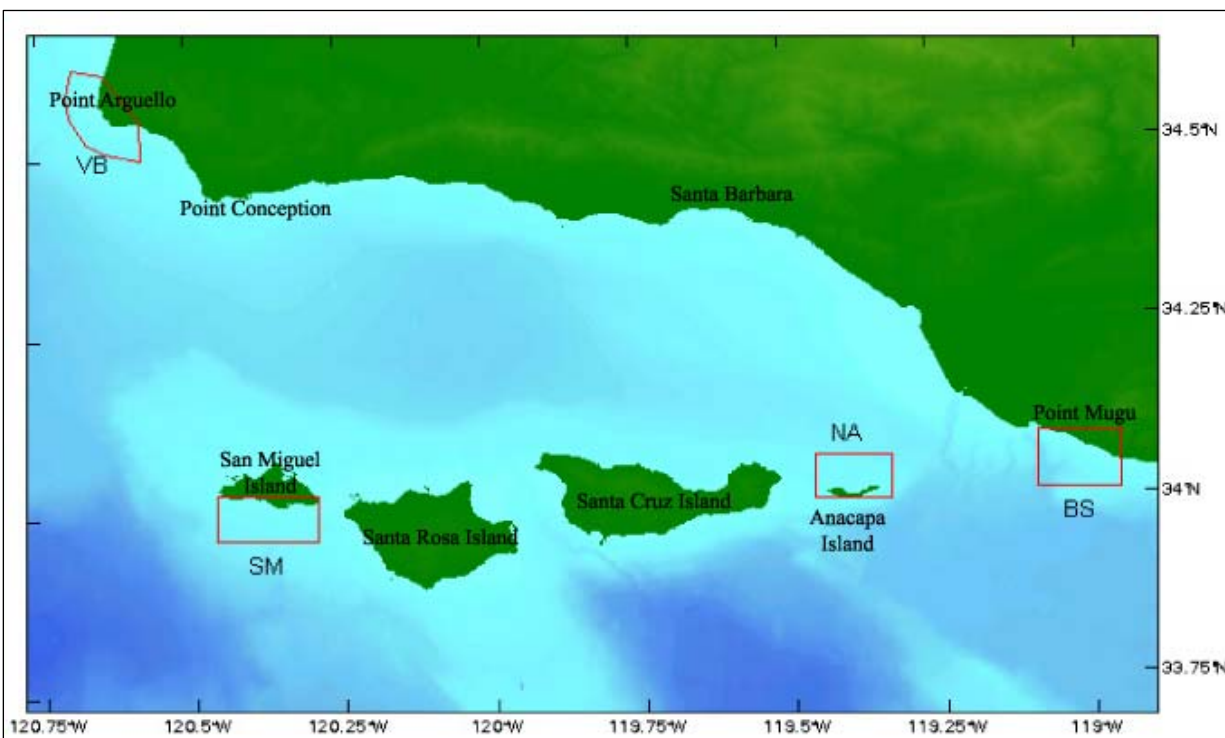

Figure 6.1. Map showing location of the four Marine Ecosystem Response Project, MERRP, study areas surrounding the Santa Barbara Channel; Vandenberg reserve (VA), Big Sycamore State reserve (BS), North Anacapa (NA), and South San Miguel (SM).

<http://geopubs.wr.usgs.gov/open-file/of03-85/figure1.html>

Epifaunal and infaunal organisms commonly found in sandy subtidal bottoms of the Southern Study Area include sea stars (*Astropecten* spp. and *Pisaster* spp.), amphipods (*Paraphoxus* spp. and *Ampelisca* spp.), gastropods (*Nassarius* spp., *Olivella* spp., and *Polinices* spp.), sand dollars (*Dendraster* spp.), hermit crabs (*Holopagurus* spp.), sea pens (*Stylatula* spp.), nudibranchs, brachyuran crabs, sea anemones, bivalves (*Tivela* spp., *Tellina* spp., and *Macoma* spp.), brachiopods (*Glottidia* spp.), and polychaetes (*Spiophanes* spp., *Mediomastus* spp., and *Diopatra* spp.). Thompson et al. (1993b) found the mainland shelf of the Southern California Bight was dominated by a sea urchin (*Lytechinus pictus*) and a prawn (*Sicyonia ingentis*). Edwards et al. (2003) observed that the epifaunal assemblage on the inner shelf west of Playa del Ray consisted of urchins, sea stars, and sea pens. Allen et al. (2007) found a similar mix of species on the mid-depth (50-100 m) shelves throughout the Southern California Bight.

Shallow infaunal communities are highly investigated in areas of degraded or polluted sediments (i.e. near outfalls and discharge sites). Several species (particularly marine worms) have been examined as bio-indicators of disturbed or degraded conditions. Diener et al. (1995) monitored the infaunal assemblage around an ocean outfall site off the coast of Huntington and Newport Beach over a 5-year period. Abundance data showed a pattern of enhancement centered at the outfall (Diener et al. 1995). Absence of depressed species diversity suggested that outfall-related stresses were not significantly affecting the community (Diener et al. 1995). Zmarzly et al.

(1994) found localized effects on the stability of infaunal communities around an outfall sight off Point Loma. However, on the whole the invertebrate communities near outfalls in the Southern California Bight account for more biomass and have higher species diversity than they did during the height of pollution during the 1970s; though they still differ from unpolluted areas (Allen et al. 2007).

Benthic foraminifers are one-celled protists that can be found in soft sediments. Foraminifers make skeletons for themselves that often resemble larger mollusk shells. For this reason they are often referred to as one-celled mollusks. Recently foraminifers have become the subject of ocean pollution studies possibly due to their tolerance of low-oxygen conditions. McGann et al. (2003) found that foraminifers are important bio-indicators of degraded soft sediment habitat located near sewage discharge sites in Santa Monica Bay.

Small invertebrates burrow and overturn the upper layer (typically less than 10 cm) of subtidal soft sediments to forage for food as well as to create sheltering burrows. This continual sediment disturbance is known as bioturbation. Edwards et al. (2003) observed from side-scan sonar surveys of inner shelf sandy sea floors west of Playa del Ray open burrows indicative of infaunal bioturbation. The effects of the bioturbation layer and associated infaunal species assemblage are often studied in stressed and polluted marine ecosystems. Contaminants including DDT and PCBs located in the subsurface sediments of the Palos Verdes shelf, which have accumulated over decades from treated wastewater discharge, undergo resuspension and redistribution via bioturbation of the infaunal benthos (Stull et al. 1996). The bioturbation layer of the annelid and mollusk assemblage at Palos Verdes shelf reaches up to 35 cm deep into the sediments (Stull et al. 1996).

6.1.1.5 Embayment Assemblage

An embayment is a semi-closed body of water that is somewhat protected as opposed to coastline exposed to the open ocean. These areas are tidally active and typically have a different invertebrate assemblage in comparison to exposed coastal habitats. Coastal embayments in Southern California include naturally occurring lagoons, man-made harbors, and estuaries. The condition of these habitats in Southern California ranges from pristine to degraded (Thompson et al. 1993a). Embayments that exist along the coastline of the Southern Study Area include Mugu Lagoon, Anaheim Bay, Alamitos Bay, Mission Bay, Ventura Marina, Marina del Rey, Los Angeles Harbor, Long Beach Harbor, and San Diego Bay. Estuaries and lagoons located in the Southern Study Area are considerably smaller (less than 2 km²) than those found to the north or on the east coast of the United States (Schiff et al. 2000). These bodies of water tend to have little natural runoff, except during winter storms, where salinity can decrease dramatically (Schiff et al. 2000). In contrast, during hot dry periods estuaries can become hypersaline (Schiff et al. 2000).

Embayments may host a wide variety of habitats, including sandy shore, rocky shore, artificial shore, mud flats, salt marshes, seagrass beds, and subtidal soft and rocky sediments. These habitats typically support diverse communities of plant life and invertebrates, which provide important ecological services to primary predators and early life stages of fish species. Several species of epifaunal macrophytes occur in intertidal and subtidal regions of Southern California's

sheltered coastal waters, including the green algae species *Enteromorpha* spp. and *Ulva* spp. Soft substrates are dominated by infaunal invertebrate communities, while hard substrates tend to attract epifaunal organisms. Invertebrate species include gastropods, polychaetes, bivalves, small and large crustaceans, echinoderms, and sponges. Nonindigenous species (NIS) that exist in Southern California embayments include a spionid polychaete worm *Pseudopolydora paucibranchiata*, a mytilid bivalve *Musculista senhousia*, and a semelid bivalve *Theora lubrica* (Ranasinghe et al. 2005). There is a noted difference in assemblage of intertidal zones associated with the back-bay and outer-bay regions of these coastal areas. For more detailed review of the embayment assemblages that exist in the Southern Study Area see Thompson et al. (1993a).

Salt marsh habitats in the Southern Study Area consist of the Pacific cordgrass (*Spartina foliosa*) and pickleweed (*Salicornia* spp.) and support productive macrofaunal communities. Salt marsh habitat can be found in San Diego Bay, Mission Bay, Upper Newport Bay, Bolsa Chica Lagoon, and Anaheim Bay. In comparison to Atlantic salt marsh habitat, the macrofaunal density of Southern California salt marshes was found to be 3 to 10 times higher (Levin et al. 1998). Dominant macrofaunal species in Southern California salt marshes include oligochaetes, polychaetes, and peracarid crustaceans (Levin et al. 1998).

6.1.2 Deep Benthic Habitats and Assemblages

6.1.2.1 Rocky Substrate Assemblages

In depths greater than 30 m in the Southern Study Area beyond the kelp forests, approximately 3 percent of the sea floor consists of rocky outcrops and rubble (Thompson et al. 1993a). Deep rock bottoms are often located offshore from major headlands and islands, and on the highest parts of undersea ridges, banks, and pinnacles. Rocky areas on the mainland shelf are commonly surrounded by patches or expanses of soft substrate. The offshore regions around the Channel Island shelves, Santa Rosa-Cortes Ridge, and Tanner and Cortes banks are composed of base rock and outcrops covered with a thin layer of fine sediment.

Historically few studies have been carried out examining species composition, due to remoteness and inaccessibility. Recent advances in submersible and underwater imaging technology have led to increased data collection. Species found in deep rocky habitats (105-213 m) include ophiuroids (*Ophiacantha* spp.), gorgonians (*Stenella* spp.), brachiopods (*Terebratulina* spp.), amphipods, ectoprocts, anemones (*Corynactis* spp., *Metridium* spp., and *Paracyathus* spp.), corals (*Lophelia* spp.), crinoids (*Florometra* spp.), and cup corals (Thompson et al. 1993a). Komokoiacean-hydrroid mats are also found encrusting rock surfaces.

There are several factors influencing species distribution and cover, including vertical relief, substrate shape, depth, sedimentation, and food particle flux. Unlike species inhabiting deep-sea soft sediments, species inhabiting deep hard-bottoms are typically suspension feeders, including sponges, corals, gorgonians, anemones, ophiuroids, and crinoids (Thompson et al. 1993a). Suspension feeders are more common on high-relief structures than on low-relief (Thompson et al. 1993a). Epifaunal organisms such as sponges may have commensal relationships with organisms like crinoids and shrimp (Thompson et al. 1993a). Biogenic reefs formed from epifaunal organisms are areas of higher productivity in deep-sea habitats. Sponges, deep-sea

corals, and basket stars increase structural complexity and surface area, and provide microhabitat for other species (Tissot et al. 2006). Love et al. (2007) found the dead skeletons of black coral heavily colonized by corophioid amphipods, sea anemones, brittle stars, and crinoids.

A recent submersible study was conducted by Tissot et al. (2006) of several offshore deep banks (32-320 m) in the Southern California Bight. Structure-forming invertebrates, such as sponges (*Metridium* spp.) and crinoids, were most common in high-to-moderate-relief rocky habitats. Brittle stars and brachiopods were associated with low-relief areas containing more boulders and cobble (Tissot et al. 2006). Black corals and gorgonians were found in low-relief areas of mixed cobble and boulder at depths of 100-225 m.

Edwards et al. (2003) conducted a bottom imaging survey of Santa Monica Bay. Depth ranged from 50 to 700 m from the Santa Monica shelf to the Santa Monica Canyon. Epifauna such as gorgonians, ophiuroids, asteroids, and holothurians were abundant on the gravel, cobble, and boulder areas of the outer shelf. Rocky outcroppings on the shelf edge off the coast of Malibu (50-100 m) were encrusted with brachiopods and gorgonians.

Deep-sea rocky habitats are vulnerable to the effects of deep-sea fishing, which has increased in recent years (Tissot et al. 2006). Megafaunal invertebrates providing structure and increased complexity are important to deep-sea fish communities. Bottom fishing gear can disturb and destroy such habitat. Slow-growing, long-lived epifaunal species such as gorgonians (sea fans), antipatharians (black corals), scleractinians (stony corals), and hydrocorals are particularly susceptible to habitat degradation from fishing.

6.1.2.2 Soft Sediment Assemblages

Sediment found in the outer shelf (greater than 30 m) is typically composed of finer silty clay, with localized intrusions of coarse sand (Schiff et al. 2000; Edwards et al. 2003). Deep-sea soft sediments have much less vertical relief than hard-bottom habitat. Well over 90 percent of deepwater benthic habitats in the Channel Island Sanctuary consist of fine sands in shallower portions, grading into silt and clay-dominated sediments in deeper portions (USDOC, NOAA 2008). Deep-sea soft sediments of the Southern California Bight can be divided into four major benthic regions: mainland shelves; offshore shelves, ridges, and banks; basin slopes; and basin floors (Thompson et al. 1993a). A majority of the seafloor habitat is considered basin slope. Submarine canyons are topographic features found in the basin slopes. Canyons have coarser sediment and more organic material than the slope habitat (Thompson et al. 1993a).

The majority of the deep sea floor consists of vast expanses of soft sediments and is sparsely populated with epifauna. Differing grain sizes (e.g., gravel, sand, silt, clay) provide distinct habitats to different species of infaunal organisms; however, polychaetous annelids dominate in most regions (Schiff et al. 2000). Each region is thought to have its own macrobenthic assemblage that is generally influenced by physiographic and sedimentologic features. For a detailed description of regional macrofaunal assemblages see Thompson et al. (1993a). Species assemblage is heavily dependent on substrate type and is patchily distributed, and species zonation is not commonly observed. In general, species diversity and productivity are much lower in deep soft sediment habitats than in shallower nearshore locations. Low dissolved

oxygen conditions are observed in many of the basins. Very few organisms exhibit seasonal changes or temporal patterns.

The red ophiuroid brittle star *Amphiodia urtica* and the polychaete *Spiophanesis* spp. are numerically dominant on the outer mainland shelf between 30 and 150 m (Thompson et al. 1993a). On the nearshore upper slope (161-632 m) and lower slope (480-851 m) the polychaetes *Maldone* spp. and *Anobothrus* spp. are commonly found (Thompson et al. 1993a) as well as several species of echinoids, *Alloctrotus fragilis*, *Brissopsis pacifica*, and *Brisaster latifrons* (Thompson et al. 1993b). The gastropod *Mitrella* spp. is abundant in the nearshore basins (627-938 m) (Thompson et al. 1993a). Species found in the offshore basins, slopes, shelves, ridges, and banks (30 – 2571 m) include the polychaete *Chloeia* spp. and *Tharyx* spp., the pelecypod *Parvilucina* spp., and the amphipod *Byblis* spp (Thompson et al. 1993a). Communities of ampeliscid amphipods occur on the continental slope at a depth of approximately 700 m, while polychaete worms are relatively common at approximately 1,000 m depth (Airamé et al. 2003).

A recent benthic study performed by Bergen et al. (2001) found that the infaunal benthic assemblage of soft sediments in the Southern California mainland shelf at mid-depths (32-155 m) was dominated by polychaetes (*Sthenelanelia* spp., *Prionospio* spp. and *Paramage* spp.), horseshoe worms (*Phoronis* spp.), and ostracods (*Euphilomedes* spp.). Deepwater (155-200 m) soft sediments on the mainland shelf were dominated by polychaetes (*Spiophanes* spp., *Maldane* spp., *Levinsenia* spp., *Cossura* spp. and *Laonice* spp.) and amphipods (*Ampelisca* spp.) (Bergen et al. 2001). Infaunal benthic abundance and diversity were greatest at mid-depths (32 m – 155 m) due to increased upwelling (Bergen et al. 2001).

Tissot et al. (2006) found that on offshore deep banks (32-320 m) of the Southern California Bight white sea urchins were denser in sandier habitats, whereas fragile sea urchins were more common in muddier habitats. Tissot et al. (2006) states that urchins are often found near patches of detrital kelp. Vetter (1995) found that detritus which accumulates in bottom topographies that act as traps often fuels patches of secondary production. In the bottom of deep canyons like La Jolla Submarine Canyon high densities of leptostracan and amphipod crustaceans are found in such organic debris traps (Vetter 1995). White-plumed anemones and sea pens may be dense in sand and mud-gravel habitats. These species may provide important structure and complexity in the low-relief soft sediment on offshore banks (Tissot et al. 2006).

Deposit, surface detrital, and scavenger feeding are typically the dominant foraging mode of most deep sea invertebrate benthos. It has been suggested that species diversity of deposit feeders in soft sediment deep-sea communities is a function of sediment particle size (Etter and Grassle 1992). A large percentage of deep-sea macrofaunal species forage on foraminifers. Suspension feeders are less common in soft sediment deep-sea areas due to low food flux from decreased flow speed and organic particle concentration, although suspension feeders such as glass sponges (hexactinellids) can be found protruding from the seabed (Beaulieu 2001). These biogenic structures provide hard substrate for adherence of other epifaunal organisms.

Species living in deep basins are adapted to live in lower-oxygen or hypoxic conditions in comparison to their shallow water counterparts. For example the octopus *Octopus californicus*

that lives in the Santa Barbara basin at depths of 500 m is able to regulate its oxygen consumption to the limit of detectable oxygen partial pressures (Seibel and Childress 2000).

6.1.2.3 Chemosynthetic Communities

Certain benthic communities found in deeper waters of the Southern California Bight, including the oil seeps of the Santa Barbara Channel, are thought to rely on chemosynthetic primary production (Geesy 1993). Mats of chemosynthetic bacteria (*Beggiatoa*) can be found on the basin sea floor in sulfide-rich sediments. Sulfide is oxidized by the bacteria into elemental sulfur (Geesy 1993). Infaunal organisms such as nematodes consume these bacteria. Two species of infaunal clams inhabiting the sulfide-rich sediments of the Santa Barbara Basin have a symbiotic relationship with chemosynthetic bacteria living in their gills (Geesy 1993). The chemosynthetic bacteria provide these clams with fixed carbon via aerobic oxidation (Geesy 1993).

Chemosynthetic communities can be associated with whale skeletons in deep-sea habitats (Feldman et al. 1998). Chemosynthetic bacteria and tube worms have been observed around whale carcasses in the Southern California Bight. This has led to the hypothesis that whale falls serve as stepping stones for faunal dispersal between seep and vent communities (Feldman et al. 1998).

6.2 COMMERCIAL AND RECREATIONALLY IMPORTANT SPECIES

Several invertebrate species found in the Southern Study Area are important commercial and recreational fisheries. California spiny lobsters (*Panulirus interruptus*) are commercially and recreationally trapped in coastal waters. Lobsters are typically harvested in rocky areas with kelp in depths of 30 m or less (USDOC, NOAA 2008). In comparison to northern regions, the Southern Californian kelp forest has maintained a commercial and recreational sea urchin fishery due to lower levels of natural predation in the absence of the sea otter (Graham et al. 2008). Schiff et al. (2000) reported that red sea urchin (*Strongylocentrotus franciscanus*) was one of the most valued fisheries in the late 1980s. Since 1988 landings of red sea urchin have decreased (Schiff et al. 2000).

Abalone (*Haliotis* spp.) was heavily overfished (commercially and recreationally) in the 1970s and 1980s in the Southern California region. Abalone populations have since decreased dramatically, perpetuating a moratorium on all fishing since May of 1997 (Schiff et al. 2000). There is a dive fishery that exists in Southern California for warty sea cucumbers (*Parastichopus parvimensis*), while trawlers primarily take the California sea cucumber (*P. californicus*). Abundance of the warty sea cucumber decreased in the mid-1990s throughout the Channel Islands within 3 to 6 years after marine reserves were opened to fishing (Schroeter et al. 2001).

Spot and ridgeback prawn (*Pandalus platyceros* and *Sicyonia ingentis*) are both important commercial ground fisheries in Southern California, especially in the Santa Barbara port area (Hill et al. 1999). Ground trawling is the primary method of harvest, although spot prawn are often caught with traps (Hill et al. 1999). The rock crab fishery is made up of three species: yellow rock crab (*Cancer anthonyi*), brown rock crab (*Cancer antnarius*) and red rock crab (*Cancer productus*). Approximately 95 percent of the landings in this fishery come from Southern California, although rock crabs inhabit the nearshore waters of the entire State

(USDOC, NOAA 2008). California mussels (*Mytilus californianus*), found in the rocky intertidal zone, are often harvested recreationally.

6.3 THREATENED AND ENDANGERED SPECIES

The white abalone (*Haliotis sorenseni*), a marine shellfish, was listed as an endangered species throughout its range along the Pacific Coast (Point Conception, California, United States, to Punta Abreojos, Baja California, Mexico) as of June 2001 (USDOI, USFWS 2009). Surveys conducted in Southern California indicate that there has been a 99 percent reduction in white abalone abundance between the 1970s and today (USDOC, NMFS 2006). Davis et al. (1996) reported that white abalone densities in the Channel Islands declined two orders of magnitude by 1981, and virtually disappeared by the early 1990s. The depleted status of the population is attributed primarily to overharvest by commercial and recreational fisheries (USDOI, MMS 2007). In addition, the abalone population has suffered from the additive effects of withering syndrome, slowed growth, and reproduction enhanced by ocean warming (Vilchis et al. 2005).

Black abalone (*Haliotis cracherodii*) has been listed as endangered by the NMFS since January 2009. The decline of the population in the Southern Study Area is attributed to overfishing and withering disease (Miner et al. 2006). Heavy fishing pressure was recorded in the early 1970s and the population dropped to almost zero by the mid 1990s (Vilchis et al. 2005).

Historically, white and black abalone occurred along the mainland coast and at offshore islands and banks. Regulatory measures taken during the past 30 years, including the closure of the white abalone fishery in 1996 and the closure of all abalone fisheries in central and Southern California in 1997, have proven inadequate for the recovery (USDOC, NMFS 2006). Protected marine areas or marine reserves are thought to aid in the restoration of abalone populations (Rogers-Bennett et al. 2002).

White and black abalone are found in open, low- and high-relief rock or boulder habitat. White abalones are reported to be most abundant at depths of 25 to 30 m. Both species are long-lived, slow-moving bottom dwellers. Abalones are broadcast spawners and have variable recruitment rates. Due to these life history factors they are believed to be particularly susceptible to the pressures imposed by intense commercial and recreational fishing. The inadequate recovery of this species is believed to be caused by insufficient reproducing adult densities; therefore repeated recruitment failure has been observed (USDOC, NMFS 2006).

6.4 SUMMARY AND DATA GAPS

Achieving a greater understanding of oceanographic-onshore linkages and effects of ocean processes on rocky intertidal and subtidal ecosystems is difficult, and will increasingly involve more extensive use of remote sensing (Schiel 2004). Better satellite imagery will be a great aid in achieving more accurate data on sea surface temperature and productivity (Schiel 2004). Mapping results from studies onto oceanographic features will provide new insights into structuring processes of benthic communities (Schiel 2004).

Menge (2000) suggests that further investigation of top-down and bottom-up ecological processes in rocky intertidal habitats is needed. Understanding of these processes can be important in revealing determinants of community structure. Increased attention by researchers and of funding agencies to benthic–pelagic coupling would dramatically enhance understanding of the dynamics of coastal ecosystems.

The large differences in benthic invertebrate recruitment rates across biogeographic scales highlight the need for a better understanding of larval response to ocean circulation patterns (Broitman et al. 2008). For example, by extending the spatial and temporal scales beyond that of previous studies investigating larval barnacle and mussel recruitment rates, an improved understanding of the extent of biogeographic regions would result. This would lead to better conservation and management (Broitman et al. 2008).

Deep-sea habitat exploration and characterization are an important future research need especially when considering the effects of anthropogenic threats (i.e. increased deep-sea fishing, oil and gas exploration, and ocean warming). Little is known about deep-sea habitats, as they are remote environments. Without better understanding of these ecosystems, assessment of impacts will be difficult.

6.5 LIST OF LITERATURE CITED—BENTHOS

- Airamé, S., S. Gaines and C. Caldw. 2003. Ecological linkages: Marine and estuarine ecosystems of central and Northern California. U.S. Dept. of Commerce, National Oceanic and Atmospheric Administration and National Ocean Service. P. 164.
- Allen, M.J., T. Mikel, D. Cadien, J.E. Kalman, E.T. Jarvis, K.C. Schiff, D.W. Diehl, S.L. Moore, S. Walther, G. Deets, C. Cash, S. Watts, D.J. Pondella II, V. Raco-Rands, C. Thomas, R. Gartman, L. Sabin, W. Power, A.K. Groce and J.L. Armstrong. 2007. Southern California Bight 2003 Regional Monitoring Program: IV. Demersal Fishes and Megabenthic Invertebrates. Southern California Coastal Water Research Project. Costa Mesa, CA.
- Barry, J., C. Baxter, R. Sagarin and S. Gilman. 1995. Climate-related, long-term faunal changes in a California rocky intertidal community. *Science* 267(5198):672-675.
- Beaulieu, S.E. 2001. Life on glass houses: Sponge stalk communities in the deep sea. *Marine Biology* 138(4):803-817.
- Bergen, M., S.B. Weisberg, R.W. Smith, D.B. Cadien, A. Dalkey, D.E. Montagne, J.K. Stull, R.G. Velarde and J.A. Ranasinghe. 2001. Relationship between depth, sediment, latitude, and the structure of benthic infaunal assemblages on the mainland shelf of Southern California. *Marine Biology* 138(3):637-647.
- Blanchette, C., B. Broitman and S. Gaines. 2006. Intertidal community structure and oceanographic patterns around Santa Cruz Island, CA, USA. *Marine Biology* 149(3):689-701.

- Blanchette, C.A. and S.D. Gaines. 2007. Distribution, abundance, size and recruitment of the mussel, *Mytilus californianus*, across a major oceanographic and biogeographic boundary at Point Conception, California, USA. *Journal of Experimental Marine Biology and Ecology* 340(2):268-279.
- Blanchette, C.A., D.V. Richards, J.M. Engle, B.R. Broitman and S.D. Gaines. 2005. Regime shifts, community change and population booms of keystone predators at the Channel Islands. In: Garcelon, D.K. and C.A. Schwemm, eds. *Proceedings of the Sixth California Islands Symposium*. National Park Service Technical Publication CHIS-05-01. Pp. 435-442
- Blanchette, C.A., E.A. Wieters, B.R. Broitman, B.P. Kinlan and D.R. Schiel. 2009. Trophic structure and diversity in rocky intertidal upwelling ecosystems: A comparison of community patterns across California, Chile, South Africa and New Zealand. *Progress in Oceanography* 83:107-116.
- Broitman, B., C. Blanchette, B. Menge, J. Lubchenco, C. Krenz, M. Foley, P. Raimondi, D. Lohse and S. Gaines. 2008. Spatial and temporal patterns of invertebrate recruitment along the West Coast of the United States. *Ecological Monographs* 78(3):403-421.
- Bullard, A.M. 2005. Macrophyte community structure and productivity of two Southern California rocky shores. California State University, Fullerton.
- Cochrane, G.R., N.M. Nasby, J.A. Reid, B. Waltenberger and K.M. Lee. 2003. Nearshore benthic habitat GIS for the Channel Island National Marine Sanctuary and Southern California state fisheries reserves Volume I. U.S. Geological Survey Version 1.0. Open-file Report 03-85: <http://geopubs.wr.usgs.gov/open-file/of03-85/>.
- Continental Shelf Associates Inc. 2005. Survey of invertebrate and algal communities on offshore oil and gas platforms in Southern California. U.S. Dept. of the Interior, Minerals Management Service and Pacific OCS Region. MMS OCS 2005-070.
- Davis, G.E., P.L. Haaker and D.V. Richards. 1996. Status and trends of White abalone at the California Channel Islands. *Transactions of the American Fisheries Society* 125(1):42-48.
- Diehl, J., R. Toonen and L. Botsford. 2007. Spatial variability of recruitment in the sand crab *Emerita analoga* throughout California in relation to wind-driven currents. *Marine Ecology Progress Series* 350:1-17.
- Diener, D.R., S.C. Fuller, A. Lissner, C.I. Haydock, D. Maurer, G. Robertson and T. Gerlinger. 1995. Spatial and temporal patterns of the infaunal community near a major ocean outfall in Southern California. *Marine Pollution Bulletin* 30(12):861-878.
- Dugan, J., D. Hubbard and M. Lastra. 2000a. Burrowing abilities and swash behavior of three crabs, *Emerita analoga* Stimpson, *Blepharipoda occidentalis* Randall, and *Lepidopa californica* Efford (*Anomura*, *Hippoidea*), of exposed sandy beaches. *Journal of Experimental Marine Biology and Ecology* 255(2):229-245.

- Dugan, J., D. Hubbard, D. Martin, J. Engle, D. Richards, G. Davis, K. Lafferty and R. Ambrose. 2000b. Macrofauna communities of exposed sandy beaches on the Southern California mainland and Channel Islands. In: Proceedings of the Fifth California Islands Symposium, April 1999, Santa Barbara, CA.
- Edwards, B.D., P. Dartnell and H. Chezar. 2003. Characterizing benthic substrates of Santa Monica Bay with seafloor photography and multibeam sonar imagery. *Marine Environmental Research* 56(1-2):47-66.
- Engle, D., R. Ambrose, P. Raimondi, S. Murray, M. Wilson and S. Sapper. 1997. Rocky Intertidal Resources in San Luis Obispo, Santa Barbara, and Orange Counties. U.S. Dept. of the Interior and Minerals Management Service. MMS OCS Study 98-0011.
- Engle, J., M.D. Hubbard, and D. Farrar. 2001. Rocky intertidal resource dynamics at Point Loma, San Diego County, California. U.S. Dept. of the Interior, Minerals Management Service (MMS) and Pacific OCS Region. MMS OCS Study 2001-016. 78 pp.
- Etter, R.J. and J.F. Grassle. 1992. Patterns of species-diversity in the deep-sea as a function of sediment particle size diversity. *Nature* 360(6404):576-578.
- Feldman, R., T. Shank, M. Black, A. Baco, C. Smith and R. Vrijenhoek. 1998. *Vestimentiferan* on a whale fall. *Biological Bulletin* 194(2):116-119.
- Geesy, G.G. 1993. Microbiology. In: Dailey, M., D. Reish and J. Anderson. *Ecology of the Southern California Bight: A synthesis and interpretation*. University of California Press, Berkeley. Pp. 190-232.
- Glover, A.G. and C.R. Smith. 2003. The deep-sea floor ecosystem: Current status and prospects of anthropogenic change by the year 2025. *Environmental Conservation* 30(3):219-241.
- Graham, M. 2004. Effects of local deforestation on the diversity and structure of Southern California Giant Kelp Forest Food Webs. *Ecosystems* 7(4):341-357.
- Graham, M., B. Halpern and M. Carr. 2008. Diversity and dynamics of California subtidal kelp forests. In: McClanahan, T. and G. Branch. *Food webs and the dynamics of marine reefs*. Oxford University Press, Oxford, England.. Pp. 103-134.
- Harrold, C. and J. Pearse. 1987. The ecological role of echinoderms in kelp forests. In: Jangoux, M. and J.M. Lawrence. *Echinoderm studies 2*. Balkema Press, Rotterdam, Netherlands. Pp. 137-233.
- Hill, K., D. Aseltine-Neilson, M. Dege, M. Erickson, P. Haaker, K. Karpov, K. Oda, D. Ono, S. Owen, C. Pattison, I. Taniguchi, D. Thomas, J. Ugoretz, R. Warner, D. Wilson-Vandenberg and M. Yaremko. 1999. Review of some California fisheries for 1998: Pacific sardine, Pacific mackerel, Pacific herring, market squid, sea urchin, groundfishes, swordfish, sharks, nearshore finfishes, abalone, Dungeness crab, prawn, ocean salmon, White Seabass, and recreational. *California Cooperative Oceanic Fisheries Investigations Reports* 40:9-24.

- Jennings, S., J. Pinnegar, N. Polunin and K. Warr. 2001. Impacts of trawling disturbance on the trophic structure of benthic invertebrate communities. *Ecology Progress Series* 213:127-142.
- Levin, L.A., T.S. Talley and J. Hewitt. 1998. Macrobenthos of *Spartina foliosa* (Pacific cordgrass) salt marshes in Southern California: Community structure and comparison to a Pacific mudflat and a *Spartina alterniflora* (Atlantic smooth cordgrass) marsh. *Estuaries* 21(1):129-144.
- Love, M., M. Yoklavich, B. Black and A. Andrews. 2007. Age of Black coral (*Antipathes dendrochristos*) colonies, with notes on associated invertebrate species. *Bulletin of Marine Science* 80(2):391-399.
- McGann, M., C.R. Alexander and S.M. Bay. 2003. Response of benthic foraminifers to sewage discharge and remediation in Santa Monica Bay, California. *Marine Environmental Research* 56(1-2):299-342.
- Mcquaid, C. and T. Lindsay. 2000. Effect of wave exposure on growth and mortality rates of the mussel *Perna perna*: Bottom up regulation of intertidal populations. *Marine Ecology Progress Series* 206:147-154.
- Menge, B. 1992. Community regulation: Under what conditions are bottom-up factors important on rocky shores? *Ecology* 73(3):755-765.
- Menge, B., E. Berlow, C. Blanchette, S. Navarrete and S. Yamada. 1994. The keystone species concept: Variation in interaction strength in a rocky intertidal habitat. *Ecological Monographs* 64(3):250-286.
- Menge, B.A. 2000. Top-down and bottom-up community regulation in marine rocky intertidal habitats. *Journal of Experimental Marine Biology and Ecology* 250(1-2):257-289.
- Miner, C.M., J.M. Altstatt, P.T. Raimondi and T.E. Minchinton. 2006. Recruitment failure and shifts in community structure following mass mortality limit recovery prospects of Black abalone. *Marine Ecology Progress Series* 327:107-117.
- Murray, S., T. Denis, J. Kido and J. Smith. 1999. Human visitation and the frequency and potential effects of collecting on rocky intertidal populations in Southern California marine reserves. *Reports of California Cooperative Oceanic Fisheries Investigations* 40:100-106.
- Nelson, P.A., D. Behrens, J. Castle, G. Crawford, R.N. Gaddam, S.C. Hackett, J. Largier, D.P. Lohse, K. Mills, P.T. Raimondi, M. Robart, W.J. Sydeman, S.A. Thompson and S. Woo. 2008. Developing wave energy in Coastal California: Potential socio-economic and environmental effects. California Energy Commission, PIER Energy-Related Environmental Research Program & California Ocean Protection Council CEC-500-2008-083.
- Patton, M., R. Grove and L. Honma. 1995. Substrate disturbance, competition from sea fans (*Muricea* sp.) and the design of an artificial reef for giant kelp (*Macrocystis*). In: *Proceedings from the International Conference on Ecological System Enhancement*

Technology for Aquatic Environments, Japan International Marine Science and Technology Federation, Tokyo, Japan. Pp. 47-59.

Patton, M.L., C.F. Valle and R.S. Grove. 1994. Effects of bottom relief and fish grazing on the density of the giant kelp, *Macrocystis*. *Bulletin of Marine Science* 55(2-3):631-644.

Pineda, J. 1994. Spatial and temporal patterns in barnacle settlement rate along a Southern California rocky shore. *Marine Ecology Progress Series* 107:125-125.

Ranasinghe, J.A., T.K. Mikel, R.G. Velarde, S.B. Weisberg, D.E. Montagne, D.B. Cadien and A. Dalkey. 2005. The prevalence of non-indigenous species in Southern California embayments and their effects on benthic macroinvertebrate communities. *Biological Invasions* 7(4):679-686.

Rogers-Bennett, L., P.L. Haaker, K.A. Karpov and D.J. Kushner. 2002. Using spatially explicit data to evaluate marine-protected areas for abalone in Southern California. *Conservation Biology* 16(5):1308-1317.

Roy, K., A.G. Collins, B.J. Becker, E. Begovic and J.M. Engle. 2003. Anthropogenic impacts and historical decline in body size of rocky intertidal gastropods in Southern California. *Ecology Letters* 6(3):205-211.

Schiel, D.R. 2004. The structure and replenishment of rocky shore intertidal communities and biogeographic comparisons. *Journal of Experimental Marine Biology and Ecology* 300(1-2):309-342.

Schiff, K.C., M. James Allen, E.Y. Zeng and S.M. Bay. 2000. Southern California. *Marine Pollution Bulletin* 41(1-6):76-93.

Schoch, G.C., B.A. Menge, G. Allison, M. Kavanaugh, S.A. Thompson and S.A. Wood. 2006. Fifteen degrees of separation: Latitudinal gradients of rocky intertidal biota along the California current. *Limnology and Oceanography* 51(6):2564-2585.

Schroeter, S., D. Reed, D. Kushner, J. Estes and D. Ono. 2001. The use of marine reserves in evaluating the dive fishery for the warty sea cucumber (*Parastichopus parvimensis*) in California, USA. *Canadian Journal of Fisheries and Aquatic Sciences* 58(9):1773-1781.

Seibel, B.A. and J.J. Childress. 2000. Metabolism of *benthic octopods* (*Cephalopoda*) as a function of habitat depth and oxygen concentration. *Deep-Sea Research Part I* 47(7):1247-1260.

Smith, E., D. Fry, H. Fry, J. Speth, A. Rutch and L. Fisk. 1976. Coastal county fish and wildlife resources and their utilization. California Department of Fish and Game, Sacramento, CA.

Smith, J., P. Fong and R. Ambrose. 2006. Long-term change in mussel (*Mytilus californianus Conrad*) populations along the wave-exposed coast of Southern California. *Marine Biology* 149(3):537-545.

- Snelgrove, P. and C. Butman. 1994. Animal-sediment relationships revisited: Cause versus effect. *Oceanography and Marine Biology* 32:111-177.
- Steinbeck, J.R., D.R. Schiel and M.S. Foster. 2005. Detecting long-term change in complex communities: A case study from the rocky intertidal zone. *Ecological Applications* 15(5): 1813-1832.
- Stephens, J., R. Larson and D. Pondella. 2006. Rocky reefs and kelp beds. In: Allen, L., D. Pondella, and M. Horn. *The ecology of marine fishes: California and adjacent waters*. Berkeley, CA: University of California Press. Pp. 227-252.
- Stull, J., D. Swift and A. Niedoroda. 1996. Contaminant dispersal on the Palos Verdes continental margin: I. Sediments and biota near a major California wastewater discharge. *The Science of the Total Environment* 179(1-3):73-90.
- Thompson, B., J.D. Dixon, S. Schroeter and D.J. Reish. 1993a. Benthic invertebrates. In: Dailey, M., D. Reish, and J. Anderson. *Ecology of the Southern California Bight: A synthesis and interpretation*. University of California Press, Berkeley. Pp. 369-458.
- Thompson, B., D. Tsukada and J. Laughlin. 1993b. Megabenthic assemblages of coastal shelves, slopes, and basins off Southern California. *Bulletin of the Southern California Academy of Sciences* 92(1):25-42.
- Tissot, B.N., M.M. Yoklavich, M.S. Love, K. York and M. Amend. 2006. Benthic invertebrates that form habitat on deep banks off Southern California, with special reference to Deep Sea coral. *Fishery Bulletin* 104(2):167-181.
- U.S. Dept. of Commerce, National Marine Fisheries Service (NMFS). 2006. Draft White Abalone recovery plan (*Haliotis sorenseni*). U.S. Dept. of Commerce, National Marine Fisheries Service (NMFS) and National Oceanic and Atmospheric Administration (NOAA).
- U.S. Dept. of Commerce and National Oceanic and Atmospheric Administration (NOAA). 2008. Channel Islands National Marine Sanctuary final management plan/final environmental impact statement. National Marine Sanctuary Program.
- U.S. Dept. of the Interior, U.S. Fish and Wildlife Service (USFWS). 2009. Species reports: Environmental Conservation Online System. Species listed in California based on published population data. Internet website: http://ecos.fws.gov/tess_public/StateListing.do?state=all. Accessed May 2009.
- U.S. Dept. of the Interior, Minerals Management Service (MMS). 2007. Programmatic environmental impact statement for alternative energy development and production and alternative use of facilities on the Outer Continental Shelf. Final environmental impact statement. Vol. II. OCS EIS/EA MMS 2007-046. 342 pp.
- Vetter, E.W. 1995. Detritus-based patches of high secondary production in the nearshore benthos. *Marine Ecology Progress Series* 120(1):251-262.

- Vilchis, L., M. Tegner, J. Moore, C. Friedman, K. Riser, T. Robbins and P. Dayton. 2005. Ocean-warming effects on growth, reproduction, and survivorship of Southern California abalone. *Ecological Applications* 15(2):469-480.
- Zmarzly, D.L., T.D. Stebbins, D. Pasko, R.M. Duggan and K.L. Barwick. 1994. Spatial patterns and temporal succession in soft-bottom macroinvertebrate assemblages surrounding an ocean outfall on the southern San Diego shelf: Relation to anthropogenic and natural events. *Marine Biology* 118(2):293-307.

7. FISH

This chapter provides a review of the information on fish resources found in the major habitats of the Southern Study Area. Fish species can be designated as either pelagic (in the water column), demersal (near the sea floor), or benthic (on the sea floor). The pelagic region is made up of three specific zones, including epipelagic (from surface to depths of 200 m), mesopelagic (depths between approximately 200 m and 1,000 m) and bathypelagic (depths greater than 1,000 m). The benthic zone includes soft-bottom habitat, hard-bottom habitat, and low and high relief features, all of which harbor unique assemblages of fish. In this chapter, zoogeography, essential fish habitat (EFH), spawning grounds, life history information, commercial and recreational fishing, threatened and endangered species, trophic interactions, and future research needs of fish species in the Southern Study Area are addressed.

7.1 ZOOGEOGRAPHY

There is a well-known biogeographic boundary separating two distinctive fish faunal assemblages (a warm-temperate southern component and a cool-temperate northern component) that occurs in the vicinity of Point Conception at about 34.5° N (Horn et al. 2006). The transition zone in this region is where the Oregonian (cooler water) and the Californian (warmer water) biogeographic regions overlap. As a result, the majority (approximately 90 percent) of the over 550 species of marine fishes that inhabit or visit California waters can be found in the Southern Study Area (Cross and Allen 1993). The high species richness in this area is due in part to the complex topography; the convergence of several water masses (e.g., Pacific subarctic, Pacific equatorial, and the North Pacific central), with fish fauna representatives from each source, and the short- and long-term variability in climate (e.g., alternating between El Niño-Southern Oscillation (ENSO) events, La Niña, and neutral conditions) (Cross and Allen 1993; Horn et al. 2006).

While Point Conception is widely recognized as a faunal boundary, with mostly cold-water species found to the north and warm-water species found to the south, species can be found on both sides during different climactic conditions. A trend of warmer ocean surface waters that occurred from the mid-1970s through the strong El Niño conditions of 1997-1998, followed by a rapid change to cooler temperatures and La Niña conditions from late 1998 to early 2001 (Bograd et al. 2000; Horn et al. 2006) affected fish recruitment and, ultimately, altered the composition of some fish assemblages (Love et al. 1985; Love et al. 1986). For instance, during the 1997-1999 El Niño-La Niña cycle (Lynn and Bograd 2002), there were large additions of Panamic fishes, such as deepwater cornetfish (*Fistularia corneta*) and greater sand perch (*Diplectrum maximum*), to the California fish fauna (Lea and Rosenblatt 2000). Changes in the ichthyofauna in California during the 1997-1999 El Niño were perhaps the most dramatic of the twentieth century (Lea and Rosenblatt 2000).

7.1.1 Essential Fish Habitat

The 1996 amendments to the Magnuson-Stevens Fishery Conservation and Management Act (also known as the Sustainable Fisheries Act, hereafter “the Act”) (16 U.S.C. 1801 et seq) established provisions for identifying and protecting habitat essential to the production of federally managed species. This so-called essential fish habitat (EFH) is broadly defined to

include “those waters and substrates necessary to fish for spawning, breeding, feeding, or growth to maturity” (U.S.C. 1802(10)). Marine fish depend on healthy habitats to survive and reproduce. Throughout their lives, fish use many types of habitats including seagrass, salt marsh, coral reefs, rocky intertidal areas, and hard/live bottom areas, among others. Various activities on land and in the water may threaten to alter, damage, or destroy these habitats, thereby affecting the fishery resources that utilize them. The National Marine Fisheries Service (NMFS), regional Fishery Management Councils, interstate Marine Fisheries Commissions, and Federal and State agencies work together to address these threats by identifying EFH for each federally managed fish species and developing conservation measures to protect and enhance those habitats. The Act requires Fishery Management Plans (FMPs) to include identification and descriptions of EFH, descriptions of nonfishing and fishing threats, and suggested measures to conserve and enhance EFH.

Section 305(b)(2) of the Act requires Federal agencies to consult with NMFS and ultimately the Secretary of Commerce on all actions, or proposed actions, authorized, funded, or undertaken by the agency, that may adversely affect EFH. The EFH Guidelines (50 CFR 600.05 - 600.930, published in the Federal Register December 19, 1997, Volume 62, Number 244) outline the process for Federal agencies, NMFS, and the Fishery Management Councils to satisfy the EFH consultation requirement under Section 305(b) (2)-(4) of the Act. As part of the EFH consultation process, the guidelines require Federal action agencies to prepare a written EFH Assessment describing the effects of that action on EFH (50 CFR 600.920(e) (1)). If more than one Federal agency is responsible for Federal action, then the consultation may be fulfilled through a lead agency (e.g., BOEMRE), and only the lead agency is required to prepare an EFH assessment provided proper notification has been provided to NMFS. The Federal agency that is issuing the action (i.e., permit for work) must include in the EFH Assessment: (1) a description of the proposed action; (2) an analysis of the effects, including cumulative effects, of the action on EFH, the managed species, and associated species by life history stage; (3) the Federal agency’s views regarding the effects of the action on EFH; and (4) proposed mitigation if applicable. Federal agencies may incorporate an EFH assessment into documents prepared for other purposes such as Endangered Species Act Biological Opinions, NEPA documents, or public notices.

The Pacific Fishery Management Council (PFMC) manages over 100 species of fish under four Fishery Management Plans (www.pcouncil.org): (1) Coastal Pelagics Fishery Management Plan; (2) Pacific Salmon Fishery Management Plan; and (3) Pacific Groundfish Fishery Management; and (4) Highly Migratory Species. Coastal pelagic species include northern anchovy (*Anchoa* spp.), market squid (*Loligo* spp.), Pacific bonito (*Sarda* spp.), Pacific saury (*Coloabis* spp.), Pacific herring (*Clupea* spp.), Pacific sardine (*Sardinops* spp.), Pacific (chub or blue) mackerel (*Scomber* spp.), and jack (Spanish) mackerel (*Trachurus* spp.). Under the groundfish plan over 64 species of rockfish (Scorpaenidae) are managed including widow, yellowtail, canary, shortbelly, vermilion, bocaccio, chilipepper, cowcod, yelloweye, thornyheads, scorpionfish, and Pacific ocean perch. The groundfish management plan also includes flatfish (soles, starry flounder, turbot, and sanddab), roundfish (lingcod, cabezon, kelp greenling, Pacific cod, Pacific whiting, and sablefish), and sharks and skates (leopard shark, soupfin shark, spiny dogfish, big skate, California skate, and longnose skate). Highly migratory species include tunas (North

Pacific albacore, yellowfin, bigeye, skipjack, and northern bluefin), sharks (common thresher, pelagic thresher, bigeye thresher, shortfin mako, and blue), billfish/swordfish (striped marlin, Pacific swordfish), and dolphinfish.

EFH for coastal pelagic species is based on a specific temperature range that applies to all marine and estuary waters from the West Coast shoreline (and estuaries) to the limits of the exclusive economic zone (EEZ) (PFMC 2008). EFH for groundfish species is defined as all areas from the high tide line (and parts of estuaries) to 3,500 meters (1,914 fathoms) in depth. EFH for highly migratory species is defined by temperature ranges, salinity, oxygen levels, currents, shelf edges, and seamounts.

In addition to designating EFH, the NMFS requires fishery management councils to identify Habitat Areas of Particular Concern (HAPCs) within fishery management plans (PFMC 2008). HAPCs are discrete subsets of EFH that provide extremely important ecological functions or are especially vulnerable to degradation. Councils may designate a specific habitat area as an HAPC based on (1) importance of the ecological function provided by the habitat; (2) extent to which the habitat is sensitive to human-induced environmental degradation; (3) whether, and to what extent, development activities are, or will be, stressing the habitat type; or (4) rarity of the habitat type. While the HAPC designation does not confer additional protection for or restrictions on an area, it can help prioritize conservation efforts. Healthy populations of fish require not only the relatively small habitats identified as HAPCs, but also other areas that provide suitable habitat functions. Thus, HAPCs alone may not suffice in supporting the larger numbers of fish needed to maintain sustainable fisheries and a healthy ecosystem. A variety of general habitat types have been designated as HAPCs for fishery species in the Pacific Region, including estuaries, canopy kelp, seagrass, rocky reef areas, and others. In addition, a large number of specific areas of interest have also been designated as HAPCs. Examples include specific fishing banks or ledges, seamounts, marine sanctuaries, and fishery conservation areas.

7.1.2 Spawning Grounds

Spawning grounds located in the Southern California Bight are diverse and distributed over the entire region. Many fish species spawn locally in their resident habitat such as estuaries, embayments, rocky intertidal zone, sandy beach, rocky subtidal, and kelp beds. Other species, usually more pelagic in nature, may embark on long migrations to spawning grounds, although several groundfish species do partake in onshore/offshore migrations for reproduction as well.

In the winter, dover sole (*Solea solea*) migrate into deep water to spawn, and then into shallow water during the summer to feed (USDOI, MMS 2001). Scorpionfish (*Scorpaena* spp.) migrate offshore to spawning grounds from May through August. In the fall, Pacific hake (*Merluccius productus*) migrate from feeding grounds off the Pacific Northwest to winter spawning grounds off Southern California and Baja California (Saunders and McFarlane 1997). The California grunion (*Leuresthes tenuis*) has an annual spawning migration toward shallow inshore areas of California throughout the spring and summer. They spawn high up on sandy beaches to avoid predators. In order to reach the highest part of the beach, they migrate during high tides (McKeown 1984). On the other hand, some species, such as kelp bass (*Paralabrax clathratus*)

and garibaldi (*Hypsypops rubicundus*) do not migrate much throughout their lifespan (USDOJ, MMS 2001).

Migration is often timed around hydrodynamic events and focused on features that perpetuate increased primary production (coastal upwelling regions, frontal zones, offshore banks, estuaries). For example, Lynn (2003) found a strong correlation between spatial patterns of sardine (*Sardinops* spp.) eggs and zooplankton biomass off central and Southern California. The inshore distribution of spawning was limited by low temperatures of freshly upwelled waters. An abrupt offshore decrease in zooplankton density was coincident with the offshore boundary of eggs (Lynn 2003). This suggests that sardines have an evolved strategy for spawning ground selection and timing that promotes favorable food supply conditions for larval development (Lynn 2003). Parameters such as sea surface temperature and zooplankton biomass can be used to delineate the boundaries of crucial sardine spawning habitat (Lynn 2003).

Timing of spawning varies by species. Still, it can be generalized that reproductive cycles of species with northern affinities, such as Pacific hake (*Merluccius productus*) and olive rockfish (*Sebastes serranoides*), generally peaks from winter to spring in the Southern California Bight; the reproductive cycle of species with southern affinities, like kelp bass (*Paralabrax clathratus*) and queenfish (*Seriphus politus*), generally peaks from spring to summer (USDOJ, MMS 2001). Some fish species (e.g., splitnose rockfish (*Sebastes diploproa*) and northern anchovy (*Anchoa* spp.)) spawn throughout the year. Spawning periods can also be governed by lunar and diel cycles. California grunion (*Leuresthes tenuis*), for example, spawn on the first few nights following each new and full moon of the spring and summer and queenfish spawn from late afternoon to evening, especially during the first quarter of the moon (USDOJ, MMS 2001).

In addition to productivity, spawning ground location is often associated with areas of preferential larval transport, either dispersal or retention (Cowen 2002). Certain species may spawn in areas where larvae experience low offshore transport and are otherwise retained. Others species, often with longer larval life stages, may utilize currents and eddies for offshore dispersal. Deepwater pelagic species spawn at depth and often have larvae that vertically migrate to surface waters for increased feeding potential (Neighbors and Wilson, Jr. 2006, Moser et al. 2001).

7.2 LIFE HISTORIES

Life history traits are the characteristics of fish species that reflect evolutionary and adaptive responses to the surrounding environment. These traits are what enable the organism to exist in its associated habitat. Life history characteristics include growth, mortality, recruitment, reproduction, life stages, feeding, movement, and behavioral responses. Growth and mortality in fish species are generally correlated. Fish with low natural adult mortality rates grow slowly, mature late, and have low annual reproductive output, whereas species with high natural adult mortality rates tend to be fast growers, mature quickly and have high annual reproductive output (Cross and Allan 1993).

Reproductive mechanisms of fish species include broadcast spawning, egg brooding, and internal fertilization. For the most part, fish species in the Southern California Bight exhibit two modes

of offspring production: direct production of juveniles (after internal fertilization) that are miniature adults, and indirect production of pre-juvenile stages (eggs and larvae) (DeMartini and Sikkell 2006). Most fish species fall into the second category of pre-juvenile stage producers. These fish exhibit four general life stages: egg, larvae, juvenile, and adult. Each of these can be broken down into further detailed sub-stages and duration of each stage varies by species.

Factors that determine diet include body shape, feeding behavior, and capture and feeding mechanisms. Capture and feeding mechanisms may be described as biting, suction and ram feeding, suspension feeding, and pharyngeal jaw crushing (Horn and Ferry-Graham 2006). Trophic categories include herbivores, detritivores, carnivores, and omnivores. The carnivorous group can be broken up into zooplankton feeders, benthic invertebrate feeders, and piscivores (fish-eaters). In the Southern Study Area, zooplankton feeders include anchovies (*Anchoa* spp.) and sardines (*Sardinops* spp). Examples of benthic invertebrate feeders include several ground and flatfish species such as sole (*Solea* spp.). Many of the larger pelagic species found in the Southern California Bight are strictly fish eaters including tuna (*Thunnus* spp.) and striped marlin (*Tetrapturus* spp.) (DeMartini and Sikkell 2006).

7.3 COMMERCIAL AND RECREATIONAL FISHING

There are several commercial and recreational fisheries in the Southern California Bight. Over 100 species of fish are accounted for in the catch composition. Commercial landings for the entire state of California in 2004 totaled 172 million kg (USDOJ, MMS 2007). Commercial fishing techniques include hook and line trolling, harpoon, longline, purse seines, traps, bottom trawl, and gill nets. Purse seining is an important method of fishing for pelagic species, especially northern anchovy, sardine, tunas, mackerel, and bonito. Bottom trawling targets groundfish including rockfish, flatfish, roundfish, and sharks. Many of the highly migratory species, including billfish, tunas, dolphinfish, and sharks, are the target of both recreational and commercial hook and line fisheries, as well as commercial harpooning and longlining. Dotson and Charter (2003) report that popular recreational fish species or species groups from 1959-1998 included albacore, California barracuda, Pacific bonito, calico bass, rockfishes, yellowtail, and yellowfin tuna.

In general, regime shifts have profound effects on fisheries and harvest in the Southern California Bight. This was first observed in catch fluctuations of small pelagic fish (northern anchovies and sardines) in conjunction with El Niño events and the Pacific Decadal Oscillation (PDO) (Mann and Lazier 1996). Similar fluctuation patterns are now emerging for larger-bodied fish such as salmon, various groundfish, and some tuna species (Lehodey et al. 2006). The El Niño event of 1997-98 was partly responsible for significant decline in total commercial landings as compared to previous years (Hill et al. 1999). Elevated temperatures altered seasonal availability of several commercial species (Hill et al. 1999). The delayed onset of seasonal upwelling in spring 2005 and 2006 (Schwing et al. 2006) has been blamed for poor ocean conditions and biological productivity and recruitment failures in several populations (McClatchie et al. 2008). It is not uncommon for fishers to redirect effort on underutilized species during such regime shifts (Hill et al. 1999).

In the Southern Study Area, populations of rockfish species (Scorpaenidae) have exhibited population decline, and accordingly, rockfish conservation and management efforts have intensified in the past several decades. The decline is attributed to additive effects of climate change and fishing pressure (Bennett et al. 2004). Low recruitment success was attributed to warmer seas and declines in zooplankton caused by a positive shift in the PDO coupled with frequent El Niño events in the years following 1977 (Bennett et al. 2004). Dotson and Charter (2003) noted a decrease in recreational rockfish catch since the early 1980s followed by a shift in recreational effort toward less utilized species, including ocean whitefish, California scorpionfish, cabezon, and sanddabs, was observed.

The shark fishery of the Southern California Bight has experienced patterns of boom and bust in the past several decades (Holts et al. 1998). Notably, shark landings off the West Coast decreased by 25 percent in 1998 from earlier years (1980-1988) (Holts et al. 1998). Extremely poor returns of salmon stocks in California have triggered the closure of much of the West Coast salmon fishery (McClatchie et al. 2008).

Understanding the impacts of fishing activities on the ecosystem of the Southern California Bight is a growing field of research. Removal of predators, due to commercial harvest, and the effects of weakened top-down control and ecosystem responses, is a current research focus (Halpern et al. 2006). Bottom fishing and its effects on seafloor habitats of the Pacific Coast, especially those exhibiting high complexity and low recovery time, have been investigated in several studies and have become a management concern (Bellman and Heppell 2007; Jennings et al. 2005). NMFS is engaged in seafloor mapping and furthering the development and definition of EFH designations in all U.S. coastal waters. In addition, marine reserves and conservation areas are becoming popular management methods. For example, Schroeder and Love (2002) found that densities of two species federally listed as overfished (cowcod and bocaccio) were substantially higher in a marine reserve area in Southern California as compared to areas open to fishing.

7.4 THREATENED AND ENDANGERED SPECIES

Endangered and threatened fish species that are listed under the Endangered Species Act (ESA) occurring in the Southern Study Area are the green sturgeon (*Acipenser medirostris*), the tidewater goby (*Eucyclogobius newberryi*), and the Southern California evolutionarily significant unit (ESU) of West Coast steelhead (*Oncorhynchus mykiss*) (Table 7.1).

Table 7.1.

Conservation status of all species of fish found in the Southern Study Area (CA DFG 2009)

Species	Federal Listing	California Listing
Green Sturgeon – southern population <i>Acipenser medirostris</i>	Threatened	none
Steelhead – Southern California populations <i>Oncorhynchus mykiss</i>	Endangered	none
Tidewater Goby <i>Eucyclogobius newberryi</i>	Endangered	none

Green Sturgeon - The green sturgeon is broadly distributed along the West Coast from Mexico to the Bering Sea. Adams et al. (2002) determined that the green sturgeon is composed of two distinct population segments (DPS) that qualify as species under the ESA. Following an updated status review in 2005, NMFS concluded that the northern green sturgeon DPS warranted listing only on the Species of Concern List and proposed that the southern DPS be listed as threatened under the ESA. NMFS published a final rule listing the Southern DPS of the green sturgeon as threatened in 2006.

Adult individuals spend most of their lives in nearshore oceanic waters, bays, and estuaries. Spawning occurs in deep freshwater rivers. Adults migrate into freshwater areas for spawning in late winter. Juveniles stay in freshwater and estuarine areas for 1 to 4 years. Green sturgeon forage in estuaries and bays ranging from San Francisco Bay to British Columbia. Due to the lack of embayments and estuarine habitat, the southern DPS is centered in central and northern regions of California, and individuals occasionally occur in the Southern Study Area. Principal food items include benthic invertebrates such as shrimp, mollusks, and amphipods, although they will also consume small fish (Adams et al. 2002). The decline of the southern DPS of the green sturgeon is primarily related to the reduction of the available spawning area to a limited section of the Sacramento River.

Tidewater Goby - The tidewater goby was listed as endangered in 1994. It is found only in shallow coastal lagoons, stream mouths, and shallow areas of bays in low-salinity waters of California. The decline of the tidewater goby can be attributed to loss of saltmarsh habitat via upstream water diversions, dredging, changes in salinity, pollution, siltation, and urban development (USDOJ, MMS 2007). Competition from the introduced yellowfin goby (*Acanthogobius flavimanus*) is also a potential threat.

Historically the tidewater goby occurred in several California coastal lagoons from San Diego County to Humboldt County. In more recent years it has disappeared from most of these sites. Critical habitat has been designated in San Diego and Orange Counties. Malibu lagoon is a small canyon mouth estuary that is home to the endangered goby (Lafferty et al. 1999; Dawson et al. 2001). Tidewater gobies have been documented in water with salinity levels from 0 to 10 ppt, temperature levels from 1.7 to 22.8°C (35 to 73°F), and water depths from 1.5 to 2.3 m (USDOJ, MMS 2007). This species may enter the marine environment when forced out of the lagoon by strong storms. Primary diet items include small crustaceans, aquatic insects, and mollusks. Spawning occurs year-round with distinct peaks in April and May.

Steelhead - NMFS has listed 16 ESUs of West Coast anadromous salmon species as threatened or endangered. Each ESU is treated as a separate species under the Endangered Species Act. Steelhead are migratory anadromous rainbow trout. The Southern California ESU steelhead inhabits streams and rivers from the Santa Maria River south to Malibu Creek, California (Behnke 1992). Critical habitat for steelhead includes all accessible river reaches and estuarine areas from the Santa Maria Basin to Malibu Creek. In the Point Arguello area, this would include the Santa Ynez River, San Antonio Creek, and the Santa Maria River. Steelhead enter

their natal streams from November to April to spawn. Juveniles migrate to sea usually in spring. Steelhead can migrate extensively at sea.

Adults migrate to freshwater areas to spawn, and the resulting young fish eventually enter marine waters to mature. A number of factors have contributed to the declines in populations of West Coast salmon species over recent decades, including natural conditions (e.g., drought conditions), water management activities (e.g., construction of dams and depletion of water supplies), overharvesting (both recreational and commercial), predation and competition from introduced nonnative species, and changes in water quality (USDOJ, MMS 2007).

7.5 FISHES OF THE PELAGIC ZONE

7.5.1 Epipelagic

The epipelagic zone, the water column covering the shelf and the upper 200 m of water overlying the slope and deep basin, is the largest habitat in the Southern California Bight and the home of 40 percent of the species and 50 percent of the families of fish (Allen and Cross 2006). This area can be further defined as the coastal or neritic epipelagic zone, which refers to the area from the surf zone to the continental shelf break, and the oceanic epipelagic zone, or the areas over the slope and deep basins.

Epipelagic fish are adapted to a habitat void of physical structure or visual reference points. The assemblage is composed of small suspension feeders (e.g., anchovies and sardines) as well as larger predators (e.g., tunas); many of which are commercially harvested. Epipelagic fish typically exhibit schooling behavior and undertake long migrations to foraging areas (typically areas of upwelling) and spawning habitats (PFMC 2005). Fish from this zone represent a mix of permanent residents and periodic visitors. With the exception of several subtropical species, epipelagic fishes have extensive ranges, which cover most of the Pacific Region. Species considered highly migratory in the Pacific Ocean include tunas, swordfish, marlins, sailfish, and oceanic sharks (PFMC 2005).

The majority of the coastal epipelagic zone is beyond the major direct impacts of tidal, wave, beach, and shoreline processes. Many coastal pelagic species are found within a few kilometers of the shore including queenfish (*Seriphus* spp.), California barracuda (*Sphyraena* spp.), speckled sanddab (*Citharichthys* spp.), white croaker (*Genyonemus* spp.), walleye surfperch (*Hyperprosopon* spp.), and salema (*Xenistius* spp.) (Allen and Pondella 2006). Small schooling herbivores in the coastal epipelagic zone include the deepbody and northern anchovy (*Anchoa* spp.), the Pacific sardine (*Sardinops* spp.), and the jack mackerel (*Trachurus* spp.). Schooling predators found over the shelf and at the shelf break include Pacific bonito (*Sarda* spp.), yellowtail (*Seriola* spp.), tuna (*Thunnus* spp.) and Pacific pompano (*Peprilus* spp.). Large solitary predators include sharks and swordfish (Cross and Allen 1993). Movement patterns and data of predators such as the blue shark, salmon shark and shortfin mako sharks in the Southern Study Area can be accessed through the “Tagging of Pacific Pelagics” (TOPP) program (TOPP 2009)

Northern anchovy (*Anchoa* spp.) is the most abundant epipelagic fish of the Southern California Bight (Cross and Allen 1993). The population is centralized in the bight. The majority of fish occur inshore in the northern part of the bight during the fall. The fish move offshore and southeast with the onset of spawning in late winter. Anchovies reach reproductive maturity in 1 to 2 years and generally live 3 to 4 years. Spawning occurs below the cold, upwelled water found north of Point Conception. The southern limit of the spawning area along the Pacific Coast is determined by phytoplankton concentrations. The largest schools occur within 40 km of the coast over deep water, often over escarpments and submarine canyons (USDOI, MMS 2001). Anchovies form schools in the summer and fall months during the daytime at depths of 110 to 183 m and rise to the surface at night. In spring schools can be found at the surface during the day and disperse at night (USDOI, MMS 2001).

Some coastal epipelagic fish species do exhibit temporal changes, and the most dominant movement pattern is dispersing offshore at night from nearshore diurnal schools (Allen and Pondella 2006). Diel onshore and offshore migrations are common for certain species including adult queenfish (*Seriplus* spp.). Other nocturnal nearshore species include white seabass (*Atractoscion* spp.), Pacific electric ray (*Torpedo* spp.), gray and brown smoothhound (*Mustelus* spp.), angel shark (*Squantina* spp.), leopard shark (*Triakis* spp.), bat ray (*Myliobatis* spp.), swell shark (*Cephaloscyllium* spp.), hornshark (*Heterodontus* spp.), and black croaker (*Cheilotrema* spp.) (Allen and Pondella 2006).

Species found in the oceanic epipelagic zone of the Southern Study Area are active swimmers that are typically distributed worldwide in the temperate and tropical oceans (Allen and Cross 2006). Many of these species are permanent inhabitants of the oceanic epipelagic, although some can be found in shelf areas. Oceanic epipelagic species can be broken into two groups, those found in the top 20 to 30 m of water and those in deeper portions. Shallower species found in California waters include blackwing flyingfish (*Hirundichthys* spp.), Pacific saury (*Coloabis* spp.), blue sharks (*Prionace* spp.), basking sharks (*Cetorhinus* spp.), shortfin mako (*Isurus* spp.), ocean sunfish (*Mola* spp.), swordfish (*Xiphias* spp.), various species of tuna (Scombridae spp.), striped marlin (*Tetrapturus* spp.), and louver (*Luvarus* spp.). Species typically associated with deeper waters include opah (*Lampris* spp.), oarfish (*Regalecus* spp.), cutlassfish (*Trichiurus* spp.), ragfish (*Icosteus* spp.), longnose lancetfish (*Alepisaurus* spp.), escolar (*Gempylus* spp.), and oilfish (*Ruvettus* spp.) (Allen and Cross 2006).

7.5.2 Ichthyoplankton

Ichthyoplankton consists of the eggs and larvae of fish species found among other planktonic organisms that are unable to counter the movements of their environment. Most fish species are broadcast spawners and thus release eggs and sperm into the water column (Cross and Allen 1993). Additionally, demersal spawners that attach eggs to the substrate tend to have pelagic larvae. Once fertilized the eggs and hatched larvae are moved around by diffusion and advection of oceanic currents. Fertilized eggs are immotile, where as newly hatched larvae are capable of feeble movement and become more motile with development.

Larval mortality and recruitment success are dependent on factors such as yolk sac quality, transport, turbulence, predation, and starvation (Cross and Allen 1993). Because of the

susceptibility of young to ocean currents, the release location of eggs is an important mechanism in controlling the fate of resulting larvae. Therefore fish species have developed to either take advantage of the dispersal properties of oceanic currents or try to avoid their influence. One important component to larval dispersal is encountering areas of high productivity where larval fish can feed on phyto- and zooplankton blooms. The timing of spawning events is often associated with seasonal blooms of productivity. Larval fish, therefore, often inhabit the same parts of the water column as do other members of the water column community. This includes time spent at the surface where phytoplankton production is high. Most fish larvae found in the Southern California Bight are distributed in the upper layer of the water column, which includes the upper mixed layer and the thermocline (0-125 m) (Moser and Watson 2006). Vertical migration to maximize prey availability and minimize predation is a well documented occurrence.

One of the longest ichthyoplankton surveys on the West Coast continues to be conducted by scientists of the California Cooperative Oceanic Fisheries Investigations (CalCOFI). This survey design has an offshore emphasis due to its original historical focus on sardine ichthyoplankton, although all species are identified. Most of the data collected from this survey are from areas beyond the continental shelf and in the California Current System. Approximately 160 families of fish are represented in the entire California Current region (Moser and Watson 2006). In the CalCOFI data set, larvae of coastal pelagic fish species dominate the abundance but represent only 4 percent of the total taxa (Moser et al. 2001). Midwater species have the most taxa (38 percent) but are ranked second in abundance based on total larvae. Midwater fish are considered an important component of California Current ichthyoplankton ecology. Larvae of rocky-shore fishes contribute about one-fourth of the taxa but represent a very low percentage of total abundance. In all regions of the offshore CalCOFI survey, the most abundant species found is the northern anchovy (*Anchoa* spp.), followed by the pacific hake (*Merluccius* spp.) and the California smoothtongue (*Leuroglossus* spp.). Other top ranking species include rockfishes (*Sebastes* spp.), Panama lightfish (*Vinciguerria* spp.), northern lampfish (*Stenobranchius* spp.), Pacific sardine (*Sardinops* spp.), and jack mackerel (*Trachurus* spp.) (Moser et al. 2001).

A recurrent group analysis of CalCOFI data from (1954-1960) revealed a Southern California Complex consisting of four recurrent groupings of mainly midwater species including snubnose blacksmelt (*Bathylagus* spp.) and myctophids (lanternfish) (Moser et al. 1987). The Southern Complex consists of several California Current endemic species and of warm-water cosmopolites (Moser and Watson 2006). Spawning occurs primarily in the warmer months. During El Niño warm regimes, larval abundance of the Southern Complex is increased due to expansion of geographic distribution northward and shoreward (Moser and Watson 2006). A guide to the ichthyoplankton of the California Current region was published by Moser (1996).

The coastal assemblage of ichthyoplankton is located on the continental shelf and shoreward (less than 200 m). Over 400 species from over 100 families have been observed in the nearshore ichthyoplankton assemblage off the California coast (Moser and Watson 2006). Nearshore species must remain near the coast during larval development to maintain adult populations. This can be challenging for species with long development times that get carried offshore,

especially during periods of intense upwelling (Moser and Watson 2006). For many of the nearshore species, a shoreward transport mechanism is needed to keep recruitment rates high.

The nearshore assemblage is dominated by Pacific sardine and herrings (Engraulidae), silversides (Atherinidae), croakers (Sciaenidae), and various flatfish (Paralichthyidae and Pleuronectidae). McGowen (1993) found that white croaker (*Genyonemus* spp.), northern anchovy (*Anchoa* spp.), sanddabs (*Citharichthys* spp.), California halibut (*Paralichthys* spp.), diamond turbot (*Hypsopsetta* spp.), and hornyhead turbot (*Pleuronichthys* spp.) were abundant between the 15-m and the 36-m isobaths. For more detail regarding the ichthyoplankton assemblage of nearshore Southern California shelf areas refer to McGowen (1993).

Spawning on the Southern California Bight shelf occurs in winter-spring (cool water), in summer-fall (warm months), or more or less evenly throughout the year (Moser and Watson 2006). The pelagic spawners in the nearshore shelf system exhibit the most seasonality, while demersal species tend to spawn year-round (Moser and Watson 2006). Horizontal spatial distributions of ichthyoplankton in Southern California are primarily cross-shelf rather than alongshore. As with offshore ichthyoplankton species, during El Niño warm regimes, nearshore warm-water species are more abundant and found further north along the California coast, although species whose ranges are centered in the Southern California Bight exhibit less response to warm and cold regime shifts (Moser and Watson 2006).

Watson et al. (2002) performed an analysis of the ichthyoplankton community around the northern Channel Islands and Santa Barbara Channel. This study found the community varied seasonally. Another study that focused on the effects of the eddy within the Santa Barbara Channel found higher concentrations of larval fish during years with increased eddy activity (Nishimoto and Washburn 2002).

Pacific sardine (*Sardinops* spp.) and the northern anchovy (*Anchoa* spp.) are commonly found in the ichthyoplankton of the Southern California Bight. Both species are important forage fish and the targets of large commercial fishing industries. Historically the Pacific sardine has been heavily overfished along the California coast. Success of fishery regulations has become apparent through increased presence of individual species in the ichthyoplankton (Smith and Moser 2000). A study by Checkley et al. (2000) found that sardine eggs were primarily associated with waters directly adjacent to the California Current, while anchovy eggs were found farther inshore in the Bight. Checkley et al. (2000) hypothesize this distribution was associated with temperature and salinity of the water masses: sardines preferring the warmer water near the currents and anchovies preferring the cooler upwelled water (Checkley et al. 2000). McClatchie et al. (2008) report that the highest Pacific sardine larval abundance is found along the inner edge of the California Current at the edges of eddies. In the Southern Study Area, sardine eggs were widely distributed, and were most abundant between San Diego and Avila Beach (McClatchie et al. 2008).

Long-term data sets, such as CalCOFI, that exhibit shifts in sardine (*Sardinops* spp.) and anchovy (*Anchoa* spp.) ichthyoplankton abundance provide evidence of the interdecadal modulation of ENSO from the PDO. In general, patterns of cool “anchovy regimes” and warm

“sardine regimes” are observed in the California Current System (Chavez et al. 2003). The El Niño event occurring in 2006 was of moderate strength. Spring 2007 CalCOFI cruise data showed that Pacific sardine larval abundance was relatively high and distributed in relation to the inner edge of the California Current and the edge of an eddy. Northern anchovy larvae were relatively low in abundance (McClatchie et al. 2008).

The relationship between the daily egg production and the average sea surface temperature (°C) during 1994 through 2005 indicated that in most years, except in 1997 and 2002, an increase of daily egg production coincided with an increase of sea surface temperature. This relationship is consistent with the assertion that high temperature is favorable for the Pacific sardine (Jacobson and MacCall 1995), in particular in recent years.

Bay and estuarine ichthyoplankton assemblages found in the Southern Study Area are typically smaller than assemblages found in northern Pacific or Atlantic estuaries. Ichthyoplankton assemblages in these embayments typically consist of resident species with limited contributions from open coastal species (Moser and Watson 2006). Ichthyoplankton found in bays and estuaries include gobies (Gobiidae), several species of anchovies (Engraulidae), silversides (Atherinidae), and blennies (Blenniidae). Fish larvae in embayments are dominated by demersally spawning species. It is thought that demersal species may be better able to resist transport out of the embayment environment because they remain near the sediments where outward transport is slower or bottom water flows into the estuary (Moser and Watson 2006).

7.5.3 Neuston

The sea surface environment provides an important habitat for many organisms commonly referred to as neuston. Neustonic organisms are those that spend either part or all of their life cycles in the top layer of the water column. In addition to several types of invertebrates, fish eggs and larvae have been found to make up significant portions of neustonic communities (Grant 1986). Fish eggs are commonly part of this community, as they are often positively buoyant. There have been numerous larval fish observed in the surface layer, many of which are commercially and recreationally important, such as billfish, dolphinfish, and tunas (Hempel and Weikert 1972). Larvae of most species are not consistently members of this community as they migrate vertically over the course of the day to maximize prey abundance and minimize predation. Larval fish of some species appear to actively seek the surface layer by adjusting their swim bladders to become buoyant (e.g., sardines, Santos et al. 2006). Certain species of fish are noted as having larval stages that are completely neustonic or surface dwelling (e.g. gurnards, (dactylopteridae)) (Cowen 2002). The most common larval fish occurring in the Southern California Bight neustonic layer by day are members of the family Exocoetidae (flying fish) as well as sauries (Scomberesocidae) and grunion (Atherinopsidae) (Gruber et al. 1982). The effects of sea surface warming due to climate change on neustonic assemblages, especially fish larvae, are not well understood. Vilchis et al. (2009) found from a study of eastern Pacific neustonic larval fish species performed over a 13-year period that assemblages in oligotrophic waters are more resilient to changes in the thermocline than are those found in regions of upwelling.

7.5.4 Mesopelagic and Bathypelagic

The mesopelagic or midwater zone is from 200 to 1,000 m in depth and located over the shelf slope and deep basins. The bathypelagic zone includes areas deeper than 1,000 m. Midwater trawling, oblique tows, and data from submersible expeditions are the main methods of fish collection from these areas. Due to complexity of data collection, less is known about the fish in the mesopelagic and bathypelagic zones. Fish species in these zones have large eyes, jaws and teeth, and feed on deepwater invertebrates. Meso- and bathypelagic species spawn at depth and their eggs and larvae rise toward the surface. Larvae of deepwater species utilize the zooplankton resources of the euphotic zone. Juvenile and young fish then migrate back down to deeper waters.

In Southern California waters, there are approximately 120 species of deepwater fishes, with only a few being of commercial importance (Cross and Allen 1993). Fish species found in the shallower portions of the mesopelagic zone are silvery and may exhibit vertical migration to the thermocline at night (Neighbors and Wilson, Jr. 2006). Fish in the deeper mesopelagic are mostly nonreflective, pinkish, or translucent. Bathypelagic fish are generally black or red in coloration. The meso- and bathypelagic zones are cold, dark, sparsely populated regions. The only light present is created by bioluminescent organisms. Typical species of these zones include eel-like fish (Zoarcidae), deep-sea smelts (Argentinidae), barracudina (Paralepididae), tubeshoulder (Platytroutidae), bristlemouths (Gonostomatidae), hatchetfish (Sternoptychidae), lanternfish (Myctophidae), blackchin (Neoscopelidae), bigscales (Melamphaidae), fangtooth (Anoplogastridae), and dreamers (Oneirodidae).

7.6 FISHES OF SOFT SUBSTRATES

Soft substrate is the most abundant benthic habitat type found in the Southern Study Area. Areas consisting of soft substrate include bays and estuaries, surf zones, and the continental shelf and slope. “Soft substrate,” or “soft sediment,” refers to unconsolidated sediments ranging from fine silts and clays to coarse, well sorted sands. Each of these soft sediment habitats supports a unique assemblage of pelagic, demersal, and benthic fish species.

In the bays and estuaries of Southern California, bottom sediments range from fine silty clay to sands. Typically estuaries are difficult environments to inhabit due to varying conditions such as dissolved oxygen and salinity. However, estuaries also tend to be nutrient rich and have high levels of primary productivity (Allen et al. 2006). Resident fish species are usually hearty and capable of surviving a wide range of environmental circumstances. Embayments are used by fish as spawning sites, as nursery habitat, and for migration. Several species of forage fish exist in these environments and serve as prey for many commercially valuable species.

Southern California bays and estuaries are small and mainly marine in character, as they are fed by small seasonal rivers and streams (Allen et al. 2006). Bays and estuaries found in the Southern Study Area include Carpinteria Marsh, Mugu Lagoon, Malibu Lagoon, Alamitos Bay, Anaheim Bay, Newport Bay, Los Penasquitos Lagoon, Mission Bay, San Diego Bay, and Tijuana Estuary. The fish assemblages found in these systems are unique, in that there is a lack of a large freshwater component except during occasional winter floods (Allen et al. 2006). Also there is a general lack of anadromous fish species. The Pacific lamprey (*Lampertra* spp.) and the

Southern California ESU steelhead (*Oncorhynchus* spp.) are among the only anadromous species present. The presence of the only catadromous fish, the striped mullet (*Mugil* spp.), also gives these assemblages further distinction (Allen et al. 2006). Eelgrass beds provide important habitat for species such as bay and barred pipefish (*Syngnathus* spp.), shiner perch (*Cymatogaster* spp.), and giant kelpfish (*Heterostichus* spp.) (Allen et al. 2002). Salt marsh channels are home to estuarine species such as the California killifish (*Fundulus* spp.) and longjaw mudsucker (*Gillichthys* spp.), whereas shallow mudflats are inhabited by several species of gobies including arrow, shadow, and cheekspot (Gobiidae spp.). Topsmelt (*Atherinopsis* spp.), striped mullet (*Mugil* spp.), deepbody anchovy (*Anchoa* spp.), and slough anchovy (*Anchoa* spp.) can be found in the water column along the shoreline and in channels. The deeper channels and benthic habitats are populated by common marine migrants and estuarine residents such as black perch (*Embiotoca* spp.), spotted sand bass (*Paralabrax* spp.), diamond turbot (*Hypsopsetta* spp.), juvenile California halibut (*Paralichthys* spp.), round stingray (*Urolophus* spp.), and barred sand bass (*Paralabrax* spp.) (Allen et al. 2002).

Nearshore shallow surf zones offer soft sediment habitats to a variety of fish. This environment is constantly moving and changing due to wave, tide, and shoreline processes. The surf zone is turbulent and receives a high level of nutrient and detrital input, and supports large populations of small invertebrates ([see chapter 6](#)). Even though energy expenditure is high in surf zones, several species of fish are attracted to it for foraging purposes (Allen and Pondella 2006). Exposed beaches are occupied by the following types of feeders: small active planktivores, roving substratum feeders, and piscivores. The most numerically dominant species found in the Southern California surf zone include the northern anchovy (*Anchoa* spp.), silversides (jacksmelt and topsmelt, *Atherinopsis* spp.), juvenile queenfish (*Seriphus* spp.), and walleye surfperch (*Hyperprosopon* spp.). Other species present include the California grunion (*Leuresthes* spp.), dwarf perch (*Micrometrus* spp.), deepbody anchovy (*Anchoa* spp.), barred surfperch (*Amphistichus* spp.), spotfin croaker (*Roncador* spp.), California corbina (*Menticirrhus* spp.), yellowfin croaker (*Umbrina* spp.), round stingray (*Urolophus* spp.), leopard shark (*Triakis* spp.), and gray smoothhound (*Mustelus* spp.). Benthic drift algae found adjacent to the surf zone provide an important habitat component for certain fish species. Species associated with drift algae are the giant kelpfish (*Heterostichus* spp.), the spotted kelpfish (*Gibbonsia* spp.), and the kelp and barcheck pipefish (*Syngnathus* spp.) (Allen and Pondella 2006).

The continental shelf gradually slopes seaward to the steep continental slope. Typically the shelf is defined as seaward areas to the 200 m isobath. Areas beyond the 200 m isobath are considered slope. The mainland shelf along the Southern California coast is narrow (0.06-13 km) compared to northern shelf regions (less than 1-50 km) (Allen 2006). Shelf areas also occur around the coastal islands of Southern California. Soft sediments dominate the benthic habitat of the continental shelf and upper slope. Sandy sediments are more common in nearshore areas of the shelf, while silt and clays can be found out toward the slope. These expanses of soft sediment are typically low relief, with occasional rocky outcroppings, or biogenic reef structures. The shelf assemblage (approximately 5 to 200 m deep) can be broken up into three regions: inner, middle, and outer. Deepwater outer shelf and slope fish species are adapted to low temperatures, low dissolved oxygen, low light, and high pressure conditions. Certain fish families have body

morphologies adapted to living in soft-bottom habitats including Pleuronectiformes (flatfish), Rajiformes (rays), and Ophidiidae (cusk-eels).

The inner continental shelf stretches from 5 to 30 m deep. Of all the shelf regions, the inner shelf bottom habitat is subjected to the most environmental variability (turbulence, temperature, salinity, light penetration, suspended sediments, etc.). The inner shelf assemblage is composed of demersal species such as queenfish (*Seriphus* spp.), white croaker (*Genyonemus* spp.), shiner perch (*Cymatogaster* spp.), white seaperch (*Phanerodon* spp.), and barred sand bass (*Paralabrax* spp.). Soft sediment benthic species include California lizardfish (*Synodus* spp.), specklefin midshipman (*Porichthys* spp.), basketweave cusk-eel (*Ophidian* spp.), thornback (*Platyrrhinoidis* spp.), California skate (*Raja* spp.), California tonguefish (*Symphurus* spp.), diamond turbot (*Hypsopsetta* spp.), fantail sole (*Xystreureys* spp.), English sole (*Parophrys* spp.), California halibut (*Paralichthys* spp.), hornyhead turbot (*Pleuronichthys* spp.), and speckled sanddab (*Citharichthys* spp.) (Allen 2006).

The middle shelf (30-100 m) is usually the widest part of the shelf. Benthic habitats in this region are typically below the thermocline and subjected to less seasonal and environmental variability, although seasonal changes occurring in the epipelagic zone above the middle shelf can have affects on the benthic habitat. The demersal and benthic species assemblage includes California lizardfish (*Synodus* spp.), shiner perch (*Cymatogaster* spp.), Pacific argentine (*Argentina* spp.), pygmy poacher (*Odontopyxis* spp.), California tonguefish (*Symphurus* spp.), yellowchin sculpin (*Icelinus* spp.), roughback sculpin (*Chitonotus* spp.), spotted scorpionfish (*Scorpaena* spp.), longfin sanddab (*Citharichthys* spp.), California skate (*Raja* spp.), hornyhead turbot (*Pleuronichthys* spp.), and bigmouth sole (*Hippoglossina* spp.) (Allen 2006; Allen et al. 2007).

The outer shelf (100-200 m) typically has a steeper incline than the other two shelf regions. Certain areas of the outer shelf stretch beyond the shelf break. Demersal and benthic fish assemblage in the Southern California outer shelf is composed of white croaker (*Genyonemus* spp.), shortbelly rockfish (*Sebastes* spp.), Pacific argentine (*Argentina* spp.), pink seaperch (*Zalemibus* spp.), stripetail rockfish (*Sebastes* spp.), spotted ratfish (*Hydrolagus* spp.), sablefish (*Anoplopoma* spp.), California lizardfish (*Synodus* spp.), greenspotted rockfish (*Sebastes* spp.), shortspine combfish (*Zaniolepis* spp.), smooth stargazer (*Kathetostoma* spp.), hundred fathom codling (*Physiculus* spp.), blacktip poacher (*Xeneretmus* spp.), plainfin midshipman (*Porichthys* spp.), spotted cusk-eel (*Chilara* spp.), longnose skate (*Raja* spp.), bearded eelpout (*Lyconerna* spp.), bigmouth sole (*Hippoglossina* spp.), gulf sanddab (*Citharichthys* spp.), rex sole (*Glyptocephalus* spp.), slender sole (*Lyopsetta* spp.), and Dover sole (*Microstomus* spp.) (Allen 2006).

The upper slope (200-500 m) has a sharp incline and is composed mainly of fine silts. The Southern California upper slope is mostly narrow along the mainland, but it extends out from Point Conception and around the Channel Islands to the Cortez Bank, forming a wide peninsula. Species assemblage and distribution are not well defined due to lack of data from these deeper habitats. Families and species of fish that compose the demersal and benthic assemblage include Merlucciidae (Pacific hake), Rajidae (longnose skate), Scorpaenidae (splitnose rockfish and shortspine thornyhead), Pleuronectidae (slender sole, rex sole, and Dover sole), Ophidiidae

(spotted cusk-eel), Chimaeridae (spotted ratfish), Scyliorhinidae (brown cat shark), Macrouridae (California grenadier), Anoplomatidae (sablefish), Liparidae (blacktail snailfish), and Zoaracidae (bigfin eelpout) (Allen 2006). Allen et al. (2007) found this community to be defined by the presence of splitnose rockfish and Pacific hake, and associated with rex sole.

7.7 FISHES OF HARD SUBSTRATES AND KELP BEDS

7.7.1 Rocky Intertidal

The rocky intertidal zone is a wave-swept, unstable, and turbulent environment to inhabit, although the rocky intertidal areas of the Southern Study Area are highly productive and rich in macrophytes and invertebrates. Fish species living in these habitats, especially tide pools, must be capable of enduring extreme physical and chemical conditions (Davis 2000). Intertidal fish protect themselves from surge and wave action by inhabiting holes, rock crevices, or algae (Cross and Allen 1993). These areas are subjected to daily fluctuations of water level, temperature, and salinity. As a result of these varying conditions, a unique assemblage of fish species exists in Southern California rocky intertidal areas. Common resident and transient species of Southern California rocky intertidal zones include sculpins (wooly, bald, and rosy (*Clinocottus* spp.)), opaleye (*Girella* spp.), California clingfish (*Gobiesox* spp.), rockpool blenny (*Hypsoblennius* spp.), striped and spotted kelpfish (*Gibbonsia* spp.), and reef finspot (*Paraclinus* spp.) (Horn and Martin 2006).

Some species are found in both intertidal and subtidal zones, but most are specific to the intertidal region. The rocky intertidal assemblage does exhibit some seasonality in the Southern Study Area. Abundance in the winter months tends to decline, perhaps due to more mobile species migrating to deeper waters (Horn and Martin 2006). Conversely in the summer species richness and abundance, especially of juveniles, are increased. Resident species of the rocky intertidal are mainly demersal spawners that attach their eggs to the substrate, or macrophytes. Larvae are pelagic but only disperse a short distance from the shore and tend to stay localized within the area in which they were hatched. Rocky intertidal species are relatively short-lived (2 to 6 years). Fish are either carnivores or omnivores, but a majority feed on the benthic invertebrates such as copepods, amphipods, and decapods. Vertical zonation of fish species in the rocky intertidal zone is common. Physical factors such as tidal height, type of cover, wave exposure, and substratum influence zonation (Horn and Martin 2006).

Rocky intertidal habitats in the Southern Study Area are separated by large stretches of sandy beach and other habitat. Because intertidal fish exhibit limited dispersal, northward range expansion in response to climate change and ocean warming may not be an option (Horn and Martin 2006). Davis (2000) investigated the rocky intertidal fish assemblages near San Diego and their responses to the El Niño 1996-2000 conditions. The wooly sculpin, typically a colder temperate species, decreased in abundance during the El Niño due to lack of recruitment, but increased again during the La Niña that immediately followed (Davis 2000). Conversely the reef fin spot, a tropical warm species, showed the opposite pattern in abundance (Davis 2000).

7.7.2 Rocky Reefs and Kelp Beds

Benthic areas with vertical relief, such as kelp beds with gradients oriented more vertically than horizontally, attract several species of fish. The habitat may reach from the sea floor to the sea surface. Fishes of both pelagic and benthic habitats are associated with these areas (USDOI, MMS 2007). The assemblage of fish found in these shallow subtidal rocky reefs exhibit the highest richness and diversity of all the habitat types found in Southern California (Stephens et al. 2006). Recent estimates suggest that this habitat supports between 6 and 15 times the density of fishes of a similar area of soft substrate (Bond et al. 1999). For this reason several marine sanctuaries and reserves have been established protecting these habitats.

The kelp forests of the Southern Study Area are some of the most heavily studied habitats in U.S. waters. Factors that affect fish assemblage include depth, temperature, bottom type, vertical relief, and vegetative cover. Regional temperature regime shifts, such as El Niño and the PDO, can affect productivity and are critical factors in understanding the population dynamics of kelp forest assemblages (Stephens et al. 2006). Graves et al. (2006) observed changes in the fish assemblages inhabiting rocky reef habitat off Santa Cruz Island. Between the 1970s and 1996 changes were consistent with ocean warming trends, where southern species increased in abundance (Graves et al. 2006). Analysis of data collected from 2004-05 potentially suggested an assemblage shift back toward colder, more northerly-distributed species (Graves et al. 2006).

Spawning and larval recruitment in kelp forests are not well understood. Passive drift, active swimming of late stage larvae or early stage juveniles, or larval retention around reef habitat may be species specific and play significant roles in the recruitment process (Stephens et al. 2006).

More than 150 species of fish can be found in and near kelp forests. Taxa contributing the greatest biomass, numerical abundance, or species richness to the rock-reef and kelp-forest community are Acanthopterygians (spiny-finned fish) including Serranidae, Pomacentridae, Labridae, Kyphosidae, Embiotocidae, Scorpaenidae (especially *Sebastes* spp.), Hexagrammidae, Gobiidae, and Cottidae (Hobson 1994). The reef fish assemblage of the Southern Study Area consists of three elements because of its geographic location (Stephens et al. 2006). One element consists of species from families that are primarily tropical and subtropical and do not exist north of Point Conception, including chubs (Kyphosidae), grunts (Haemulidae), croakers (Sciaenidae), damselfish (Pomacentridae), wrasses (Labridae), gobies (Gobiidae), blennies (Blenniidae), and basses (Serranidae). A second element consists of colder-water species that dominate kelp forests north of Point Conception and may occur in some areas of Southern California (Stephens et al. 2006). These colder-water species include rockfishes (*Sebastes* spp.), surfperches (Embiotocidae), greenlings (Hexagrammidae), and sculpins (Cottidae). The third element consists of species which are generally derived from cool-temperate taxa, but have distributions centered in the San Diegan province (Stephens et al. 2006). These species include kelp rockfish and black perch.

Transient, pelagic species from the Clupeidae, Engraulidae, Scombridae, Carangidae, and Sciaenidae families may play a significant role in the energetics of reef and kelp communities (Stephens et al. 2006). The common species found in Southern California assemblage include blacksmith (*Chromis* spp.), halfmoon (*Medialuna* spp.), salema (*Xenistius* spp.), garibaldi

(*Hypsypops* spp.), kelp bass (*Paralabrax* spp.), black perch (*Embiotoca* spp.), California sheephead (*Semicossyphus* spp.), treefish (*Sebastes* spp.), rock wrasse (*Halichoeres* spp.), ocean whitefish (*Caulolatilus* spp.), giant sea bass (*Stereolepis* spp.), zebraperch (*Hermosilla* spp.), barred sand bass (*Paralabrax* spp.), and opaleye (*Girella* spp.).

7.7.3 Deep Reefs

Deep reef habitats are typically found from 30 to 500 m deep. This depth range includes areas of the continental shelf as well as portions of the continental slope. The reefs are areas of complex, often high-relief, substrates including rocky outcroppings, cobble, and boulders. High epifaunal invertebrate coverage and biogenic reef occur on these substrates. Due to the remoteness of these habitats, less is known about the associated fish assemblages. Two deep-reef areas located in the Southern California Bight are Tanner and Cortes Banks. Fish species that exist in these habitats are associated with high structural complexity. Deep reef habitats are relatively stable and show low seasonal variability. Fishes living in deep reefs can be placed into three categories: midwater aggregators (i.e., schooling), demersal aggregators, and demersal nonaggregators or solitary individuals (Love and Yoklavich 2006). Deep reef habitats of Southern California are dominated by members of the rockfish family (Scorpaenidae). Species include shortbelly rockfish, bocaccio, bank rockfish, chilipepper rockfish, greenstripe rockfish, greenspotted rockfish, rosethorn rockfish, pinkrose rockfish, greenblotched rockfish, and cowcod.

7.8 TROPHIC INTERACTIONS

Trophic interactions are the feeding relationships between different levels of the food web. Understanding relationships between these levels is very important and influential in ecological assessments and fisheries management. Top-down and bottom-up food web interactions have become an important field of study as ecosystem-based management of fishery resources is implemented. Trophic interactions have been defined for fish in seven different habitat types of Southern California: bay and estuary, inner shelf, outer shelf, rocky intertidal, rocky subtidal kelp bed, epipelagic, and midwater species (Horn and Ferry-Graham 2006).

The bay and estuarine fish assemblages consist of small to medium herbivores, detritivores, and planktivores (i.e., topsmelt) which are directly fed upon by tertiary carnivores such as spotted sand bass. Small primary carnivores (i.e., gobies) that forage primarily on benthic macroinvertebrates and zooplankton serve as forage for medium-sized secondary carnivores such as yellowfin croaker. Tertiary carnivores feed mostly on secondary carnivores and medium-sized herbivores and detritivores (Horn and Ferry-Graham 2006).

The rocky intertidal assemblage consists of several species of herbivores and omnivores such as pricklebacks and reef perch, which feed on macroalgae. Primary carnivores are composed of small-bodied fish such as sculpin and clingfish, which feed on macrobenthic invertebrates. Secondary and tertiary carnivores, medium to large in size, include kelpfish and rockfish (Horn and Ferry-Graham 2006).

Small primary carnivores such as the northern anchovy are near the base of the food web of the inner shelf assemblage and fed upon by secondary carnivores (e.g. walleye surfperch). Large-

bodied tertiary carnivores like the barred sand bass feed primarily on most secondary carnivores. Similar trophic relationships are observed in the outer shelf assemblage, with the northern anchovy representing the primary carnivore group and main food item of secondary carnivores (i.e. striptail rockfish). Tertiary carnivores include larger-bodied fish such as California lizardfish and California scorpionfish (Horn and Ferry-Graham 2006).

In the epipelagic zone, primary carnivores feeding on zooplankton include the Pacific sardine and the smallhead flyingfish. Medium- to larger-bodied secondary and tertiary carnivores include mackerals, bonitos, tuna, and swordfish. In the pelagic zone the main quarternary carnivore representative is the shortfin mako shark. The deeper midwater fish assemblage is composed of smaller primary carnivores, such as lanternfish and hatchetfish, which feed on chaetognaths, natant decapods, and larval fishes. Secondary and tertiary carnivores include fish such as lampfish and dragonfish (Horn and Ferry-Graham 2006).

7.9 SUMMARY AND DATA GAPS

Further understanding of existing distributional patterns and fish biogeography in the Southern Study Area and regions to the north is needed. Assessment of effects of climate change on fish distributions will be dependent on quality of long-term data sets, species range data, ecosystem response information, and trends in short-term climatic regime shifts (Horn et al. 2006). Continued long-term, standardized, fisheries-independent quantitative studies should be undertaken, examining populations of groundfish and pelagic fish stocks. These long-term data sets, which include quantitative measures of assemblages of species, as opposed to single stocks, lead to further understanding of the ecosystem dynamics of the shelf and pelagic environments. Also large-scale fluctuations and their relationship to climatic regime shifts and change can be better examined. Additionally these types of surveys ultimately lead to better understanding and management of exploited species. Remote sensing of sea surface temperature and nutrients will also inform studies regarding population fluctuations and shifts (Allen and Cross 2006).

Comparative studies of rocky intertidal fishes and their subtidal relatives is an important future research topic. Resident species of the rocky intertidal zone in the Southern Study Area are vulnerable to the effects of climate change due to their low dispersal and localization around specific regions. They are also vulnerable to oil spills ([see Section 7.7.1](#)). It is important to understand how residents of the rocky intertidal differ and what adaptations have been developed to enable them to live in such a demanding environment (Horn and Martin 2006).

The effects of climate change on kelp forest species composition is an important field of research. As sea surface temperatures increase, and various species ranges are either limited or extended, how are kelp forest communities affected or altered? Another important question is how the loss of kelp habitat affects various associated fish species?

Trophic cascades, as well as top-down and bottom-up effects in the food web, are important research topics in addressing how fishery exploitation, climate change, and coastal and offshore development can impact the ecosystems found in the Southern Study Area (Pinnegar et al. 2000).

7.10 LIST OF LITERATURE CITED—FISH

- Adams, P.B., C.B. Grimes, J.E. Hightower, S.T. Lindley, and M.L. Moser. 2002. Status review for the North American green sturgeon. NOAA, National Marine Fisheries Service, Southwest Fisheries Science Center, Santa Cruz, CA. 49 pp.
- Allen, L.G. 2006. Chapter seven: Continental shelf and upper slope. In: Allen, L.G., D.J. Pondella, and M.H. Horn, eds. Ecology of marine fishes: California and adjacent waters. Berkeley, CA: University of California Press. Pp. 167-202.
- Allen, L.G. and J.N. Cross. 2006. Chapter twelve: Surface waters. In: Allen, L.G., D.J. Pondella, and M.H. Horn, eds. Ecology of marine fishes: California and adjacent waters. Berkeley, CA: University of California Press. Pp. 320-341.
- Allen, L.G., A.M. Findlay, and C.M. Phalen. 2002. Structure and standing stock of the fish assemblage of San Diego Bay, California from 1994 to 1999. Bulletin of Southern California Academic Science 101:49-85.
- Allen, L.G. and D.J. Pondella. 2006. Chapter six: Surf zone, coastal pelagic zone, and harbors. In: Allen, L.G., D.J. Pondella, and M.H. Horn, eds. Ecology of marine fishes: California and adjacent waters. Berkeley, CA: University of California Press. Pp. 149-166.
- Allen, L.G., M.M. Yoklavich, G.M. Cailliet and M.H. Horn. 2006. Chapter five: Bays and estuaries. In: Allen, L.G., D.J. Pondella, and M.H. Horn, eds. Ecology of marine fishes: California and adjacent waters. Berkeley, CA: University of California Press. Pp. 119-148.
- Allen, M.J., T. Mikel, D. Cadien, J.E. Kalman, E.T. Jarvis, K.C. Schiff, D.W. Diehl, S.L. Moore, S. Walther, G. Deets, C. Cash, S. Watts, D.J. Pondella, II, V. Raco-Rands, C. Thomas, R. Gartman, L. Sabin, W. Power, A.K. Groce, and J.L. Armstrong. 2007. Southern California Bight 2003 Regional Monitoring Program: IV. Demersal fishes and megabenthic invertebrates. Southern California Coastal Water Research Project. Costa Mesa, CA.
- Behnke, R.J. 1992. Native trout of western North America (AFS Monograph 6). Bethesda, MD: American Fisheries Society.
- Bellman, M.A. and S.A. Heppell. 2007. Trawl effort distribution off the U.S. Pacific Coast: Regulatory shifts and seafloor habitat conservation. In: Heifetz, J., J. Dicosimo, A.J. Gharrett, M.S. Love, V.M. O'Connell, and R.D. Stanley, eds. Biology, assessment, and management of North Pacific rockfishes. Alaska Sea Grant, University of Alaska Fairbanks. Pp. 275-294.
- Bennett, W.A., K. Roinestad, L. Rogers-Bennett, L. Kaufman, D. Wilson-Vandenberg and B. Heneman. 2004. Inverse regional responses to climate change and fishing intensity by the recreational rockfish (*Sebastes* spp.) fishery in California. Canadian Journal of Fisheries and Aquatic Sciences 61(12):2499-2511.

- Bograd, S.J., P.M. DiGiacomo, R. Durazo, T.L. Hayward, K.D. Hyrenbach, R.J. Lynn, A.W. Mantyla, F.B. Schwing, W.J. Sydeman, T. Baumgartner, B. Lavaniegos and C.S. Moore. 2000. The state of the California Current, 1999-2000: Forward to a new regime? California Cooperative Oceanic Fisheries Investigations (CalCOFI) Reports Vol. 41. Pp. 26-52.
- Bond, A.B., J.S. Stephens, Jr., D.J. Pondella, M.J. Allen and M. Helvey. 1999. A method for estimating marine habitat values based on fish guilds, with comparisons between sites in the Southern California Bight. *Bulletin of Marine Science* 64(2):219–242.
- Chavez, F.P., J. Ryan, S.E. Lluch-Cota and M. Niquen. 2003. From anchovies to sardines and back: Multidecadal change in the Pacific Ocean. *Science* 299(5604):217-221.
- Checkley Jr., D.M., R.C. Dotson and D.A. Griffith. 2000. Continuous, underway sampling of eggs of Pacific sardine (*Sardinops sagax*) and northern anchovy (*Engraulis mordax*) in spring 1997 and 1997 off southern and central California. *Deep-Sea Research II* 47:1139-1155.
- Cowen, R.K. 2002. Chapter 7: Oceanographic influences on larval dispersal and retention and their consequences for population connectivity. In: Sale, P.F., ed.. *Coral reef fishes, Dynamics and diversity in a complex ecosystem*. San Diego, CA: Academic Press. Pp. 149-169.
- Cross, J.N. and L.G. Allen. 1993. Fishes. In: Dailey, M.D., D.J. Reish, and J.W. Anderson, eds. *Ecology of the Southern California Bight: A synthesis and interpretation*. Berkeley, CA: University of California Press. Pp. 369-458.
- Davis, J.L.D. 2000. Changes in a tidepool fish assemblage on two scales of environmental variation: Seasonal El Niño southern oscillation. *Limnology and Oceanography* 45:1368-1379.
- Dawson, M.N., J.L. Staton and D.K. Jacobs. 2001. Phylogeography of the tidewater goby, *Eucyclogobius newberryi* (Teleostei, Gobiidae), in coastal California. *Evolution* 55:1167-1179.
- DeMartini, E.E. and P.C. Sikkel. 2006. Chapter nineteen: Reproduction. In: Allen, L.G., D.J. Pondella, and M.H. Horn, eds. *Ecology of marine fishes: California and adjacent waters*. Berkeley, CA: University of California Press. Pp. 483-523.
- Dotson, R.C. and R.L. Charter. 2003. Trends in the Southern California sport fishery. California Cooperative Oceanic Fisheries Investigations (CalCOFI) Reports Vol. 44. Pp. 94-106.
- Grant, G.C. 1986. *Zooneuston: Animals of the sea surface*. In: Proceedings of the Workshop on the Sea-Surface Microlayer in Relation to Ocean Disposal. December 18-19, 1985, Airlie, Virginia. EPA Report 556/1-87/005. Pp. 45-62.
- Graves, M.R., R.J. Larson and W.S. Alevizon. 2006. Temporal variation in fish communities off Santa Cruz Island, California. California Sea Grant College Program.

- Gruber, D., E.H. Ahlstrom and M.M. Mullin. 1982. Distribution of *ichthyoplankton* in the Southern California Bight. California Cooperative Oceanic Fisheries Investigations (CalCOFI) Reports Vol. 23. Pp. 172-179.
- Halpern, B.S., K. Cottenie and B.R. Broitman. 2006. Strong top-down control in Southern California kelp forest ecosystems. *Science* 312:1230-1232.
- Hempel, G. and H. Weikert. 1972. The neuston of the subtropical and boreal North-eastern Atlantic Ocean. A review. *Marine Biology* 13:70-88.
- Hill, K., D. Aseltine-Neilson, M. Dege, M. Erickson, P. Haaker, K. Karpov, K. Oda, D. Ono, S. Owen, C. Pattison, I. Taniguchi, D. Thomas, J. Ugoretz, R. Warner, D. Wilson-Vandenberg and M. Yaremko. 1999. Review of some California fisheries for 1998: Pacific sardine, Pacific herring, market squid, sea urchin, groundfishes, swordfish, sharks, nearshore finfishes, abalone, Dungeness crab, prawn, ocean salmon, hite Seabass, and recreational. California Cooperative Oceanic Fisheries Investigations (CalCOFI) Reports Vol. 40. Pp. 9-24.
- Hobson, E.S. 1994. Ecological relations in the evolution of acanthopterygian fishes in warm temperate communities of the northeastern Pacific. *Environmental Biology of Fishes* 40:49-90.
- Holts, D.B., A. Julian, O. Soso-Nishizaki and N.W. Bartoo. 1998. Pelagic shark fisheries along the West Coast of the United States and Baja California, Mexico. *Fisheries Research* 39:115-125.
- Horn, M.H., L.G. Allen and R.N. Lea. 2006. Chapter one: Biogeography. In: Allen, L.G., D.J. Pondella, and M.H. Horn, eds. *Ecology of marine fishes: California and adjacent waters*. Berkeley, CA: University of California Press. Pp. 3-25.
- Horn, M.H. and L.A. Ferry-Graham. 2006. Chapter fourteen: Feeding mechanisms and trophic interactions. In: Allen, L.G., D.J. Pondella, and M.H. Horn, eds. *Ecology of marine fishes: California and adjacent waters*. Berkeley, CA: University of California Press. Pp. 387-410.
- Horn, M.H. and K.L.M. Martin. 2006. Chapter eight: Rocky intertidal zone. In: Allen, L.G., D.J. Pondella, and M.H. Horn, eds. *Ecology of marine fishes: California and adjacent waters*. Berkeley, CA: University of California Press. Pp. 205-226.
- Jacobson, L.D. and A.D. MacCall. 1995. Stock–recruitment models for California sardine (*Sardinops sagax*). *Canadian Journal of Fisheries Aquatic Science* 52:566-577.
- Jennings, S., S. Freeman, R. Parker, D.E. Duplisea and T.A. Dinmore. 2005. Ecosystem consequences of bottom fishing disturbance. *American Fisheries Symposium* 41:73-90.
- Lafferty, K., C. Swift and R.F. Ambrose. 1999. Extirpation and recovery of local populations of the endangered tidewater goby, *Eucyclogobius newberryi*. *Conservation Biology* 13:1447-1453.

- Lea, R.N. and R.H. Rosenblatt. 2000. Observations on fishes associated with the 1997-98 El Niño off California. California Cooperative Oceanic Fisheries Investigations (CalCOFI) Reports. Vol. 41. Pp. 117-129.
- Lehodey, P., J. Alheit, M. Barange, T. Baumgartner, G. Beaugrand, K. Drinkwater, J.M. Fromentin, S.R. Hare, G. Ottersen, R.I. Perry, C. Roy, C.D. Van der Lingen and F. Werner. 2006. Climate variability, fish, and fisheries. *Journal of Climate* 19(20): 5009-5030.
- Love, M.S., J.S. Stephens, Jr., P.A. Morris, M.M. Singer, M. Sandhu and T.C. Sciarrotta. 1986. Inshore soft substrata fishes in the Southern California Bight: An overview. California Cooperative Oceanic Fisheries Investigations Reports. 27:84-106.
- Love, M.S., W. Westphal and R.A. Collins. 1985. Distributional patterns of fishes captured aboard commercial passenger fishing vessels along the northern Channel Islands, California. *United States National Marine Fisheries Bulletin* 83:243-251.
- Love, M.S. and M.M. Yoklavich. 2006. Chapter ten: Deep rock habitats. In: Allen, L.G., D.J. Pondella, and M.H. Horn, eds. *Ecology of Marine Fishes: California and Adjacent Waters*. Berkeley, CA: University of California Press. Pp. 253-266.
- Lynn, R., and S. Bograd. 2002. Dynamic evolution of the 1997-1999 El Niño-La Niña cycle in the Southern California Current System. *Progress in Oceanography* 54(1-4):59-75.
- Lynn, R.J. 2003. Variability in the spawning habitat of Pacific sardine off southern and central California. *Fisheries Oceanography* 12(6):541-553.
- Mann, K.H. and J.R.N. Lazier. 1996. *Dynamics of marine ecosystems, biological-physical interactions in the oceans: Second edition*. Malden, MA: Blackwell Science. 394 pp.
- McClatchie, S., R. Goericke, J.A. Koslow, F.B. Schwing, S.J. Bograd, R. Charter, W. Watson, N. Lo, K. Hill, J. Gottschalck, M. L'Heureux, Y. Xue, W.T. Peterson, R. Emmett, C. Collins, G. Gaxiola-Castro, R. Durazo, M. Kahru, B.G. Mitchell, K.D. Hyrenbach, W.J. Sydeman, R.W. Bradley, P. Warzybok and E. Bjorkstedt. 2008. The state of the California current, 2007-2008: La Nina conditions and their effects on the ecosystem. California Cooperative Oceanic Fisheries Investigations (CalCOFI) Reports Vol. 49. Pp. 39-76.
- McGowen, G.E. 1993. Coastal ichthyoplankton assemblages, with emphasis on the Southern California Bight. *Bulletin of Marine Science* 53(2):692-722.
- McKeown, B.A. 1984. *Fish migration*. Portland, OR: Timber Press. 224 pp.
- Moser, H.G., ed. 1996. The early stages of fishes in the California Current region. California Cooperative Oceanic Fisheries Investigations CalCOFI Atlas 33.
- Moser, H.G., R.L. Charter, W. Watson, D.A. Ambrose, K.T. Hill, P.E. Smith, J.L. Butler, E.M. Sandknop and S.R. Charter. 2001. The CalCOFI ichthyoplankton time series: Potential

- contributions to the management of rocky-shore fishes. California Cooperative Oceanic Fisheries Investigations (CalCOFI) Reports Vol. 42. Pp. 112-128.
- Moser, H.G., P.E. Smith and L.E. Eber. 1987. Larval fish assemblage in the California current region, 1954-1960, a period of dynamic environmental change. California Cooperative Oceanic Fisheries Investigations (CalCOFI) Reports Vol. 28. Pp. 97-127.
- Moser, H.G. and W. Watson. 2006. Chapter eleven: Ichthyoplankton. In: Allen, L.G., D.J. Pondella, and M.H. Horn, eds. Ecology of marine fishes: California and adjacent waters. Berkeley, CA: University of California Press. Pp. 269-319.
- Neighbors, M.A. and Wilson Jr., R.R. 2006. Chapter thirteen: Deep sea. In: Allen, L.G., D.J. Pondella, and M.H. Horn, eds. Ecology of marine fishes: California and adjacent waters. Berkeley CA: University of California Press. Pp. 342-382.
- Nishimoto, M.M. and L. Washburn. 2002. Patterns of coastal eddy circulation and abundance of pelagic juvenile fish in the Santa Barbara Channel, California, USA. Marine Ecology Progress Series 241:183-199.
- Pacific Fishery Management Council (PFMC). 2005. Backgrounder: Highly migratory species. Internet website: <http://www.pcouncil.org/hms/hmsback.html>. Accessed May 2009.
- Pacific Fishery Management Council (PFMC). 2008. Backgrounder: Essential fish habitat. www.pcouncil.org/facts/habitat.pdf: 5 pp.
- Pinnegar, J.K., N.V.C. Polunin, P. Francour, F. Badalamenti, R. Chemello, M.L. Harmelin-Vivien, B. Hereu, M. Milazzo, M. Zabala, G. D'Anna and C. Pipitone. 2000. Trophic cascades in benthic marine ecosystems: lessons for fisheries and protected-area management. Environmental Conservation 27(2):179-200.
- Santos, A.M.P., P. Re, A. Dos Santos and Á Peliz. 2006. Vertical distribution of the European sardine (*Sardina pilchardus*) larvae and its implications for their survival. Journal of Plankton Research 28:523-532.
- Saunders, M.W. and G.A. McFarlane. 1997. Observations of the spawning distributions and biology of offshore Pacific hake (*Merluccius productus*). California Cooperative Oceanic Fisheries Investigations (CalCOFI) Reports Vol. 38:147-157.
- Schroeder, D.M. and M.S. Love. 2002. Recreational fishing and marine fish populations in California. California Cooperative Oceanic Fisheries Investigations (CalCOFI) Reports Vol. 43:182-190.
- Schwing, F.B., N.A. Bond, S.J. Bograd, T. Mitchell, M.A. Alexander and N. Mantua. 2006. Delayed coastal upwelling along the U.S. West Coast in 2005: A historical perspective. Geophysical Research Letters 33, L22s01, doi:10.1029/2006GL026911.

- Smith, P.E. and H.G. Moser. 2000. Long-term trends and variability in the larvae of Pacific sardine and associated fish species of the California Current region. *Deep-sea Research II* 50: 2519-2536.
- Stephens Jr., J.S., R.J. Larson and D.J. Pondella. 2006. Chapter nine: Rocky reefs and kelp beds. In: Allen, L.G., D.J. Pondella, and M.H. Horn, eds. *Ecology of marine fishes: California and adjacent waters*. Berkeley, CA: University of California Press. Pp. 227-252.
- Tagging of Pacific Pelagics (TOPP). 2009. TOPP near real-time animal tracks, Southern California Bight. Internet website: <http://las.pfeg.noaa.gov/TOPP/browse.html>. Accessed May 2009.
- U.S. Dept. of the Interior, Minerals Management Service (MMS). 2001. Delineation drilling activities in Federal waters offshore Santa Barbara County, California, draft environmental impact statement. U.S. Dept. of the Interior, Minerals Management Service, Pacific OCS Region, Camarillo, CA. MMS OCS EIS/EA 2001-046.
- U.S. Dept. of the Interior, Minerals Management Service (MMS). 2007. Programmatic environmental impact statement for alternative energy development and production and alternate uses of facilities on the Outer Continental Shelf, Volume I: Executive summary through chapter 4. U.S. Dept. of the Interior, Minerals Management Service. OCS EIS/EA MMS 2007-046.
- Vilchis, L.I., L.T. Ballance and W. Watson. 2009. Temporal variability of neustonic *ichthyoplankton* assemblages of the eastern Pacific warm pool: Can community structure be linked to climate variability? *Deep-Sea Research I* 56:125-140.
- Watson, W., R.L. Charter, H.G. Moser, D.A. Ambrose, S.R. Charter, E.M. Sandknop, L.L. Robertson and E.A. Lynn. 2002. Distributions of planktonic fish eggs and larvae off two state ecological reserves in the Santa Barbara Channel vicinity and two nearby islands in the Channel Islands National Marine Sanctuary, California. *California Cooperative Oceanic Fisheries Investigations (CalCOFI) Reports* Vol. 43. Pp. 141-154.

8. SEA TURTLES

Sea turtles inhabit tropical and subtropical seas and are relatively uncommon in northeastern Pacific waters north of Mexico. Historically, four species of sea turtles have been recorded in the northeastern Pacific: the green sea turtle (*Chelonia mydas*), the leatherback sea turtle (*Dermochelys coriacea*), the loggerhead sea turtle (*Caretta caretta*), and the Pacific (or olive) ridley sea turtle (*Lepidochelys olivacea*) (USDOC, NMFS & USDO, USFWS 1998a,b,c,d). Sea turtle populations have been greatly reduced by overharvesting, fisheries by-catch, disease, pollution, and coastal development of nesting beaches (Lewison and Crowder 2007). All species of sea turtles are listed as either threatened or endangered (Table 8.1) and trade is restricted by the Convention on International Trade in Endangered Species (CITES); however, not all countries adhere to a no-take policy and harvesting continues to be a threat to these species.

Table 8.1.

Conservation status of all species of sea turtles found in the Southern Study Area

Species	Federal Listing	California Listing
Green Sea Turtle <i>Chelonia mydas</i>	Threatened; breeding Mexico (Pacific) population endangered	none
Leatherback Sea Turtle <i>Dermochelys coriacea</i>	Endangered	none
Loggerhead Sea Turtle <i>Caretta caretta</i>	Threatened	none
Olive Ridley Sea Turtle <i>Lepidochelys olivacea</i>	Threatened; Mexico (Pacific) population Endangered	none

(CA DFG 2009)

Green sea turtles, also known as black sea turtles, are found worldwide in waters that remain above 20°C year-round. The Southern California Bight is beyond the breeding limits of the green turtle but these turtles are often sighted feeding there during summer months (USDOC, NMFS & USDO, USFWS 2007a). In the Pacific, green turtles are federally listed as threatened, except for Mexican breeding populations, which are listed as endangered (USDOC, NMFS & USDO, USFWS 2007a). These populations are reported to be stable or increasing from the population low during the mid 1980s to 1990s (USDOC, NMFS & USDO, USFWS 2007a). The eastern Pacific population includes a small, year-round, nonbreeding colony of between 60 and 100 individuals in San Diego Bay (USDOC, NMFS & USDO, USFWS 2007a). It is believed that the thermal effluent from a power plant allows this population to live year-round in the bay (USDOC, NMFS & USDO, USFWS 2007a). A similar phenomenon has been observed in Los Angeles, where green turtles have been residing in the San Gabriel River (Sahagun 2008).

Leatherback sea turtles, the largest of the sea turtles, occur in the Atlantic, Indian, and Pacific Oceans (USDOC, NMFS & USDO, USFWS 2007b). Leatherbacks commonly range farther north than other sea turtles, probably because of their ability to maintain warmer body temperatures over longer time periods (USDOC, NMFS 2009), and they have been sighted in the eastern North Pacific as far north as Alaska (USDOC, NMFS & USDO, USFWS 2007b). Despite being federally listed as endangered in 1970, leatherbacks are the most common sea turtle in U.S. West Coast waters (USDOC, NMFS & USDO, USFWS 1998b). However, many

of these sightings are reports of entanglement in commercial fishing gear off Washington, Oregon, and California (USDOC, NMFS & USDO, USFWS 1998b). This concern over the rate of by-catch was voiced in a petition to the National Marine Fisheries Service (NMFS) requesting new designations of critical habitat for this species along the entire West Coast of the U.S. (USDOC, NMFS 2009). A critical habitat review was completed by NMFS and the proposed locations are currently out for public comment (75 FR 319). Other threats to this species includes degradation of nesting habitats; estimates of nesting females at beaches in the eastern Pacific vary widely but show that populations have been declining rapidly. Beaches that were visited by over 1,300 females in the late 1980s were visited by less than 200 in the early 2000s (USDOC, NMFS & USDO, USFWS 2007b).

Loggerhead sea turtles inhabit subtropical to temperate waters worldwide, and are generally found in waters over the continental shelf. In the Pacific, loggerheads nest only in the western region, primarily near Japan and Australia (USDOC, NMFS & USDO, USFWS 1998c). Sightings from the West Coast of the United States are primarily of juveniles seen within the Southern California Bight, although a few sightings have been reported in Washington and Alaska (USDOC, NMFS & USDO, USFWS 1998c). The loggerhead was federally listed as threatened in 1978. Nesting populations have not been monitored with enough frequency to conclude a long-term trend (USDOC, NMFS & USDO, USFWS 2007c).

Pacific, or olive, ridley sea turtles are the smallest of the sea turtles. Olive ridleys occur worldwide in tropical to warm temperate waters and are considered to be the most abundant sea turtle in the world (USDOC, NMFS & USDO, USFWS 1998d). The species was federally listed in 1978; Pacific ridleys on the Pacific Coast of Mexico are listed as endangered, all other populations as threatened. An at-sea estimate of the population in the eastern Pacific is 1.39 million (USDOC, NMFS & USDO, USFWS 2007d). Hubbs (1977) observed a pair of Pacific ridleys mating in the water off La Jolla, San Diego County, California. However, these sea turtles are infrequent visitors to waters north of Mexico. In the eastern Pacific, the species' main foraging areas extend to the south between Mexico and Colombia.

8.1 MIGRATION

Of the four species of sea turtles found in the eastern Pacific, two exhibit an oceanic-neritic developmental pattern and two are believed to develop solely in oceanic habitats. Loggerhead and green turtles migrate to oceanic foraging grounds as hatchlings and remain there during their juvenile development stage. They then return to neritic (nearshore) habitats as late-stage juveniles and finish their development. As adults these species remain in neritic foraging grounds, where they feed primarily on benthic organisms (Lutz et al. 2003). Olive ridley and leatherback turtles are thought to be oceanic developers. While little is known about their migratory patterns, these species are believed to develop in oceanic waters and maintain their pelagic nature as adults (Lutz et al. 2003). Recent studies suggest that the leatherback may spend more time in neritic waters than previously thought as they forage for food (reviewed in USDOC, NMFS 2009).

As adults, sea turtles migrate between foraging grounds and nesting beaches. Natal site fidelity is strong among all species and breeding-associated migration occurs every 1 to 5 years

depending on the species (Lutz et al. 2003). Many individuals have been tagged and followed on circumglobal routes between nesting and foraging locations, which can be hundreds to thousands of kilometers apart (Luschi et al. 2003). The West Coast of the Americas is a common place to find sea turtles. All four species found in the study area nest on the Pacific tropical coasts and forage to the north and south. In the northern hemisphere, the summer upwelling off Northern California and Oregon draws turtles to feed on the seasonal productivity (Peterson et al. 2006; USDOC, NMFS 2009). Loggerheads and leatherbacks have been observed as far north as British Columbia and Alaska (USDOC, NMFS & USDO, USFWS 1998b,c; USDOC, NMFS 2009). This creates a migration corridor along the entire length of North America, including the Southern California Bight.

8.2 FORAGING

All species of sea turtles are omnivorous; major food items often depend on season and preferred foraging ranges. Species that spend more time in neritic waters feed on benthic organisms, whereas species that are more oceanic feed primarily on pelagic prey items. There is no documentation of specific foraging events within the Southern California Bight between sea turtles and individual prey items (USDOC, NMFS & USDO, USFWS 2007a, b, c, d), although San Diego Bay is noted as an important foraging location for green turtles (USDOC, NMFS & USDO, USFWS 2007a). For the remaining species, foraging grounds north and breeding grounds south or west of this location make the Southern California Bight a possible stopover during migration (USDOC, NMFS & USDO, USFWS 2007a, b, c, d; Shester 2007).

Green sea turtles are primarily herbivorous, although those of the eastern Pacific may be more carnivorous (Lutz and Musick 1997). These turtles feed on seagrasses and algae as well as animal food items including mollusks, crustaceans, bryozoans, sponges, jellyfish, polychaetes, echinoderms, fish, and fish eggs (Lutz and Musick 1997; USDOC, NMFS & USDO, FWS 1998a; Seminoff et al. 2002; Boyle and Limpus 2008).

Although considered omnivorous (feeding on sea urchins, crustaceans, fish, and floating seaweed), leatherbacks feed principally on soft foods such as cnidarians (medusae, siphonophores) and tunicates (salps, pyrosomas) (Lutz and Musick 1997; USDOC, NMFS & USDO, USFWS 1998b). Late summer and fall upwelling activity off the coasts of Washington, Oregon, and Northern California produce large aggregations of jellyfish (*Chrysaora* spp.) and are a large resource for leatherbacks (Peterson et al. 2006; USDOC, NMFS 2009; 35 FR 319). This productivity draws animals from all over the Pacific basin, potentially creating a migration corridor through the Southern Study Area. Leatherbacks also may forage nocturnally at depth on siphonophores and salps in the deep scattering layer (USDOC, NMFS & USDO, USFWS 1998b).

Loggerhead sea turtles are omnivorous, feeding on a variety of benthic prey including shellfish, crabs, barnacles, oysters, jellyfish, squid, and sea urchins, and occasionally on fish, algae, and seaweed (Lutz and Musick 1997; USDOC, NMFS & USDO, USFWS 1998c; Boyle and Limpus 2008).

Olive ridley turtles are considered omnivorous, feeding on a variety of benthic and some pelagic items (USDOC, NMFS & USDO, USFWS 1998d). Identified prey includes fish, crabs, shrimp, snails, oysters, sea urchins, jellyfish, salps, fish eggs, and vegetation (Lutz and Musick 1997; USDOC, NMFS & USDO, USFWS 1998d). Pacific ridleys may also scavenge (USDOC, NMFS & USDO, USFWS 1998d).

8.3 NESTING

In the eastern Pacific, most sea turtles nest on the Pacific Coasts of Mexico and Central America. The age at which sea turtles reach sexual maturity varies considerably between and within species, ranging from as few as several years to as long as two decades (Shigenaka 2003). They breed at sea, and the females instinctively return to their natal beaches to lay eggs. Females typically nest one to ten times during the nesting season, again depending upon the species, with clutch sizes of 80 to 150 eggs. About 2 months after being laid in the sand, eggs hatch, and the young instinctively make for the sea (Shigenaka 2003). Once at sea the males very rarely, if ever, return to land.

There are no known nesting beaches in the Southern Study Area for any of the turtle species observed in the offshore waters (USDOC, NMFS & USDO, USFWS 2007a, b, c, d). However, several of these species have important nesting grounds just south of the border in Mexico. The eastern Pacific population of green turtles is listed separately from the worldwide population as endangered; these turtles nest primarily in Mexico (USDOC, NMFS & USDO, USFWS 1998a). The largest nesting sites are located on the mainland south of Puerto Vallarta (USDOC, NMFS & USDO, USFWS 2007a) and are unlikely to be affected by development in the Southern California Bight. However, smaller nesting locations in closer proximity to oil and gas production activities could be affected by oil coming onshore in Mexico.

8.4 BY-CATCH

The decline in the world's populations of sea turtles has been documented primarily as the declining numbers of nests. These declines are due to many factors including harvesting, development of coastal nesting sites, and by-catch in fishing gear. Since all species of sea turtles are now considered threatened or endangered, the harvesting has mostly ceased; however, the development of coastal habitats and by-catch are important factors that continue to negatively impact these populations.

On the coast of California north of Point Sur, the gillnet fishery for swordfish and thrasher shark is closed August through November to protect loggerhead turtles that might be in the area (Carretta et al. 2005). Unfortunately, this only acts to concentrate the fishing effort in the southern region, where presumably turtles are also found as they migrate south for warmer waters in the winter. Carretta et al. (2005) estimated that over 700 turtles were killed by the gillnet fishery between 1996 and 2002. This is of particular concern since populations have been rapidly declining in recent years. Another study focusing on the effects of the longline fishery on the Pacific populations of leatherbacks found this fishery caused 5 percent annual mortality (Kaplan 2005). While this may not appear to be a large component to mortality, this fishery is believed to affect older, more reproductively important individuals, whose health and survival

are more important to the population than those of younger individuals (Lewison and Crowder 2007).

These and other fisheries contribute to the decline of these sensitive populations, which for leatherbacks, the most common species in West Coast U.S. waters, were estimated at less than 1,700 individuals in 2000 (Spotila et al. 2000). A recently proposed rule by the National Marine Fisheries Service (NMFS) under the National Oceanic and Atmospheric Administration (NOAA) would designate a large portion of the West Coast of the U.S. as critical habitat for this species (75 FR 319). The proposed areas in the Southern Study Area include nearshore and offshore waters from Point Vicente, Los Angeles County, north beyond the Santa Barbara/San Luis Obispo County boundary; including all waters around the California Channel Island National Marine Sactuary. These areas were chosen because they are where the major aggregations of jellyfish arise in the late summer and fall months, which are a major food source for leatherbacks (Peterson et al. 2006; USDOC, NMFS 2009).

8.5 SUMMARY AND DATA GAPS

Current information suggests the majority of sea turtles found in the Southern California Bight are individuals migrating between feeding and breeding grounds. The bight is a biologically diverse region but does not offer a large source of food production and therefore is not a major destination for these animals. However, alterations to the environment, specifically the increase of nearshore water temperatures due to thermal effluents, have created new habitat in the region. The increased number of animals in the area requires continued monitoring and protection as the world populations continue to decline.

While much more information about these long-lived species is becoming available with the advancement of satellite-telemetry technology, little remains known about the post-hatchling stages. Additionally, comprehensive population estimates are hard to compile because of the solitary nature and wide distribution of individuals.

8.6 LIST OF LITERATURE CITED—SEA TURTLES

Boyle, M. and C. Limpus. 2008. The stomach contents of post-hatchling green and loggerhead sea turtles in the southwest Pacific: An insight into habitat association. *Marine Biology* 155 (2):233-241.

California Department of Fish and Game (CA DFG). 2009. State and federally listed endangered and threatened animals of California. Internet website: <http://www.dfg.ca.gov/biogeodata/cnddb/pdfs/TEAnimals.pdf>. Accessed June 2009.

Carretta, J., T. Price, D. Petersen and R. Read. 2005. Estimates of marine mammal, sea turtle, and seabird mortality in the California drift gillnet fishery for swordfish and thresher shark, 1996-2002. *Marine Fishery Review* 66(2):21-30.

Hubbs, C. 1977. First record of mating of ridley turtles in California, with notes on commensals, characters, and systematics. *California Fish and Game* 63(4):263-267.

- Kaplan, I.C. 2005. A risk assessment for Pacific Leatherback Turtles (*Dermochelys coriacea*). *Conservation Biology* 62:1710-1719.
- Lewison, R.L. and L.B. Crowder. 2007. Putting longline bycatch of sea turtles into perspective. *Conservation Biology* 21(1):79-86.
- Luschi, P., G.C. Hays and F. Papi. 2003. A review of long-distance movements by marine turtles, and the possible role of ocean currents. *Oikos* 103(2):293-302.
- Lutz, P. and J. Musick. 1997. *Biology of Sea Turtles*. Boca Raton, FL: CRC Press.
- Lutz, P., J. Musick and J. Wynken. 2003. *Biology of Sea Turtles Volume II*. Boca Raton, FL: CRC Press.
- Peterson, W., R. Emmett, R. Goericke, E. Venrick, A. Mantyla, S. Bograd, F. Schwing, R. Hewitt, N. Lo and W. Watson. 2006. The state of the California Current, 2005-2006: Warm in the north, cool in the south. *Reports of California Cooperative Oceanic Fisheries (CalCOFI) Investigations* 47:30-74.
- Sahagun, L. 2008. "Sea turtles explore new, urban frontier." *Los Angeles Times*. 30 August 2008: B-1.
- Seminoff J.A., A. Resendiz and W.J. Nichols. 2002. Diet of east Pacific green turtles (*Chelonia mydas*) in the central Gulf of California, Mexico. *Journal of Herpetology* 36(3):447-453.
- Shester, G. 2007. *Forging a Future for Pacific Sea Turtles*. In: *Oceana*. U.S. Pacific. Monterey, California.
- Shigenaka, G. 2003. *Oil and Sea Turtles: Biology, Planning, and Response*. U.S. Dept. of Commerce, National Oceanic and Atmospheric Administration, NOAA's National Ocean Service, Office of Response and Restoration.
- Spotila, J., R. Reina, A. Steyermark, P. Plotkin and F. Paladino. 2000. Pacific leatherback turtles face extinction. *Nature* 405(6786):529-530.
- U.S. Dept.of Commerce, National Marine Fisheries Service (NMFS) and U.S. Dept. of the Interior, U.S. Fish and Wildlife Service (USFWS). 1998a. *Recovery Plan for U.S. Pacific Population of the Green Turtle (Chelonia mydas)*. U.S. Dept. of Commerce, National Oceanic and Atmospheric Administration, National Marine Fisheries Service, U.S. Dept. of the Interior and U.S. Fish and Wildlife Service.
- U.S. Dept.of Commerce, National Marine Fisheries Service (NMFS) and U.S. Dept. of the Interior, U.S. Fish and Wildlife Service (USFWS). 1998b. *Recovery Plan for U.S. Pacific Population of the Leatherback Turtle (Dermochelys coriacea)*. U.S. Dept. of Commerce, National Oceanic and Atmospheric Administration, National Marine Fisheries Service, U.S. Dept. of the Interior and U.S. Fish and Wildlife Service.

- U.S. Dept.of Commerce, National Marine Fisheries Service (NMFS) and U.S. Dept. of the Interior, U.S. Fish and Wildlife Service (USFWS). 1998c. Recovery Plan for U.S. Pacific Population of the Loggerhead Turtle (*Caretta caratta*). U.S. Dept. of Commerce, National Oceanic and Atmospheric Administration, National Marine Fisheries Service, U.S. Dept. of the Interior and U.S. Fish and Wildlife Service.
- U.S. Dept.of Commerce, National Marine Fisheries Service (NMFS) and U.S. Dept. of the Interior, U.S. Fish and Wildlife Service (USFWS). 1998d. Recovery Plan for U.S. Pacific Population of the Olive Ridley Turtle (*Lepidochelys olivacea*). U.S. Dept. of Commerce, National Oceanic and Atmospheric Administration, National Marine Fisheries Service, U.S. Dept. of the Interior and U.S. Fish and Wildlife Service.
- U.S. Dept.of Commerce, National Marine Fisheries Service (NMFS) and U.S. Dept. of the Interior, U.S. Fish and Wildlife Service (USFWS). 2007a. 5 Year Review of Green Turtles. U.S. Dept.of Commerce, National Oceanic and Atmospheric Administration (NOAA) and National Marine Fisheries Service (NMFS).
- U.S. Dept.of Commerce, National Marine Fisheries Service (NMFS) and U.S. Dept. of the Interior, U.S. Fish and Wildlife Service (USFWS). 2007b. 5 Year Review of Leatherback Turtles. U.S. Dept.of Commerce, National Oceanic and Atmospheric Administration (NOAA) and National Marine Fisheries Service (NMFS).
- U.S. Dept.of Commerce, National Marine Fisheries Service (NMFS) and U.S. Dept. of the Interior, U.S. Fish and Wildlife Service (USFWS). 2007c. 5 Year Review of Loggerhead Turtles. U.S. Dept.of Commerce, National Oceanic and Atmospheric Administration (NOAA) and National Marine Fisheries Service (NMFS).
- U.S. Dept.of Commerce, National Marine Fisheries Service (NMFS) and U.S. Dept. of the Interior, U.S. Fish and Wildlife Service (USFWS). 2007d. 5 Year Review of Olive Ridley Turtles. U.S. Dept.of Commerce, National Oceanic and Atmospheric Administration (NOAA) and National Marine Fisheries Service (NMFS).
- U.S. Dept.of Commerce, National Marine Fisheries Service (NMFS). 2009. Revision of Critical Habitat for Leatherback Sea Turtles: Biological Report. U.S. Dept.of Commerce, National Marine Fisheries Service, Office of Protected Resources: November 2009.

9. BIRDS

The Southern Study Area is utilized by hundreds of bird species, which take advantage of the coastal and aquatic habitats and resources. The area is frequented by migratory species and is home to resident species. Many species breed in the study area, and a few breed exclusively within the Southern California Bight. Adding to the diversity of bird species is that this area is the northern or southern range limit for many. Birds found in this region fall into several categories; this chapter will discuss marshbirds (herons, rails, cranes, ibises), waterbirds (ducks, geese, coots, grebes), shorebirds, and seabirds (birds found on or near coastal or offshore habitats).

9.1 HABITATS

The Southern California Bight offers a wide range of habitats for coastal bird species, which are utilized by both resident and migratory species. The mainland habitats, including beaches, estuaries, and marshlands, have been largely modified or degraded by human development and use. Conversely, the California Channel Islands off the coast have remained relatively undisturbed by human activity (Dugan et al. 2000).

Sandy beaches comprise a large portion of the Southern California coast. This habitat is highly variable depending on many physical factors including tidal height, wave action and storm surge; sand grain size; macroalgal wrack distribution; and spatial extent (Hubbard and Dugan 2003; Dugan 2006). In Southern California many beaches are limited by backing features including bluffs and human development. This means that available habitat is finite and change in tidal height can have a large and fluctuating impact on available space. Major prey items in this habitat are macroinvertebrates that live either in the sand or on the kelp wrack that washes ashore (Dugan et al. 2000).

The geomorphology of Southern California is not conducive to the establishment of protected wetland habitats, including embayments, estuaries, and marshes ([see Chapter 2](#)). These habitats are often located at the mouths of large rivers, which are not a common feature of the southern Pacific Coast of the United States. The few rivers that do meet the sea in this region have been heavily modified by human use through either the diversion of waters upstream or development along sensitive areas near the coast. Because of these activities the amount of wetland habitat is quite small throughout the Southern Study Area.

The Channel Islands offer a large amount of relatively undisturbed habitat that many bird species use for breeding grounds. The variety of habitats found on the islands, from sandy and rocky beaches to rocky cliffs and inland brush vegetation, provide semi-protected areas for species seeking safe breeding grounds. Many seabirds nest on the cliffs of the Channel Islands and forage off the coast (Mason et al. 2007).

9.2 DISTRIBUTION AND ABUNDANCE

9.2.1 Marshbirds

Marshbirds commonly feed in coastal wetlands and nest at locations farther inland. Several species of herons and rails breed in the Southern California Bight though overall marshbird populations are lowest during the breeding season (Baird 1993). The great blue heron (*Ardea herodias*), snowy egret (*Egretta thula*), green-backed heron (*Butorides striatus*) and black-crowned night heron (*Nycticorax nycticorax*) are the most common nesters. Herons and egrets nest in and around wetlands of all varieties, usually removed from human activity. Nesting sites are usually located close to foraging areas, and fledging success increases with increasing food availability (Kelly et al. 2007). Great blue herons usually occupy nests through June, whereas the other marshbirds may remain with nests into August (Kelly et al. 2007). The black-crowned night herons nest in trees and bushes in coastal areas and breed March through August in Southern California (Crouch et al. 2002).

Herons are found in the Southern Study Area year round with greatest numbers in the winter (Baird 1993). These species are found in most coastal aquatic habitats, especially in estuaries. Egrets are also found in many different habitats. Snowy egrets can even be found utilizing rocky shorelines during migration (Baird 1993).

The white-faced ibis (*Plegadis chihi*) has been in decline in the Southern Study Area for many years (Baird 1993). This decline is likely due to the loss of coastal marshes. This species requires extensive, shallow, grassy marshes for breeding; such areas have been in a steep decline due to development. This species was also negatively impacted by DDT in the environment (Baird 1993).

Rail populations have suffered population declines mostly due to habitat degradation. The light-footed clapper rail (*Rallus longirostris levipes*), endemic to Southern California, is the most at risk and is now protected under the Federal Endangered Species Act (see below). Other rail species, including Virginia (*R. limicola*), sora (*Porzana carolina*), and black rails (*Laterallus jamaicensis*) have also seen population numbers decline (Baird 1993). These species utilize both salt and inland marshes.

9.2.2 Waterbirds

Most waterbirds are more common on protected bodies of water, and in the Southern Study Area this includes mainly inland lakes and ponds. The heavy use of most coastal and protected saltwater habitats has helped to further encourage these populations to seek habitat farther inland. Waterbirds are most common in winter and migrate north to breed in the summer (Baird 1993). Northern shovelers (*Anas clypeata*) and American widgeons (*Arias americana*) are typical examples of large winter populations that utilize the coast, lagoons, estuaries, and inland water bodies.

Teals (*Arias* spp.: northern pintail, green-winged, cinnamon) are common during all seasons. The northern pintail (*A. acuta*) is the most abundant dabbler during fall and winter, with numbers in the thousands. They arrive to the mainland via the open ocean. Green-winged teals (*A.*

crecca) are one of the most numerous dabblers found during the winter months (Baird 1993). Cinnamon teals (*A. cyanoptera*) can be found on the Channel Islands during the summer after the spring migration (Baird 1993).

Grebes (*Aechmophorus* spp.: western, Clark's) are common along the mainland coast in January and May while relatively scarce in September (Mason et al. 2007). These species breed primarily on lakes and reservoirs in central and Northern California; only one coastal site in Southern California has been identified as a grebe colony location: Buena Vista Lagoon in San Diego County (Ivey 2004). During the winter, when many inland lakes are frozen, these species forage on small fish in coastal areas (Ivey 2004).

9.2.3 Shorebirds

Shorebirds are common in the Southern Study Area and utilize all shore types, feeding in shallow waters of the open coast, embayments, and estuaries. Sandy beaches account for the majority (66-93 percent) of the coast in each of the counties along the Southern California Bight (Dugan 2006). Shorebirds feed in shallow water, consuming large quantities of food because of their high metabolic rates. Rich and productive food reserves are an important resource for these populations (Dugan 2006). Species commonly found on sandy coasts include sanderling (*Calidris alba*), black-necked stilt (*Himantopus mexicanus*), snowy plover (*Charadrius alexandrinus*), and spotted sandpipers (*Actitis macularia*) (Baird 1993). Estuaries are also important habitat for shorebirds; these areas offer a more protected environment. Species commonly found around the estuaries of the Southern Study Area include American avocet (*Recurvirostra americana*), killdeer (*Charadrius vociferous*), long-billed dowitchers (*Limnodromus scolopaceus*), lesser yellowlegs (*Tringa flavipes*), and western and least sandpipers (*Calidris mauri* and *C. minutilla*) (Baird 1993). Shorebirds found in many habitats, including the rocky coasts, include the black-bellied plover (*Pluvialis squatarola*) and willets (*Catoptrophorus semipalmatus*) (Baird 1993). Several species prefer estuaries with *Salicornia* vegetation, including long-billed curlews (*Numenius americanus*) and marbled godwit (*Limosa fedoa*). Black turnstones (*Arenaria melanocephala*) and black oystercatchers (*Haematopus bachmani*) are usually found on rocky coasts and therefore are not common on the mainland (Page and Shuford 2000).

A six-year survey of shorebirds on an exposed sandy beach in Santa Barbara County found a diverse community throughout the year comprised of both resident and temporary members. Hubbard and Dugan (2003) recorded the presence of 26 shorebirds during this survey; overall abundance was highest in the fall and lowest during summer months. The most common shorebird was the sanderling (*Calidris alba*), which accounted for 64 percent of the total abundance; they occurred in highest abundances June through November and were scarce during summer months. Semipalmated plovers (*Charadrius semipalmatus*) were also very common, occurring throughout the year with a major peak in abundance in August and a minor peak in the spring. Marbled godwits (*Limosa fedoa*) were found in highest abundance during the winter, occurring later in the season than most of the other species observed, and were absent during summer months. Black-bellied plovers (*Pluvialis squatarola*) were observed frequently but in smaller numbers, often occurring singularly. Western sandpipers (*Calidris mauri*) occurred only in spring and fall migration periods. Hubbard and Dugan (2003) report peak abundances of

snowy plovers (*Charadrius alexandrinus*) on sandy beaches during August-September, but do not indicate if they are the threatened subspecies (*C. alexandrinus nivosus*).

9.2.4 Seabirds

A seabird survey of the Southern California Bight was carried out in May, September and January for 3 consecutive years (May 1999-January 2002) by Mason et al. (2007). This study found 54 species and reported highest densities associated with the mainland and island coastlines. Temporally, densities were greatest in January; spatially, near the northern Channel Islands. The January surveys were dominated by California gulls, western grebes, and Cassin's auklets, while sooty and short-tailed shearwaters, phalaropes, and western gulls were most common May and September. Mason et al. (2007) compared their results with those from surveys in the 1970s and 1980s. Overall, seabird density in the Southern California Bight has declined compared to historical figures, with common murrelets, sooty shearwaters, and Bonaparte's gulls recording the largest declines. However, brown pelicans, Xantus' murrelets, Cassin's auklets, and ashy storm-petrels had increased densities.

A similar trend was reported in another seabird survey synthesized by Hyrenbach and Veit (2002). A ten-year compilation of California Cooperative Oceanic Fishing Investigations (CalCOFI) seabird data (1987-1998) showed a trend in warming ocean waters and decreased productivity across many trophic levels. The authors documented changes in the seabird community composition during this period of declining productivity. Changes in seabird densities have been shown to correlate with environmental conditions including sea surface temperature and El Niño conditions (Veit et al. 1996; Sydeman et al. 2001; Hyrenbach and Veit 2002). Hyrenbach and Veit (2002) found the black storm-petrel, the black-vented shearwater, and the least storm-petrel were indicators of El Niño conditions; Cassin's auklet, the rhinoceros auklet, and the sooty shearwater were indicator species for cold water affinities; and Leach's storm-petrel, the pink-footed shearwater, and Xantus' murrelet were indicators of warmwater.

Loons (*Gravia* spp.: common, Pacific, red-throated) were found in high densities along the mainland coast and throughout the northern Channel Islands in January; lower densities were found in May and few were found in the region in September (Mason et al. 2007). Migration of the Pacific loon (*G. pacificus*) was documented by Russell and Lehman (1994). Highest traffic was recorded mid-April through May at a mainland sight in Santa Barbara County. Loons were observed utilizing the northern Channel Islands as stopover points; Russell and Lehman (1994) hypothesize this is influenced by the high productivity to the north of the islands.

Albatross (*Phoebastria* spp.: black-footed, Laysan) were common throughout the year. Highest densities occurred in September throughout the Southern California Bight. Similar distributions and lower abundances were seen in January. In May, densities were clustered along the mainland coastline (Mason et al. 2007). Another study found spring abundances of black-footed albatrosses to be greatest beyond the 3,000-m isobath (Yen et al. 2006).

Northern fulmars (*Fulmarus glacialis*) reach peak densities in January mostly over open water as they migrate through (Mason et al. 2007). They are much less abundant in May and nearly

absent in September. Another study found their spring-time densities to be highly variable between 1987 and 2002 (Yen et al. 2006).

Shearwater (Procellariidae: sooty, short-tailed, pink-footed, black-vented) densities varied greatly between species. Sooty and short-tailed shearwaters were most abundant in May and found throughout the Southern California Bight (Mason et al. 2007). Densities were moderate in September and clustered around the northern Channel Islands. Like sooty and short-tailed, pink-footed shearwaters were uncommon in January. Differently, pink-footed densities were low in May and much higher in September. The birds were well distributed throughout the Southern California Bight in both months. The black-vented shearwater was relatively uncommon, with low densities throughout the year, maximums occurring mostly along the coast. Sooty shearwaters (*Puffinus griseus*) from breeding colonies in New Zealand were tracked to three different wintering destinations in the North Pacific, one being the California Current (Shaffer et al. 2006). Shaffer et al. (2006) hypothesize that interannual variability in wintering populations around the North Pacific may have to do with variability in resource production in each location.

Storm-petrels (*Oceanodroma* spp.: Leach's, black, ashy) breed in the Southern California Bight in addition to other areas along the Pacific Coast of North America. Densities were low overall, with very few sighted in January. In May and September these species were spotted throughout the Bight (Mason et al. 2007). Another study found Leach's storm-petrel (*O. leucorhoa*) spring-time densities to be greatest over water deeper than 3,000 m (Yen et al. 2006). The ashy storm-petrel (*O. homochroa*) resides and breeds only on Californian islands and is on the California Department of Fish and Game species of concern list. During summer months, Adams and Takekawa (2008) found Santa Cruz Basin and western Santa Barbara Channel were the two most popular aggregation locations for foraging ashy storm-petrels that breed on several of the northern Channel Islands. It is believed these birds feed on the increased plankton productivity (crustaceans, larval fish, juvenile squid) found in the area during the summer upwelling season (Adams and Takekawa 2008). This species has also been monitored as part of the Montrose Settlements Restoration Program, because breeding success in the Southern California Bight had suffered as a result of egg thinning due to contamination by DDT and PCBs. This species was observed using artificial nest sites at several known breeding colonies on Santa Cruz Island (McIver et al. 2008). The spatial distribution of different species is partially due to ocean depth preference. Leach's storm-petrel is almost exclusively found over depths of between 200 and 2,000 m, whereas ashy and black storm-petrels are found over several depths. The ashy storm-petrel is commonly found at all depths over 200 meters and the black storm-petrel is most common at depths less than 2,000 m (Spear and Ainley 2007).

Cormorants (*Phalacrocorax* spp.: Brandt's, pelagic, double-crested) were common throughout the year in the Southern California Bight. Densities were clustered around the northern Channel Islands in all three months and extended to the southern islands in January (Mason et al. 2007). These species are visual predators that forage both solitarily and in groups. When foraging individually, Brandt's cormorant (*P. penicillatus*) were more likely to forage in kelp forests than in nonforested areas and over rocky reef substrates than over sandy bottoms (Hebshi 1998).

Scoters (*Melanitta* spp.: surf, white-winged) were most common in January occurring around the Channel Islands and coastal bays. In May and September the numbers decreased around the Islands but remained high at Morro and San Diego Bays (Mason et al. 2007).

Phalaropes (*Phalaropus* spp.: red, red-necked) densities were highest in May where they occurred throughout the Southern California Bight, and peak densities occurred over the Santa Barbara Channel. Densities in September had similar distributions but were lower, and in January densities were higher over the open ocean (Mason et al. 2007).

Twenty-two species of gulls (Laridae) were observed over the study. Densities were high during all three months and associated with the mainland and island coasts. High densities in January were due to large numbers of California gulls, which winter in the area (Mason et al. 2007).

The common murre (*Uria aalge*), which breeds only as far south as central California, was nearly absent from the Southern California Bight in May and September. Increased abundances were seen in January around the Santa Barbara Channel and south off San Diego (Mason et al. 2007).

Xantus' murrelets (*Synthliboramphus hypoleucus*) nests in Southern California, primarily on the Channel Islands. At-sea densities were highest in May; Xantus' murrelets were sighted more commonly near Santa Barbara and Anacapa islands (Mason et al. 2007).

Cassin's auklets (*Ptychoramphus aleuticus*) breed all along the Pacific Coast of North America including Southern California where the breeding population is mostly found on San Miguel Island. This species is a wing-propelled diving species that forages 10-30 m deep in search of plankton prey. In January this species was found throughout the northern part of the Bight and at least 10 km offshore (Mason et al. 2007). During nesting season, March through June, these birds are found foraging within 30 km of their nests (Adams et al. 2004). In September densities were greatly reduced (Mason et al. 2007).

Rhinoceros auklets (*Cerorhinca monocerata*) have been extending their breeding range over the past few decades and had only been occasionally seen on the Channel Islands prior to 1991 (McChesney et al. 1995). In 1991 a breeding survey recorded the presence of these birds on San Miguel Island displaying breeding behaviors. After this sighting it was believed this species had successfully extended its breeding range. Mason et al. (2007) recorded rhinoceros auklets in low densities around documented breeding areas in May and September. In January they were found throughout the Southern California Bight. Tufted puffins (*Fratercula cirrhata*) were also believed to have reestablished breeding populations in the early 1990s; however, none were observed by Mason et al. (2007) in their 1999-2002 study.

9.2.5 Raptors

Coastal raptors are at the top of the food web, consuming all types of prey from fish and smaller birds to the carrion of marine mammals. This group includes the bald eagle (*Haliaeetus leucocephalus*), peregrine falcon (*Falco peregrinus*), and osprey (*Pandion haliaetus*). The trophic position of these birds resulted in significant bioaccumulation of DDT and PCBs, toxins

that reduced reproductive success due to the thinning of egg shells (Sharpe et al. 2004). The disappearance of the bald eagle from the California Channel Islands during the 1960s occurred before the species was federally listed as endangered in the continental United States in 1978 (43 FR 6230 6233). Restoration of a Channel Islands population began in the 1980s with the reintroduction of birds to Santa Catalina Island (Sharpe 2003). However, success has been slow due to continued DDE (a derivative of DDT) contamination even though dumping of DDT has been banned since the early 1970s (Sharpe et al. 2004). It wasn't until the 1990s that eggs produced on the island were successfully hatched; continued success has been slow, with only 1-2 eggs hatching each year (Sharpe 2003). The bald eagle was officially removed from the endangered species list in 2007 (72 FR 37345 37372); however the Santa Catalina Island breeding population remains fragile as hatching success is still low (Sharpe 2003).

9.3 BREEDING AND REPRODUCTIVE ECOLOGY

Prey availability is an important factor affecting the reproductive success of most species. This holds true for the avifauna of the Southern Study Area. In this region, upwelling is the source of most of the productivity, and changes in this process can greatly alter the food availability. Yearly and decadal variation in upwelling productivity can affect the breeding success of species that rely on this food source. Depending on reproductive strategy, this can result in major population declines and even the abandonment of breeding grounds (McChesney et al. 1995; Sydeman et al. 2001; Sydeman et al. 2006; Anderson et al. 2007).

Many coastal marshbirds and waterbirds have adapted to reduced habitat availability by moving inland to comparable freshwater habitats. There is evidence that these colonies could move back to the coast and saltmarshes if habitats are restored (Crouch et al. 2002). Shorebirds that breed in the Southern Study Area include avocets, stilts, sandpipers, willets, oystercatchers, and killdeer (Baird 1993). Most shorebirds nest on the ground either on open beaches or in vegetation patches. Two endangered shorebirds also nest on the coast, the California least tern and the western snowy plover. These species both nest on open beaches with foraging grounds in close proximity. These species are often found together, as the snowy plover can benefit from the protective habits and colonial nesting pattern of the least tern (Powell 2001).

In the Southern California Bight, seabirds commonly nest on the shores and cliffs of the mainland coast and the California Channel Islands. Egg predation and food availability are two of the largest threats to the reproductive success rates of seabirds. Three species of seabirds nest exclusively in the Southern California Bight: black storm-petrels, Xantus' murrelets, and brown pelicans (Baird 1993). Xantus' murrelets had declining reproductive numbers from 1985-1997 (Sydeman et al. 2006); however additional surveys indicate that the population in the Channel Islands has not changed significantly when calculated over a longer time frame (1983-2002; Schwemm et al. 2003). This lack of change is a result of nest occupancy declining while egg hatching rates increase, potentially due to a density-dependent mechanism (Schwemm et al. 2003). Brown pelicans showed increased reproductive success in the 1980s followed by a period of decline in the 1990s (Sydeman et al. 2001). This is an expected trend for these animals, whose reproductive success has been shown to highly correlate with El Niño conditions (Anderson et al. 2007). Many other species of seabirds also, although not exclusively, nest in the Southern Study Area, including storm-petrels, cormorants, and auklets.

9.4 FORAGING ECOLOGY AND FOOD HABITS

Foraging grounds for marshbirds, waterbirds, and shorebirds include estuaries and embayments as well as coastal intertidal zones. All of these areas are heavily impacted by human use and degradation in the Southern Study Area. Additionally, these areas are sensitive to natural perturbations by storms and weather events. Birds feeding in shallow waters consume a variety of organisms consisting mainly of invertebrates. Diets can include terrestrial and aquatic organisms that do not reside in these areas but whose eggs and larvae can be foraged. Marshbirds commonly consume epifaunal or pelagic organisms including aquatic insects and larvae, and small fishes (Baird 1993). Shorebirds consume a wide spectrum of organisms: foraging technique usually dictates if a species consumes mainly epifaunal or infaunal organisms (Hui and Beyer 1998). Many shorebirds can be seen digging or probing for prey in the sediment on sandy beaches while other species forage for mollusks on rocky shores. The abundance of shorebirds on sandy beaches has been shown to be significantly correlated with prey biomass (Dugan 2006) and some species will seek other foraging areas when beaches become too crowded (Baird 1993).

Seabirds consume a wide variety of prey, including plankton, fishes, squid, and crustaceans. The highly productive waters of the Southern California Bight offer a rich selection of resources. Occurrence of seabirds in areas of high oceanic productivity is common throughout the world (Baird 1993). The dominant fish species changes throughout the year and the arrival of seabirds can often coincide with the increase in prevalence of a preferred prey type. The hydrology of the area can greatly influence the interannual productivity within the Southern California Bight and therefore the breeding success rates of the seabirds that rely on these resources. This was documented in 2005, when the Farallon Islands population of Cassin's auklets abandoned the breeding grounds after a shift in ocean currents failed to produce upwelling (and productivity), and so favorable conditions (Sydeman et al. 2006). Russell and Lehman (1994) suggest that Pacific loons time their migration through the Southern California Bight to coincide with upwelling despite unfavorable flying conditions. Several studies have documented varying responses of different seabird species to the overall decline in productivity seen in the Southern California Bight in the 1980s and 1990s (Veit et al. 1996; Hyrenbach and Veit 2002).

Most seabirds dive for their prey, though different species pursue prey to varying depths. Seabirds forage on plankton (phyto-, zoo-, and ichthyo-) and fishes (anchovies, rockfish), which are found in abundance in upwelling zones where productivity is high. Feeding in the top few meters are albatrosses, shearwaters, storm-petrels, gulls and terns (Baird 1993). These species also spend time sitting on the water in between feeding events. Cormorants, loons, grebes, scoters and alcids can pursue their prey deeper in the water column. This is advantageous during years when prey stocks may be found below the surface layer and out of the reach of surface feeders. Brown pelicans' diets consist mainly of northern anchovy, and their population numbers can fluctuate with the abundance of this stock (Baird 1993). Xantus' murrelets, which often forage well offshore, feed on many types of prey including larval, juvenile, and adult northern anchovies as well as other fish species including two associated with passive prey and convergence zones, bluefin driftfish and medusafish (Hamilton et al. 2004).

Some seabirds, including phalaropes, consume planktonic prey. When concentrated on the surface layer, then called neuston, this can be a rich food source. Plankton, because of its passive nature in the water, tends to aggregate in eddies and oceanic fronts. These hydrologic features are common in the Southern California Bight and fluctuate in space, time, and intensity throughout the yearly cycle. Phalaropes consume these resources by feeding on the surface while swimming and have been observed to exploit these prey resources near Santa Monica Bay (DiGiacomo et al. 2002).

9.4.1 Estimated Food Consumption

Shorebirds have high metabolic rates and consume a large percentage of intertidal productivity (Dugan 2006). Sandy beaches provide a large prey resource from which shorebirds can consume 35-60 percent of the standing stock during the winter season (Baird 1993).

In the Southern California Bight, seabirds consume 14-30 percent of fish stocks, enough to significantly impact prey biomass (Baird 1993). Overall, seabird biomass in the Southern California Bight is low compared with other locations along the Pacific Coast (Baird 1993), but it varies widely over the course of a year as migrants travel through and breeders arrive in the winter to nest. Comparatively, total fishing landings (commercial and sport) account for as much as twice as much biomass removal from the coastal waters of California as is consumed by all seabirds (Baird 1993).

9.5 MIGRATORY FLYWAYS

The West Coast of the Americas is highly productive due to regional upwelling as a result of oceanic currents. The production of these upwelling areas varies seasonally and many species have adapted to take advantage of these seasonal patterns. Radiotelemetry, a relatively new technology, is increasingly common in migration studies and offers a larger-scale view than has been available in the past. This has allowed researchers to track the migration of the sooty shearwater across the Pacific Ocean from breeding grounds in New Zealand to feed along the West Coast of North America (Shaffer et al. 2006). These birds generally return to the same feeding grounds every year and can make multiple stops on their way back to New Zealand. This migration pattern allows the birds to take advantage of productivity peaks in different locations around the Pacific Ocean (Shaffer et al. 2006). Using a more localized strategy, the ashy storm-petrel, which is endemic to the southern portion of the California Current System, is unlike most other sea birds in that it does not migrate long distances. However, the distribution of this species within its range fluctuates over the year as they move between foraging and breeding grounds (Adams and Takekawa 2008).

9.6 THREATENED AND ENDANGERED SPECIES

The unique characteristics of the Southern California Bight make it a destination for many migratory bird species and the home to several endemic species. Of the species found throughout the year in this area, several are listed as threatened or endangered by the U.S. Federal government or the State of California ([Table 9.1](#)). Shorebirds include the light-footed clapper rail, the California least tern, and the Western snowy plover. Seabirds include the California population of the brown pelican, and Xantus' murrelet.

The light-footed clapper rail (*Rallus longirostris levipes*), a resident species of the coastal wetlands from Southern California to northern Baja California, Mexico, was listed as federally endangered in 1973 (35 FR 16047). The major factor impacting this species is the lack of suitable nesting habitat (Massey and Zembal 1980; Zembal et al. 2007). The decline and potential recovery of this species have been documented by annual surveys beginning in 1980. The lowest recorded number of pairs occurred in 1985 with 142; the number has rebounded to 443 surveyed in 2007 (Zembal et al. 2007) Upper Newport Bay and the Tijuana Marsh National Wildlife Reserve contain the two largest subpopulations, which together account for 70 percent of the breeding population (Zembal et al. 2007). Despite continued yearly increases in breeding pairs this species is still at risk because most of the breeding locations are not resilient to rebound following weather-induced habitat modifications. Winter storms can force tides into breeding habitat and subsequent runoff can have a negative effect on breeding success (Baird 1993). Because of this, the population remains at risk for reduced numbers following any major storm season. The precarious nature of these circumstances is continually aided by the restoration of marshes throughout the Southern California Bight, but much more habitat needs to be restored before this species is removed from protection.

Table 9.1.

Conservation status of all species of birds found in the Southern Study Area

Species	Federal Listing	California Listing
California Brown Pelican <i>Pelecanus occidentalis californicus</i>	Endangered, proposed for delisting in 2008	Endangered, proposed for delisting in 2008
Light-footed Clapper Rail <i>Rallus longirostris levipes</i>	Endangered	Endangered
Western Snowy Plover <i>Charadrius alexandrinus nivosus</i>	Endangered	none
California Least Tern <i>Sterna antillarum brownii</i>	Endangered	Endangered
Xantus' Murrelet <i>Synthliboramphus hypoleucus</i>	none	Threatened

(California Department of Fish and Game 2009)

The California least tern (*Sterna antillarum brownii*) was federally listed as endangered in 1970 and state listed as endangered in 1971 (Marschalek 2006; USDOJ, USFWS 2006). In 2006, it was recommended for downlisting to threatened status (USDOJ, USFWS 2006). At the time of initial listing there were approximately 600 pairs of birds. Since then the population has increased to more than 7,000 pairs (USDOJ, USFWS 2006). This species, like many other bird species in the Southern California Bight, saw population reductions during strong El Niño years due to declines in breeding success (Massey et al. 1992). The least tern is a migratory species that resides and breeds in California from April through August. The fall migration moves the population farther south to Central America (USDOJ, USFWS 2006). In 2005, a survey of breeding in central and Southern California found that 84 percent of breeding pairs were found along the Southern California Bight in Los Angeles, Orange, and San Diego Counties

(Marschalek 2006). The species nests on sparsely vegetated, sandy soils along the open coast and protected embayments. The California least tern forages within close proximity to nesting sites and feeds on small fish and crustaceans found in shallow waters (USDOI, USFWS 2006).

The Pacific Coast population of the western snowy plover (*Charadrius alexandrinus nivosus*) was federally listed as threatened in 1993 under the Federal Endangered Species Act (USDOI, USFWS 2007a). This small shorebird nests on wide, sparsely vegetated beaches or other open soft sediments (Powell 2001). The decline of this population is mainly due to habitat loss, which is primarily due to development and alteration of habitat. A shorebird survey of 15 beaches along Santa Barbara and Ventura Counties found western snowy plovers were positively correlated with macroalgal wrack cover (Dugan 2006), which is often removed during beach grooming. Critical habitat for the western snowy plover has been designated in all of the counties boarding the Southern California Bight where nesting and wintering populations can be found (USDOI, USFWS 2007a). In Southern California nests are usually found less than 100 m from shore and in areas where there is an unobstructed route to the water (USDOI, USFWS 2007a). These birds are visual predators that forage on invertebrates at the surfline and in stranded macroalgal wrack. A study of the wintering and nesting populations throughout San Diego County found populations were relatively stable between 1994 and 1999 (Powell et al. 2002). Additionally, the most successful habitats were found on military property, which is protected from the heavy use that plagues most of the other beaches in the county (Powell et al. 2002).

The California brown pelican (*Pelecanus occidentalis californicus*) was federally listed as endangered in 1970 and was state listed as endangered in 1971 (35 FR 16047). The thinning of eggshells due to DDT and PCB contamination caused low reproductive success in the 1960s and was the primary reason for their listing. Populations began to recover after the use of DDT was prohibited in 1970. Less than 15 percent of the California subpopulation breeds in the United States; all breeding within the United States occurs around the Southern California Bight (Anderson et al. 2007; USDOI, USFWS 2007b). Breeding occurs at offshore islands and along the mainland of Mexico. The only breeding locations in the United States are the Anacapa Islands, Prince Island, and Santa Barbara Island (Anderson et al. 2007). These breeding locations account for the majority of nests found as part of the California subpopulation. A seabird survey found brown pelicans throughout the year in the Southern California Bight with highest densities along the mainland and island coastlines (Mason et al. 2007). Temporally, densities were highest in September and similar in January and May, which is consistent with other studies finding increased densities in the Southern California Bight following the breeding season (Strong and Jaques 2003). Pelicans are visual predators that dive after prey resulting in complete or partial penetration into the water. Pelicans roost to allow their plumage to dry after prolonged exposure to the water. In Southern California, roosting habitat is limited due to the prevalence of low-relief sand beaches and therefore most roosting occurs on man-made structures including breakwaters and jetties (Strong and Jaques 2003). Roosts of high quality are particularly important for night roosting. Pelicans need locations to roost that are buffered from predators and human disturbance; again these critical habitats are limited (Jaques and Strong 2003).

Xantus' murrelet (*Synthliboramphus hypoleucus*) was listed as a State threatened species by the California Fish and Game Commission in 2004 (California Department of Fish and Game 2004). This species, which is endemic to the northeastern Pacific, nests in the rocky cliffs of the Channel Islands, Coronado Island, and several Mexican islands. Nests are commonly located far above the surf. One colony's average nest height was 37 m above the surf (Schwemm et al. 2003), and yet predation of eggs by native and nonnative predators has been identified as one of the major hindrances to the population. One study has found that more successful breeding years occurred during periods of increased upwelling, when coastal productivity was higher throughout the food web (Roth et al. 2005). During the nonbreeding seasons, this bird is found from British Columbia to Baja California, averaging 100 km from shore (Karnovsky et al. 2005). Xantus' murrelets are most commonly found over the shallow continental slope (depth: 200-1,000 m), less frequently found at deeper depths (1,000-3,000 m), and uncommon over pelagic (more than 3,000 m) and continental shelf (less than 200 m) waters (Karnovsky et al. 2005). These birds are wing-propelled divers and their distribution is likely correlated with the distribution of their prey. During the breeding season, these birds were tracked foraging at an average distance greater than 100 km from the Santa Barbara Island colony (Whitworth et al. 2000). A comparison between years found the springtime distribution to vary, potentially due to resource distributions (Whitworth et al. 2000).

9.7 SUMMARY AND DATA GAPS

The highly productive nature of the Southern California Bight attracts many avian species to the area to feed and breed. Modification to the coastline has severely reduced the amount of suitable habitat for many of these species and this has been reflected in population declines. Additional fluctuations in population numbers are a result of changing productivity, which in turn results from changing oceanic conditions. Several species are currently listed as endangered and more are close to needing designation and protection.

Comprehensive reports on seabirds and shorebirds are readily available; however, the light-footed clapper rail is one of the only marshbirds for which there is a recurring census in the Southern Study Area. Many of the bird populations have declined due to reduction and degradation of habitat, and therefore would benefit greatly from monitoring programs.

9.8 LIST OF LITERATURE CITED—BIRDS

- Adams, J. and J. Takekawa. 2008. At-sea distribution of radio-marked Ashy Storm-Petrel (*Oceanodroma homochroa*) captured on the California Channel Islands. *Marine Ornithology* 36: 9-17.
- Adams, J., J. Takekawa and H.R. Carter. 2004. Foraging distance and home range of Cassin's Auklets nesting at two colonies in the California Channel Islands. *The Condor* 106 (3): 618-637.
- Anderson, D., J. Charles, G. Carlos, G. Franklin and L. P. Eduardo. 2007. Size of the California Brown Pelican metapopulation during a non-El Niño year. U.S. Geological Survey. Open-File Report 2007-1299. 35.

- Baird, P. H. 1993. Birds. In: Dailey, M., D. Reish, and J. Anderson. Ecology of the Southern California Bight: A synthesis and interpretation. University of California Press, Berkeley.
- California Department of Fish and Game. 2004. California Fish and Game Commission lists Xantus's Murrelet as a Threatened Species. <http://www.dfg.ca.gov/news/news04/04017.html>. 06/08/09.
- California Department of Fish and Game. 2009. State and federally listed endangered and threatened animals of California. <http://www.dfg.ca.gov/biogeodata/cnddb/pdfs/TEAnimals.pdf>. June 2009.
- Crouch, S., C. Paquette and D. Vilas. 2002. Relocation of a large Black-Crowned Night Heron colony in Southern California. *Waterbirds* 25(4):474-478.
- DiGiacomo, P., W. Hamner, P. Hamner and R. Caldeira. 2002. Phalaropes feeding at a coastal front in Santa Monica Bay, California. *Journal of Marine Systems* 37(1-3):199-212.
- Dugan, J. 2006. Utilization of sandy beaches by shorebirds: relationships to population characteristics of macrofauna prey species and beach morphodynamics. U.S. Dept. of the Interior, Minerals Management Service, University of California and Coastal Marine Institute. MMS OCS Study 06-0069.
- Dugan, J., D. Hubbard, D. Martin, J. Engle, D. Richards, G. Davis, K. Lafferty and R. Ambrose. 2000. Macrofauna communities of exposed sandy beaches on the Southern California mainland and Channel Islands. In: Proceedings of the Fifth California Islands Symposium, April 1999, Santa Barbara, CA.
- Hamilton, C.D., H.R. Carter and R.T. Golightly. 2004. Diet of Xantus's Murrelets in the Southern California bight. *Wilson Bulletin* 116(2):152-157.
- Hebshi, A. 1998. Foraging site preferences of Brandt's Cormorants off the Santa Cruz, California, Coast. *Colonial Waterbirds* 21(2):245-250.
- Hubbard, D.M. and J. Dugan. 2003. Shorebird use of an exposed sandy beach in Southern California. *Estuarine, Coastal and Shelf Science* 58:41-54.
- Hui, C.A. and W.N. Beyer. 1998. Sediment ingestion of two sympatric shorebird species. *Science of the Total Environment* 224 (1-3):227-233.
- Hyrenbach, D.K. and R.R. Veit. 2002. Ocean warming and seabird communities of the Southern California Current System (1987-98): Response at multiple temporal scales. *Deep Sea Research Part II: Topical Studies in Oceanography* 50(14-16):2537-2565.
- Ivey, G.L. 2004. Conservation assessment and management plan for breeding Western and Clark's Grebes in California. American Trader Trustee Council, June 2004. 72 pp. + app.

- Jaques, D. and C. Strong. 2003. Brown Pelican Night Roost Sites on the Southern California Coast. California Department of Fish and Game, U.S. Dept. of the Interior, U.S. Fish and Wildlife Service (USFWS) and U.S. Dept. of Commerce, National Oceanic and Atmospheric Administration (NOAA). 20 pp. + app.
- Karnovsky, N. J., L.B. Spear, H.R. Carter, D.G. Ainley, K. D. Amey, L.T. Ballance, K.T. Briggs, R.G. Ford, G.L. Hunt Jr. and C. Keiper. 2005. At-sea distribution, abundance and habitat affinities of Xantus's Murrelets. *Marine Ornithology* 33:89-104.
- Kelly, J., K. Etienne, C. Strong, M. Mccaustland and M. Parkes. 2007. Annotated atlas and implications for the conservation of heron and egret nesting colonies in the San Francisco Bay area. *Waterbirds* 30(4):455-478.
- Marschalek, D. 2006. California Least Tern 2005 breeding season. California Department of Fish and Game. Habitat conservation planning branch, Species conservation and recovery program report 2006-01. 22.
- Mason, J., G. McChesney, W. McIver, H. Carter, J. Takekawa, R. Golightly, J. Ackerman, D. Orthmeyer, W. Perry and J. Yee. 2007. At-sea distribution and abundance of seabirds off Southern California: A 20-Year comparison. *Studies in Avian Biology* 33:1-95.
- Massey, B., D. Bradley and J. Atwood. 1992. Demography of a California least tern colony including effects of the 1982-1983 El Niño. *The Condor* 94(4):976-983.
- Massey, B. and R. Zembal. 1980. A comparative study of the Light-footed Clapper Rail in Anaheim Bay and Upper Newport Bay, Orange County, CA. U.S. Dept. of the Interior, U.S. Fish and Wildlife Service. 69.
- McChesney, G., H.R. Carter and D.L. Whitworth. 1995. Reoccupation and extension of southern breeding limits of tufted puffins and rhinoceros auklets in California. *Colonial Waterbirds* 18:79-90.
- McIver, W. R., H.R. Carter and A.L. Harvey. 2008. Monitoring and restoration of Ashy Storm-Petrels at Santa Cruz Island, California, in 2007. U.S. Dept. of the Interior, U.S. Fish and Wildlife Service. 22.
- Page, G.W. and W.D. Shuford. 2000. Southern Pacific Coast Regional Shorebird Plan. U.S. Shorebird Conservation Plan Version 1.0. March 2000. 60 pp. + app.
- Powell, A.N. 2001. Habitat characteristics and nest success of Snowy Plovers associated with California Least Tern Colonies. *Condor* 103(4):785-792.
- Powell, A.N., C.L. Fritz, B.L. Peterson and J.M. Terp. 2002. Status of breeding and wintering Snowy Plovers in San Diego County, California, 1994–1999. *Journal of Field Ornithology* 73(2):156-165.

- Roth, J., W. Sydeman and P. Martin. 2005. Xantus's Murrelet breeding relative to prey abundance and oceanographic conditions in the Southern California Bight. *Marine Ornithology* 33:115-121.
- Russell, R.W. and P.E. Lehman. 1994. Spring migration of Pacific loons through the Southern California Bight: Nearshore flights, seasonal timing and distribution at sea. *The Condor* 96(2):300-315.
- Schwemm, C.A., J.T. Ackerman, P.L. Martin and W. Perry. 2003. Nest occupancy and hatching success of Xantus's Murrelets (*Synthliboramphus hypoleucus*) breeding on Santa Barbara Island, California, during a twenty-year period. In: Garcelon, D.K. and C.A. Schwemm. *Proceedings of the Sixth California Islands Symposium*. December 2003, Ventura, California.
- Shaffer, S.A., Y. Tremblay, H. Weimerskirch, D. Scott, D.R. Thompson, P.M. Sagar, H. Moller, G.A. Taylor, D.G. Foley and B. A. Block. 2006. Migratory shearwaters integrate oceanic resources across the Pacific Ocean in an endless summer. *Proceedings of the National Academy of Sciences* 103(34):12799.
- Sharpe, P. 2003. Restoration and management of Bald Eagles on Santa Catalina Island, California. *Montrose Settlements Restoration Program*, December 2003. 23.
- Sharpe, P.B., J. Dooley and D. Garcelon. 2004. Bald eagle restoration on the northern Channel Islands, California, May 2002–April 2003. Institute for Wildlife Studies. 1st annual report. Unpublished manuscript on file at park headquarters, Channel Islands National Park, 29.
- Spear, L.B. and D.G. Ainley. 2007. Storm Petrels of the eastern Pacific ocean: Species assembly and diversity along marine habitat gradients. *Ornithological Monographs* 62(1):1-77.
- Strong, C. and D. Jaques. 2003. Brown Pelican roost sites on the mainland coast of Southern California. California Department of Fish and Game, U.S. Dept. of the Interior, U.S. Fish and Wildlife Service (USFWS), and U.S. Dept. of Commerce, National Oceanic and Atmospheric (NOAA). 20 + app.
- Sydeman, W., M. Hester, J. Thayer, F. Gress, P. Martin and J. Buffa. 2001. Climate change, reproductive performance and diet composition of marine birds in the Southern California Current System, 1969-1997. *Progress in Oceanography* 49:309-329.
- Sydeman, W.J., R.W. Bradley, P. Warzybok, C.L. Abraham, J. Jahncke, K.D. Hyrenbach, V. Kousky, J.M. Hipfner and M.D. Ohman. 2006. Planktivorous auklet *Ptychoramphus aleuticus* responses to ocean climate, 2005: Unusual atmospheric blocking. *Geophysical Research Letters* 33.
- U.S. Dept. of the Interior, U.S. Fish and Wildlife Service (USFWS). 2006. California Least Tern (*Sternula antillarum browni*) 5 Year Review Summary and Evaluation. U.S. Dept. of the Interior, U.S. Fish and Wildlife Service (USFWS). 32 pp.

- U.S. Dept. of the Interior, U.S. Fish and Wildlife Service (USFWS). 2007a. Recovery Plan for the Pacific Coast Population of Western Snowy Plover (*Charadrius alexandrinus nivosus*). U.S. Dept. of the Interior, U.S. Fish and Wildlife Service (USFWS). xiv + 751.
- U.S. Dept. of the Interior, U.S. Fish and Wildlife Service (USFWS). 2007b. Listed Distinct Population Segment of the Brown Pelican (*Pelecanus occidentalis*) 5-Year Review: Summary and Evaluation. U.S. Dept. of the Interior, U.S. Fish and Wildlife Service (USFWS). 64 pp.
- Veit, R., P. Pyle and J. McGowan. 1996. Ocean warming and long-term change in pelagic bird abundance within the California Current System. *Marine Ecology Progress Series* 139:11-18.
- Whitworth, D.L., J.Y. Takekawa, H.R. Cater, S.H. Newman, T.W. Keeny and P.R. Kelly. 2000. Distribution of Xantus' Murrelet *Synthliboramphus hypoleucus* at sea in the Southern California Bight, 1995-97. *Ibis* 142(2):268-279.
- Yen, P., W. Sydeman, S. Bograd and K. Hyrenbach. 2006. Spring-time distributions of migratory marine birds in the Southern California Current: Oceanic eddy associations and coastal habitat hotspots over 17 years. *Deep-Sea Research Part II* 53(3-4):399-418.
- Zemba, R., S. Hoffman and J. Konecny. 2007. Status and Distribution of The Light-footed Clapper Rail in California, 2007. U.S. Dept. of the Interior, U.S. Fish and Wildlife Service (USFWS) and California Department of Fish and Game.

10. MARINE MAMMALS

10.1 INTRODUCTION

Marine mammals occurring along the West Coast include cetaceans (including baleen and toothed whales, dolphins, and porpoises); pinnipeds (seals and sea lions); and sea otters. Marine mammal species can be considered Endangered or Threatened under the Endangered Species Act of 1973 (ESA). In the Southern Study Area, there are eight species of baleen whales (suborder Mysticeti); all but gray whales, minke whales and Bryde's whales are listed as endangered species. Twenty species of toothed whales and dolphins (suborder Odontoceti) inhabit the Southern Study Area, only one of which is listed as endangered (sperm whales). This region also includes six pinnipeds and also sea otters, three of which are threatened species (northern sea lions, Guadalupe fur seal and sea otter) ([Table 10.1](#)). The Marine Mammal Protection Act also calls for identifying specific stocks or populations that are below optimum sustainable population levels and designate these as depleted. Furthermore a designation of strategic is applied to any stock that (1) is depleted under the MMPA, (2) is listed or likely to be listed as threatened or endangered under the ESA, or (3) has a level of direct human mortality that exceeds a calculated sustainable potential biological removal rate. These are discussed below on a species by species basis.

Table 10.1.

Marine mammal species for the Southern Study Area

Species	Habitat*	Relative abundance**	Federal status ***
Blue whale	CS, SL, OF	C	EN
Fin whale	CS, SL, OF	C	EN
Humpback whale	CS, SL, OF	C	EN
Sei whale	OF	R	EN
Brydes whale	CS	AC	NL
Minke whale	CS, SL, OF	C	NL
N. Pacific right whale	CS?	UC	EN
Gray whale	CS	C	NL
Sperm whale	OF	C	EN
Pygmy sperm whale	OF	R	NL
Dwarf sperm whale	OF	R	NL
Baird's beaked whale	OF	UC	NL
Cuvier's beaked whale	SL, OF	UC	NL
Hubb's beaked whale	OF	R	NL
Stejneger's beaked whale	OF	R	NL
Killer whales			
- offshore	CS, SL, OF	C	NL
- transients	CS, SL?	C	NL
Pacific white-sided dolphin	CS, SL, OF	C	NL
Northern right-whale dolphin	CS, SL, OF	C	NL
Risso's dolphin	CS, SL, OF	C	NL
Short-beaked common dolphin	CS, SL, OF	C	NL
Long-beaked common dolphin	CS	C	NL
Bottlenose dolphin	CS,SL	C	NL

Striped dolphin	OF	C	NL
Rough-toothed dolphin	CS, OF	AC	NL
Short-finned pilot whale	SL, OF	UC	NL
False killer whale	CS, SL, OF	AC	NL
Harbor porpoise	CS	C	NL
Dall's porpoise	CS, SL, OF	C	NL
Harbor Seal	CS	C	NL
Northern elephant seal	T, CS, SL, OF	UC	NL
California sea lion	T, CS	C	NL
Northern sea lion	CS	AC	TH
Guadalupe fur seal	OF	UC	TH
Northern fur seal	T, OF	UC	NL
Southern Sea otter	CS	UC	TH

*T = Terrestrial haul out in area, CS = continental shelf, SL = continental slope, OF = offshore

**AC = accidental, R = rare, UC = uncommon, C = common.

***EN = Endangered, TH = Threatened, NL = not listed

10.2 SPECIES ACCOUNTS

10.2.1 Blue Whale (*Balaenoptera musculus*)

10.2.1.1 Distribution and Migration

Blue whales were widely distributed in the North Pacific before modern commercial whaling began in the early 1900s. Currently, there appear to be at least two distinct populations of blue whales in the North Pacific, on the basis of differences in the underwater vocalizations between the eastern North Pacific blue whales and those in the central and western North Pacific (Rivers 1997; Stafford et al. 1999; Stafford et al. 2001). Blue whales occupy the waters both on the U.S. Continental Shelf as well as offshore in the eastern North Pacific and range from tropical waters off Central America north to Alaskan waters.

Large concentrations of blue whales have been documented off California, Baja California and the eastern tropical Pacific since the 1970s (Wade and Friedrichsen 1979; Calambokidis et al. 1990; Reilly and Thayer 1990; Barlow 1994; Calambokidis and Barlow 2004; Barlow and Forney 2007). In contrast, the lack of sightings off British Columbia and Alaska, where large numbers were killed during whaling, suggests a lack of recovery for these populations (Rice and Wolman 1982; Stewart 1987; Forney and Brownell 1996). Recent sightings and photo identification of whales off British Columbia and Alaska suggest that whales in these northern waters are part of the same population as those in the south and that a shift in distribution has occurred that may be a return to a migration pattern that occurred historically (Calambokidis et al. 2009).

Currently, blue whales occur throughout the Southern Study Area from late spring through fall. Areas such as the Santa Barbara Channel have some of the highest concentrations known to occur worldwide since whaling for this species was stopped, primarily in the first half of the 20th century (Cascadia Research, unpublished data). Blue whales in the Southern California Bight use coastal areas near shore, shelf edge, and areas hundreds of miles offshore. Blue whales generally migrate in winter to productive areas off Baja California, in the Gulf of California and the Costa Rica Dome in the eastern tropical Pacific (Mate et al. 1999). Systematic surveys

conducted four times a year along the transect lines used for the California Cooperative Oceanic Fisheries Investigations (CALCOFI) surveys off Southern California detected blue whales only in summer and fall (Soldevilla et al. 2006; Douglas et al. In prep). Acoustic detections of blue whales in the Southern California Bight similarly peaked in summer and fall but also detected some calls in winter and spring, indicating some animals are present but in lower numbers (Oleson et al. 2007a; Oleson et al. 2007b).

10.2.1.2 Abundance

The abundance of blue whales has been estimated to be 2,000 to 3,000 for the eastern North Pacific (primarily U.S. West Coast) based on results of line-transect surveys and capture-recapture from photographically identified individuals (Calambokidis and Barlow 2004). The U.S. Stock Assessments use a best estimate of blue whales along the West Coast of 1,368 with a Coefficient of Variation (CV) of 0.22 based on a combination of line-transect and mark-recapture estimates (Carretta et al. 2008). Recent estimates of blue whale abundance off California from line transect surveys have declined (Barlow and Forney 2007; Forney 2007) apparently as a result of an expansion in the feeding area of blue whales and their decreased use of California (Calambokidis et al. 2009). In the Southern Study Area, line-transect estimates from surveys between 1991 and 2005 were 842 (CV = 0.20) blue whales off Southern California south of Point Conception (Barlow and Forney 2007).

Although it would be expected that the eastern North Pacific population of blue whales would have increased since the cessation of whaling in 1966, there is no evidence to show that the population has grown (Carretta et al. 2008). Possible large-scale changes in blue whale distribution observed recently within the eastern North Pacific (Calambokidis et al. 2009) confound efforts to adequately assess trends in abundance.

10.2.1.3 Foraging and Ecological Context

Blue whales feed exclusively on euphausiids (krill). The California coast is one of the most important feeding areas for the eastern North Pacific stock in the summer and fall (Carretta et al. 2008). Blue whales migrate to productive waters in winter, where feeding has also been documented (Calambokidis and Mate, unpublished data). Killer whales are the only known predators of blue whales; rake-mark tooth scars on their bodies are caused by killer whale attacks (Mehta et al. 2007).

10.2.1.4 Status/Threats

Blue whales are listed as endangered under the Endangered Species Act. The eastern North Pacific stock is considered a strategic stock under the Marine Mammal Protection Act of 1972 (MMPA)(Carretta et al. 2008). Ship strikes are a current concern because numerous blue whales have been killed by ships in recent years (Carretta et al. 2008), particularly off Southern California where blue whales feed in the shipping channels (Carretta et al. 2008; Cascadia Research, unpublished data). Off the coast of Washington, ship strikes have become a growing concern, particularly for fin whales; blunt force trauma resembling a ship strike was determined to be the cause of death of two blue whales off Washington in 1980 and 1989 (Douglas et al. 2008). Increasing levels of anthropogenic (human-caused) sound are also thought to be a threat to blue whales worldwide (Reeves 1992; Croll et al. 2001).

10.2.2 Fin Whale (*Balaenoptera physalus*)

10.2.2.1 Distribution and Migration

Fin whales range widely in both coastal and offshore waters of the North Pacific. Little is known about their population structure and migrations; however, there is some evidence of year-round occurrence in some areas, including California waters (Forney et al. 1995; Barlow 1997). For management purposes, NOAA's National Marine Fisheries Service (NMFS) treats the fin whales off the West Coast as a single stock called the California/Oregon/Washington stock (Carretta et al. 2008). Fin whales commonly occur in coastal, slope, and especially offshore areas of the Southern California Bight and are one of the most common baleen whales seen in this area. Concentrations of fin whales have been observed in several areas including near San Nicolas Island, west of San Clemente Island, and near Tanner and Cortez Banks (Cascadia Research, unpublished data). Systematic surveys conducted four times a year along the CalCOFI lines off Southern California have detected fin whales in all seasons, but the highest numbers in summer and fall (Soldevilla et al. 2006; Douglas et al. In prep).

10.2.2.2 Abundance

The best estimate of fin whale abundance for what NMFS considers the California/Oregon/Washington stock is 2,636 (CV = 0.15) (Carretta et al. 2008) based on line-transect surveys conducted in 2001 (Barlow and Forney 2007) and 2005 (Forney 2007). Using data from 1991 to 2005, they estimated the abundance for Southern California (south of Point Conception) as 359 (CV = 0.40). However, they consider these numbers as underestimates because of the difficulty identifying this species at a distance.

10.2.2.3 Foraging and Ecological Context

In the northern hemisphere, fin whales feed primarily on euphausiids, although their diet probably varies by prey availability. They are known to feed on other copepods and small schooling fish (Aguilar 2002; Hewitt and Lipsky 2002). Killer whales are their only known predator (Aguilar 2002).

10.2.2.4 Status/Threats

Fin whales are listed as endangered under the Endangered Species Act. The eastern North Pacific stock is considered a strategic stock under the MMPA (Carretta et al. 2008).

As with blue whales, ship strikes are a current concern affecting mortality in recent years (Carretta et al. 2008). Several ship strikes of fin whales have been noted in the Southern California Bight in recent years, including at least two whales brought into Los Angeles/Long Beach Harbor on the bows of ships. Five fin whales found dead in or near Washington waters in recent years, all an apparent result of ship strikes (Douglas et al. 2008). Such events were rare in this area previously, but in 2002 alone, four fin whale carcasses were recovered in the Washington and Oregon coastal waters, all related to ship strikes. Three dead whales were wrapped around the bows of ships coming into port at Cherry Point and Port of Seattle (WA) and Portland (OR), the fourth animal was found floating in the waters around the San Juan Islands (WA), also dead of apparent ship collision. While it is not known where these animals were

struck, the occurrence of so many incidents in a few months suggested that this species may periodically become more vulnerable when prey concentrations bring fin whales into the shipping lanes.

10.2.3 Sei Whale (*Balaenoptera borealis*)

10.2.3.1 Distribution and Migration

Little is known about sei whales. In the North Pacific, the International Whaling Commission (IWC) considers them as a single stock, although it is possible that those seen offshore are separate from those found in areas closer to the coast (Carretta et al. 2008). Whaling takes showed a continuous distribution of animals within the North Pacific basin between latitudes 45° N and 55° N (Masaki 1977; Carretta et al. 2008). While sei whales were once the fourth most commonly killed species by coastal whalers off California primarily during the 20th century (Rice 1974; Clapham et al. 1997), they are now rare in this region (Dohl 1983; Barlow and Forney 2007; Carretta et al. 2008) (Cascadia Research, unpublished data). Sightings off Southern California and southward are extremely rare (Carretta et al. 2008). In systematic surveys conducted four times a year along the CalCOFI lines off Southern California from 2004 to 2008, no sei whales were seen (Soldevilla et al. 2006; Douglas et al. In prep).

10.2.3.2 Abundance

Few sei whales inhabit the waters of the West Coast. Barlow and Forney (2007) estimated abundance to be under 100 animals (98 whales, CV = 0.57) based on line-transect surveys conducted between 2001 and 2005. In the Southern Study Area, the estimate off the Southern California coast was zero (Barlow and Forney 2007).

10.2.3.3 Foraging and Ecological Context

Horwood (2002) differentiates sei whales from other large rorquals by their feeding behavior: Sei whales tend to feed by skimming along the surface on patches of copepods. This behavior resembles that of right whales. Sei whales also are probably more opportunistic feeders than are blue and fin whales because they also feed on small fish and squid (Hewitt and Lipsky 2002; Horwood 2002). Their only known predator is killer whales (Jefferson et al. 1991).

10.2.3.4 Status/Threats

Sei whales are listed as endangered under the Endangered Species Act. The eastern North Pacific stock is considered a strategic stock under the MMPA (Carretta et al. 2008). Fishery interactions and ship collisions are two concerns for mortality of this species. One sei whale recovered in Washington was killed by a ship strike in 2003 (Douglas et al. 2008).

10.2.4 Bryde's Whale (*Balaenoptera edeni*)

10.2.4.1 Distribution and Migration

Bryde's whales primarily inhabit tropical waters and are common in the eastern Pacific and the Gulf of California; they are considered rare off the coast of California (Leatherwood et al. 1982; Tershy et al. 1990; Barlow and Forney 2007; Carretta et al. 2008). In U.S. waters, the National

Marine Fisheries Service assesses stocks within two regions: the eastern tropical Pacific, including the Gulf of California and California, and the waters off Hawaii (Carretta et al. 2008). There have been several confirmed sightings of Bryde's whale off the coast of Southern California in recent years during the CalCOFI (Douglas et al. In prep). While there is a pattern of migration toward lower latitudes in winter and higher latitudes in summer, little is known about their breeding areas.

10.2.4.2 Abundance

In the eastern tropical Pacific (east of 150° W, between 20° N and 10° S), abundance was estimated at 13,000 (CV = 0.20) by Wade and Gerrodette (1993). Visually, this species is difficult to differentiate from other large baleen whales at a distance; thus sightings were pooled for sei and Bryde's whales and were combined in abundance estimates by Barlow and Forney (2007) and in Southwest Fisheries Science Center surveys between 1991 and 2005. Very few seis were seen off California; the abundance estimate was derived from four sightings and estimated at 18 (CV = 0.65) for sei or Bryde's whales off southern and central California.

10.2.4.3 Foraging and Ecological Context

Bryde's whales feed on pelagic schooling fishes such as anchovy, sardines, and mackerel; they also feed on euphausiids, copepods, cephalopods, and pelagic red crab (Hewitt and Lipsky 2002). Killer whales are a predator of Bryde's whales; one attack was witnessed in the Gulf of California in which 15 killer whales attacked and killed a Bryde's whale (Weller 2002).

10.2.4.4 Status/Threats

Bryde's whales are not listed as endangered under the Endangered Species Act. The eastern North Pacific stock is not considered a strategic stock under the MMPA (Carretta et al. 2008). Fishery interactions and ship collisions are two concerns for mortality of this species.

10.2.5 Humpback Whale (*Megaptera novaeangliae*)

10.2.5.1 Distribution and Migration

Humpback whales range widely in the North Pacific; they migrate seasonally between feeding areas in productive northern waters and warm-water winter breeding and calving areas (Rice 1978). Primary wintering regions in the North Pacific occur off Mexico, Central America, Hawaii, and Asia. Summer feeding areas extend from the coastal waters off Southern California north to the Gulf of Alaska and Bering Sea and west through the Aleutian Islands into the waters off Russia.

Humpback whales show site fidelity to specific feeding areas. There is very limited interchange of individuals among feeding areas, and there are significant differences in the mitochondrial DNA (mtDNA) patterns in whales using different feeding areas (Baker et al. 1990; Baker et al. 1994; Calambokidis et al. 1996). For management purposes, NMFS treats the humpback whales off the West Coast as the California/Oregon/Washington stock. Based on photo-ID matches and genetic studies from the Structure of Populations, Levels of Abundance and Status of Humpbacks (SPLASH) project—a large collaborative effort to examine the status and population

trends of humpback whales throughout the North Pacific (2004-2006)—two separate feeding aggregations inhabit the area: one that ranges between Southern California and Oregon and a separate aggregation feeds off northern Washington and southern British Columbia (Calambokidis et al. 2001; Calambokidis et al. 2004; Calambokidis et al. 2008). Movement data show a low rate of interchange among whales inhabiting these regions, although there is no clear geographic boundary that divides them (Calambokidis et al. 2001; Calambokidis et al. 2004; Calambokidis et al. 2008).

The migratory destinations of the humpback whales that feed along the West Coast are varied. The primary winter grounds for humpback whales off California are the coast of mainland Mexico and Central America (Calambokidis et al. 2000). There were differences in the proportion of whales going to different winter breeding areas based on where they tended to be sighted off California, with whales from Southern California disproportionately going Central America (Calambokidis et al. 2000; Falcone et al. 2005).

Humpback whales off California are generally associated with the Continental Shelf and shelf edge. Systematic surveys conducted four times a year for 2004 to 2008 along the CalCOFI lines off Southern California detected humpback whales in spring, summer, and fall at similar rates (Soldevilla et al. 2006; Douglas et al. In prep).

10.2.5.2 Abundance

Estimates of the abundance of humpback whales off the West Coast have been made both from line-transect surveys and from capture-recapture of individually identified whales (Calambokidis and Barlow 2004; Calambokidis et al. 2004; Barlow and Forney 2007; Forney 2007). The most recent transect survey in 2005 estimated abundance to be 1769 (CV = 0.16) humpback whales for the entire West Coast region. Due to their highly clumped distributions, mark-recapture methods have provided precise estimates of abundance using photo-identification across years (Calambokidis and Barlow 2004). The most recent mark-recapture estimate for the California-Oregon feeding aggregation is 1,648 (CV = 0.11), which is in agreement with the most recent line-transect estimate (Calambokidis et al., unpublished data). Mark-recapture estimates have revealed that humpback whale abundance has increased in this region 7.5 percent per year since the early 1990s. NMFS stock assessments used a weighted mean of earlier line transect and mark-recapture estimates which yielded an estimate of 1,391 (CV = 0.13) (Carretta et al. 2008). Regional abundances of humpback whales were estimated at 36 (CV = 0.51) for Southern California (south of Point Conception) based on surveys from 1991 to 2005 (Barlow and Forney 2007).

The SPLASH project estimated abundances at about 20,000 humpback whales. Overall trends in abundance suggest a 5–6 percent annual increase since the end of whaling in the late 1960s (Calambokidis et al. 2008). A geographically stratified mark-recapture model using recapture between feeding and wintering areas yielded estimates of 1,400–1,700 for California-Oregon, which is in agreement with the regional estimates (Calambokidis et al. 2008).

10.2.5.3 Foraging and Ecological Context

Humpback whales feed on both krill and small fish. Feeding strategies vary by region and year. Whaling data from San Francisco Bay in the 1950s and 1960s showed annual shifts in primary prey between krill (sometimes reported as shrimp) and small fish, such as anchovies, in stomachs of humpback whales taken off central California (Rice 1963).

Killer whales are predators of humpback whales. Humpback whales off California, Oregon, and Washington show some of the highest rates of scarring from killer whale attacks of any feeding area in the North Pacific (Steiger et al. 2008). Killer whales primarily attack calves in their first 6 months of life; most of these attacks probably take place on the wintering grounds. Some juvenile and adult humpback whales also show acquisition of the characteristic rake-mark tooth scars indicating they have survived attacks by killer whales later in life.

10.2.5.4 Status/Threats

The humpback whale is listed as endangered under the ESA. Because of its endangered status, this stock is considered a “strategic” and “depleted” stock under the MMPA. While the population of humpback whales off the West Coast has been recovering, there have also been reports of below normal reproductive rates observed in this population; however, these could be largely the result of bias in the sampling method (Steiger and Calambokidis 2000).

10.2.6 Minke Whale (*Balaenoptera acutorostrata*)

10.2.6.1 Distribution and Migration

Minke whales are the smallest and most abundant worldwide of all the baleen whales. Their size and behavior make them difficult to detect; their blows are indistinct and surfacing profiles are low. Relatively little is known about the population structure and movements of minke whales in the eastern North Pacific. They are thought to be abundant in the Bering and Chukchi seas and the Gulf of Alaska and less abundant in other parts of the eastern North Pacific (Leatherwood et al. 1982; Brueggeman et al. 1990; Green et al. 1992). In the North Pacific, they generally inhabit the waters over continental shelves (Brueggeman et al. 1990).

Minke whales in different areas feed in inland, coastal, and offshore waters. They have been intensely studied in the inland waters of Washington State, especially around the San Juan Islands where they exhibit exclusive home ranges that they return to annually (Dorsey 1983; Hoelzel et al. 1989; Dorsey et al. 1990). In Washington inland waters, minke whales are seen in northern Puget Sound, San Juan Islands, and Gulf Islands (Osborne et al. 1988). While believed to be migratory, the behavior of whales in inland Washington and California suggest that some animals establish at least summer home ranges (Dorsey et al. 1990). Because “resident” whales appear to be behaviorally distinct from the migratory animals off Alaska, minke whales off California, Oregon, and Washington are considered as a separate stock (Carretta et al. 2008).

Systematic surveys conducted four times a year for 2004 to 2008 along the CalCOFI lines off Southern California detected minke whales in spring, summer, and fall but with highest numbers occurring in spring (Soldevilla et al. 2006; Douglas et al. In prep).

10.2.6.2 Abundance

Abundance estimates of minke whales are problematic because the whales are difficult to detect. NMFS stock assessment for California, Oregon, and Washington was 806 (CV = 0.63), based on surveys in 2001 (Barlow and Forney 2007) and 2005 (Forney 2007). Minke whales were not well sampled during these broadscale cruises and densities may have been underestimated because detection probabilities were not estimated directly (Barlow and Forney 2007). Regional abundances were estimated at 226 (CV = 1.02) for Southern California (south of Point Conception) based on surveys from 1991 to 2005 (Barlow and Forney 2007). There are no data on abundance trends for this region.

10.2.6.3 Foraging and Ecological Context

Minke whales in the Antarctic feed mostly on euphausiids, while in other areas they are thought to consume small fish, copepods, and squid (Hewitt and Lipsky 2002). In the San Juan Islands, whales feed on schools of herring and sand lance (Osborne et al. 1988). Killer whales are predators of minke whales. Attacks have been witnessed in the Strait of Juan de Fuca and off British Columbia and southeastern Alaska (Ford et al. 2005a). Minke whales are occasionally caught in coastal and offshore gillnets (Carretta et al. 2008).

10.2.6.4 Status/Threats

Minke whales are not listed under the Endangered Species Act and are not considered depleted or strategic under the MMPA.

10.2.7 North Pacific Right Whale (*Eubalaena japonica*)

10.2.7.1 Distribution and Migration

The North Pacific right whale is one of the most endangered species in the world (Wade et al. 2006). While little is known about their population structure, two stocks are currently recognized: the eastern and western North Pacific stocks (Rosenbaum et al. 2000; Brownell et al. 2001; Angliss and Allen 2008).

Sightings throughout the eastern North Pacific are exceedingly rare; between 1965 and 1999, there were only 82 sightings in the entire eastern North Pacific Ocean, primarily in the Bering Sea and off the Aleutian Islands (Brownell et al. 2001). Illegal whaling by the USSR in the mid-1960s, when 372 right whales were killed in the eastern North Pacific, also has contributed to the paucity of sightings (Doroshenko 2000; Brownell et al. 2001). Just recently there was an encouraging finding: In 2004, a concentration of at least 17 right whales was seen in a survey by Southwest Fisheries Science Center (SWFSC) in the Bering Sea (Wade et al. 2006).

Right whale wintering grounds probably extended from British Columbia to California prior to the decimation of this species by whalers in the early 1900s (Gilmore 1956; Pike and Macaskie 1969; Brownell et al. 2001). Because of the paucity of sightings, there is little information on their current distribution, although 14 of the 15 modern sightings off California and Baja California occurred between February and May (Brownell et al. 2001). In the Southern Study Area, there have been five sightings since 1955, all in the spring: off La Jolla, California in 1955

and 1988 and off the Channel Islands in 1981, 1990, and 1992 (Gilmore 1956; Rice and Fiscus 1968; Woodhouse and Stricklely 1982; Scarff 1991; Carretta et al. 1994; Brownell et al. 2001).

10.2.7.2 Abundance

There is no reliable estimate of northern right whale abundance in the North Pacific. The most recent estimate for the North Pacific was suggested to be in the low hundreds based on a review of sightings (Brownell et al. 2001).

10.2.7.3 Foraging and Ecological Context

The northern right whale diet comprises entirely zooplankton, including copepods, euphausiids, and even pteropods (tiny planktonic snails)(Hewitt and Lipsky 2002; Kenney 2002). Killer whales are their only known predator; although few attacks on right whales have been witnessed (Kraus 1990; Kenney 2002).

10.2.7.4 Status/Threats

Brownell et al. (2001) stated that the prognosis for northern right whales in the eastern North Pacific is poor. Listed as endangered species, right whales are designated as depleted under the MMPA and classified as a strategic stock. This species is one of the most endangered whale populations in the world (Clapham et al. 1999; Brownell et al. 2001).

Entanglements in nets and lines and vessel collisions are a significant source of mortality for right whales in other regions. In the North Atlantic approximately one third of all right whale mortality is caused by humans (Kraus 1990). Entanglement mortality has also occurred in the western North Pacific. Little is known about their vulnerabilities in the eastern North Pacific stock (Brownell et al. 2001; Angliss and Allen 2008). Clapham et al. (2004) suggest that the northern right whales' dependence on a highly specialized food source (copepods) may make this species less adaptable to major environmental shifts.

10.2.8 Gray Whales (*Eschrichtius robustus*)

10.2.8.1 Distribution and Migration

The Eastern Pacific stock of gray whales ranges from its wintering grounds off Baja California, Mexico, to primary feeding grounds in the Bering and Chukchi Seas (Rice and Wolman 1971; Rice et al. 1984). Nearly the entire population migrates along the coastal waters of the West Coast during its winter southbound migration, and again northbound in the spring (Herzing and Mate 1984).

Unlike other whale species, gray whales have a narrow migration route that is quite close to shore, which historically made this species an easier target for whalers. Today, this route also makes them potentially vulnerable to human activity. The southbound migration corridor extends farther offshore compared to the northbound (Pike 1962; Braham 1984). Off the Washington coast, the southbound migration extends out to 40-50 km offshore; during the northbound migration, animals are seen migrating near shore and out to about 20 km offshore (Green et al. 1995).

Outside these migratory periods, summer feeding aggregations of gray whales have been reported to range from central California to southeastern Alaska (Darling 1984; Calambokidis et al. 2002). These animals generally have been referred to as summer or seasonal residents or more recently as the “Pacific Coast Feeding Aggregation” to avoid the misperception that these animals do not migrate (Calambokidis et al. 2002).

In the Southern Study Area, most gray whales migrate past Southern California on route between their breeding grounds in Baja California and their principal feeding grounds in the Bering and Chukchi Seas (Rice and Wolman 1971). The peak of the migration occurs in January during the southbound migration and March during the northbound; cow-calf pairs tend to migrate inshore and are seen between February and May (Rice and Wolman 1971; Leatherwood 1974). Migrating whales travel a variety of routes through the Southern Study Area, and sightings are distributed both along the coast but most animals travel the route outside the Channel Islands (Leatherwood 1974).

10.2.8.2 Abundance

Aboriginal whalers hunted gray whales sustainably for hundreds of years (Henderson 1984). The eastern North Pacific gray whale population was estimated at between 15,000 and 25,000 animals for the early 19th century prior to commercial whaling (Henderson 1984). Between 1850 and 1880, the entire stock was nearly hunted to extinction by Yankee whalers; the remaining population probably numbered between a few hundred to 2,000 animals (Henderson 1984).

The most recent estimate of the overall abundance of Eastern North Pacific gray whale was just over 18,000 animals in 2001–2002 (18,178, CV = 0.098, 95 percent log-normal confidence interval = 15,010 to 22,015)(Rugh et al. 2005). This was a substantial decrease from estimates of almost 30,000 whales in 1997–1998 using the same census methods (Rugh et al. 2005). While the 1997–1998 estimate may have been biased upward, there appeared to have been a real decline in abundance because of high mortality and low reproduction in 1999 and 2000 (Gulland et al. 2005). This mortality is likely the result of this population reaching carrying capacity (Rugh et al. 2005); this trend appears to have been short-term and is not believed to be continuing presently (Angliss and Allen 2008).

From Northern California to southeastern Alaska, about 200 to 260 whales feed each summer. Between 1996 and 1998, Calambokidis et al. (2002) estimated that there were 179 (CV = 0.09) and 181 (CV = 0.10) whales (two estimates based on Petersen capture-recapture estimates for different pairs of years for 1996 to 1998) in summer months. Most recent capture-recapture models estimate about 250 whales between Northern California to southeastern Alaska (Calambokidis et al., in prep.).

10.2.8.3 Foraging and Ecological Context

The gray whale is the only baleen whale that regularly depends on benthic organisms for prey. They employ various methods for feeding, but most consistently use suction to consume organisms that reside in the substrate. Gray whales feed primarily on organisms along the bottom throughout their range (Murison et al. 1984; Nerini 1984; Oliver and Slattery 1985; Weitkamp et al. 1992). A wide variety of prey has been documented for gray whales, although the majority of the

population feeds on ampeliscid amphipods in the Bering Sea (Nerini 1984). Killer whales are their only known natural predator (Jefferson et al. 1991).

10.2.8.4 Status/Threats

The ESA lists the Eastern North Pacific stock of gray whales as endangered. That designation was retained until 1994, when NMFS and the U.S. Fish and Wildlife Service determined that the stock should be delisted due to an increase in population size following several years of regulatory protection. Currently, Federal protection of this species is maintained under the Marine Mammal Protection Act, which prohibits the take of gray whales (capture or harassment), yet provides for limited harvest under certain circumstances, such as where preexisting treaty rights of Native American tribes (e.g., Makah tribal subsistence hunting rights) apply.

Gray whales have long been an important ceremonial and subsistence resource for several of the Northwest tribes, including the Makah, Quileute, Quinault, Hoh, and Klallam. In 1995, the Makah proposed resumption of their aboriginal hunt of gray whales primarily for cultural purposes. Since 1999, they have killed two animals amid much controversy. The hunt is currently suspended due to legal challenges.

Other causes of gray whale death included ship strikes, entanglement, and killer whale attacks (Sumich and Harvey 1986; Heyning and Dahlheim 1990; Baird et al. 2002; Douglas et al. 2008). While ship strikes do occur, there appears to be a lower incidence than with other large whale species (Douglas et al. 2008). An unusual mortality event occurred along the West Coast of North America in 1999 and 2000, when over 651 dead gray whales were recovered (compared to an annual mean of 41 animals); while starvation appeared to be the primary cause of death, the underlying cause was unclear (Gulland et al. 2005).

10.2.9 Sperm Whales (*Physeter macrocephalus*)

10.2.9.1 Distribution and Migration

Sperm whales are a deepwater species that inhabit the waters off the U.S. Continental Shelf and in deepwater canyons (Whitehead 2002). While they are widely distributed in the North Pacific, relatively little is known about their distribution, movements, and population structure. For management purposes, the IWC has divided sperm whales in the North Pacific into two management regions; however, this boundary has not been reviewed in recent years (Donovan 1991). The NMFS has divided sperm whale stocks into three discrete units: (1) California, Oregon, and Washington waters, (2) waters off Hawaii, and (3) Alaskan waters (Carretta et al. 2008). While there is some genetic evidence of stock segregation between nearshore and offshore animals within the North Pacific (Mesnick et al. 1999), a study to examine sperm whale stock differentiation found that whales were evenly distributed in the temperate North Pacific between California and offshore to Hawaii (Barlow and Taylor 2005).

The summer range for sperm whales includes all of the North Pacific and southern Bering Sea; in winter they are thought to occur south of 40° N (Rice 1974; Gosho et al. 1984; Carretta et al. 2008). Off California, Oregon and Washington, sperm whales are generally found year-round

(Dohl 1983; Green et al. 1992; Barlow 1995; Forney et al. 1995; Carretta et al. 2008). Discovery tags attached to sperm whales off Southern California in winter from 1962 to 1970 were later retrieved in whales killed off Northern California (June), Washington (June), and British Columbia (April) (Rice 1974).

Systematic surveys conducted four times a year for 2004 to 2008 along the CalCOFI lines off Southern California detected sperm whales in deeper waters in all seasons (Soldevilla et al. 2006; Douglas et al. In prep).

10.2.9.2 Abundance

While large numbers of sperm whales inhabit the North Pacific, population estimates are temporally variable (Barlow and Forney 2007). Because they tend to congregate in large groups, there is more variability in abundance estimates (Barlow and Forney 2007). Several estimates have been made for the region off California, Oregon, and Washington and out 300 nmi: 1,407 (CV = 0.39) during summer/fall 1993 and 1996 (Barlow and Taylor 2001); 2,593 (CV = 0.30) in 2001; and 3,140 (CV = 0.40) in 2005 (Barlow and Forney 2007; Forney 2007; Carretta et al. 2008). Barlow and Forney (2007) speculate that the increased trends in abundance may be a result of the availability of giant squid in the region. In the Southern Study Area, regional abundance was estimated at 607 (CV = 0.57) for Southern California, south of Point Conception (Barlow and Forney 2007).

10.2.9.3 Foraging and Ecological Context

Sperm whales prey on deepwater organisms, including numerous mesopelagic species of squid as well as noncephalopod prey, including fish (Whitehead 2002). Killer whales are their only known natural predator; Pitman et al. (2001) document several witnessed killer whale attacks of sperm whales off the coast of Mexico and California.

10.2.9.4 Status/Threats

Sperm whales are considered Endangered under the Endangered Species Act, and therefore considered a strategic stock under the MMPA. Some sperm whales have been entangled and killed in fishing nets associated with the drift gillnet fishery off California (Carretta et al. 2008). Douglas et al. (2008) reported propeller wounds on a dead sperm whale off Washington State, but there is no other evidence that ship strikes are a concern (Carretta et al. 2008). Increasing levels of anthropogenic sound is a concern for most whale species, particularly the “deep-diving whales like sperm whales that feed in the ocean’s sound channel” (Carretta et al. 2008).

10.2.10 *Kogia* spp: Dwarf Sperm Whales (*Kogia sima*) and Pygmy Sperm Whales (*Kogia breviceps*)

10.2.10.1 Distribution and Migration

Both dwarf sperm whales and pygmy sperm whales inhabit deepwater canyons and the waters just off the U.S. Continental Shelf (Ross 1984; Caldwell and Caldwell 1989; Carretta et al. 2008). Both species are difficult to sight and differentiate at sea. There were only nine sightings of *Kogia* spp. in surveys conducted between 1991 and 2005, but it is unclear whether they were

dwarf or pygmy sperm whales (Carretta et al. 2008). Most of the information about their presence comes from the strandings. These occurrences are not uncommon for pygmy sperm whales off the coasts of California, Oregon, and Washington. Strandings of dwarf sperm whales are rare; five had been reported off California between 1967 and 2000 (in Carretta et al. 2008). It is possible that the low number of strandings may reflect the pelagic distribution of this species and not necessarily be an indication of abundance (Carretta et al. 2008).

There are no data to examine movements, seasonality, or stock discreteness. NMFS divides these animals into two stocks: those off California, Oregon, and Washington, and those off Hawaii (Carretta et al. 2008).

10.2.10.2 Abundance

Due to the difficulty of identifying or differentiating dwarf sperm whales and pygmy sperm whales at sea, abundance estimates are made for both species combined. For the West Coast, Barlow and Forney (2007) estimated 1,237 (CV = 0.45) animals. In the Southern Study Area, no animals (*Kogia* spp.) were estimated south of Point Conception; 710 (CV = 0.58) animals were estimated off central California (Point Conception to Point Reyes). Confidences are less precise because of the low sightability of these species.

10.2.10.3 Foraging and Ecological Context

Like sperm whales, these two deep-diving species tends to eat squid and also some fish, small sharks, and octopods (Perrin et al. 2002).

10.2.10.4 Status/Threats

Dwarf sperm whales and pygmy sperm whales are not considered endangered under the ESA. Because they are believed to be rare off the West Coast, and there is no history of fisheries interactions, they are not classified as a strategic stock under the Marine Mammal Protection Act (Carretta et al. 2008). Increasing levels of anthropogenic sound are a concern for these deep-diving species, particularly the impacts of active sonar that has been implicated in the strandings of beaked whales (Frantzis 1998; Balcomb and Claridge 2001; Taylor et al. 2004; Cox et al. 2006).

10.2.11 Beaked Whales

10.2.11.1 Distribution and Migration

Beaked whales are among the least understood of all marine mammal species (Cox et al. 2006). There are several species of open-ocean, toothed whales that are probably always found in the offshore waters of the West Coast, including Southern California, primarily in small numbers, although they are rarely seen due to their preference for open-ocean habitats, long dive times, sometimes cryptic surfacing behavior, and occasional avoidance of boats. There are four species of beaked whales: Baird's beaked whale (*Berardius bairdii*); Cuvier's beaked whale (*Ziphius cavirostris*); Stejneger's beaked whale (*Mesoplodon stejnegeri*); and Hubbs beaked whale (*Mesoplodon carlhubbsi*). These species have been documented from both stranding records and some sightings (Carretta et al. 2008), although the *Mesoplodon* are generally not distinguishable

at sea. Other *Mesoplodon* species that could inhabit the waters off the East Coast include the Blainville's beak whale (*M. densirostris*), Perrin's beaked whale (*M. perrini*), lesser beaked whale (*M. peruvianus*), and the ginkgo-toothed beaked whale (*M. ginkgodens*), although these four species tend to inhabit more warm-temperate and tropical waters (Pitman 2002).

Along the West Coast, Baird's beaked whales are generally found along the continental slope from late spring to early fall; fewer animals are seen farther offshore during winter and early spring (Carretta et al. 2008). Cuvier's beaked whales are encountered more often along the West Coast than are other beaked whale species. There is no evidence of seasonal differences in distribution for the Cuvier's beaked whale or any of the *Mesoplodon* species.

The NMFS treats the West Coast beaked whales as separate stocks from those in other regions (Carretta et al. 2008). Because of the difficulty in distinguishing the different species, the *Mesoplodon* species are treated as one management unit.

10.2.11.2 Abundance

The West Coast abundance estimate for Baird's beaked whales is 1,005 (CV = 0.37); for Cuvier's beaked whales, 4,342 (CV = 0.58); and all species of *Mesoplodon* is 1,177 (CV = 0.40) (which likely includes three additional species as well as Stejneger's and Hubbs)(Barlow and Forney 2007; Carretta et al. 2008). In the Southern Study Area, estimates for Southern California (south of Point Conception) for Baird's beaked whales are 127 (CV = 1.14); for Cuvier's beaked whales, 911 (CV = 0.68); and for the *Mesoplodon* spp.: 132 (CV = 0.96) (Barlow and Forney 2007). There are no data on trends on abundance for any of these species.

10.2.11.3 Foraging and Ecological Context

Most beaked whales prey on deepwater fishes and squid, feeding at depth of 200 m or more (Heyning 2002; Kasuya 2002; Pitman 2002). Although killer whales are thought to be a likely predator of these species, there have been few records of observed attacks (Jefferson et al. 1991; Pitman 2002; Weller 2002).

10.2.11.4 Status/Threats

None of the beaked whale species is listed as threatened or endangered. Naval exercises in a number of regions have been implicated as the cause of beaked whale mass stranding in a number of regions, including off Greece, the Bahamas, Madeira Islands, Canary Islands, and Gulf of California (Balcomb and Claridge 2001; Jepson et al. 2003; Brownell et al. 2004; Barlow et al. 2006; Cox et al. 2006; Macleod and D'amico 2006).

10.2.12 Killer Whale (*Orcinus orca*)

10.2.12.1 Distribution and Migration

Although killer whales are found in all oceans and seas of the world, their density is greatest in colder waters within 800 km of major continents (Forney and Wade 2006). Off the West Coast of North America they are found in relatively high density in nearshore waters from Alaska to California (Forney and Wade 2006).

Despite their broad distribution, there is extensive evidence of population subdivision of killer whales in the coastal temperate waters of the eastern North Pacific. Populations in this area can be broadly subdivided into fish-eating and mammal-eating forms or ecotypes, colloquially termed “resident” and “transient,” respectively, although these designators are known to be misleading in terms of movement patterns. These fish-eating (resident) and mammal-eating (transient) populations are genetically and morphologically distinct (Bigg et al. 1987; Baird and Stacey 1988; Stevens et al. 1989; Hoelzel et al. 2002), and differ in habitat use, vocalizations, social organization, and other aspects of behavior (Morton 1990; Ford et al. 1998; Baird and Whitehead 2000). The fish-eating and mammal-eating whales do not associate with each other and may actively avoid one another (Baird and Dill 1995). Fish-eating killer whales are further subdivided into at least two, and most likely three, populations off the West Coast, colloquially termed “northern residents,” “southern residents,” and “offshores.” Individuals from these populations have not been known to associate, and they differ in terms of acoustics, mitochondrial DNA, and core home ranges (Ford et al. 1998; Hoelzel et al. 2002). The so-called offshore population is not known to inhabit truly pelagic waters, but is generally found on the continental shelf. This population is closely genetically related (by mitochondrial DNA) to the fish-eating form (Hoelzel et al. 2002) and is known to eat fish (Jones 2006). The offshore population has been considered by some to be a third population of the fish-eating ecotype (Baird 2001) and has been noted by others as a third ecotype (Jones 2006), although no comprehensive assessment of differences in behavior and genetics has been made.

All three populations of fish-eating killer whales overlap in their ranges, although there are differences in the core areas the whales use, at least in summer months when most monitoring of movements has taken place. While the core summer range of the northern resident population is centered in inshore central British Columbia (Johnstone Strait and surrounding areas), this population ranges at least as far south as the Washington-Oregon border and north to southeast Alaska. The core summer range of the southern resident population straddles the Washington-British Columbia border in inland waters, though this stock ranges as far north as northern British Columbia and as far south as central California, at least in winter. The offshore extent of both populations is unknown. The offshore population ranges from Southern California north to the Aleutians. Whales from this population are seen only infrequently in inshore waters (e.g., around the San Juan Islands), and they are thought to primarily inhabit shelf and possibly slope waters, though the offshore extent of the range is unknown.

Only a single population of mammal-eating killer whales is known to use Washington waters, referred to as the “West Coast Transient” population by NMFS (other populations of mammal-eating killer whales exist in Alaskan waters). The range of mammal-eating killer whales overlaps with all three populations of fish-eating killer whales, though their spatial and temporal use of shared waters differs (Heimlich-Boran 1988; Morton 1990; Baird and Dill 1995). The overall range of the population is in near shore waters from Southern California to southeast Alaska, with nothing known of the offshore extent of the range. Some individual mammal-eating killer whales have been documented with an overall range of 140,000 km² (Calambokidis and Baird 1994), and movements of individuals between California and Alaska have been documented (Black et al. 1997). Despite such movements, there appears to be some preferential

area use by mammal-eating killer whales throughout their range. Killer whales individually identified off California have been resighted as far north as British Columbia and Glacier Bay, Alaska and as far south as San Benitos Islands, Mexico (Black et al. 1993). Identified animals off Southern California include members of both the transient or mammal-eating and offshore types of killer whales.

10.2.12.2 Abundance

Population sizes for northern and southern residents has been estimated based on direct counts of individually identifiable animals (see Bigg et al. 1987; Ford et al. 2000). In 2005 the southern resident population was known to have 91 individuals, while in 2004 the northern resident population was known to have approximately 219 individuals (Ford et al. 2005b). Population sizes of offshore and mammal-eating killer whales are not known with any precision. Direct counts of identifiable individuals for those populations are problematic because there are long time periods between resightings and it is not possible to assess whether individuals have died. The National Marine Fisheries Service estimates population size for the offshore population based on identified individuals (Ford et al. 2000; Ford et al. 2005b) at 211 individuals (Carretta et al. 2008), which is considered an underestimate because not all whales have been identified (Carretta et al. 2008). For the entire California/Oregon/Washington coast, a total of 1,014 (CV = 0.29) killer whales were estimated from line-transect surveys between 2001 and 2005, although this estimate does not distinguish among the different stocks (Barlow and Forney 2007).

In the Southern Study Area, ship line-transect estimated abundance at 30 (CV = 0.73) whales off Southern California from surveys between 1991 and 2005 (Barlow and Forney 2007).

10.2.12.3 Foraging and Ecological Context

Prey of killer whales includes a wide variety of fish, cephalopods, pinnipeds, and other cetaceans, as well as other prey such as birds, deer, and sea turtles (see reviews by Perrin 1982; Hoyt 1984; Jefferson et al. 1991). In some areas, different forms of killer whales show very different prey preferences and feeding behavior (Bigg et al. 1987). Fish prey range from small schooling fishes, including herring and sardines, to large fish such as halibut and basking sharks (Hoyt 1984). Documented predation on marine mammals by killer whales has been observed for 20 species of cetaceans, 14 species of pinniped, sea otter, and dugong (Jefferson et al. 1991). These whales feed primarily on harbor seals, though they occasionally take Dall's porpoise, harbor porpoise, California sea lions, Steller sea lions, and northern elephant seals (Baird and Dill 1995).

10.2.12.4 Status/Threats

The southern resident stock of killer whales was listed as endangered under the ESA in 2006. Neither the transient nor the offshore populations that are seen off Southern California are listed in U.S. waters under the ESA, nor are they listed as depleted under the MMPA.

10.2.13 Common Dolphin-Short-Beaked and Long-Beaked (*Delphinus delphus* and *D. capensis*)

10.2.13.1 Distribution and Migration

These two forms were previously considered one species and have only fairly recently been recognized as separate species (Heyning and Perrin 1994; Rosel et al. 1994). Long-beaked dolphins were formerly known as the Baja neritic form of common dolphin reflecting its primary distribution in nearshore waters (less than 50 nmi offshore) off Baja California (including the Gulf of California) and north into central California.

Short-beaked common dolphins are the most abundant cetacean in California waters; they are widely distributed out to at least 300 nmi (Carretta et al. 2008). Historically they were reported primarily south of Point Conception (Dohl et al. 1986), but since the 1990s have been commonly seen off central and Northern California and occasionally farther north (Barlow and Forney 2007). Short-beaked common dolphin distribution is continuous southward through Mexico into the eastern tropical Pacific down to about 13° N, but they are managed as several stocks of which the portion in California may be a northern extension of the “northern common dolphin stock,” as defined for management (Carretta et al. 2008).

10.2.13.2 Abundance

Estimates of abundance off California for long-beaked common dolphins have been fairly disparate, in part as a result of both their small clumped distribution in U.S. waters and also the seasonal/annual fluctuations in the portion of the population in U.S. waters. Estimates of long-beaked dolphins in U.S. waters have included 20,076 from surveys in 2001 (Barlow and Forney 2007), and 11,714 from surveys in 2005 (Forney 2007). NMFS stock assessments use a geometric mean of the 2001 and 2005 surveys, 15,335 (CV = 0.56)(Carretta et al. 2008). Most of the estimates of the abundance in U.S. waters of long-beaked common dolphins is for the Southern California Bight; based on survey results from 1991 to 2005, 17,530 were estimated for Southern California (south of Point Conception) and 4,375 were estimated for central California (north of Point Conception) (Barlow and Forney 2007).

Short-beaked common dolphins have consistently been the most abundant marine mammal in California waters. Estimates of short-beaked dolphins in U.S. waters were 517,335 (CV=0.41) from surveys in 2001 and 459,615 from surveys in 2005, with the NMFS stock assessment based on the geometric mean of 487,622 (CV = 0.26) (Forney 2007). Estimate of the abundance of short-beaked common dolphins by region within U.S. waters yielded an estimate of 178,023 (CV = 0.36) for Southern California (south of Point Conception) based on surveys in 2005 (Forney 2007).

10.2.13.3 Foraging and Ecological Context

Long-beaked common dolphins primarily inhabit coastal near shore waters. They travel in large schools and are very commonly encountered in coastal waters of the Southern California Bight, especially in and around the Santa Barbara Channel. While the distribution of short-beaked common dolphins tends to be farther offshore than the long-beaked common dolphin, short-beaked can also occur in coastal near shore waters. Prey for both species consists largely of

small schooling fish and squid. Off Southern California, prey may vary seasonally and includes anchovies, squid, and smelt. Common dolphins have been documented as prey of killer whales (Weller 2002).

10.2.13.4 Status/Threats

These two species are some of the most abundant small cetaceans off Southern California; neither species is listed under the ESA nor considered depleted or strategic under the MMPA.

10.2.14 Bottlenose Dolphin (*Tursiops truncatus*)

10.2.14.1 Distribution and Migration

Bottlenose dolphins are widely distributed in coastal and offshore tropical and temperate waters worldwide. Off California and in many other regions, separate populations occur in coastal and offshore waters (Carretta et al. 2008) and these are distinguishable by nuclear and mitochondrial DNA (Lowther 2006). For management purposes, NMFS designates two stocks, a California coastal stock of bottlenose dolphins and a California/Oregon/Washington offshore stock, although individuals from both these populations range southward into Mexico (Carretta et al. 2008).

Coastal bottlenose dolphins are typically found within 500 m of shore and range from tropical waters north into central California, while offshore bottlenose dolphins are distributed in waters farther offshore and appear to range north to about 41° N (Carretta et al. 2008). On the basis of photographic identification, coastal bottlenose dolphins appear to be highly mobile within the narrow coastal corridor, with high resighting rates among regions within Southern California and northern Mexico (Defran et al. 1999). An expansion of the range of coastal bottlenose dolphins appeared to occur after 1983 when sightings to Monterey Bay became common (Wells et al. 1990).

10.2.14.2 Abundance

Abundance of the coastal bottlenose dolphin stock has been estimated primarily from photographic identification based on distinguishing marks on the dorsal fin. Only about 65 percent of the dolphins have distinguishing marks. The most recent estimates of this component of the population based on mark-recapture was 323 (CV = 0.13) (Dudzic et al. 2006). Adjusting for unmarked animals results in an abundance closer to 450-500, although not all of these animals would be in U.S. waters all the time (Carretta et al. 2008). The population appears to be relatively stable based on a comparison to estimates in the 1980s (Defran and Weller 1999).

Best estimates of the offshore bottlenose dolphin stock come from ship line-transect surveys, which estimated 4,666 in 2001 and 2,273 in 2005 (Forney 2007). Most of these are from sightings in Southern California (south of Point Conception), with estimates for this region being 1,831 (CV = 0.47) from surveys from 1991 to 2005 (Barlow and Forney 2007) or 2,011 (CV = 0.62) based on surveys from just 2005 (Forney 2007). NMFS stock assessments use a geometric mean of the estimates from 2001 and 2005, of 3,257 (CV = 0.43) for the estimate of the population off this stock in U.S. waters (Carretta et al. 2008).

10.2.14.3 Foraging and Ecological Context

Bottlenose dolphins occur widely in temperate and tropical waters and, although they feed on a wide variety of fish and squid, they appear to specialize within specific areas. The prey of coastal bottlenose dolphins in Southern California consists of a number of fish and invertebrates (Walker 1981). Primary fish prey was croakers (family Sciaenidae), including queenfish and white croaker, and surfperches (family Embiotocidae), including walleye and white surfperch (Walker 1981). The croakers and surfperches as well as other prey are species that primarily inhabit coastal inshore marine and estuarine waters. Bottlenose dolphins have been documented as prey of killer whales (Weller 2002).

10.2.14.4 Status/Threats

This species is not listed under the ESA or considered depleted or strategic under the MMPA. It only rarely interacts with fisheries. High levels of contaminants have been documented in these mammals, especially in coastal bottlenose dolphins. The concentrations of DDTs found in bottlenose dolphins from the Southern California Bight (SCB) are among the highest reported for any marine mammal (O'shea et al. 1980; Wagemann and Muir 1984). The principal prey of coastal bottlenose dolphins are some of the most contaminated marine organisms in the SCB (Pollock et al. 1991).

10.2.15 Offshore Delphinids

10.2.15.1 Distribution and Migration

Three other species of toothed whales are relatively abundant and are found off the West Coast year-round: Pacific white-sided dolphins (*Lagenorhynchus obliquidens*), northern right whale dolphins (*Lissodelphins borealis*), and Risso's dolphins (*Grampus griseus*). Pacific white-sided dolphins and northern right whale dolphins are endemic to the temperate waters of the North Pacific, while Risso's dolphins are found worldwide in tropical and temperate waters. All three species are found on the continental slope and shelf, as well as offshore. However, along the West Coast, Pacific white-sided dolphins seem to be seen primarily in shelf and slope waters, while the other two species are also regularly seen in offshore waters (Leatherwood et al. 1982; Carretta et al. 2008). Seasonal north-south movements have been suggested for all three species (Carretta et al. 2008). The NMFS manages these species as one stock for Washington, Oregon, and California region (Carretta et al. 2008). For Pacific white-sided dolphins, there appear to be at least two forms in the eastern Pacific, a northern and a southern form, with an overlap zone around 32°–37°N (Walker et al. 1984; Walker et al. 1986). For northern right whale dolphins, Dohl (1983) suggested that there might be separate populations off central and Northern California on the basis of on a gap in sightings between these two areas of concentration. For Risso's dolphins, there are several gaps in the north-south distribution of animals and also evidence of seasonal movements (Kruse 1989). These species often associate in mixed groups (Lipsky 2002).

In the Southern Study Area, Pacific white-sided dolphins and northern right whale dolphins generally have been sighted in more offshore waters, especially around the western side of the Northern Channel Islands. Northern right whale dolphin occurrence was reported as seasonal, with

no sightings made during systematic surveys from 1975 to 1978 occurring during the warm-water months of July through October (Dohl et al. 1981). Animals entering the Southern Study Area in winter and spring may represent animals that moved from more offshore waters (Dohl et al. 1981). The distribution of Risso's dolphin in the Southern Study Area is similar to the other two species, with most sightings offshore. Risso's and Pacific white-sided dolphins were both sighted in all seasons during systematic surveys conducted four times a year for 2004 to 2008 along the CalCOFI lines off Southern California (Soldevilla et al. 2006; Douglas et al. In prep).

10.2.15.2 Abundance

Population estimates for the waters of California, Oregon, and Washington are 23,817 (CV = 0.36) for Pacific white-sided dolphins; 11,097 (CV = 0.26) for northern right whale dolphins; and 11,910 (CV = 0.24) for Risso's dolphins (Barlow and Forney 2007; Carretta et al. 2008). Off Southern California, abundances were estimated at 2,196 (CV = 0.71) for Pacific white-sided dolphins; 1,172 (CV = 0.52) for northern right whale dolphins; and 3,418 (CV = 0.31) for Risso's dolphins (Barlow and Forney 2007).

10.2.15.3 Foraging and Ecological Context

Pacific white-sided dolphins prey on lantern fishes, anchovies, Pacific saury, Pacific hake, deep sea smelt, argentines, and squid off California (Fiscus and Niggol 1965; Fitch and Brownell 1968; Stroud et al. 1981; Walker and Jones 1993; Waerebeek and Wursig 2002) and herring, salmon, cod, shrimp, and capelin off British Columbia (Heise 1997). Northern right whale dolphins tend to feed on squid, as well as lanternfish, Pacific hake, deep-sea smelt, argentines, and Pacific saury (Fitch and Brownell 1968; Leatherwood et al. 1982; Walker and Jones 1993; Lipsky 2002). Risso's dolphins feed almost entirely on squid, most likely at night (Leatherwood et al. 1982; Baird 2002).

10.2.15.4 Status/Threats

None of these species is listed under the ESA and none of these stocks is considered depleted or strategic under the MMPA.

10.2.16 Other Tropical Delphinids in the Southern California Bight

10.2.16.1 Distribution and Migration

Other tropical delphinids that at least occasionally have been documented in the Southern Study Area include striped dolphins (*Stenella coeruleoalba*) and short-finned pilot whales (*Globicephala macrorhynchus*). Rough-toothed dolphins (*Steno bredanensis*) and false killer whales (*Pseudorca crassidens*) occur south of this region but are present on rare occasions (Carretta et al. 2008). All of these species are typically found only in warm-temperate and tropical areas in deep offshore waters of the eastern North Pacific. Striped dolphins are common to Southern California and found within 100-300 nmi offshore; they appear to have a continuous distribution in the offshore waters off California and Mexico (Perrin et al. 1985; Carretta et al. 2008). Short-fin pilot whales were common off Southern California until an El Niño event in 1982-1983, afterwards this species disappeared from the region entirely (Barlow 1997; Carretta

et al. 2008). Small numbers of them have been seen since 1993, but sightings remain rare (Barlow and Forney 2007; Carretta et al. 2008).

10.2.16.2 Abundance

For the West Coast, Barlow and Forney (2007) estimated abundances for striped dolphins (18,976, CV = 0.28) and for the short-finned pilot whale (350, CV = 0.48). For Southern California, estimates were 12,529 (CV = 0.28) for striped dolphins and 118 (CV = 1.04) for short-finned pilot whales (Barlow and Forney 2007). The winter population of short-finned pilot whales off Southern California in the 1970s was estimated at up to 2,000 animals (Dohl et al. 1981).

10.2.16.3 Foraging and Ecological Context

These species all prey on a wide variety pelagic fishes and squid (Norris and Prescott 1961; Seagers and Henderson 1985; Shane and Mcsweeney 1990; Baird 2002; Leduc 2002; Olson and Reilly 2002); preferences vary by season and region (Perrin et al. 2002). False killer whales have also been known to prey on smaller pelagic dolphins and, in one case, a humpback whale calf (Baird 2002; Balance 2002; Weller 2002). All of these species are potential prey of killer whales and possibly sharks (Balance 2002).

10.2.16.4 Status/Threats

None of these species is listed as threatened or endangered under the ESA or as depleted under the MMPA, except the short-finned pilot whale, which is classified as a strategic stock due to incidental entanglements (Carretta et al. 2008). An increased number of short-finned pilot whales were taken in drift gillnets off California since their return to this region (Julian and Beeson 1998; Carretta et al. 2008).

10.2.17 Dall's Porpoise (*Phocoenoides dalli*)

10.2.17.1 Distribution and Migration

Dall's porpoises are commonly found in shelf, slope, and offshore temperate waters off the West Coast of North America. For management purposes the NMFS considers them a single U.S. stock along the entire coast of Washington through California, although it is possible that more than one stock exists. Densities drop off in Southern California and they may only be there seasonally. Systematic surveys conducted four times a year for 2004 to 2008 along the CalCOFI lines off Southern California detected Dall's porpoise primarily in winter and spring (46 sightings) and only at a low rate in summer and fall (3 sightings) (Soldevilla et al. 2006; Douglas et al. In prep).

10.2.17.2 Abundance

Estimates of abundance exist both for inland Washington waters and for the outer coast of Washington, Oregon, and California. Ship transect abundance estimates are difficult for this species due to their attraction to vessels (Turnock and Quinn 1991); however, surveys by Barlow and Forney (2007) minimized this bias considering behavior in their estimates. Off California, Oregon, and Washington, estimates were 85,955 (CV = 0.45) for ship surveys between 1991 and

2005 (Barlow and Forney 2007). The NMFS stock assessment reports use a mean of the estimates from the 2001 and 2005 surveys of 48,376 (CV = 0.24)(Carretta et al. 2008). Regional estimates for Southern California (south of Point Conception) were much lower; they were estimated at 727 using data from 1991 to 2005 (Barlow and Forney 2007) and 2,861 from 2005 data only (Forney 2007). All these estimates were based on surveys in the summer and fall which likely underestimates the abundance of these animals present in winter and spring.

10.2.17.3 Foraging and Ecological Context

The diet of Dall's porpoise in Washington waters consists primarily of diverse small fish, although cephalopods and a small number of crustaceans and polychaetes have also been documented (Walker et al. 1998). There is considerable overlap in diet with the harbor porpoise (Walker et al. 1998) in inland waters. Dall's porpoises regularly hybridize with harbor porpoises in inland waters (Baird et al. 1998; Willis et al. 2004), although there are differences in habitat use in areas where they overlap (Baird and Guenther 1995). Dall's porpoise have been documented as prey of killer whales (Jefferson et al. 1991; Weller 2002).

10.2.17.4 Status/Threats

The California/Oregon/Washington stock of this species has not been listed under the ESA and is not considered a depleted or strategic stock under the MMPA. Dall's porpoise does not have a State status.

10.2.18 Harbor Seals (*Phoca vitulina*)

10.2.18.1 Distribution and Migration

Harbor seals are widely distributed in coastal waters all along the West Coast and in protected waters and estuaries throughout their range. Harbor seals are thought to be non migratory, although seasonal movements in the hundreds of kilometers have been documented in some regions. Despite these movements, there has been evidence of geographic structure among areas based on mtDNA, timing of births, pelage coloration, and contaminant concentrations (Kelly 1981; Calambokidis et al. 1985; Huber et al. 1994; Tempte 1994; Westlake and O'corry-Crowe 2002; O'corry-Crowe et al. 2003). NMFS recognizes several management stocks of harbor seals along the West Coast, including those in (1) California, (2) outer coasts of Oregon and Washington, and (3) inland waters of Washington.

Harbor seals are widely distributed throughout the Southern California Bight; the primary haul-out areas for harbor seals are on the Channel Islands, primarily Santa Rosa, Santa Cruz, San Miguel, and San Nicolas Islands (Lowry et al. 2005). Primary mainland haul-out locations include Mugu Lagoon, Carpenteria, and Point Conception.

10.2.18.2 Abundance

Harbor seals utilize numerous small haul-out areas where they typically rest during low-tide cycles. Typically these consist of sand spits, tide flats, rocks, beaches, and sometimes human-made structures like docks, floats, or log booms. Most of the censuses of harbor seals have been conducted on the basis of counts of seals utilizing these haul-out areas and are typically based on

aerial surveys conducted at low tide during either the molt or the pupping season when counts are highest. These counts typically have been calibrated with satellite or radio-tagged animals to determine a correction factor for the proportion not hauled out. Details of the locations of all haul-out areas are published for some areas (Jefferies et al. 2000; Lowry et al. 2005)

Harbor seal abundance off California has increased with protection since the 1970s (Hanan 1996). The most recent population estimates for harbor seals is 34,233 for all of California in 2004 (Lowry et al. 2005; Carretta et al. 2008). Lowry et al. (2005) provides a breakdown by region and 0.5-degree stratum for California, although these do not include the correction factor used by Carretta et al. (2008) to estimate total population size.

10.2.18.3 Foraging and Ecological Context

Harbor seals are considered opportunistic feeders, taking advantage of a wide variety prey. Their prey often varies between regions and seasons, reflecting differences in what is abundant and easy to catch. Harbor seals have been known to take commercially valuable fish, and they were the object of programs to reduce their numbers because of this. More recent research has demonstrated that relatively small numbers of commercially valuable fish are taken by these seals and these are primarily in the context of either feeding near the mouth of rivers when salmon are running or taking fish that are already hooked or caught in gill nets. Harbor seals are known prey of killer whales and sharks (Scheffer and Slipp 1944; Jefferson et al. 1991; Weller 2002).

10.2.18.4 Status/Threats

While there are no good data on historical harbor seal abundance, populations along the West Coast appear to have reached equilibrium carrying capacity and have stabilized. These may even approach some of the levels reported earlier for some of these areas (Scheffer and Slipp 1944), although this is hard to evaluate overall.

Harbor seals are killed incidentally to a variety of fishing operations all along the West Coast. A wide variety of human-related causes of death have been documented in harbor seal populations along the West Coast, including entanglement in fishing nets, shooting, and other trauma. High levels of contaminants have also been documented in harbor seals from some areas. None of these appears to have prevented the population from recovering. Harbor seals could be more vulnerable to future disease outbreaks as a result of immune suppression from contaminant concentrations.

10.2.19 California Sea Lions (*Zalophus californianus*)

10.2.19.1 Distribution and Migration

California sea lions occur in the eastern North Pacific. NMFS divides these into three stocks, two of them in Mexico and one that ranges from Southern California into waters off British Columbia (Carretta et al. 2008). California sea lions breed off the coast of Mexico and Southern California, with primarily males migrating north during the nonbreeding season. While there is some interchange among animals in these areas, especially adult males from Baja coming into U.S. waters, there are also some indications of genetic differences among these areas. California

sea lions in Northern California, Oregon, and Washington are almost exclusively males that migrate north to feed during the nonbreeding season.

The primary breeding grounds for California sea lions in U.S. waters is in the Southern California Bight, primarily on the islands of San Nicholas, Santa Barbara, San Clemente, and San Miguel (Lowry and Forney 2005). These islands are used by all age classes in the spring reproductive season. California sea lions are widely distributed throughout the waters of the Southern California Bight. California sea lions also haul out to rest on other islands, beaches, and buoys throughout this region.

10.2.19.2 Abundance

California sea lion populations have increased steadily since they became protected species. The California stock is estimated at 238,000 based on an extrapolation from the estimated 55,519 pups born in 2005 (Carretta et al. 2008). Alternately, a minimum population of 141,842 was determined from counts of all age and sex classes ashore at major rookeries and haul-out areas during July 2005, at the end of the breeding season. During the nonbreeding season some additional adult males from Mexico likely come into U.S. waters.

Trends in California sea lion pup production show the strong influence of El Niño events, which dramatically reduced pup production in 1983–84, 1992–93, 1998, and 2003. In most cases, these El Niño events primarily altered survival of birthed pups, and reproduction bounced back afterward. However, in some cases, such as 1983–84, adult survivorship was also affected. Trends in pup counts (excluding El Niño years) indicated the population may have reached maximum net productivity (population level with largest increase in abundance) in 1997 and may have now reached carrying capacity (Carretta et al. 2008).

10.2.19.3 Foraging and Ecological Context

California sea lions feed on a diverse diet of fish and squid. Primary prey includes anchovy, sardines, mackerel, rockfish, and market squid. They feed both solitarily and in large aggregations. They frequently interact with a wide variety of commercial and recreational fishing operations. In many types of net-fishing operations, California sea lions have learned to take fish out of the nets or take bites out of them. In areas where salmon and steelhead migrations up river systems is constrained by dams and locks, California sea lions have learned to prey on the fish that have little cover and a limited passage-way.

10.2.19.4 Status/Threats

California sea lions are not listed under the ESA and they are not considered depleted under the MMPA. As the population approaches carrying capacity, increased mortality has also been observed in recent years from a variety of sources including *Leptospira* outbreaks, demoic acid toxicity, and hookworm infestations.

California sea lions, as a result of their frequent interactions with humans, often are subject to a variety of human-caused injuries and mortalities. California sea lions' interaction with commercial and recreational fishing operations have resulted in numerous injuries and deaths of animals due to entanglement in fishing gear. A wide range of fisheries are involved. Predation

by California sea lions on endangered salmon populations have resulted in a program of capture and now lethal removal of some animals. Examinations of stranded animals have revealed a range of other human caused mortalities including shootings and boat collisions.

10.2.20 Steller Sea Lion (*Eumetopias jubatus*)

10.2.20.1 Distribution and Migration

Steller sea lions (sometimes called northern sea lions) are widely distributed from California around the Pacific Rim to northern Japan (Carretta et al. 2008). Steller sea lions in U.S. waters have been divided for management into an eastern and western stock divided by at longitude 144° W, although there has been disagreement over the locations for this dividing line. Steller sea lions are considered nonmigratory although there are extensive movements in some areas. There appears to be a relatively high site fidelity to natal rookery.

Steller sea lions historically used Southern California but there has been an elimination of breeding by this species in Southern California, possibly driven by warming temperatures. The Channel Islands were a breeding area into the 1980s but this species is not typically seen there currently.

10.2.20.2 Abundance

The total population size of the eastern stock of Steller sea lions (California through SE Alaska) is extrapolated from pup counts taken from 2002 to 2005, which were 45,095 to 55,832 depending on the correction factor used (Carretta et al. 2008). The majority of this population is in British Columbia and SE Alaska.

10.2.20.3 Foraging and Ecological Context

Steller sea lions feed on a wide variety of fish as well as invertebrates. Important prey items include various cod, mackerel, squid, octopus, herring, flatfish, and sculpins. They are known to prey on commercially valuable fish species such as salmon, especially around river mouths when salmon are concentrating.

10.2.20.4 Status/Threats

Steller sea lions have undergone serious declines in several parts of their range. The western U.S. stock is now recognized as endangered under the ESA, as well as depleted under the MMPA, as a result of a dramatic decline since the 1970s. One of its primary suspected causes is the depletion of their prey due to the commercial midwater trawl fishery for Pollock that takes one of the primary prey of Steller sea lions. Other studies have suggested that a broader regime shift has played a role in the decline by forcing sea lions to shift to a less ideal diet (Trites and Donnelly 2003). Killer whale predation has also been suggested as a cause for the decline (Springer et al. 2003).

The eastern U.S. stock of Steller sea lions that includes the animals in the Northern Study Area, has fared better, although, as mentioned above, there have been declines at the southern end of the range in California. The eastern U.S. stock is listed as threatened under the ESA and

depleted under the MMPA. Critical habitat under the ESA has been designated for some of the rookeries in California and southern Oregon.

10.2.21 Northern Elephant Seal (*Mirounga angustirostris*)

10.2.21.1 Distribution and Migration

Northern elephant seals use breeding areas primarily off California and Mexico, but range much wider for feeding, with males moving into the North Pacific and into the Gulf of Alaska and females generally staying south of 45° N (Stewart and Huber 1993). NMFS recognizes a California breeding stock for the sake of management in U.S. waters (Carretta et al. 2008). The breeding season is generally December through March (Stewart and Huber 1993). Adults also return to land between March and August to molt. Northern elephant seals breed on islands off the coast of Mexico, in Southern California (Channel Islands), and in central California (Año Nuevo Island and mainland, southeast Farallon Islands, and Point Reyes). During the nonbreeding season, they range along the coast of Oregon, Washington, and Alaska, as far north as the Gulf of Alaska and west to the Aleutian Islands (Condit and Le Boeuf 1984; Delong and Stewart 1991; Reeves et al. 1992). Adult males and females make two foraging migrations each year to separate areas of the North Pacific, with males traveling to the Gulf of Alaska and along the Aleutian Islands and females visiting areas farther south offshore of Washington and Oregon (Stewart and Delong 1990).

The majority of the northern elephant seal population breeds in the Southern California Bight. Breeding locations for northern elephant seals in the Southern California Bight include San Miguel and San Nicholas Islands.

10.2.21.2 Abundance

Northern elephant seals were reduced to a few hundred individuals by hunting (Stewart and Huber 1993). The population has made a strong recovery and was estimated to number 124,000 in 2005 (Carretta et al. 2008) based on pups born and a multiplier for other age groups (Stewart et al. 1994).

10.2.21.3 Foraging and Ecological Context

Northern elephant seals primarily eat vertically migrating epi- and mesopelagic squid, in addition to Pacific whiting, cusk-eels, rockfish, sharks, rays, and ratfish (Condit and Le Boeuf 1984; Delong and Stewart 1991; Sinclair 1994). Recent data on adult males and females show they feed in deep waters seaward of the continental slope, repeatedly making long, deep dives (Le Boeuf et al. 1986; Reeves et al. 1992).

10.2.21.4 Status/Threats

The reduction of northern elephant seals to a few tens or hundreds of animals has resulted in a low level of genetic variation in the remaining population, potentially making them more vulnerable to new threats. Northern elephant seals are occasionally taken in low numbers in the California/Oregon thresher shark/swordfish drift gillnet fishery. Given their successful population recovery, northern elephant seals are not listed under the ESA and are not considered depleted under the MMPA.

10.2.22 Northern Fur Seal (*Callorhinus ursinus*)

10.2.22.1 Distribution and Migration

Northern fur seals breed on Robben Island, Japan; the Kuril and Commander Islands, Russia; the Pribilof Islands and Bogoslof Island, Alaska; and San Miguel Island, California. Females and juveniles from the primary breeding grounds in Alaska migrate south along the West Coast of the United States after the summer breeding season to areas off the coast of British Columbia, Washington, Oregon, and California. In the winter and spring, large numbers of fur seals, primarily migrants from the Bering Sea populations, feed along the California coast beyond the edge of the continental shelf (Fiscus and Kajimura 1969; Bonnell et al. 1980). Animals from a small breeding colony on San Miguel Island, in the Southern California Bight also feed off the West Coast.

NMFS recognizes two stocks of northern fur seals using U.S. waters for the sake of management: an eastern Pacific stock that breeds in the Pribilof Islands and migrates during winter months to waters of Alaska, British Columbia, Washington, Oregon, and California, and a San Miguel Island stock that breeds on San Miguel Island and feeds off the West Coast (Carretta et al. 2008).

Within the SCB, this species is found during the breeding season at San Miguel Island, the only breeding areas off California. They feed primarily along the Santa Rosa Cortes Ridge and near the Tanner Bank (Bonnell et al. 1980). Northern fur seals radio-tagged in the summer on San Miguel Island, the sole breeding ground in California, foraged northwest of the island in oceanic waters over the continental slope (Antonelis et al. 1990).

10.2.22.2 Abundance

Abundance of northern fur seals in the eastern North Pacific stock has been declining since the early 1970s when the total population was estimated as 1.25 million. Current estimates are about half this number, 665,550, extrapolated from the number of pups born (Carretta et al. 2008). The San Miguel Island stock has generally been increasing, except for declines during El Niño events, and is estimated at just under 10,000 as of 2005 (Carretta et al. 2008). Declines in the population of this species in the last 30 years have been attributed to a variety of factors including the long-term effects of a kill of young females in the 1950s and 1960s (York and Hartley 1981), entanglement in discarded pieces of nets (Fowler 1982), ecosystem changes, and killer whale predation (Springer et al. 2003).

10.2.22.3 Foraging and Ecological Context

Northern fur seals have been documented feeding on 53 species of fish and 10 species of squid (Kajimura 1984). Primary prey in northern waters is herring, capelin, sand lance, sablefish, and pollock (Kajimura 1984). Off California, primary prey is anchovy, whiting, saury, rockfish, and jack mackerel (Kajimura 1984). Predominant prey of fur seals examined on San Miguel Island in the SCB is whiting, Californian lanternfish, several species of squids, jack mackerel, and anchovy (Antonelis et al. 1990; Delong and Antonelis 1991).

10.2.22.4 Status/Threats

Although not listed under the ESA, the eastern North Pacific stock of northern fur seals is considered depleted under the MMPA due to the decline in abundance that has occurred. The San Miguel stock is not considered depleted under the MMPA.

10.2.23 Guadalupe Fur Seal (*Arctocephalus townsendi*)

10.2.23.1 Distribution and Migration

Guadalupe fur seals primarily breed at Isa Guadalupe in Mexico. Once thought to have gone extinct, they have made a comeback and appear to be expanding back into their former range that includes the waters of the West Coast. They are now being sighted off California and as far north as Washington and British Columbia (Hanni et al. 1997; Carretta et al. 2008). In the Southern California Bight, they have been seen on California sea lion rookeries in the Channel Islands (Stewart et al. 1987); and pups were documented being born on San Miguel Island (Melin and DeLong 1999).

10.2.23.2 Abundance

The most recent abundance estimate for this species is based on pup counts from 1993 and indicates an estimated total abundance of 7,408 (Carretta et al. 2008).

10.2.23.3 Foraging and Ecological Context

They generally feed in offshore waters after leaving their breeding island. An adult female Guadalupe fur seal rehabilitated, satellite tagged, then released off Northern California traveled back to Guadalupe Island, then back north on a similar offshore track over 1,400 km before transmissions ended 315 km off of Northern California (Lander et al. 2000).

10.2.23.4 Status/Threats

The Guadalupe fur seal was listed as threatened throughout its range on December 16, 1985 under the ESA and is also protected under the Marine Mammal Protection Act of 1972, as amended. In 1975, the government of Mexico declared Guadalupe Island a pinniped sanctuary. NMFS has classified the U.S. Guadalupe fur seal stock as a strategic stock.

10.2.24 Sea Otter (*Enhydra lustris*)

10.2.24.1 Distribution and Migration

The historic range of the sea otter encompassed the temperate coastal waters of the North Pacific Rim from northern Japan, through Russia, Alaska, British Columbia, Washington, and Oregon to California. Two centuries of commercial exploitation reduced the range to small scattered groups in Russia, the Aleutian Islands, Alaska Peninsula, Kodiak Archipelago, Prince William Sound, and California. Attempts to reestablish populations by translocation on the Pribilof Islands, in Southeast Alaska, British Columbia, Washington, and Oregon have been variably successful, with apparent failure in Oregon and on the Pribilof Islands (Jameson et al. 1982; Jameson et al. 1986). The success of a recent translocation to San Nicolas Island, California is still undetermined (Rathbun et al. 1989; Reidman and Estes 1990).

Outside of the 1987 translocation to San Nicolas Island, otters have not otherwise inhabited the SCB this century. Otters are capable of traveling long distances, and have occasionally been seen in the SCB. However, the southernmost extension of their range is approximately 50 km north of Point Conception, the northernmost point of the SCB. Lifetime home ranges for female and male otters of 18 and 80 km, respectively, place all but a small fraction of the population out of reach of the SCB and clearly beyond the coastal waters in the central SCB.

10.2.24.2 Abundance

Prior to exploitation, as many as 16,000-20,000 otters may have lived in California and Baja California, with highest abundance in the Channel Islands and northern and central California (Keynon 1969). Recent (1989) counts showed 1,864 otters in central and Northern California (Jameson and Estes, unpub data in Reidman and Estes 1990) and an additional 22 on San Nicolas Island (Rathbun et al. 1989).

10.2.24.3 Foraging and Ecological Context

The diet of the sea otter varies considerably among individuals and in California consists mainly of abalone, red sea urchins, and rock crabs (Reidman and Estes 1990). Otters in this region also consume kelp crabs, various species of clams, turban snails, mussels, octopus, sea stars, fat innkeeper worms, chitons, and seabirds (Estes et al. 1982; Reidman and Estes 1990). Predation on fish is rare in contrast to sea otters in Russia and Alaska, where epibenthic fish were also commonly consumed.

10.2.24.4 Status/Threats

The reasons for the slower recovery of this species in California are uncertain, but could be related to changes in emigration, natality, or mortality. Reidman and Estes (1990) suggest increased mortality as the primary cause, citing minimal occurrence of extralimital sightings north of the established California range and natality estimates similar to that of Alaskan populations. Early pup survival in California appears lower in central California than in Alaska: 50 percent (Siniff and Ralls 1988) compared to nearly 100 percent (Monnet and Rotterman 1988), respectively. Similar comparisons for adults were precluded by limited data from Alaska. The most significant causes of mortality appear to be drowning in commercial fishing nets, white shark attack, a combination of pathological disorders, starvation, adverse winter weather, and possible shooting incidents (Reidman and Estes 1990).

One of the most significant causes of mortality has been net entanglement. Mortality estimates based on 1,068 carcasses recovered show 4 percent of deaths caused by drowning in set nets (Reidman and Estes 1990). However, estimates correcting for the small proportion of set nets sampled show as many as 168 otters per year, or about 10 percent of the California population, may have been killed in nets during the years prior to the 1985 ban on gill and trammel net fisheries (Reidman and Estes 1990). While pathological disorders, primarily enteritis and pneumonia, accounted for only 4 percent of otter deaths, over 50 percent of deaths were from unknown causes related to starvation. Whether these deaths result from limits to food availability or foraging ability, or were the byproduct of disease affecting foraging ability, is difficult to determine (Reidman and Estes 1990).

10.3 LIST OF LITERATURE CITED—MARINE MAMMALS

- Aguilar, A. 2002. Fin whale, *Balaenoptera physalus*. In: Perrin, W.F., B. Wursig, and J.G.M. Thewissen. Encyclopedia of marine mammals. San Diego, CA: Academic Press. Pp. 435-438.
- Angliss, R.P. and B.M. Allen. 2008. North Pacific right whale (*Eubalaena japonica*) In: Alaska Marine Mammal Stock Assessments, 2008. NOAA Technical Memorandum NMFS-AFSC-193. Pp. 188-193.
- Antonelis, G.A., B.S. Stewart and W.F. Perryman. 1990. Foraging characteristics of female northern fur seals (*Callorhinus ursinus*) and California sea lions (*Zalophus californianus*). Canadian Journal of Zoology 68:150-158.
- Baird, R.W. 2001. Status of killer whales in Canada. Canadian Field-Naturalist 115:676-701.
- Baird, R.W. 2002. Risso's dolphin, *Grampus griseus*. In: Perrin, W.F., B. Wursig, and J. G.M. Thewissen. Encyclopedia of marine mammals. San Diego, CA: Academic Press.
- Baird, R.W. and L.M. Dill. 1995. Occurrence and behavior of transient killer whales: Seasonal and pod-specific variability, foraging behavior and prey handling. Canadian Journal of Zoology 73:1300-1311.
- Baird, R.W. and T.J. Guenther. 1995. Account of harbour porpoise (*Phocoena phocoena*) strandings and bycatches along the coast of British Columbia. Report for the International Whaling Commission Special Issue 16:159-169.
- Baird, R.W. and P.J. Stacey. 1988. Variation in saddle patch pigmentation in populations of killer whales (*Orcinus orca*) from British Columbia, Alaska, and Washington State. Canadian Journal of Zoology 66(11):2582-2585.
- Baird, R.W., P.J. Stacey, D.A. Duffus, and K.M. Langelier. 2002. An evaluation of gray whale (*Eschrichtius robustus*) mortality incidental to fishing operations in British Columbia, Canada. Journal of Cetacean Research and Management 4(3):289-296.
- Baird, R.W. and H. Whitehead. 2000. Social organization of mammal-eating killer whales: Group stability and dispersal patterns. Canadian Journal of Zoology 78:2096-2105.
- Baird, R.W., P.M. Willis, T.J. Guenther, P.J. Wilson, and B.N. White. 1998. An intergeneric hybrid in the family *Phocoenidae*. Canadian Journal of Zoology 76:198-204.
- Baker, C.S., S.R. Palumbi, R.H. Lambertson, M.T. Weinrich, J. Calambokidis and S.J. O'brien. 1990. Influence of seasonal migration on geographic distribution of mitochondrial DNA haplotypes in humpback whales. Nature 344:238-240.
- Baker, C.S., R.W. Slade, J.L. Bannister, R.B. Abernethy, M.T. Weinrich, J. Lien, J. Urban, P. Corkerson, J. Calambokidis, O. Vasquez and S.R. Palumbi. 1994. Hierarchical structure of

- mitochondrial DNA gene flow among humpback whales *Megaptera novaeangliae*, world-wide. *Molecular Ecology* 3:313-327.
- Balance, L.T. 2002. Cetacean ecology. In: Perrin, W.F., B. Wursig, and J.G.M. Thewissen. *Encyclopedia of marine mammals*. San Diego, CA: Academic Press. Pp. 208-214.
- Balcomb, K. and D.E. Claridge. 2001. A mass stranding of cetaceans caused by naval sonar in the Bahamas. *Bahamas Journal of Science* 5:2-12.
- Barlow, J. 1994. Abundance of large whales in California coastal waters: A comparison of ship surveys in 1979/80 and in 1991. In: Donovan, G. *Forty-fourth Report of the International Whaling Commission*, Cambridge 44:51-56.
- Barlow, J. 1995. The abundance of cetaceans in California waters. Part 1: Ship surveys in summer and fall of 1991. *Fishery Bulletin* 93(1):1-14.
- Barlow, J. 1997. Preliminary estimates of cetacean abundance off California, Oregon, and Washington based on a 1996 ship survey and comparisons of passing and closing modes. U.S. Dept.of Commerce, NOAA. SWFSC Administrative Report LJ-97-11. 25 pp.
- Barlow, J., M.C. Ferguson, W.F. Perrin, L. Ballance, T. Gerrodette, G. Joyce, C.D. Macleod, K. Mullin, D.L. Palka and G. Waring. 2006. Abundance and densities of beaked and bottlenose whales (family *Ziphiidae*). *Journal of Cetacean Research and Management* 7(3):263-270.
- Barlow, J. and K.A. Forney. 2007. Abundance and population density of cetaceans in the California Current ecosystem. *Fishery Bulletin* 105(4):509-526.
- Barlow, J. and B. Taylor. 2005. Estimates of sperm whale abundance in the northeastern temperate Pacific from a combined acoustic and visual survey. *Marine Mammal Science* 21(3):429-445.
- Barlow, J. and B.L. Taylor. 2001. Estimates of large whale abundance off California, Oregon, Washington, and Baja California based on 1993 and 1996 ship surveys. NMFS. Southwest Fisheries Science Center, NOAA. LJ-01-03. 11 pp.
- Bigg, M.A., G.M. Ellis, J.K.B. Ford, and K.C. Balcomb. 1987. *Killer whales of the Pacific Northwest: Their identification, genealogy and natural history*. Vancouver, BC: West Coast Whale Research.
- Black, N., A. Schulman, D.K. Ellifrit, D. Shearwater, A. Baldrige, R.L. Ternullo, D. Goley, J. Calambokidis and M. Webber. 1993. Photo-identification of killer whales off California. In: *Tenth Biennial Conference on the Biology of Marine Mammals*, Galveston. Society for Marine Mammal Biology.
- Black, N.A., A. Schulman-Janiger, R.L. Ternullo and M. Guerrero-Ruiz. 1997. *Killer whales of California and Western Mexico: A catalog of photo-identified individuals*. U.S. Dept. of Commerce. NOAA Technical Memorandum NOAA-TM-NMFS-SWFSC-247. 180 pp.

- Bonnell, M.L., B. Le Boeuf, M. Pierson, D.H. Dettman, G.D. Farrens, C.B. Heath, R.F. Gantt and D.J. Larsen. 1980. Pinnipeds of the Southern California Bight. In: Marine mammal and seabird surveys of the Southern California Bight area 1975-1978. Final Report to U.S. Dept. of the Interior, Minerals Management Service. 535 pp.
- Braham, H. W. 1984. Distribution and migration of gray whales in Alaska. In: Jones, M.L., S.L. Swartz, and S. Leatherwood. The Gray Whale, *Eschrichtius robustus*. Orlando, FL: Academic Press. Pp. 249-266.
- Brownell, R.L., Jr, P.J. Clapham, T. Miyashita and T. Kasuya. 2001. Conservation status of North Pacific right whales. *Journal of Cetacean Research and Management* (Special Issue) 2:269-286.
- Brownell, R.L., T. Yamada, J.G. Mead and A.L. Van Helden. 2004. Mass strandings of Cuvier's beaked whales in Japan: U.S. naval link? In: 56th Meeting of the International Whaling Commission, Sorrento, Italy. SC/56/E37: 10.
- Brueggeman, J.J., G.A. Green, K.C. Balcomb, C.E. Bowlby, R.A. Grotefendt, K.T. Briggs, M.L. Bonnell, R.G. Ford, D.H. Varoujean, D. Heinemann and D.G. Chapman. 1990. Oregon-Washington Marine Mammal Seabird Survey: Information synthesis and hypothesis formulation. U.S. Dept. of the Interior. OCS Study MMS 89-0030.
- Calambokidis, J. and R.W. Baird. 1994. Status of marine mammals in the Strait of Georgia, Puget Sound and the Juan de Fuca Strait and potential human impacts. In: Wilson, R.C.H., R.J. Beamish, F. Aitkens, and J. Bell. Review of the marine environment and biota of Strait of Georgia, Puget Sound and Juan de Fuca Strait, Marine Sciences Panel of the British Columbia/Washington Environmental Cooperation Council. Pp. 282-300.
- Calambokidis, J. and J. Barlow. 2004. Abundance of blue and humpback whales in the eastern North Pacific estimated by capture-recapture and line-transect methods. *Marine Mammal Science* 20(1):63-85.
- Calambokidis, J., J. Barlow, J.K.B. Ford, T.E. Chandler and A.B. Douglas. 2009. Insights into the population structure of blue whales in the eastern North Pacific from recent sightings and photographic identification. *Marine Mammal Science* 25(4):816-832, doi: 10.1111/j.1748-7692.2009.00298.x.
- Calambokidis, J., J.D. Darling, V. Deecke, P. Gearin, M. Goshko, W. Megill, C.M. Tombach, D. Goley, C. Toropova and B. Gisborne. 2002. Abundance, range and movements of a feeding aggregation of gray whales (*Eschrichtius robustus*) from California to southeastern Alaska in 1998. *Journal of Cetacean Research and Management* 4(3):267-276.
- Calambokidis, J., E.A. Falcone, T.J. Quinn, A.M. Burdin, P.J. Clapham, J.K. B. Ford, C.M. Gabriele, R. Deduc, D. Mattila, L. Rojas-Bracho, J.M. Straley, B.L. Taylor, J. Urban-R, D. Weller, B.H. Witteveen, M. Yamaguchi, A. Bendlin, D. Camacho, K.R. Flynn, A. Havron, J. Huggins and N. Maloney. 2008. SPLASH: Structure of populations, levels of abundance

- and status of humpback whales in the North Pacific. Contract Report to U.S. Dept. of Commerce, NOAA, Cascadia Research, Olympia, WA.
- Calambokidis, J., S.M. Speich, J. Peard, G.H. Steiger, J.C. Cubbage, D.M. Fry and L.J. Lowenstine. 1985. Biology of Puget Sound marine mammals and marine birds: population health and evidence of pollution effects. Contract Report to U.S. Dept. of Commerce, NOAA, Cascadia Research, Olympia, WA. 159 pp.
- Calambokidis, J., G.H. Steiger, J.C. Cubbage, K.C. Balcomb, C. Ewald, S. Kruse, R. Wells and R. Sears. 1990. Sightings and movements of blue whales off central California 1986-88 from photo-identification of individuals. (*Balaenoptera musculus*). In: Report of the International Whaling Commission, Special Issue 12:343-348.
- Calambokidis, J., G.H. Steiger, D.K. Ellifrit, B.L. Troutman and C.E. Bowlby. 2004. Distribution and abundance of humpback whales (*Megaptera novaeangliae*) and other marine mammals off the northern Washington coast. Fishery Bulletin 102(4):563-580.
- Calambokidis, J., G.H. Steiger, J.R. Evenson, K.R. Flynn, K.C. Balcomb, D.E. Claridge, P. Bloedel, J.M. Straley, C.S. Baker and O. Von Ziegesar. 1996. Interchange and isolation of humpback whales off California and other North Pacific feeding grounds. Marine Mammal Science 12(2):215-226.
- Calambokidis, J., G.H. Steiger, K. Rasmussen, J. Urban-R, K.C. Balcomb, P. Ladron De Guevara, M. Salinas-Z, J.K. Jacobsen, C.S. Baker, L.M. Herman, S. Cerchio and J.D. Darling. 2000. Migratory destinations of humpback whales that feed off California, Oregon and Washington. (*Megaptera novaeangliae*). Marine Ecology Progress Series 192:295-304.
- Calambokidis, J., G.H. Steiger, J.M. Straley, L.M. Herman, S. Cerchio, D. Salden, J. Urban-R, J.K. Jacobsen, O. Von Ziegesar, K.C. Balcomb, C.M. Gabriele, M. Dahlheim, S. Uchida, G. Ellis, Y. Miyamura, P. De Guevara, M. Yamaguchi, F. Sato, S.A. Mizroch, L. Schlender, K. Rasmussen, J. Barlow and T.J. Quinn. 2001. Movements and population structure of humpback whales in the North Pacific. Marine Mammal Science 17(4):769-794.
- Caldwell, D.K. and M.C. Caldwell. 1989. Pygmy sperm whale, *Kogia breviceps* (de Blainville, 1838): Dwarf sperm whale, *Kogia simus* (Owen, 1866). In: Ridgway, S.H. and R. Harrison. Handbook of marine mammals. Pp. 235-260.
- Carretta, J.V., K.A. Forney, M.S. Lowry, J. Barlow, J. Baker, D. Johnston, B. Hanson, M.M. Muto, D. Lynch and L. Carswell. 2008. U.S. Pacific marine mammal stock assessments: 2008. U.S. Dept. of Commerce, NMFS. NOAA Technical Report NOAA-TM-NMFS-SWFSC-434.
- Carretta, J.V., M.S. Lynn and C.A. Leduc. 1994. Right whale (*Eubalaena glacialis*) sighting off San Clemente Island, California. Marine Mammal Science 10(1):101-105.
- Clapham, P.J., C. Good, S.E. Quinn, R.R. Reeves, J.E. Scarff and R.L. Brownell. 2004. Distribution of North Pacific right whales (*Eubalaena japonica*) as shown by 19th and 20th

- century whaling catch and sighting records. *Journal of Cetacean Research and Management* 6(1):1-6.
- Clapham, P.J., S. Leatherwood, I. Szczepaniak and R.L. Brownell, Jr. 1997. Catches of humpback and other whales from shore stations at Moss Landing and Trinidad, California, 1919-1926. *Marine Mammal Science* 13(3):368-394.
- Clapham, P.J., S.B. Young and R.L. Brownell. 1999. Baleen whales: Conservation issues and the status of the most endangered populations. *Mammal Review* 29(1):35-60.
- Condit, R. and B. Le Boeuf. 1984. Feeding habits and feeding grounds of the northern elephant seal. *Journal of Mammalogy* 65:281-290.
- Cox, T. M., T.J. Ragen, A.J. Read, E. Vos, R.W. Baird, K. Balcomb, J. Barlow, J. Caldwell, T. Cranford, L. Crum, A. D'amico, G. D'spain, A. Fernández, J. Finneran, R. Gentry, W. Gerth, F. Gulland, J. Hildebrand, D. Houser, T. Huller, P.D. Jepson, D. Ketten, C.D. Macleod, P. Miller, S. Moore, D.C. Mountain, D. Palka, P. Ponganis, S. Rommel, T. Rowles, B. Taylor, P. Tyack, D. Wartzok, R. Gisiner, J. Mead and L. Brenner. 2006. Understanding the impacts of anthropogenic sound on beaked whales. *Journal of Cetacean Research and Management* 7(3):177-187.
- Croll, D.A., C.W. Clark, J. Calambokidis, W.T. Ellison and B.R. Tershy. 2001. Effect of anthropogenic low-frequency noise on the foraging ecology of *Balaenoptera* whales. *Animal Conservation* 4(1):13-27.
- Darling, J.D. 1984. Gray whales off Vancouver Island, British Columbia. In: Jones, M.L., S. L. Swartz, and S. Leatherwood. *The Gray Whale, Eschrichtius robustus*. Orlando, FL: Academic Press. Pp. 267-287.
- Defran, R.H. and D.W. Weller. 1999. Occurrence, distribution, site fidelity, and school size of bottlenose dolphins (*Tursiops truncatus*) off San Diego, California. *Marine Mammal Science* 15(2):366-380.
- Defran, R.H., D.W. Weller, D.L. Kelly and M.A. Espinosa. 1999. Range characteristics of Pacific Coast bottlenose dolphins (*Tursiops truncatus*) in the Southern California Bight. *Marine Mammal Science* 15(2):381-393.
- Delong, R.L. and G.A. Antonelis. 1991. Impact of the 1982-1983 El Niño on the northern fur seal population at San Miguel Island, California. In: Trillmich, F. and K.A. Ono. *Pinnipeds and El Niño: Responses to environmental stress*. Berlin: Springer-Verlag. Pp. 75-83.
- Delong, R.L. and B.S. Stewart. 1991. Diving patterns of northern elephant seal bulls. *Marine Mammal Science* 7(4):369-384.
- Dohl, T.P. 1983. Cetaceans of central and Northern California, 1980-1983: Status, abundance, and distribution. Contract Report to Pacific OCS, U.S. Dept. of the Interior, MMS. 284 pp.

- Dohl, T.P., M.L. Bonnell and R.G. Ford. 1986. Distribution and abundance on common dolphin, *Delphinus delphis*, in the Southern California Bight: A quantitative assessment based upon aerial transect data. *Fishery Bulletin* 84:333-343.
- Dohl, T.P., K.S. Norris, R.C. Guess, J.D. Bryant and M.W. Honig. 1981. Cetacea of the Southern California Bight. NTIS Report # PB81-248-189. 414 pp.
- Donovan, G. 1991. A review of IWC stock boundaries. In: Report of the International Whaling Commission, Special Issue 13:39-68.
- Doroshenko, N.V. 2000. Soviet whaling for blue, gray, bowhead and right whales in the North Pacific Ocean, 1961-1979. Center for Russian Environmental Policy, Marine Mammal Council, Moscow. Pp. 96-103.
- Dorsey, E.M. 1983. Exclusive adjoining ranges of individually identified minke whales (*Balaenoptera acutorostrata*) in Washington State. *Canadian Journal of Zoology* 61:174-181.
- Dorsey, E.M., S.J. Stern, A.R. Hoesel and J. Jacobsen. 1990. Minke whales (*Balaenoptera acutorostrata*) from the West Coast of North America: Individual recognition and small-scale site fidelity. Report of the International Whaling Commission Special Issue 12:357-368.
- Douglas, A.B., J. Calambokidis, L.M. Munger, M.S. Soldevilla, A.M. Havron, D.L. Camacho, G.S. Campbell and J.A. Hildebrand. In preparation. Seasonality, diversity and relative density of marine mammals off Southern California, based on sighting data collected on quarterly California Cooperative Oceanic Fisheries Investigation cruises 2004-2008.
- Douglas, A.B., J. Calambokidis, S. Raverty, S.J. Jefferies, D.M. Lambourn and S.A. Norman. 2008. Incidence of ship strikes of large whales in Washington State. *Journal of the Marine Biological Association of the United Kingdom* 88(6):1121-1132.
- Dudzik, K.J., K.M. Baker and D.W. Weller. 2006. Mark-recapture abundance estimate of California coastal stock bottlenose dolphins: February 2004 to April 2005. NMFS. Southwest Fisheries Science Center, NOAA. Administrative Report LJ-06-02C. 15 pp.
- Estes, J.A., R.J. Jameson and E.B. Rhode. 1982. Activity and prey selection in the sea otter: Influence of population status on community structure. *American Naturalist* 120(2):242-258.
- Falcone, E.A., J. Calambokidis, G.H. Steiger, M. Malleson and J.K.B. Ford. 2005. Humpback whales in the Puget Sound/Georgia Strait region. In: Puget Sound Georgia Basin Research Conference, Seattle. Puget Sound Action Team.
- Fiscus, C.H. and H. Kajimura. 1969. Pelagic fur seal investigations, 1966. U.S. Dept. of the Interior. Washington, DC. 59 pp.

- Fiscus, C.H. and K. Niggol. 1965. Observations of cetaceans off California, Oregon and Washington. U.S. Fish and Wildlife Service. Special Scientific Report Fisheries 498. Pp. 1-27.
- Fitch, J.E. and R.L. Brownell. 1968. Fish otoliths in cetacean stomachs and their importance in interpreting feeding habits. *Journal of the Fisheries Research Board of Canada* 25(12):2561-2574.
- Ford, J., G. Ellis, L. Barrett-Lennard, A. Morton, R. Palm and K. Balcomb. 1998. Dietary specialization in two sympatric populations of killer whales (*Orcinus orca*) in coastal British Columbia and adjacent waters. *Canadian Journal of Zoology* 76(8):1456-1471.
- Ford, J.K.B., G.M. Ellis and K.C. Balcomb. 2000. Killer Whales: The natural history and genealogy of *Orcinus orca* in British Columbia and Washington University of British Columbia Press, Vancouver. 104 pp.
- Ford, J.K.B., G.M. Ellis, D.R. Matkin, K. C. Balcomb, D. Briggs and A.B. Morton. 2005a. Killer whale attacks on minke whales: Prey capture and antipredator tactics. *Marine Mammal Science* 21(4):603-618.
- Ford, J. K.B., G.M. Ellis and P.F. Olesiuk. 2005b. Linking prey and population dynamics: did food limitation cause recent declines of 'resident' killer whales (*Orcinus orca*) in British Columbia? Department of Fisheries and Oceans Canada Research Document 2005/042.
- Forney, K.A. 2007. Preliminary estimates of cetacean abundance along the U.S. West Coast and within four national marine sanctuaries during 2005. NOAA Technical Memorandum NMFS-SWFSC-406. 33 pp.
- Forney, K.A., J. Barlow and J.V. Carreta. 1995. The abundance of cetaceans in California waters. Part II: Aerial surveys in winter and spring of 1991 and 1992. *Fishery Bulletin* 93(1):15-26.
- Forney, K.A. and R.L. Brownell. 1996. Preliminary report of the 1994 Aleutian Island Marine Mammal Survey. In: International Whaling Commission, Aberdeen, Scotland. Working Paper SC/48/O11.
- Forney, K.A. and P.R. Wade. 2006. Worldwide distribution and abundance of killer whales. In: Estes, J.A., D.P. DeMaster, D.F. Doak, T.M. Williams, and R.L. Brownell, Jr. Whales, whaling, and ocean ecosystems. Berkeley, CA: University of California Press. Pp. 145-162.
- Fowler, C.W. 1982. Interactions of northern fur seals and commercial fisheries. In: Transactions of the North American Wildlife Conference 47:278-292.
- Frantzis, A. 1998. Does acoustic testing strand whales? *Nature* 392:29.
- Gilmore, R.M. 1956. Rare right whale visits California. *Pacific Discovery* 9(4):20-25.

- Gosho, M.E., D.W. Rice, and J.M. Breiwick. 1984. The sperm whale, *Physeter macrocephalus*. *Marine Fisheries Review* 46 (4):54-64.
- Green, G. A., J.J. Brueggeman, R.A. Grotefendt and C.E. Bowlby. 1995. Offshore distances of gray whales migrating along the Oregon and Washington coasts, 1990. (*Eschrichtius robustus*). *Northwest Science* 69(3):223-227.
- Green, G.A., J.J. Brueggeman, R.A. Grotefendt, C.E. Bowlby, M.L. Bonnell and K.C. Balcomb, Iii. 1992. Cetacean distribution and abundance off Oregon and Washington, 1989-1990. Final Report to Pacific OCS, U.S. Dept. of the Interior, MMS. Ebasco Environmental, Seattle, WA. 100 pp.
- Gulland, F., H. Pérez-Cortés, M.J. Urbán, R.L. Rojas-Bracho, G. Ylitalo and J. Weir. 2005. Eastern North Pacific gray whale (*Eschrichtius robustus*) unusual mortality event, 1999–2000: a compilation. U.S. Department of Commerce, NOAA Technical Memorandum NMFS-AFSC-150. 44 pp.
- Hanan, D.A. 1996. Dynamics of abundance and distribution for Pacific harbor seal, *Phoca vitulina richardsi*, on the coast of California. PhD Dissertation, University of California-Los Angeles. 158 pp.
- Hanni, K.D., D.J. Long, R.E. Jones, P. Pyle and L.E. Morgan. 1997. Sightings and strandings of Guadalupe fur seals in Central and Northern California, 1988-1995. *Journal of Mammalogy* 78(2):684-690.
- Heimlich-Boran, J.R. 1988. Behavioral ecology of killer whales (*Orcinus orca*) in the Pacific Northwest. *Canadian Journal of Zoology* 66:565-578.
- Heise, K.A. 1997. Diet and feeding behaviour of Pacific white-sided dolphins (*Lagenorhynchus obliquidens*) as revealed through the collection of prey fragments and stomach content analyses. Report to the International Whaling Commission 47:807-815.
- Henderson, D.A. 1984. 19th century gray whaling-Grounds, catches and kills, practices and depletion of the whale population. In: Jones, M.L., S.L. Swartz, and S. Leatherwood. *The Gray Whale, Eschrichtius robustus*. New York: Academic Press. Pp. 159-186.
- Herzing, D.L. and B.R. Mate. 1984. Gray whale migrations along the Oregon Coast, 1978-1981. In: Jones, M.L., S.L. Swartz, and S. Leatherwood. *The Gray Whale*. New York: Academic Press. Pp. 289-308.
- Hewitt, R.P. and J.D. Lipsky. 2002. Krill and other plankton. In: Perrin, W.F., B. Wursig, and J. G.M. Thewissen. *Encyclopedia of marine mammals*. San Diego, CA: Academic Press. Pp. 676-684.
- Heyning, J.E. 2002. Cuvier's beaked whale, *Ziphius cavirostris*. In: Perrin, W.F., B. Wursig, and J.G.M. Thewissen. *Encyclopedia of marine mammals*. San Diego, CA: Academic Press.

- Heyning, J.E. and M.E. Dahlheim. 1990. Strandings and incidental takes of gray whales. International Whaling Commission Scientific Committee Document SC/A90/G2.
- Heyning, J.E. and W.F. Perrin. 1994. Evidence for two species of common dolphins (genus *Delphinus*) from the eastern North Pacific. Contributions in Science, Natural History Museum of Los Angeles County 442:1-35.
- Hoelzel, A.R., E.M. Dorsey and S.J. Stern. 1989. The foraging specializations of individual minke whales. Animal Behaviour 38:786-794.
- Hoelzel, A.R., A. Natoli, M.E. Dahlheim, C. Olavarria, R.W. Baird and N.A. Black. 2002. Low worldwide genetic diversity in the killer whale (*Orcinus orca*): Implications for demographic history. Proceedings of the Royal Society B: Biological Sciences 269(1499):1467.
- Horwood, J. 2002. Sei whale, *Balaenoptera borealis*. In: Perrin, W.F., B. Wursig and J.G.M. Thewissen. Encyclopedia of Marine Mammals. San Diego, CA: Academic Press. Pp. 1069-1071.
- Hoyt, E. 1984. Orca the whale called killer. Camden House. Ontario, Canada. 292 pp.
- Huber, H.R., S. Jefferies, R. Brown and R.L. Delong. 1994. Harbor seal stock assessment in Washington and Oregon 1993. Annual report to the MMPA Assessment Program, Office of Protected Resources, NMFS, NOAA.
- Jameson, R.J., K.W. Kenyon, S. Jeffries and G.R. Vanblaricom. 1986. Status of a translocated sea otter population and its habitat in Washington. The Murrelet 67:84-87.
- Jameson, R.J., K.W. Kenyon, A.M. Johnson and H.M. Wight. 1982. History and status of translocated sea otter populations in North America. Wildlife Society Bulletin 10:100-107.
- Jefferies, S.J., P.J. Gearin, H.R. Huber, D.L. Saul, and D.A. Pruett. 2000. Atlas of seal and sea lion haulout sites in Washington. Washington Dept. of Fish and Wildlife. Olympia. 157 pp.
- Jefferson, T.A., P.J. Stacey and R.W. Baird. 1991. A review of killer whale interactions with other marine mammals: Predation to co-existence. Mammal review 21(4):151-180.
- Jepson, P.D., M. Arbelo, R. Deaville, I. A.P. Patterson, P. Castro, J.R. Baker, E. Degollada, H.M. Ross, P. Herráez, A.M. Pockness, F. Rodriguez, F.E. Howie, A. Espinosa, R.J. Reid, J.R. Jaber, V. Martin, A.A. Cunningham and A. Fernandez. 2003. Gas-bubble lesions in stranded cetaceans: Was sonar responsible for a spate of whale deaths after an Atlantic military exercise? Nature 425(6958):575-576.
- Jones, I.M. 2006. A northeast Pacific offshore killer whale (*Orcinus orca*) feeding on a Pacific halibut (*Hippoglossus stenolepis*). Marine Mammal Science 22(1):198-200.
- Julian, F. and M. Beeson. 1998. Estimates of marine mammal, turtle, and seabird mortality for two California gillnet fisheries: 1990-1995. Fishery Bulletin 96(2):271-284.

- Kajimura, H. 1984. Opportunistic feeding of the northern fur seal, *Callorhinus ursinus*, in the eastern North Pacific Ocean and eastern Bering Sea. U.S. Dept. of Commerce, National Marine Fisheries Service. Seattle. 52 pp.
- Kasuya, T. 2002. Giant beaked whales, *Berardius bairdii* and *B. arnuxii*. In: Perrin, W.F., B. Wursig, and J.G.M. Thewissen. Encyclopedia of Marine Mammals. San Diego, CA: Academic Press. Pp. 519-522.
- Kelly, B.P. 1981. Pelage polymorphism in Pacific harbor seals. Canadian Journal of Zoology 59(7):1212-1219.
- Kenney, R.D. 2002. North Atlantic, North Pacific, and Southern right whales. In: Perrin, W.F., B. Wursig, and J.G.M. Thewissen. Encyclopedia of marine mammals. San Diego, CA: Academic Press. Pp. 806-813.
- Keynon, K.W. 1969. The sea otter of the eastern Pacific Ocean. North American Fauna 68:352.
- Kraus, S.D. 1990. Rates and potential causes of mortality in North Atlantic right whales (*Eubalaena glacialis*). Marine Mammal Science 6(4):278-291.
- Kruse, S. 1989. The behavior and ecology of Risso's dolphins (*Grampus griseus*) in Monterey Bay, California. In: 8th Biennial Conference on the Biology of Marine Mammals, Pacific Grove, CA. 36 pp.
- Lander, M.E., F.M.D. Gulland and R.L. Delong. 2000. Satellite tracking a rehabilitated Guadalupe fur seal (*Arctocephalus townsendi*). Aquatic Mammals 26:137-142.
- Leatherwood, S. 1974. Aerial observations of migrating gray whales, *Eschrichtius robustus*, off Southern California, 1969-72. Marine Fisheries Review 36(4):45-49.
- Leatherwood, S., R.R. Reeves, W.F. Perrin, and W.E. Evans. 1982. Whales, dolphins, and porpoises of the Eastern North Pacific and adjacent waters. A guide to their identification. US Dept. of Commerce, Springfield, VA. NOAA Technical Report NMFS Circular 444.
- Le Boeuf, B.J., D.P. Costa, A.C. Huntley, G.L. Kooyman and R.W. Davis. 1986. Pattern and depth of dives in northern elephant seals, *Mirounga angustirostris*. Journal of Zoology, London 208:1-7.
- Leduc, R. 2002. Delphinids, Overview. In: Perrin, W.F., B. Wursig, and J.G.M. Thewissen. Encyclopedia of marine mammals. San Diego, CA: Academic Press. Pp. 310-314.
- Lipsky, J.D. 2002. Right whale dolphins, *Lissodelphis borealis* and *L. peronii*. In: Perrin, W.F., B. Wursig, and J.G.M. Thewissen. Encyclopedia of marine mammals. San Diego, CA: Academic Press.
- Lowry, M.S., J.V. Carreta, and K. Forney. 2005. Pacific harbor seal, *Phoca vitulina richardsi*, census in California during May-June 2004. SWFSC Administrative Report LJ-05-06. 38.

- Lowry, M.S. and K.A. Forney. 2005. Abundance and distribution of California sea lions (*Zalophus californianus*) in central and Northern California during 1998 and summer 1999. *Fishery Bulletin* 103(2):331-343.
- Lowther, J.L. 2006. Genetic variation of coastal and offshore bottlenose dolphins, *Tursiops truncatus*, in the eastern North Pacific Ocean. M.S. Thesis, University of California. 126 pp.
- Macleod, C.D. and A. D'amico. 2006. A review of beaked whale behavior and ecology in relation to assessing and mitigating impacts of anthropogenic noise. *Journal of Cetacean Research and Management* 7(3):211-221.
- Masaki, Y. 1977. The separation of the stock units of sei whales in the North Pacific. Report of the International Whaling Commission Special Issue 1:71-79.
- Mate, B.R., B.A. Lagerquist, and J. Calambokidis. 1999. Movements of North Pacific blue whales during the feeding season off Southern California and their southern fall migration. *Marine Mammal Science* 15(4):1246-1257.
- Mehta, A.V., J.M. Allen, R. Constantine, C. Garrigue, B. Jann, C. Jenner, M.K. Marx, C.O. Matkin, D.K. Mattila, G. Minton, S.A. Mizroch, C. Olavarria, J. Robbins, K.G. Russell, R.E. Seton, G.H. Steiger, G.A. Vikingsson, P.R. Wade, B.H. Witteveen, and P.J. Clapham. 2007. Baleen whales are not important prey for killer whales *Orcinus orca* in high-latitude regions. *Marine Ecology Progress Series* 348:297-307.
- Melin, S.R. and R.L. Delong. 1999. Observations of a Guadalupe fur seal (*Arctocephalus townsendi*) female and pup at San Miguel Island, California. *Marine Mammal Science* 15(3):885-888.
- Mesnck, S.L., B.L. Taylor, B. Nachenberg, A. Rosenberg, S. Peterson, J. Hyde, and A.E. Dizon. 1999. Genetic relatedness within groups and the definition of sperm whale stock boundaries from the coastal waters off California, Oregon and Washington. M. E. Group. La Jolla SWFSC Administrative Report LJ-99-12. 10 pp.
- Monnet, C. and L. Rotterman. 1988. Sex related patterns in the post-natal development and survival of sea otters in Prince William Sound, Alaska. U.S. Dept. of the Interior, Los Angeles, CA. Population status of California sea otters. Pp. 162-190.
- Morton, A. B. 1990. A quantitative comparison of the behavior of resident and transient forms of the killer whale off the central British Columbia coast. Report of the International Whaling Commission Special Issue 12:245-248.
- Murison, L.D., D.J. Murie, K.R. Morin and J. Da Silva Curiel. 1984. Foraging of the gray whale along the West Coast of Vancouver Island, British Columbia. In: Jones, M.L., S.L. Swartz, and S. Leatherwood. *The Gray Whale, Eschrichtius robustus*. Orlando, FL: Academic Press. Pp. 451-463.

- Nerini, M. 1984. A review of gray whale feeding ecology. In: Jones, M.L., S.L. Swartz, and S. Leatherwood. *The Gray Whale, Eschrichtius robustus*. Orlando, FL: Academic Press. Pp. 423-450.
- Norris, K.S. and J.H. Prescott. 1961. Observations on Pacific cetaceans of California and Mexican waters. *University of California Publications in Zoology* 63(4):291-401.
- O'Corry-Crowe, G.M., K.K. Martien and B.L. Taylor. 2003. The analysis of population genetic structure in Alaskan harbor seals, *Phoca vitulina*, as a framework for the identification of management stocks. Southwest Fisheries Science Center, NOAA. La Jolla SWFSC Administrative Report LJ-03-08. 64 pp.
- Oleson, E.M., J. Calambokidis, J. Barlow and J.A. Hildebrand. 2007a. Blue whale visual and acoustic encounter rates in the Southern California Bight. *Marine Mammal Science* 23(3):574-597.
- Oleson, E.M., S. Wiggins, and J. Hildebrand. 2007b. Temporal separation of blue whale call types on a Southern California feeding ground. *Animal Behaviour* 74:881-894.
- Oliver, J.S. and P.N. Slattery. 1985. Destruction and opportunity on the sea floor: Effects of gray whale feeding. *Ecology* 66(6):1965-1975.
- Olson, P.A. and S.B. Reilly. 2002. Pilot whales, *Globicephala melas* and *G. macrorhynchus*. In: Perrin, W.F., B. Wursig, and J.G.M. Thewissen. *Encyclopedia of marine mammals*. San Diego, CA: Academic Press.
- Osborne, R.W., J. Calambokidis and E.M. Dorsey. 1988. *A Guide to marine mammals of Greater Puget Sound*. Anacortes, WA: Island Publishers. 191 pp.
- O'shea, T.J., R.L. Brownell, D.R. Clark, W.A. Walker, M.L. Gay and T.G. Lamong. 1980. Organochlorine pollutants in small cetaceans from the Pacific and South Atlantic Oceans, November 1968-June 1976. *Pesticides Monitoring Journal* 14:35-46.
- Perrin, W.F. 1982. Report of the workshop on identity, structure and vital rates of killer whale populations, Cambridge, England, June 23-25, 1981. *Report of the International Whaling Commission* 32:617-631.
- Perrin, W.F., M.D. Scott, G.J. Walker and V.L. Cass. 1985. Review of geographical stocks of tropical dolphins (*Stenella* spp. and *Delphinus delphis*) in the eastern Pacific. U S Dept. of Commerce. NOAA Technical Report NMFS 28. 28 pp.
- Perrin, W.F., B. Wursig and J.G.M. Thewissen. 2002. *Encyclopedia of marine mammals*. San Diego, CA: Academic Press.
- Pike, G.C. 1962. Migration and feeding of the gray whale (*Eschrichtius gibbosus*). *Journal of the Fisheries Research Board of Canada* 19(5):815-838.

- Pike, G.C. and I.B. Macaskie. 1969. Marine mammals of British Columbia. Bulletin of the Fisheries Research Board of Canada 171:1-54.
- Pitman, R.L. 2002. Mesoplodont whales In: Perrin, W.F., B. Wursig, and J.G.M. Thewissen. Encyclopedia of marine mammals. San Diego, CA: Academic Press. Pp. 738-742.
- Pitman, R.L., L.T. Ballance, S.I. Mesnick, and S.J. Chivers. 2001. Killer whale predation on sperm whales: Observations and implications. Marine Mammal Science 17(3):494-507.
- Pollock, G.A., I.J. Uhaa, A.M. Fan, J.A. Wisniewski, and I. Witherell. 1991. A study of chemical contamination of marine fish from Southern California. II. Comprehensive study. C. E. P. Agency. Sacramento.
- Rathbun, G.A., J. Estes and R.L. Brownell. 1989. Reintroduction of sea otters to San Nicolas Island, California. In: Eighth Biennial Conference on the Biology of Marine Mammals, Pacific Grove, CA.
- Reeves, R.R. 1992. Whale responses to anthropogenic sounds: A literature review. New Zealand Dept. of Conservation. Wellington, New Zealand.
- Reeves, R.R., B.S. Stewart and S. Leatherwood. 1992. The Sierra Club handbook of seals and sirenians. San Francisco, CA: Sierra Club Books. 359 pp.
- Reidman, M.L. and J. Estes. 1990. The sea otter (*Enhydra lutris*): Behavior, ecology, and natural history. U.S. Dept. of the Interior. Washington DC. U.S. Fish and Wildlife Biological Report 90 -41. Pp. 1-126.
- Reilly, S.B. and V.G. Thayer. 1990. Blue whale (*Balaenoptera musculus*) distribution in the Eastern Tropical Pacific. Marine Mammal Science 6(4):265-277.
- Rice, D.W. 1963. Progress report on biological studies on the larger Cetacea in the waters off California. Norsk Hvalfangst-tidende 7:181-187.
- Rice, D.W. 1974. Whales and whale research in the eastern North Pacific. In: W.E. Shevill. The whale problem. Cambridge, MA: Harvard University Press. Pp. 170-175.
- Rice, D.W. 1978. The humpback whale in the North Pacific: Distribution, exploitation and numbers. U. S. M. M. Commission. Washington, DC. Pp. 29-44.
- Rice, D.W. and C.H. Fiscus. 1968. Right whales in the southeastern North Pacific. Norsk Hvalfangst-tidende 57(5):105-107.
- Rice, D.W. and A.A. Wolman. 1971. Life History and Ecology of the Gray Whale (*Eschrichtius robustus*). American Society of Mammalogists. 142 pp.
- Rice, D.W. and A.A. Wolman. 1982. Whale census in the Gulf of Alaska, June to August 1980. Report of the International Whaling Commission 32:491-497.

- Rice, D.W., A.A. Wolman and H.W. Braham. 1984. The gray whale, *Eschrichtius robustus*. Marine Fisheries Review 46(4):7-14.
- Rivers, J.A. 1997. Blue whale, *Balaenoptera musculus*, vocalizations from the waters off central California. Marine Mammal Science 13(2):186-195.
- Rosel, P.E., A.E. Dizon and J.E. Heyning. 1994. Genetic analysis of sympatric morphotypes of common dolphins (genus *Delphinus*). Marine Biology 119(2):159-167.
- Rosenbaum, H.C., R. L. Brownell, M.W. Brown, C. Schaeff, V. Portway, B.N. White, S. Malik, L.A. Pastene, N. Patenaude and C.S. Baker. 2000. World-wide genetic differentiation of *Eubalaena*: Questioning the number of right whale species. Molecular Ecology 9(11):1793-1802.
- Ross, H.M. 1984. The smaller cetaceans of the south east coast of southern Africa. Annals of the Cape Provincial Museums (Natural History) 15(2):173-410.
- Rugh, D.J., R.C. Hobbs, J.A. Lerczak and J.M. Breiwick. 2005. Estimates of abundance of the eastern North Pacific stock of gray whales (*Eschrichtius robustus*) 1997-2002. Journal of Cetacean Research and Management 7(1):1-12.
- Scarff, J.E. 1991. Historic distribution and abundance of the right whale (*Eubalaena glacialis*) in the North Pacific, Bering Sea, Sea of Okhotsk and Sea of Japan from the Maury whale charts. Report of the International Whaling Commission 41:467-489.
- Scheffer, V.B. and J.W. Slipp. 1944. The harbor seal of Washington state. American Midland Naturalist 32(2):373-416.
- Seagers, D.J. and J.R. Henderson. 1985. Cephalopod remains from the stomach of a short-finned pilot whale collected from near Santa Catalina Island, California. Journal of Mammalogy 66:777-779.
- Shane, S.H. and D. Mcsweeney. 1990. Using photo-identification to study pilot whale social organization. Report of the International Whaling Commission Special Issue 12:259-263.
- Sinclair, E.H. 1994. Prey of juvenile northern elephant seals (*Mirounga angustirostris*) in the Southern California Bight. Marine Mammal Science 10 (2):230-239.
- Siniff, D.B. and K. Ralls. 1988. Status of California sea otters. U.S. Dept. of the Interior, MMS, Los Angeles, CA. Pp. 13-32.
- Soldevilla, M.S., S.M. Wiggins, J. Calambokidis, A.B. Douglas, E.M. Oleson and J.A. Hildebrand. 2006. Marine mammal monitoring and habitat investigations during CalCOFI surveys. California Cooperative Oceanic Fisheries Investigations Reports 47:79-91.
- Springer, A.M., J.A. Estes, G.B. Van Vliet, T.M. Williams, D.F. Doak, E.M. Danner, K.A. Forney and B. Pfister. 2003. Sequential megafaunal collapse in the North Pacific Ocean: An

- ongoing legacy of industrial whaling? Proceedings of the National Academy of Sciences 100(21):12223-12228.
- Stafford, K.M., S.L. Niekirk and C.G. Fox. 1999. An acoustic link between blue whales in the eastern tropical Pacific and the northeast Pacific. (*Balaenoptera musculus*). Marine Mammal Science 15(4):1258-1268.
- Stafford, K.M., S.L. Niekirk and C.G. Fox. 2001. Geographic and seasonal variation of blue whale calls in the North Pacific. (*Balaenoptera musculus*). Journal of Cetacean Research and Management 3(1):65-76.
- Steiger, G.H. and J. Calambokidis. 2000. Reproductive rates of humpback whales off California. (*Megaptera novaeangliae*). Marine Mammal Science 16(1):220-239.
- Steiger, G.H., J. Calambokidis, J.M. Straley, L.M. Herman, S. Cerchio, D.R. Salden, J. Urban-R.J.K. Jacobsen, O. Von Ziegesar and K.C. Balcomb. 2008. Geographic variation in killer whale attacks on humpback whales in the North Pacific: Implications for predation pressure. Endangered Species Research 4(3):247-256.
- Stevens, T.A., D.A. Duffield, E.D. Asper, K.G. Hewlett, A. Bolz, L.J. Gage and G.D. Bossard. 1989. Preliminary findings of restriction fragment differences in mitochondrial DNA among killer whales (*Orcinus orca*). Canadian Journal of Zoology 67(10):2592-2595.
- Stewart, B.S. 1987. Aerial surveys for cetaceans in the former Akutan, Alaska, whaling grounds. Arctic 40(1):33-42.
- Stewart, B.S. and R.L. Delong. 1990. Sexual differences in migrations and foraging behavior of northern elephant seals. American Zoologist 30:44A.
- Stewart, B.S. and H.R. Huber. 1993. *Mirounga angustirostris*. Mammalian Species 449:1-10.
- Stewart, B.S., P.K. Yochem, R.L. Delong, and G.A. Antonelis. 1987. Interactions between Guadalupe fur seals and California sea lions ant San Nicolas and San Miguel islands, California. In: Croxall, J.P. and R.L. Gentry. Status, biology, and ecology of fur seals. Proceedings of an international symposium and workshop, Cambridge, England. National Technical Information Service. NOAA Technical Report NMFS 51:103-106.
- Stewart, B.S., P.K. Yochem, H.R. Huber, R.L. Delong, R.J. Jameson, W.J. Sydeman, S.G. Allen and B.J. Le Boeuf. 1994. History and present status of the northern elephant seal population. In: Le Boeuf, B.J. and R.M. Laws. Elephant seals: Population ecology, behavior and physiology. Berkeley: University of California Press. Pp. 29-48.
- Stroud, R.K., C.H. Fiscus and H. Kajimura. 1981. Food of the Pacific white-sided dolphin, *Lagenorhynchus obliquidens*, Dall's porpoise, *Phocoenoides dalli*, and northern fur seal, *Callorhinus ursinus*, off California and Washington. Fishery Bulletin 78:951-959.

- Sumich, J.L. and J.T. Harvey. 1986. Juvenile mortality in gray whales (*Eschrichtius robustus*). *Journal of Mammalogy* 67(1):179-182.
- Taylor, B., J. Barlow, R. Pitman, L. Ballance, T. Klinger, D. Demaster, J. Hildebrand, J. Urban, D. Palacios and J. Mead. 2004. A call for research to assess risk of acoustic impact on beaked whale populations. In: Scientific Committee at the 56th Meeting of the International Whaling Commission, 29.
- Tempte, J.L. 1994. Photoperiod control of birth timing in the harour seal (*Phoca vitulina*). *Journal of Zoology, London* 233:369-384.
- Tershy, B.R., D. Breese and C.S. Strong. 1990. Abundance, seasonal distribution and population composition of balaenopterid whales in the Canal de Ballenas, Gulf of California, Mexico. Report of the International Whaling Commission Special Issue 12:369-375.
- Trites, A.W. and C.P. Donnelly. 2003. The decline of Steller sea lions *Eumetopias jubatus* in Alaska: A review of the nutritional stress hypothesis. *Mammal Review* 33(1):3-28.
- Turnock, B.J. and Quinn, II, T.J. 1991. The effect of responsive movement on abundance estimation using line transect sampling. *Biometrics* 47: 701-715.
- Wade, L.S. and G.L. Friedrichsen. 1979. Recent sightings of the blue whale, *Balenoptera musculus*, in the northeastern tropical Pacific. *Fishery Bulletin* 76(4):915-919.
- Wade, P., M.P. Heide-Jorgensen, K. Shelden, J. Barlow, J.V. Carretta, J. Durban, R. Leduc, L. Munger, S. Rankin, A. Sauter and C. Stinchcomb. 2006. Acoustic detection and satellite-tracking leads to discovery of rare concentration of endangered North Pacific right whales. *Biology Letters* 2:417-419.
- Wade, P.R. and T. Gerrodette. 1993. Estimates of cetacean abundance and distribution in the eastern Tropical Pacific. Report of the International Whaling Commission 43:477-493.
- Waerebeek, K.V. and B. Wursig. 2002. Pacific white-sided dolphin and dusky dolphin. In: Perrin, W.F., B. Wursig, and J.G.M. Thewissen. *Encyclopedia of marine mammals*. San Diego, CA: Academic Press.
- Wagemann, R. and D.C.G. Muir. 1984. Concentrations of heavy metals and organochlorines in marine mammals of northern waters: Overview and evaluation. C.F.a.A. Sciences. Canadian Technical Report 1279. 97 pp.
- Walker, W.A. 1981. Geographical variation in morphology and biology of bottlenose dolphins (*Tursiops*) in the eastern North Pacific. U.S. Dept. of Commerce. La Jolla SWFSC Administrative Report LJ-81-03C. 52 pp.
- Walker, W.A., K.R. Goodrich, S. Leatherwood and R.K. Stroud. 1984. Population biology and ecology of the Pacific white-sided dolphin, *Lagenorhynchus obliquidens*, in the northeastern

- Pacific. Part II: Biology and geographical variation. U.S. Dept. of Commerce. SWFSC Administrative Report LJ-84-34C. 43 pp.
- Walker, W.A., M.B. Hanson, R.W. Baird and T.J. Guenther. 1998. Food habits of the harbor porpoise, *Phocoena phocoena*, and Dall's porpoise, *Phocoenoides dalli*, in the inland waters of British Columbia and Washington. U.S. Dept. of Commerce, National Marine Fisheries Service. AFSC Processed Report 98-10. Pp. 63-75.
- Walker, W.A. and L.L. Jones. 1993. Food habits of northern right whale dolphin, Pacific white-sided dolphin, and northern fur seal caught in the high seas driftnet fisheries of the North Pacific Ocean, 1990. International North Pacific Fisheries Commission Bulletin 53 (II):285-295.
- Walker, W.A., S. Leatherwood, K.R. Goodrich, W.F. Perrin and R.K. Stroud. 1986. Geographical variation and biology of the Pacific white-sided dolphin, *Lagenorhynchus obliquidens*, in the north-eastern Pacific. In: Bryden, M.M. and R.J. Harrison. Research on Dolphins. Oxford University Press, Oxford, England. Pp. 441-465.
- Weitkamp, L.A., R.C. Wissmar, C.A. Simenstad, K.L. Fresh and J.G. Odell. 1992. Gray whale foraging on ghost shrimp (*Callinassa californiensis*) in littoral sand flats of Puget Sound, USA. Canadian Journal of Zoology 70(11):2275-2280.
- Weller, D.W. 2002. Predation on marine mammals. In: Perrin, W.F., B. Wursig, and J.G.M. Thewissen. Encyclopedia of marine mammals. San Diego, CA: Academic Press. Pp. 985-994.
- Wells, R.S., L.J. Hansen, A. Baldrige, T.P. Dohl, D.L. Kelly, and R.H. Defran. 1990. Northward extension of the range of bottlenose dolphins along the California coast. In: Leatherwood, S. and R.R. Reeves. The Bottlenose Dolphin. San Diego, CA: Academic Press. Pp. 421-431.
- Westlake, R.L. and G.M. O'corry-Crowe. 2002. Macrogeographic structure and patterns of genetic diversity in harbor seals (*Phoca vitulina*) from Alaska to Japan. Journal of Mammalogy 83(4):1111-1126.
- Whitehead, H. 2002. Sperm whale, *Physeter macrocephalus*. In: Perrin, W.F., B. Wursig, and J.G.M. Thewissen. Encyclopedia of marine mammals. Burlington, MA: Academic Press. Pp. 1165-1172.
- Willis, P.M., B.J. Crespi, L.M. Dill, R.W. Baird and M. B. Hanson. 2004. Natural hybridization between Dall's porpoises (*Phocoenoides dalli*) and harbour porpoises (*Phocoena phocoena*). Canadian Journal of Zoology 82(5):828.
- Woodhouse, C.D. and J. Stricklely. 1982. Sighting of northern right whale (*Eubalaena glacialis*) in the Santa Barbara Channel. Journal of Mammalogy 63(4):701-702.

York, A.E. and J.R. Hartley. 1981. Pup production following harvest of female northern fur seals. *Canadian Journal of Fisheries and Aquatic Sciences* 38:84-90.

11. ECOSYSTEM INTERRELATIONSHIPS

The Southern California Bight is an eastern boundary current system characterized by seasonal upwelling and high productivity. This productivity is connected to a wide variety of habitats and organisms found within the bight. While most of the productivity remains in the bight and immediately adjacent areas, some of this production can be transported to other areas via the California Current System.

11.1 COMPARISON OF TROPHIC LEVEL PRODUCTIVITY AMONG AREAS

The productivity of the Southern California Bight is well documented by scientists and well utilized by migratory species. There are many species of long-lived animals that visit this area and feast on the seasonal productivity as part of a larger migration around the Pacific basin. A comparison of eastern boundary currents between the Pacific and Atlantic basins showed that Pacific currents supported half as much biomass as that found in the Atlantic, likely due to higher nutrient concentrations in the Atlantic (Carr and Kearns 2003). Across the entire latitudinal spectrum of the California Current there is low primary production October through March, around 1-1.5 grams of carbon per square meter per day ($\text{g C/m}^2/\text{d}$), while the summer season supports higher productions, 1.5-5 $\text{g C/m}^2/\text{d}$ (Carr and Kearns 2003). The Southern California Bight, located between latitudes 32° N and 34° N, has more constant but lower overall productivity than other sections of the California Current System. The peak production season occurs April through June, averaging around 2.5 $\text{g C/m}^2/\text{d}$ (Carr and Kearns 2003).

11.1.1 Ecosystem Food Chains and Energy Transfer

The marine food web is complex and contains many interactions as all species are suspended in the same aqueous environment. The transfer of energy from one trophic level to another is poor and often assumed to be around 10 percent of what was produced at the lower level. In practice, efficiency varies with trophic level and species; smaller organisms tend to have better efficiency whereas larger or more complex organisms tend to be poorer at transferring energy efficiently and/or have high energy needs for maintaining internal temperatures (e.g., homeotherms) (French-McCay and Rowe 2003). This means that the farther up the food web an organism is found, the more biomass it must consume in order to fulfill energy requirements. This relationship results in higher biomass of lower-level-organisms and smaller biomass of higher-trophic-level organisms.

11.1.2 Ratios of Production at Different Trophic Levels

Annual primary production is on the order of 1,800 kilocalories per square meter ($\text{kcal/m}^2/\text{yr}$), of which phytoplankton generates the majority at 1,600 $\text{kcal/m}^2/\text{yr}$ (Hood 1993; i.e. 144 $\text{g C/m}^2/\text{yr}$, assuming 5 kcal/g dry weight and dry weight as 45 percent C; Odum 1971). Zooplankton produces only about a tenth of what is produced at the first trophic level, just over 200 $\text{kcal/m}^2/\text{yr}$ (Hood 1993). Bacteria generates a large amount, around 40 percent of that of primary production, at 730 $\text{kcal/m}^2/\text{yr}$ (Hood 1993). Benthos and fish produce relatively small amounts, less than 5 percent, at 63 and 72 $\text{kcal/m}^2/\text{yr}$, respectively. Organisms at the higher trophic levels account for only a fraction of the overall productivity of the system; birds produce only 0.012 $\text{kcal/m}^2/\text{yr}$ and mammals produce between 1.3 and 2 $\text{kcal/m}^2/\text{yr}$ (Hood 1993).

11.2 COMMUNITY ECOLOGY

As mentioned previously, the Southern California Bight occurs at a transition zone between the Oregonian and Californian biogeographical provinces (Blanchette et al. 2008). The demarcation between these is never exact and can move in and out of the bight on seasonal, yearly, and decadal time scales. Organisms found in the Oregonian province generally prefer colder conditions than those found in the Californian; however, near the transition zones organisms have adapted to tolerate some variation in environmental conditions. This creates a unique community of organisms and habitats in the Southern California Bight, with high species diversity.

The diversity in a community is created by a combination of life history strategies and interspecies interactions. Life history strategies are generally either to produce as many offspring as possible with little nurturing support (invertebrates, most fish, and sea turtles) or to provide a lot of parental care in raising a few offspring (some fish, birds and mammals). Under varying environmental conditions each of these strategies can be successful. Interspecies interactions, including competition, predation, commensalisms, and parasitism, also help to support diversity by promoting competitive evolution.

Species diversity has been linked to increased ecosystem productivity, suggesting more diverse communities have higher overall production (Stachowicz et al. 2007). High biodiversity can also help protect ecosystems against disturbances. High biodiversity suggests that these ecosystems support both generalist and specialist organisms, which thrive under different conditions and can help promote the growth of the other. Stachowicz et al. (2007) summarizes several studies where macroalgal communities with higher biodiversity have shown faster recovery rates or higher initial resiliency after being degraded by different types of disturbances.

11.2.1 Island Biogeography Theory

One concept of population biology is the island biogeography theory, which states that the number of species found on an island is determined by the immigration, emigration, and extinction rates of that island. The definition of island encompasses any fragment of habitat, natural or artificial, on which a community of living things persists (MacArthur and Wilson 1967). In the context of coastal development, installation of new structures creates new habitat, which can greatly alter the distribution of many organisms.

Many environmental factors contribute to the number of species found on an island, including the size of the island, its proximity to its nearest neighbor, and the location within natural dispersion forces (i.e. winds, currents). In a highly active aqueous environment the dispersion potential is quite high. The California Current System stretches along the entire coast of North America and therefore has the potential to carry species well beyond their natural ranges. The differences in environmental conditions along the California Current System generally keep the species communities from becoming ubiquitous; however, the mechanism is strong enough to create opportunities for invasive species to spread great distances. Invasions of the northeast Pacific are summarized in Wonham and Carlton (2005).

11.3 SUMMARY AND DATA GAPS

Whole ecosystem evaluations are uncommon because they require large data sets taken over many years to make analysis worthwhile. This is a time consuming and expensive procedure. The Southern California Bight has been relatively well studied by projects including the California Cooperative Oceanic Fisheries Investigation (CalCOFI) and the work done by the Channel Islands Marine Sanctuary. Continuation of these valuable studies will allow monitoring and analysis of the effects of climate change and further development of offshore oil and gas.

11.4 LIST OF LITERATURE CITED—ECOSYSTEM INTERRELATIONSHIPS

- Blanchette, C.A., C.M. Miner, P.T. Raimondi, D. Lohse, K.E.K. Heady and B.R. Broitman. 2008. Biogeographical patterns of rocky intertidal communities along the Pacific Coast of North America. *Journal of Biogeography* 35:1593-1607.
- Carr, M.E. and E.J. Kearns. 2003. Production regimes in four Eastern Boundary Current systems. *Deep-Sea Research II* 50: 3199-3221.
- French-McCay, D. and J.J. Rowe. 2003. Habitat restoration as mitigation for lost production at multiple trophic levels. *Marine Ecology Progress Series* 264:233-247.
- Hood, D.W. 1993. Ecosystem Interrelationships. In: Dailey, M., D. Reish, and J. Anderson. *Ecology of the Southern California Bight: A synthesis and interpretation*. University of California Press, Berkeley. 926 pp.
- MacArthur, R.H. and E.O. Wilson. 1967. *The theory of island biogeography*. Princeton, NJ: Princeton University Press. 203 pps.
- Odum, E.P. 1971. *Fundamentals of ecology*. Philadelphia: W.B. Saunders Co. 574 pp.
- Stachowicz, J.J., J.F. Bruno and J.E. Duffy. 2007. Understanding the effects of marine biodiversity on communities and ecosystems. *Annual Review of Ecology, Evolution, and Systematics* 38:739-766.
- Wonham, M.J. and J.T. Carlton. 2005. Trends in marine biological invasions at local and regional scales: The Northeast Pacific Ocean as a model system. *Biological Invasions* 7(3):369-392.

12. AREAS OF SPECIAL CONCERN

At present, nearly 50 Marine Protected Areas have been identified for the Pacific Region. National marine sanctuaries, national parks, national wildlife refuges, national estuarine research reserves, and national estuary program estuaries within the Pacific Region that are considered Marine Protected Areas are discussed in the following sections. In addition, there are a number of coastal and aquatic reserves located along the Pacific Coast that are managed by State agencies or nongovernmental organizations.

12.1 MARINE SANCTUARIES

Only one of the five National Marine Sanctuaries established on the Pacific Coast is in the Southern Study Area: the Channel Islands National Marine Sanctuary. The Channel Islands National Marine Sanctuary includes the waters surrounding San Miguel, Santa Rosa, Santa Cruz, Anacapa, and Santa Barbara Islands to a distance of 6 nautical mi (10 km) offshore in the Santa Barbara Channel of California (Figure 12.1). Within the sanctuary, California Fish and Game created a network of Marine Protected Areas in 2002 (<http://channelislands.noaa.gov/>). Common habitats within the sanctuary include rocky and sandy beaches, rocky reefs, sandy bottom, kelp forests, and pelagic or open water habitat.

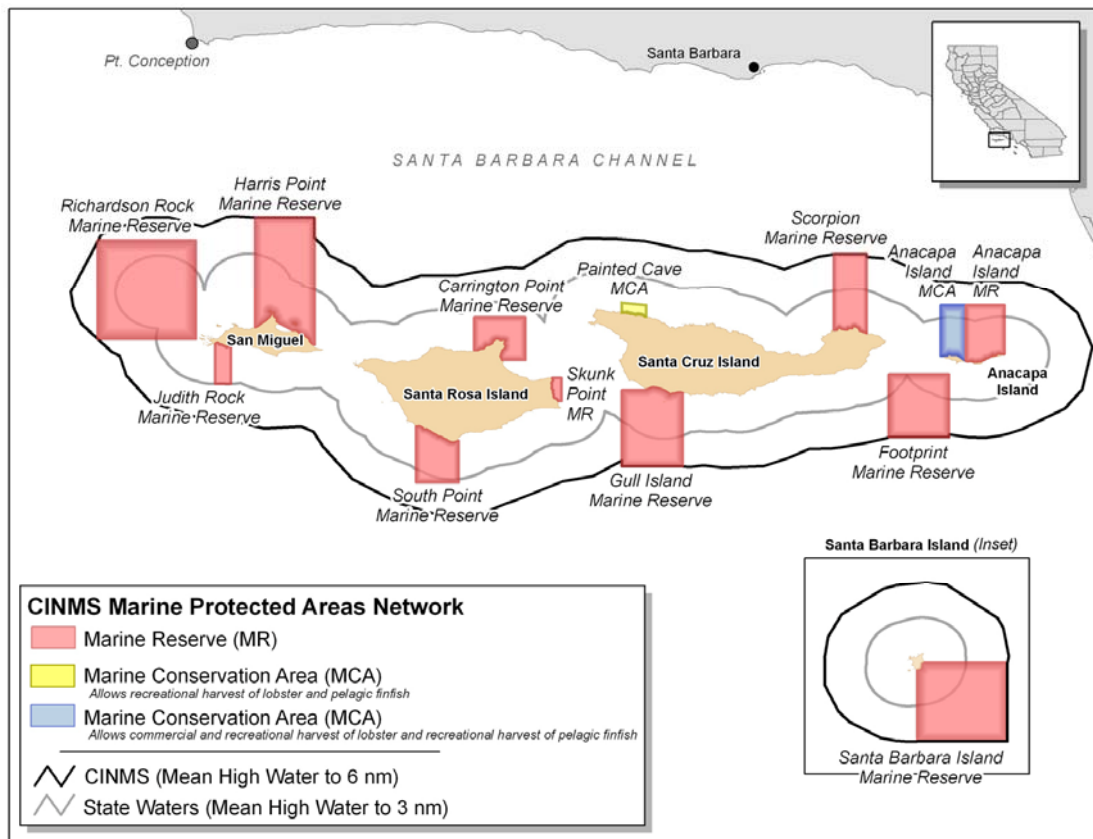

Figure 12.1. Map of the marine protected areas in the Channel Island National Marine Sanctuary

(<http://channelislands.noaa.gov/marineres/main.html>).

The combination of currents in the region results in a nutrient-rich environment that supports a great variety of plants and animals, including giant kelp and dense populations of fishes, invertebrates, cetaceans, pinnipeds, and marine birds. At least 27 species of whales and dolphins have been sighted in the Channel Islands National Marine Sanctuary, which lies in the migratory pathway of gray, humpback, and blue whales. The sanctuary also provides habitat for breeding populations of the California sea lion, the northern fur seal, the northern elephant seal, and the harbor seal. Of the 16 resident species of marine birds in the Southern California Bight, 11 breed in the sanctuary, including Xantus' murrelet, a federally listed threatened species, and the brown pelican, an endangered species.

12.2 NATIONAL PARK SYSTEM

The Channel Islands National Park comprises five Southern California islands. The park, which includes offshore waters for a distance of 1 nautical mile from the islands, encompasses an area of over 1,000 km² (386 mi²), half of which is under the ocean. Habitats within the park include kelp forests, seagrass beds, rock reefs, rock canyons, pelagic waters, coastal marshes and lagoons, sand beaches, sea cliffs, and rocky intertidal benches. Ecological resources in the park include large and diverse pinniped and seabird rookeries and at least 26 species of cetaceans. In addition, archaeological and cultural resources of the site span a period of more than 10,000 years.

12.3 NATIONAL WILDLIFE REFUGES

Twenty-eight national wildlife refuges located along the Pacific Coast have been designated as Marine Protected Areas. Most of these refuges were established to provide feeding, resting, and wintering areas for migratory waterfowl and shorebirds. Some of these refuges are of international importance, since they serve as stopover areas for Neotropical migrants, which travel to various parts of Central and South America. There are four refuges in the Southern Study Area which make up the San Diego Wildlife Refuge Complex: Seal Beach, San Diego Bay, San Diego, and Tijuana Slough (<http://www.fws.gov/sandiegorefuges/index.html>). These refuges were created to protect quality habitat for many threatened and endangered species including the California least tern, least Bell's vireo, light-footed clapper rail, brown pelican, western snowy plover, peregrine falcon, and Belding's savannah sparrow.

12.4 NATIONAL ESTUARINE RESEARCH RESERVES

One of the six national estuarine research reserves (NERRs) established in Pacific Region is located in the Southern Study Area. The Tijuana River NERR, established in 1982, is located just to the north of the United States-Mexico border and encompasses 2,500 acres (10.1 km²). Eight threatened and endangered species can be found within this saline marsh reserve: light-footed clapper rail, California least tern, Least Bell's vireo, salt marsh bird's beak, cordgrass, white and brown pelicans (<http://nerrs.noaa.gov/Reserve.aspx?ResID=TJR>).

12.5 NATIONAL ESTUARY PROGRAM

One of the six estuaries in the National Estuary Program established in Pacific Region is located in the Southern Study Area. Santa Monica Bay was established in the program in 1988 and consists of nearly 1,500 km². Threatened and endangered species found within the estuary

include: California least tern, California gnat catcher, brown pelican, peregrine falcon, western snowy plover, all four sea turtles (green, leatherback, loggerhead, olive ridley), steelhead trout, and salt marsh bird's beak (<http://www.epa.gov/owow/estuaries/>).

12.6 ARCHEOLOGICAL SITES (E.G. SHIPWRECKS)

The National Historic Preservation Act of 1966 (NHPA) created the National Register of Historic Places and charged the National Park Service with its management. The NHPA requires all Federal agencies to consider the effects of their actions on historic properties listed on or eligible for the National Register. Archaeological sites are protected under the NHPA.

The Southern California Bight and Southern California islands and coastal mainland have long been settled and explored by various groups of people. The Channel Islands National Marine Sanctuary is the site of over 140 documented aircraft and shipwrecks dating back to the 1542 voyage of explorer Juan Cabrillo; to date, only 20 have been located (USDOC, NOAA 2008). Shipwrecks include both older vessels and more modern cargo vessels including the *Pac Baroness*, which sank off Point Conception in 1987. This wreck still contains toxic substances and its effect on the surrounding environment is currently being researched (USDOC, NOAA 2008). A database of the older wrecks has been compiled by the Channel Island Marine Sanctuary (<http://channelislands.noaa.gov/shipwreck/cinms.html>).

Some of the oldest human remains found in North America were found on Santa Rosa Island. It is believed that the Chumash Native American cultures lived and traveled between the mainland and the Channel Islands up to 13,000 years before present. Submerged artifacts have been documented and described around the islands and in the Santa Barbara Channel (Hudson 1976; Hudson and Howorth 1985; Howorth and Hudson 1993).

12.7 WEAPONS AND CHEMICAL DUMPING GROUNDS

The United States Armed Forces were responsible for the dumping of chemical weapons off the coast of the United States from World War I through 1970. While most of the locations of these dumping grounds remain unknown, most of the dumping originated from San Francisco and is not likely to be found in the Southern Study Area (Bearden 2007). There are known disposal sites for chemical munitions and explosive materials within the Southern California Bight. Areas where use has discontinued include an area between Santa Catalina, San Clemente, and San Nichols Islands; the Santa Cruz Basin; and west of San Diego. Current explosive dumping grounds are found west of San Clemente Island and west of San Diego (USDOC, NOAA 1997).

Several hazardous wastes sites are located within the Southern Study Area. Several dumping grounds for dredged materials can be found within 5 miles offshore of San Diego, Los Angeles and Long Beach. A larger dumping ground is reported on the San Pedro Basin off the Palos Verde peninsula (USDOC, NOAA 1997). This location may still pose an environmental threat if the sediments are disturbed. The discharge millions of pounds of DDT and PCBs into the Southern California Bight during the 1960s and 1970s resulted in contamination of the sediments and ecosystem. In 2003, the United States Environmental Protection Agency (United States EPA) found high concentrations of these chemicals persisted in the sediments on the Palos

Verdes Shelf (USEPA 2003). A similar study of the fish in the area shows continued contamination of resident species (USDOC, NOAA 2007).

12.8 CALIFORNIA STATE PROTECTED AREAS

The State of California is currently working to establish a network of marine protected areas under the Marine Life Protection Act. The MPAs on the central coast were adopted in 2007, on the north central coast in 2009, and planning is currently occurring for both the north and south coast study areas. Another study area focused on San Francisco Bay will begin planning in 2010. A list of the proposed MPAs for each of the southern coastal counties can be found on the California Department of Fish and Game website (<http://www.dfg.ca.gov/mlpa/maps.asp>). Already established are the Channel Islands Marine Protected Areas which overlap with the Federal MPAs shown above ([Figure 12.1](#)). For a detailed description of the state waters of Southern California region (Point Conception to the Mexico border) please see the California Marine Life Protection Act Initiative: Regional Profile of the MLPA South Coast Study Region (http://www.dfg.ca.gov/mlpa/regionalprofile_sc.asp).

12.9 SUMMARY AND DATA GAPS

The Southern California Bight has been an active coastal zone for centuries. In recent decades much of the sensitive land and water has received protection in the form of sanctuaries and reserves. Similarly, artifacts of ancient and modern cultures can be found in this area and need to be protected and preserved. To prevent accidental disturbance of these sensitive areas they need to be accurately mapped. This can be a challenge as not all historical locations have been discovered.

12.10 LIST OF LITERATURE CITED—AREAS OF SPECIAL CONCERN

- Bearden, D.M. 2007. U.S. disposal of chemical weapons in the ocean: Background and issues for Congress. CRS Report for Congress. Order Code RL33432, updated January 3, 2007.
- Howorth, P.C. and D.T. Hudson. 1993. Submerged archaeological and historical sites in the Channel Islands National Park and Channel Islands National Marine Sanctuary. In: Hochberg, F.G., ed. Third California Islands Symposium. Recent Advances in Research on the California Islands. Santa Barbara Museum of Natural History, Santa Barbara, California.
- Hudson, D.T. 1976. Marine Archaeology along the Southern California Coast. San Diego Museum Papers, Number 9, San Diego Museum of Man, San Diego, California.
- Hudson, D.T. and P.C. Howorth. 1985. A preliminary report of sensitive marine archaeological and historical sites located within the boundary of the Channel Islands National Marine Sanctuary, Part one: Archaeological cultural resources. Prepared for Channel Islands National Marine Sanctuary and Channel Islands National Park, Ventura, California. Contract Nos. 8120-6100-454 and 8120-6100-454-2500.
- U.S. Dept. of Commerce, National Oceanic and Atmospheric Administration (NOAA), The National Ocean Service. 1997. Chart 18740: San Diego to Santa Rosa Island. BSB Electronic Charts 1995-1997.

U.S. Dept. of Commerce, National Oceanic and Atmospheric Administration (NOAA). 2007. 2002-2004 Southern California coastal marine fish contaminants survey. U.S. Environmental Protection Agency Region IX. San Francisco, CA.

U.S. Dept. of Commerce, National Oceanic and Atmospheric Administration (NOAA), National Marine Sanctuary Program. 2008. Channel Islands National Marine Sanctuary final management plan/final environmental impact statement. Silver Spring, MD.

U.S. Environmental Protection Agency (EPA). 2003. Ecological Risk Assessment for the Palos Verdes Shelf. U.S. EPA, Region IX. San Francisco, CA.

13. SOCIOECONOMIC RESOURCES

13.1 DEMOGRAPHIC

The National Ocean Economics Program (2008) provides a full range of the most current economic and socio-economic information available on changes and trends along the U.S. coast and in coastal waters. Based on population data gathered from the U.S. Census Bureau (2008a) by the National Ocean Economics Program, there were about 17 million persons living in the coastal counties of the Southern Study Area in 2007 ([Table 13.1](#)). Regional population grew at an annual average rate of 0.8 percent over the period 1990 through 2007. Within these coastal counties, the majority of the population is concentrated in Los Angeles County (9.9 million in 2007).

Table 13.1.

Socioeconomic Environment for the Coastal Region of Southern Study Area (millions), 1990 and 2007

County	1990			2007		
	Population	Employment	Wages ^a	Population	Employment	Wages ^a
Los Angeles	8.863	4.289	\$158,643.10	9.879	4.201	\$175,719.64
Orange	2.411	1.234	\$43,043.77	2.997	1.510	\$63,706.18
San Diego	2.498	1.001	\$31,550.03	2.975	1.321	\$52,296.18
Santa Barbara	0.370	0.166	\$5,027.20	0.404	0.187	\$6,534.21
Ventura	0.669	0.246	\$7,813.87	0.798	0.318	\$12,594.22
Total	14.81	6.936	\$246,077.97	17.053	7.537	\$310,850.42

^a Dollar values are converted to year 2000 equivalents.

Source: Data from U.S. Bureau of Labor Statistics (2008) and U.S. Census Bureau (2008a) compiled by National Ocean Economics Program (2008)

13.2 ECONOMIC DEVELOPMENT

The National Ocean Economics Program (2008) compiles demographic, market, natural resource, and government expenditure data for coastal and ocean economic geographies. Its Market Data site includes the following:

- **Ocean Economy Sector & Industry Data** includes six primary sectors of economic activity that derives all or part of its inputs from the ocean and/or Great Lakes. These economic activities are grouped into sectors and their component industries, as defined by NOEP, to delineate the Ocean Economy.
- **Coastal Economy Sector Data** consist of all economic activity in the coastal region from barber shops to surf shops. The industries that represent these activities are aggregated into the supersectors defined by the Bureau of Labor Statistics. These supersectors are available in different geographic subsets of the coastal region and comprise the NOEP Coastal Economy.

- **Geographic Regions** available in the Ocean Economy are the nation, and the thirty coastal states and their counties. The economic indicators of the ocean sectors and industries are derived from different geographic areas, depending on the industry definition and the resource classifications. Some sectors, such as Tourism & Recreation, are aggregated from Near Shore regions, while others depend on coastal counties for valuation. The Coastal Economy includes Near Shore areas as well as Shoreline, Coastal, and Watershed county aggregates.
- **Economic Indicators** found in the Ocean Economy and Coastal Economy data are the number of establishments, employment, wages, and State Gross Domestic Product (GDP).

Based on employment and wage data gathered from the U.S. Bureau of Labor Statistics (2008) by the National Ocean Economics Program (2008), employment in the coastal counties of the Southern Study Area was at 6.9 million in 2007 ([Table 13.1](#)). Wages in these coastal counties in year 2000 values rose from \$246.1 billion in 1990 to \$310.8 billion in 2007 (dollar values are converted to year 2000 equivalents). Employment is concentrated in Los Angeles County (4.2 million in 2007). There was some variation in per employee wages among the counties; in 2007, the nominal value of per employee wages ranged from \$50,812 in Orange County to \$41,967 in Santa Barbara County. The average for all coastal counties in the study area was \$49,655.

The export base of coastal counties in the Southern Study Area has been highly dependent on the tourism and hospitality industries. Technology is also a vital force in the regional economy, with several “clusters” of activity around the region’s universities. The military is a major force in San Diego County’s economy, with San Diego having the only large shipbuilding industry on the West Coast. There is still a significant agricultural presence in Ventura County and the northern portion of Santa Barbara County. Data gathered from the U.S. Bureau of Labor Statistics (2008) by the National Ocean Economics Program (2008) can be used to show the number of establishments in various economic sectors in Southern Study Area coastal counties in 2007 ([Table 13.2](#)).

Table 13.2.

Number of Establishments by Economic Sector in the Coastal Region of Southern Study Area, 2007

County	Total	Construction	Financial Activities	Education and Health Services	Information	Leisure and Hospitality	Manufacturing
Los Angeles	397,584	14,058	24,738	30,413	8,702	26,857	15,015
Orange	94,799	7,024	11,195	10,683	1,362	6,986	5,333
San Diego	91,960	7,139	9,792	8,665	1,287	6,851	3,195
Santa Barbara	13,637	1,170	1,207	1,521	227	1,161	449
Ventura	21,735	2,058	2,140	2,614	359	1,741	963
Total	619,715	31,449	49,072	53,896	11,937	43,596	24,955

Source: Data from U.S. Bureau of Labor Statistics (2008) compiled by National Ocean Economics Program (2008)

Table 13.2.

Number of Establishments by Economic Sector in the Coastal Region of Southern Study Area, 2007
(continued)

County	Natural Resources and Mining	Other Services	Professional and Business Services	Public Administration	Trade, Transportation, and Utilities	Unclassified
Los Angeles	520	176,532	42,631	894	54,995	2,234
Orange	202	14,180	18,966	295	17,719	855
San Diego	768	22,398	16,232	370	14,555	711
Santa Barbara	578	2,998	2,028	111	2,110	77
Ventura	642	3,375	3,647	144	3,900	155
Total	2,710	219,483	83,504	1,814	93,279	4,032

Source: Data from U.S. Bureau of Labor Statistics (2008) compiled by National Ocean Economics Program (2008)

Summary descriptions of the economies of coastal communities in California can be found in the community profiles prepared by Norman et al. (2008). The authors profile 125 communities that are significantly involved in commercial fisheries in the marine environs of Alaska, Washington, Oregon, and California, including state- and federally-managed waters along the coastlines of these states. The profiles are given in a narrative format that includes four sections. *People and Place* includes information on location, demographics (including age and gender structure of the population, racial and ethnic make up), education, housing, and local history. *Infrastructure* covers current economic activity, governance (including city classification, taxation, and proximity to fisheries management and immigration offices) and facilities (transportation options and connectivity, water, waste, electricity, schools, police, public accommodations, and ports). *Involvement in West Coast Fisheries* and *Involvement in North Pacific Fisheries* detail community activities in commercial fishing (processing, permit holdings, and aid receipts), recreational fishing, and subsistence fishing. The demographic and economic data presented in the profiles are primarily from the 2000 Census of Population and Housing conducted by the U.S. Census Bureau (2008a).

13.3 SOCIOCULTURAL SYSTEMS

The sociocultural environment includes social statuses and roles, groups, institutions, and the relations among them as well as cultural perceptions. In the largely urban environment of coastal Southern California, continuous urban development stretches from 50 km (31 mi) north of Los Angeles to San Diego. The large metropolitan areas of the Southern Study Area represent destinations of opportunity for many individuals, as evidenced by the diverse racial and cultural composition of the region's major cities (USDOJ, MMS 2007). Many of the smaller communities in the study area maintain sociocultural environments that are less diverse, often supporting a small number or a single cultural group in the most important community economic activity. Summary descriptions of the sociocultural systems of coastal communities in California can be found in Norman et al. (2006).

In Southern California, the intertidal zone is the object of intensive gathering activities by members of various ethnic groups (USDOJ, MMS 2007). The traditional Native American gathering in Southern California has been reduced in recent years because of a decrease in the supply of traditional plant and animal foods. The beach, coast, and the ocean itself exist as important geographic, spiritual, and socially constructed components for many Pacific Coast residents (USDOJ, MMS 2007). Recreation and tourism and ocean-related industries provide substantial income for local community economies. Additionally, the beach, the coast, and the ocean provide a “coastal connection” between residents and the sea. For example, a recent public poll showed the extraordinary value that a large majority of California residents place on the State’s beaches and ocean (Public Policy Institute of California 2003).

13.4 ENVIRONMENTAL JUSTICE

Under Executive Order 12898 all Federal agencies are required to determine if their actions will cause disproportionately high and adverse human health or environmental impacts to low-income, minority, or tribal populations. Such impacts can derive from physical or natural resource impacts that result in disproportionate social, cultural, or economic effects on these populations. Examples include visual changes in seascapes and construction of onshore facilities in areas that would mostly affect low-income or minority populations.

Data in [Table 13.3](#) and [Table 13.4](#) show the minority and low-income composition of populations in the coastal counties of the Southern Study Area for 2007 based on data compiled by the U.S. Census Bureau’s Population Estimates Program and Small Area Income and Poverty Estimates Program. The number of individuals in individual minority racial groups (Black or African American; American Indian and Alaska Native; Asian; and Native Hawaiian and Other Pacific Islander) is slightly underestimated because only race "alone" data (i.e., the number of persons in each racial category that indicated they were of one race only) are reported. Individuals identifying themselves as Hispanic or Latino are included in the table as a separate entry because these individuals can be of any race. To avoid double-counting, this number only includes individuals also identifying themselves as being white alone.

Table 13.3.

Minority Populations in the Coastal Region of Southern Study Area, 2007^a

State/ County	Total Population	Percent Minority	Black or African American		American Indian or Alaskan Native		Asian		Native Hawaiian or Other Pacific Islander		Hispanic or Latino	
Los Angeles	9,878,554	67.20%	867,400	8.8%	24,692	0.2%	1,272,878	12.9%	23,517	0.2%	4,454,559	45.1%
Orange	2,997,033	49.90%	47,836	1.6%	8,697	0.3%	476,921	15.9%	8,798	0.3%	951,986	31.8%
San Diego	2,974,859	44.10%	145,227	4.9%	15,928	0.5%	298,156	10.0%	12,419	0.4%	839,927	28.2%
Santa Barbara	404,197	43.10%	7,566	1.9%	2,229	0.6%	17,315	4.3%	677	0.2%	146,237	36.2%
Ventura	798,364	44.00%	13,899	1.7%	3,374	0.4%	51,177	6.4%	1,542	0.2%	281,107	35.2%
Total	17,053,007	58.50%	1,081,928	6.3%	54,920	0.3%	2,116,447	12.4%	46,953	0.3%	6,673,816	39.1%

a Races are one race alone. Hispanic or Latino are white alone.

Source: U. S. Census Bureau (2008a)

Table 13.4.

Low-income Populations in the Coastal Region of Southern Study Area, 2007

County	Poverty Estimate (all ages)	Percent Poverty
Los Angeles	1,423,245	14.6%
Orange	264,467	8.9%
San Diego	319,404	11.1%
Santa Barbara	47,490	12.2%
Ventura	68,653	8.7%
Total	2,123,259	12.4%

Source: U. S. Census Bureau (2008b)

[Table 13.3](#) shows that 62.8 percent of individuals in the coastal counties of the Southern Study Area identified themselves as minority, while [Table 13.4](#) shows that 12.4 percent of individuals had an annual income in 2007 at or below the poverty line. For the coastal counties in the study area as a whole, the percentage of individuals identifying themselves minority was considerably more than the nation as a whole (34.3 percent). The percentage of individuals below the poverty line was slightly less than in the United States as a whole (13.0 percent).

Within the Southern Study Area, there is a diversity of population groups. Metropolitan and larger urban areas have a wide variety of ethnic and racial groups, reflecting heterogeneous sociocultural systems, with cultural centers containing population groups of African, European, Asian, Native American, and Latin American origins. Smaller urban centers and rural areas of Ventura County and Santa Barbara County tend to be less diverse, with a smaller number of cultural and racial and ethnic groups present.

13.5 INFRASTRUCTURE AND SERVICES

Current offshore oil and gas production in the Southern Study Area is serviced from well-established ports, and these existing port facilities can be expected to accommodate the onshore support facilities required for new exploration and development in the study area. Data from the American Association of Port Authorities show that Los Angeles and Long Beach were among the 50 largest U.S. ports in 2007 in terms of cargo volume. [Table 13.5](#) lists the annual volume of goods shipped and received at major ports in the area. Another indication of port size and capabilities is the amount of vessel traffic as measured by the number of port calls. The U.S. Maritime Administration provides estimates of the number port calls by port and commercial vessel type in the Southern Study Area ([Table 13.6](#)). All of the major ports in the study area are connected to well-developed land transportation networks, including rail and highway.

Table 13.5.

Cargo Volume by Port in the Coastal Region of Southern Study Area, 2007

U.S. Rank	Port	Metric Tons
5	Long Beach	72,634,772
14	Los Angeles	47,111,673
99	San Diego	2,818,833
138	Port Hueneme	1,191,879

Source: American Association of Port Authorities (2008); U.S. Army Corps of Engineers (2008)

Table 13.6.

Port Calls by Port and Commercial Vessel Type in the Coastal Region of Southern Study Area, 2007

Port	All Types Calls	Tanker Calls	Container Calls	Dry Bulk Calls	Ro-Roc Calls	Gas Carrier Calls	Combination Calls	General Cargo Calls
LA/Long Beach	5,178	1,070	2,812	640	345	2	13	296
Port Hueneme	397	16	0	0	218	0	0	163
San Diego	319	1	52	45	178	0	0	43
El Segundo	245	245	0	0	0	0	0	0
S. California lightering area	24	24	0	0	0	0	0	0

Source: U.S. Maritime Administration (2008)

Vessels using the above ports may include military craft (U.S. Navy and U.S. Coast Guard), commercial business craft (freighters, tug boats, fishing vessels, ferries, and cruise passenger ships), commercial recreational craft (cruise ships and fishing/sight-seeing charters), research vessels, and personal craft (fishing boats, house boats, yachts, and other pleasure craft) (USDOJ, MMS 2007). While many of these vessels generally remain within State waters (i.e., near shore), such as most ferries and personal craft, they influence the availability of port facilities and impact vessel traffic near ports in areas that might be considered for alternative offshore energy projects.

13.6 VISUAL RESOURCES

The broad sandy beaches of the Southern Study Area are heavily used for recreation because of their proximity to large urban areas and the warm and sunny climate (USDOJ, MMS 2007). Recreational boating is also an important activity in coastal waters of Southern California. The number of potential viewers and the recreational nature of the activities they are engaged in make viewsheds from beaches particularly sensitive to offshore impacts. In addition, in some areas residences are located at or very close to the shore; many people choose to live in these areas because of the ocean views from their homes or nearby ocean front. Seaside residents would potentially be very sensitive to changes visible from the shore, and hence viewsheds from seaside residences are of particular concern for potential visual impacts (USDOJ, MMS 2007).

13.7 TOURISM AND RECREATION

The Southern Study Area includes approximately 480 km (300 mi) of coastline. The Pacific coastline is an outstanding natural resource of great variety, grandeur, contrast, and beauty. It is an important recreational asset to the residents and contributes to the economic success of the tourist industry (USDOJ, MMS 2007). The main recreation and tourism activities that could be affected by construction and operation of an offshore oil and gas facility would be beach recreation, surfing, sightseeing, diving, and recreational fishing. The extent of impacts would depend on the proximity of offshore oil and gas facilities and activities to recreational use areas. These impacts can be negative, such as visual effects and exposure of the coast to the danger of oil spills from an oil well blowout or a tanker accident, and positive, such as enhanced fishing opportunities for certain species that are attracted by the introduction of hard substrates.

Tourism is a major economic force for coastal counties in the Southern Study Area, and any negative changes in tourism will be of major concern. Arguably, while few tourism activities are coastal-dependent (that is, cannot occur without access to the coast), the majority are coastal-enhanced, for it is the coastal orientation of the counties that greatly contributes to the sense of place and the general ambiance so highly prized by visitors to the area (USDOJ, MMS 2001).

Dean Runyan Associates provides annual analyses of the economic impacts of travel to and through the counties of California. As shown in [Table 13.7](#), visitor spending in the coastal counties in the Southern Study Area totaled \$41.2 billion in 2007. Visitor expenditures are concentrated in Los Angeles County (\$19.5 billion in 2007) and San Diego County (\$10.7 billion). Travel also results in fiscal impacts in the form of State and local tax revenue. Tax receipts from travel in all the coastal counties in the study area totaled \$2.7 billion in 2007.

Table 13.7.

Economic Impacts of Travel in the Coastal Region of Southern Study Area (millions), 2007

County	Visitor Spending at Destination	Total Direct Tax Receipts (State and Local)
Los Angeles	\$19,500.00	\$1,350.70
Orange	\$8,304.10	\$541.60
San Diego	\$10,700.00	\$669.30
Santa Barbara	\$1,408.80	\$97.40
Ventura	\$1,305.50	\$80.30
Total	\$41,218.40	\$2,739.30

Source: Dean Runyan Associates (2008)

Based on data gathered from the U.S. Bureau of Labor Statistics (2008), the National Ocean Economics Program (2008) estimates employment and wages in the ocean-related sectors in which tourism and recreation expenditures occur ([Table 13.8](#)). In the coastal counties of the Southern Study Area, these wages totaled \$2.1 billion in 2003, the most recent year for which data are available. Employment is concentrated in San Diego County (53.6 thousand in 2003) and Orange County (27.7 thousand). The ocean-related tourism and recreation employment for

all coastal counties in the Southern Study Area was 117.0 thousand in 2003. The multiplier effect is also estimated by the National Ocean Economics Program using IMPLAN, a social accounting and impact analysis software. In 2003, the total (direct, indirect, and induced) ocean-related tourism and recreation employment for all coastal counties in the study area was 159.9 thousand, while the total wages was \$3.5 billion.

Table 13.8.

Employment and Wages in Ocean-Related Tourism and Recreation Sector in the Coastal Region of Southern Study Area, 2003

County	Employment (thousands)	Employment with Multipliers (thousands)	Wages (millions)	Wages with Multipliers (millions)
Los Angeles	14.89	20.34	\$270.75	\$444.97
Orange	27.73	37.88	\$515.24	\$846.79
San Diego	53.6	73.24	\$1,039.68	\$1,708.72
Santa Barbara	12.74	17.41	\$214.39	\$352.35
Ventura	8.05	10.99	\$113.48	\$186.51
Total	117.01	159.87	\$2,153.54	\$3,539.34

Source: Data from U.S. Bureau of Labor Statistics (2008) compiled by National Ocean Economics Program (2008)

The UCSB Economic Forecast Project (2010) also quantifies the importance of tourism to the Santa Barbara, San Luis Obispo, and Ventura counties area. The Economic Outlooks are the major annual publication of the Economic Forecast Project. Indicators of tourism published in the Economic Outlooks include total visitor expenditures, overnight visitor expenditures, daily visitor expenditures, hotel occupancy rate, total visitors per day, and percentage of county workforce employed in tourism and lodging segments.

13.8 MILITARY USE AREAS

Military use areas, established in numerous areas off all U.S. coastlines, are required by the U.S. Air Force, Navy, Marine Corps, and Special Operations Forces to conduct various testing and training missions. Military activities can be quite varied but normally consist of various air-to-air, air-to-surface, and surface-to-surface naval fleet training, submarine and antisubmarine training, and air force exercises. Maps of military use areas in the Northern Study Area are available from NOAA ENC® Direct to GIS, a web portal managed by NOAA's Office of Coast Survey (2008).

A region in the Southern Study Area which is used intensively for military-related operations is the Point Mugu Sea Range (U.S. Department of the Navy 2002). The Point Mugu Sea Range is a 93,240 sq. km (36,000 sq. mi.) area of ocean and controlled airspace, roughly 322 km (200 nm) long (north to south) and extending west into the Pacific Ocean from its nearest point at the mainland coast (5 km [3 nm] at Ventura County) out to approximately 290 km (180 nm) offshore ([Figure 13.1](#)). The four OCS platforms (Harvest, Hermosa, Hidalgo, and Irene) located in Military Warning Area W-532 were installed in 1985 and 1986 (USDOI, MMS 2001). All of these OCS platforms are still in place and currently account for about 25 percent of the oil and 10

percent of the gas produced from the Pacific OCS. Platforms Harvest, Hermosa, and Hidalgo are projected to continue producing oil and gas until 2015. Oil and gas production at Platform Irene is projected to continue to 2020, but operations could be extended until 2030 if development of the Tranquillon Ridge Field by extended reach drilling is successful (USDOI, MMS 2001).

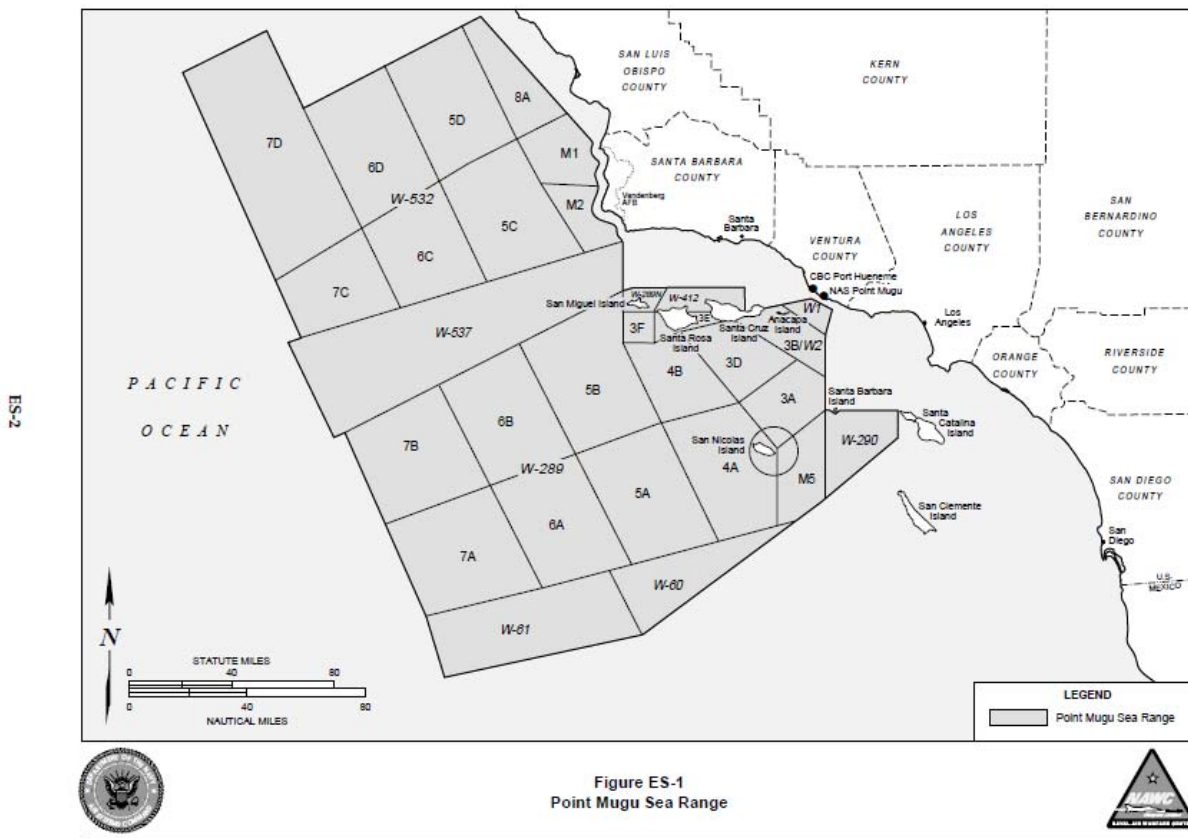

Figure 13.1. Location of Point Mugu Sea Range in Southern Study Area.
From U.S. Department of the Navy (2002)

13.9 COMMERCIAL AND RECREATIONAL FISHERIES

13.9.1 Commercial Fisheries

Information on commercial fish and shellfish landings in the Southern Study Area by weight and value is available from the California Department of Fish and Game (2008). These data are broken down by statistical area and port.

Commercial marine fishery landings for the State of California totaled 171 thousand tons, worth about \$120 million in 2007 (California Department of Fish and Game 2008). Commercial fish

landings for the geographical area that falls within the Southern Study Area totaled 110 thousand tons, valued at \$61 million.

For reported 2007 total landings value, 10 Pacific Coast ports fell within the top 50 United States ports (USDOC, National Marine Fisheries Service 2008). These ports reported landings worth more than \$240 million in 2007. The Southern Study Area had two ports that fell in the top 50: Port Hueneme, Oxnard, Ventura (\$27 million) and Los Angeles (\$19 million). In total, there were 23 ports that reported landings by species in the three statistical areas of Santa Barbara (6), Los Angeles (13) and San Diego (4) ([Table 13.9](#)).

Table 13.9.

Major Commercial Fishing Ports in California Statistical Areas in Southern Study Area, 2007

Statistical Areas		
Santa Barbara	Los Angeles	San Diego
Ventura	San Pedro	San Diego
Port Huenome	Terminal Island	Mission Bay
Santa Barbara Harbor	Dana Point	Oceanside
Oxnard	Newport Beach	Point Loma
Guadalupe Beach	Long Beach	
Surf Beard	Redondo Beach	
	Marina Del Rey	
	Avalon	
	Wilmington	
	Santa Monica	
	Huntington Beach	
	Catalina Island	
	Hermosa Beach	

Source: California Department of Fish and Game (2008)

Numerous species of fish and invertebrates are caught and landed in commercial fisheries that take place off the southern coast of California. The most important species are Northern anchovy, Pacific mackerel, Pacific sardine, California spiny lobster, Red sea urchin, and Market squid.

Each species or species group is caught by using various methods and gear types. Traps are used for spiny lobster and some demersal fish species; sardines are usually caught in surrounding lampara or purse nets; tuna are caught on surface troll lines or longlines; rockfishes are generally captured by using trawls, set longlines, or trolling rigs; and squid are caught by encircling schools with a round-haul net, such as the purse seine or lampara net.

Commercial fisheries statewide having the greatest landing weights in 2007 were Pacific sardine (80 thousand tons), California market squid (49 thousand tons), Northern anchovy (10 thousand tons), sea urchins (five thousand tons), Pacific mackerel (five thousand tons) and Dungeness crab

(five thousand tons) (California Department of Fish and Game 2008). The species that accounted for the greatest dollar value were market squid (\$29 million), Dungeness crab (\$27 million), Pacific sardine (\$8 million) and chinook salmon (\$8 million) (California Department of Fish and Game 2008).

California landings are available by statistical area and port (California Department of Fish and Game 2008). There are three statistical areas that fall within the Southern Study Area, Santa Barbara, Los Angeles and San Diego. In 2007, 110 thousand tons of commercial fish were landed in these three statistical areas. On the basis of the percentage of total landings, these areas collectively accounted for 64 percent of the statewide total. The Los Angeles statistical area reported the largest total landings of 63 thousand tons, while the Santa Barbara and San Diego statistical areas reported landings of 45 thousand tons and 881 tons, respectively. The Los Angeles statistical area accounted for 57 percent of the landings that fell within the Southern Study Area, with Santa Barbara and San Diego area accounting for 41 and 1 percent, respectively.

In 2007, the total value of commercial fish landings that fell within the Southern Study Area was \$61 million, 51 percent of the statewide total (California Department of Fish and Game 2008). The value of landings was \$34 million for Santa Barbara, \$21 million for Los Angeles, and \$6 million for San Diego. As a percentage of the value of landings that occurred within the Southern Study Area, the Santa Barbara statistical area accounted for 56 percent, while the Los Angeles and San Diego statistical areas accounted for 34 and 10 percent, respectively.

At the species level, the top three species based on 2007 landings for the Santa Barbara area were Market squid (35 thousand tons), Red sea urchin (four thousand tons), and Pacific sardine (three thousand tons) (California Department of Fish and Game 2008). The top three species based on landings for the Los Angeles area were Pacific sardine (42 thousand tons), Market squid (13 thousand tons), and Pacific mackerel (five thousand tons). The profile of landings for San Diego differs from that associated with the other two statistical areas because the numbers of species landed, as well as, the size of landings were smaller. The two species with larger landings were red sea urchin (284 tons) and swordfish (178 tons).

The species with the highest value for the Santa Barbara area in 2007 were Market squid (\$21 million), Red sea urchin (\$4 million), and California spiny lobster (\$2 million) California Department of Fish and Game 2008). Market squid (\$8 million) was the species with the highest value of landings for the Los Angeles area, followed by Pacific sardine (\$5 million) and California spiny lobster (\$2 million). Species with greater value for the San Diego area were California spiny lobster (\$2 million), swordfish (\$1 million) and Red sea urchin (\$394 thousand).

Recently, profiles were developed for 120 fishing communities in California, Oregon and Washington using basic social and economic characteristics (Norman et al. 2006). The community selection process assessed involvement in commercial fisheries using quantitative data from the year 2000. Quantitative indicators looked at communities with commercial fisheries landings (weight and value of landings, number of unique vessels delivering fish to a community) and communities that served as homes to documented participants in the fisheries

(State and Federal permit holders and vessel owners). Indicators were assessed in two ways, as a ratio to the community's population and as a ratio of involvement within a particular fishery. The ranked lists generated by these two processes were combined and communities with scores one standard deviation above the mean were selected for profiling. Of the communities profiled, 50 were located in California.

More recently, data envelopment analysis (DEA) was applied to North Pacific and West Coast fisheries to determine the intensity of involvement of West Coast communities in commercial fisheries (Sepez et al. 2007). Communities assigned the highest possible score in one or more of the ranked lists by the DEA model for commercial fisheries dependence or engagement for the State of California were Bodega Bay, Crescent City, Field Landing, Fort Bragg, Moss Landing, San Diego, San Pedro, Santa Barbara, Tarzana, and Terminal Island. Out of this group of communities five are located within the Southern Study Area: San Diego, San Pedro, Santa Barbara, Tarzana, and Terminal Island.

13.9.2 Recreational Fisheries

Sport fishing is an important recreational activity throughout the West Coast of the United States. Information on recreational fish and shellfish landings in the region is available from the Pacific States Marine Fisheries Commission (2008). In 2007, about eight million fish were caught by recreational anglers in this region (Pacific States Marine Fisheries Commission 2008). California anglers accounted for the majority of these catches, about seven million fish. Catches made within the Southern Study Area totaled over four million fish during the same time period. Correspondingly, over four million trips were taken by California anglers, while the number of trips associated with the Southern Study Area totaled close to three million.

More than 190 fish and shellfish species have appeared in the recreational catch for California. However, only a few of the species made up most of the catch (Pacific States Marine Fisheries Commission 2008). About 150 species were caught within the Southern Study Area. The species with the highest catches in California were Pacific mackerel (1.3 million fish), followed by the catch of Jacksmelt (346 thousand fish). Pacific mackerel catches also dominated the catches taken within the Southern Study Area (more than one million fish). The next most prevalent species in catches taken within the Study Area was White croaker (297 thousand fish).

National Marine Fisheries Service collected and quantified marine recreational fishing expenditures and the economic impacts generated from angler expenditures for 2006 (Gentner and Steinback 2008). Data were collected from anglers fishing in all of the coastal states. Across all of the Pacific coastal states, anglers fishing in California exhibited the highest total expenditures (i.e., the sum of trip, fishing equipment, and durable good purchases). Anglers fishing in California spent an estimated \$3.0 billion on marine recreational fishing in 2006. In addition, the highest sales, value-added, income, and employment impacts were generated by angler expenditures in California. The \$3.0 billion spent on retail good and services by anglers in California in 2006 generated \$3.7 billion in total sales within the state, \$1.9 billion in value-added, \$1.3 billion in income, and supported 23,454 jobs.

13.10 LIST OF LITERATURE CITED—SOCIOECONOMIC RESOURCES

- American Association of Port Authorities. 2008. Port Industry Statistics. September 24, 2008. <http://www.aapa-ports.org/Industry/content.cfm?ItemNumber=900&&navItemNumber=551>.
- California Department of Fish and Game. 2008. Final 2007 California commercial landings. <http://www.dfg.ca.gov/marine/landings07.asp>.
- Dean Runyan Associates. 2008. California Travel Impacts by County. October 8, 2008. <http://www.deanrunyan.com/CATravelImpacts/CATravelImpacts.html>.
- Gentner, B. and S. Steinback. 2008. The Economic Contribution of Marine Angler Expenditures in the United States, 2006. Northeast Fisheries Science Center, National Marine Fisheries Service. Woods Hole, MA.
- National Ocean Economics Program. 2008. April 27, 2009. <http://www.oceaneconomics.org/>.
- Norman, K., J. Sepez, H. Lazrus, N. Milne, C. Package, S. Russell, K. Grant, R. Petersen, J. Primo, M. Styles, B. Tilt and I. Vaccaro. 2006. Community Profiles for West Coast and North Pacific Fisheries: Washington, Oregon, California, and Other U.S. States. <http://www.nwfsc.noaa.gov/research/divisions/sd/communityprofiles/>.
- Norman, K., J. Sepez, H. Lazrus, N. Milne, C. Package, S. Russell, K. Grant, R. Petersen, J. Primo, M. Styles, B. Tilt, and I. Vaccaro. 2008. Community Profiles for West Coast and North Pacific Fisheries: Washington, Oregon, California, and Other U.S. States. December 27, 2008. <http://www.nwfsc.noaa.gov/research/divisions/sd/communityprofiles/>.
- Office of Coast Survey, U.S. Dept. of Commerce, National Oceanic and Atmospheric Administration. 2008. NOAA ENC® Direct to GIS. May 5, 2009. http://www.nauticalcharts.noaa.gov/csdl/ctp/encdirect_new.htm.
- Pacific States Marine Fisheries Commission. 2008. Marine Recreational Fisheries Statistical Survey (MRFSS) Pacific Coast. December 27, 2008. <http://www.recfin.org/data.htm>.
- Public Policy Institute of California. 2003. It's a beach state...of mind: Despite tumultuous times, California's Golden Coast still captures hearts. April 1, 2009. <http://www.ppic.org/main/pressreleaseindex.asp>.
- Sepez, J., K. Norman and R. Felthoven. 2007. A quantitative model for ranking and selecting communities most involved in commercial fisheries. NAPA Bulletin 28(1):43-56.
- UCSB Economic Forecast Project. 2010. Regional Economic Outlooks. January 12, 2010. <http://www.ucsb-efp.com/About/>.
- U.S. Dept. of Commerce, National Marine Fisheries Service. 2008. Total Commercial Fishery Landings at Major U.S. Ports Summarized by Year and Ranked by Dollar Value. May 5, 2009. http://www.st.nmfs.noaa.gov/st1/commercial/landings/lport_year.html.

- U.S. Dept. of Commerce, U.S. Bureau of the Census. 2008a. Population Estimates. June 1, 2009. <http://www.census.gov/popest/overview.html>.
- U.S. Dept. of Commerce, U.S. Bureau of the Census. 2008b. Small Area Income and Poverty Estimates Program. April 30, 2009. <http://www.census.gov/did/www/saipe/about/index.html>.
- U.S. Dept. of Defense, U.S. Army Corps of Engineers, Navigation Data Center. 2008. Waterborne Commerce Statistics Center. April 30, 2009. [http://www.iwr.usace.army.mil/ndc/wcsc/wcsc.htm#2005%20Waterborne%20Commerce%20of%20the%20United%20States%20\(WCUS\)](http://www.iwr.usace.army.mil/ndc/wcsc/wcsc.htm#2005%20Waterborne%20Commerce%20of%20the%20United%20States%20(WCUS)).
- U.S. Dept. of Labor, Bureau of Labor Statistics. 2008. Databases, Tables & Calculators by Subject. January 8, 2009. <http://www.bls.gov/data/>.
- U.S. Dept. of the Interior, Minerals Management Service (MMS). 2001. Delineation drilling activities in federal waters offshore Santa Barbara County, California draft environmental impact statement. U.S. Dept. of the Interior, Minerals Management Service, Pacific OCS Region, Camarillo, CA. OCS EIS/EA MMS 2001-046.
- U.S. Dept. of the Interior, Minerals Management Service (MMS). 2007. Programmatic environmental impact statement for alternative energy development and production and alternate use of facilities on the Outer Continental Shelf. U.S. Dept. of the Interior, Minerals Management Service. Washington, DC. Ocs Study 2007-046.
- U.S. Dept. of the Navy. 2002. Final Environmental Impact Statement/Overseas Environmental Impact Statement Point Mugu Sea Range. Naval Air System Command, Naval Air Warfare Center Weapons Division. Point Mugu, CA.
- U.S. Maritime Administration. 2008. Library. April 30, 2009. http://www.maradot.gov/library_landing_page/Library_landing_page.htm.

14. SUMMARY OF NATURAL RESOURCES

14.1 PHYSICAL OCEANOGRAPHY

The Southern Study Area contains both the southern end of the large West Coast upwelling region that ends at Point Conception, and the relatively sheltered Southern California Bight. The ocean currents that dominate the circulation of the Southern California Current System (SCCS) and Southern California Bight (SCB) are the California Current, the Inshore Current and the California Undercurrent. Views of the seasonal transitions are changing with higher resolution sampling that indicates that the California Current may “regenerate” each spring, rather than simply moving between the offshore and onshore. Also, the concept of a large scale alongshore pressure gradient (Vancouver to Baja) that drives the dynamics in the CCS is an important advancement in understanding forcing in the SCCS and SCB.

Ocean temperature and salinity in the eastern Pacific are determined by three source water masses and air-sea energy exchange. North Pacific Subarctic Water, North Pacific Central Water and North Pacific Equatorial water are all present in the SCB. Subtidal temperature changes are correlated with the large-scale alongshore pressure gradient while upper ocean California Cooperative Oceanic Fisheries Investigations (CalCOFI) temperature trends are correlated with Pacific Decadal Oscillation (PDO). Salinity, though not correlated with the PDO, is correlated with the North Pacific Gyre Oscillation (NPGO). The latter suggests that sea surface temperature may be locally forced (wind, heat flux), while salinity is forced more remotely.

Upwelling favorable winds have increased, particularly during the warm season (April – September). The cool season winds are variable due to low pressure systems moving through the area. As these low pressure systems pass by, strong southeasterly winds precede the low, followed then by northwesterly winds. Though the upwelling favorable winds have increased, so have surface temperatures, leading to increased stratification, which inhibits upwelling. Higher upwelling indices are seen further north than the SCB in the CalCOFI data, but nutrients and zooplankton concentration are decreasing in the SCB, which suggests less upwelling than in previous decades.

14.2 GEOLOGICAL OCEANOGRAPHY

The physiography of the Southern Study Area is strongly controlled by tectonics, with the area north of Point Conception displaying a contiguous continental shelf, slope and abyssal plain; and with the southern area, from Point Conception to the Mexican border, displaying a fragmented continental shelf that consists of ridges and basins, largely related to the development of the San Andreas Fault System. Sediment supply to the deep basins is dominated by decadal and century-scale storm influx from fluvial sources, except in deep basins distal to sediment sources, where laminated sediment may reflect changes in primary productivity of the ocean water. Geologic hazards are dominated by earthquake shaking, fault rupture and deformation, mass-wasting events, and tsunami events.

Twenty-five percent of the sedimentary organic matter comes from river input; the rest is from primary production in the marine environment. River influx is highest in winter; biogenic primary production is seasonal and increases with spring-summer upwelling. The south-flowing California Current has diverse regional characteristics and intricate eddy motions; it has a major impact on biogeochemical distributions and near-shore waves and currents. Larger scale eddies occur near topographic features and transport materials away from the shelf; wind-driven summer upwelling is typically located south of headlands. Semi-permanent cyclonic gyres and associated spinoff eddies have been documented to control surface suspended sediment throughout the California Borderland, and are likely to control resulting sedimentation patterns of terrigenous silt and clay and associated organic matter. The distribution and fate of chemical constituents in continental shelf sediments include mineralization and dissolution of particulate organic matter. The passage of gravity waves and bottom currents over irregular surfaces of the continental shelf can enhance organic mineral crystallization in sandy shelf substrates.

Sediments transported by waves and littoral cell currents are redirected basinward by submarine canyons that may be located relatively nearshore, or at the seaward shelf margin. The intracanyon transport mechanisms are dominantly gravity-driven, and include mass wasting, turbidity currents, and transport as nephloid layers. Mass failure is often stimulated by an earthquake or storm event. The submarine canyons are unusual because they are headed close enough to shore to funnel sediments during both high stands of sea level as well as low stands.

14.3 CHEMICAL OCEANOGRAPHY AND GEOCHEMISTRY

The chemical oceanography of the Southern Study Area is strongly influenced by the California Current regime in the surface waters, and a broad suboxic zone that impinges on the continental slope at depth. Seasonal and spatially-variable upwelling strongly impacts the distribution of nutrients and primary productivity. These influences are overprinted with terrestrial inputs of chemicals originating from sources such as wastewater discharge, storm drainages and harbors, as well as anthropogenic legacy chemicals resuspended from the sediments. Hydrocarbon seeps are also prolific in the study area.

The California Current System is characterized by upwelling. The biologic process of primary production is often prolific in the upwelling regime of the California Current System. An understanding of this process influences the ability to predict the contribution of phytoplankton to carbon cycling, the development and persistence of harmful algal blooms, and the ability to use remote sensing to identify specific phytoplankton taxa which is important for biogeochemistry. Periodically, upwelling can be hindered by El Niño/La Niña events. Changes in ocean circulation result in changes in regional surface water temperature and the weak or no upwelling conditions strongly impact primary production.

Chemicals found in this region may come from land, sediment, other water masses, or may be produced in situ in these productive waters. Chemicals may further originate from natural or anthropogenic sources, including both point and nonpoint sources. The fates of chemicals released to these waters depend on the point of input (atmospheric, marine, or terrestrial) and the physical state (dissolved vs. particulate), and include transport to the North Pacific, recycling in the euphotic zone, deposition in any of numerous sedimentary environments, loss of volatile

components to the atmosphere, bioaccumulation, as well as in-situ chemical and biological transformation in the water column and sediments.

Seep research has been able to address important questions related to the role of the environment, geology and anthropogenic influences using new technologies. These techniques aim to quantify emissions on a range of temporal and spatial scales using multibeam sonar quantification of seep emissions, remote sensing of methane emissions, atmospheric sampling, video bubble measurement, turbine-tents, and three-dimensional seismic geologic modeling. Data from these techniques now allows important questions to be addressed; however, to date, insufficient data has been collected to answer these questions.

14.4 PHYTOPLANKTON, ZOOPLANKTON AND PELAGIC INVERTEBRATES

Planktonic organisms are integral parts of the marine food web. Phytoplankton forms the base of this food web by assimilating nutrients from oceanic currents and coastal inputs. Phytoplankton production is influenced by a number of factors including currents, upwelling, water temperature, nutrients, and light. In the Southern Study Area upwelling brings nutrients to the area which sparks increased growth and production. Much of this productivity is concentrated in the top several meters of water where light and nutrients are abundant.

Zooplankton growth and production are a result of the quantity and quality of available food (i.e. phytoplankton biomass). Because of the time it takes to assimilate nutrition into biomass, zooplankton and phytoplankton growth are hardly ever correlated in time. Rather, peaks of zooplankton will appear after peaks in phytoplankton. Zooplankton production is an important part of the marine food web, as it is the major connection between the lower food web and larger species, including fishes.

Pelagic invertebrates are an important component of the marine food web. Several species of squid are common in Southern California waters and the squid market is an important fishery. Gelatinous zooplankton can make up a large portion of the biomass and are sometimes considered their own branch of the food web, as they do not have as many predators as smaller crustacean zooplankton.

14.5 MACROPHYTES

Macrophytes encompass many different types of conspicuous aquatic plants. The physical characteristics of the Southern California Bight, its location between several currents, and its latitude result in a diverse and unique macrophyte community containing species of both northern and southern affinities. Kelp forests, dominated by giant kelp (*Macrocystis pyrifera*), are an important ecosystem in the Southern Study Area. These macrophytes support a wide variety of species interlinked in a complex food web. The rocky intertidal also supports a wide variety of macrophytes which, like kelp, are highly influenced by physical coastal processes and events, such as storms. Salt marsh grasses and other seagrasses characterize lagoons, embayments, and estuaries, which are important ecosystems, though relatively few remain in the Southern Study Area due to extensive coastline modification.

14.6 BENTHOS

Marine habitats are characterized by composition of the substrate as well as by ecological community features and species assemblage. Benthic organisms, which include both primary and secondary producers, are integral to ecological processes including the cycling of carbon, oxygen, and nutrients. Shallow subtidal habitats (<30 m) include kelp forests, unconsolidated sediments, and embayments. Erect frondose algae found in kelp forests support a diverse community of grazer, including echinoderms (urchins and sea stars), gastropods, and crustaceans (isopods, amphipods, shrimps, hermit crabs, and spider crabs), which are preyed upon by carnivorous invertebrates such as gastropods, crustaceans, sea stars, and octopi. In unconsolidated sediments (sand and mud sediments), “beds” of organisms tend to occur where one species (i.e. sand dollars or tube-dwelling polychaetes) typically dominates and stabilizes the sandy sediments and provides structure for other species. Embayments may host a wide variety of habitats including sandy shore, rocky shore, artificial shore, mud flats, salt marshes, seagrass beds, subtidal soft and rocky sediments. These habitats typically support diverse communities of plant life and invertebrates which provide important ecological services to primary predators and early life stages of fish species. The majority of the deep sea floor (>30 m) consists of vast expanses of soft sediments and is sparsely populated with epifauna in the Southern Study Area. Deposit, surface detrital, and scavenger feeding are typically the dominant foraging modes of most deep sea invertebrate benthos.

14.7 FISHES

The fish of the Southern Study Area are numerous and diverse. Assemblages of coastal and offshore habitats vary somewhat, but also have species that overlap. Species found in the oceanic epipelagic zone of the Southern Study Area are typically distributed worldwide in the temperate and tropical oceans. The assemblage is composed of small suspension feeders (e.g., anchovies and sardines) as well as larger predators (e.g., tunas). Many of these species are commercially harvested. The bay and estuarine fish assemblages consist of small to medium herbivores, detritivores, planktivores (i.e., topmelt), and carnivores (i.e., gobies). The rocky intertidal assemblage consists of pricklebacks, reef perch, scuplins, clingfish, kelpfish, and rockfish. Taxa contributing the greatest biomass, numerical abundance, or species richness to the rock-reef and kelp-forest community are Acanthopterygians (spiny-finned fish). The inner shelf assemblage includes anchovies, bass, rockfish, lizardfish, and scorpionfish. Federally-listed endangered and threatened fish species in the Southern Study Area include the green sturgeon (*Acipenser medirostris*), the tidewater goby (*Eucyclogobius newberryi*), and the Southern California evolutionarily significant unit (ESU) of West Coast steelhead (*Oncorhynchus mykiss*).

14.8 SEA TURTLES

Sea turtles inhabit tropical and subtropical seas and are relatively uncommon in northeastern Pacific waters north of Mexico. Historically, four species of sea turtles have been recorded in the northeastern Pacific: the green sea turtle (*Chelonia mydas*), the leatherback sea turtle (*Dermochelys coriacea*), the loggerhead sea turtle (*Caretta caretta*), and the Pacific (or olive) ridley sea turtle (*Lepidochelys olivacea*). While no species of sea turtles were historically found in the Southern Study Area, recent reports suggest that green turtles can be found living year

round near the thermal effluents of power plants near San Diego and Los Angeles. Sea turtle populations, all of which have been listed as threatened or endangered, have been greatly reduced by overharvesting, fisheries by-catch, disease, pollution, and coastal development of nesting beaches. Although there are no specific documented foraging events within the Southern California Bight between sea turtles and individual prey items, San Diego Bay is noted as an important foraging location for green turtles.

14.9 BIRDS

The Southern Study Area is utilized by hundreds of bird species that take advantage of the coastal and aquatic habitats and resources. The Southern California Bight offers a wide range of habitats for coastal bird species, which are utilized by both resident and migratory species. The mainland habitats, including beaches, estuaries, and marshlands, have been largely modified or degraded by human development and use. The Channel Islands offer a large amount of relatively undisturbed habitat that many bird species use for breeding grounds. Many seabirds nest on the cliffs of the Channel Islands and forage off the coast. A few others, including the endangered California population of the brown pelican, breed exclusively in the Southern Study Area. Birds found in this region fall into several categories, including marshbirds (herons, rails, cranes, ibises), waterbirds (ducks, geese, coots, grebes), shorebirds, and seabirds (birds found on or near coastal or offshore habitats).

14.10 MARINE MAMMALS

In the Southern Study Area, there are eight species of baleen whales (Suborder Mysticeti); all but gray whales, minke whales and Bryde's whales are federally listed as endangered species. Twenty species of toothed whales and dolphins (Suborder Odontoceti) inhabit the Southern Study Area, only one of which is federally listed as endangered (sperm whales). This region also includes six pinnipeds and also sea otters, three of which are threatened species (northern sea lions, Guadalupe fur seal and sea otter). Marine mammal populations continue to change rapidly off California, some as a result of protections from high levels of human exploitation that occurred in the past, and others in response to apparent environmental changes. In recent years several populations of marine mammals off California have been increasing, including fin and humpback whales, short-beaked common dolphins, and many pinniped species. Blue whales have shown a recent decrease in occurrence off California, apparently as a result in a shift in the proportional use of different feeding areas. There have also been some indications of a possible decline in beaked whale species. Human activities which cause impacts on California marine mammals include incidental mortality in fisheries, ship strikes, and the generation of underwater sound.

14.11 ECOSYSTEM INTERRELATIONSHIPS

The Southern Study Area is in an eastern boundary current system which is characterized by seasonal upwelling and high productivity. This productivity is connected to a wide variety of habitats and organisms found within the Southern California Bight. While most of the productivity remains in the Bight and immediately adjacent areas, some of this production can be transported to other areas via the California Current System.

The Southern California Bight occurs at a transition zone between the Oregonian and Californian biogeographical provinces. The demarcation between these is never exact and can move in and out of the Bight on seasonal, yearly, and decadal time scales. Organisms found in the Oregonian province generally prefer colder conditions than those found in the Californian; however, near the transition zones organisms have adapted to tolerate some variation in environmental conditions. This creates a unique community of organisms and habitats in the Southern California Bight, with high species diversity.

14.12 AREAS OF SPECIAL CONCERN

At present, nearly 50 Marine Protected Areas have been identified for the coastal Pacific region of the United States. The Channel Islands National Marine Sanctuary and National Park is located entirely within the Southern Study Area. Additionally, four of the 28 National Wildlife Refuges, one of the six National Estuarine Research Reserves, and one of the six National Estuary Program systems are located in the Southern Study Area. Other areas of concern include many archeological and historical sites, and weapons and chemical dumping grounds.

PART II—SOUTHERN STUDY AREA: IMPACTS

INTRODUCTION: A NOTE ABOUT IMPACTS

This literature synthesis describes the literature on potential impacts to various oceanographic resources from activities conducted as part of oil and gas energy development. While it attempts to focus on impacts that would be felt by resources within the study area, it is not a specific analysis or prediction of effects from a given project in a given location.

In the context of environmental analyses required by the National Environmental Policy Act (NEPA), impact levels are typically characterized along a continuum, from negligible to major, by their extent, duration, magnitude, and likelihood of occurrence. Throughout Part II, where these terms are used, they have the interpretations given below. Because physical resources and socioeconomic resources are so different, different interpretation of impact terms is appropriate; both definitions are presented below.

Impact Levels for Biological and Physical Resources

Negligible

- No measurable impacts.

Minor

- Most impacts to the affected resource could be avoided with proper mitigation.
- If impacts occur, the affected resource will recover completely without any mitigation once the impacting agent is eliminated.

Moderate

- Impacts to the affected resource are unavoidable.
- The viability of the affected resource is not threatened although some impacts may be irreversible, OR
- The affected resource would recover completely if proper mitigation is applied during the life of the project or proper remedial action is taken once the impacting agent is eliminated.

Major

- Impacts to the affected resource are unavoidable.
- The viability of the affected resource may be threatened, AND
- The affected resource would not fully recover even if proper mitigation is applied during the life of the project or remedial action is taken once the impacting agent is eliminated.

Impact Levels for Socioeconomic Issues

The following impact levels are generally used for the analysis of demography, employment, and regional income; land use and infrastructure; fisheries; tourism and recreation; sociocultural systems; and environmental justice.

Negligible:

- No measurable impacts.

Minor:

- Adverse impacts to the affected activity or community could be avoided with proper mitigation.
- Impacts would not disrupt the normal or routine functions of the affected activity or community.
- Once the impacting agent is eliminated, the affected activity or community will return to a condition with no measurable effects without any mitigation.

Moderate:

- Impacts to the affected activity or community are unavoidable.
- Proper mitigation would reduce impacts substantially during the life of the project.
- The affected activity or community would have to adjust somewhat to account for disruptions due to impacts of the project, OR
- Once the impacting agent is eliminated, the affected activity or community will return to a condition with no measurable effects if proper remedial action is taken.

Major:

- Impacts to the affected activity or community are unavoidable.
- Proper mitigation would reduce impacts somewhat during the life of the project.
- The affected activity or community would experience unavoidable disruptions to a degree beyond what is normally acceptable, AND
- Once the impacting agent is eliminated, the affected activity or community.
- May retain measurable effects indefinitely, even if remedial action is taken.

15. PHYSICAL OCEANOGRAPHY

15.1 EFFECTS OF CONTINUED INFRASTRUCTURE ON LOCAL OCEAN DYNAMICS

Effects to physical oceanography from infrastructure relate to how the water moves around these structures. As the water meets the structure, a small amount of the water's energy is lost through friction as the water flows around the object. Secondary effects come from the resulting changes in the water's velocity (speed and/or direction) and changes in turbulence. In this section, the change in circulation is discussed first, then a reference guide is supplied to other discussions of these secondary effects within the report. Computational Fluid Dynamics (CFD) modeling is continuing to advance, so modeling of fluid flow alterations could be modeled for any specific proposed structure to obtain details regarding the effects outlined below.

15.1.1 Effects on the Water's Movement

The mathematics of fluid flow around oil related infrastructure was first published by Lighthill (1979). Lighthill (1986) later updated his work, followed by Rainey (1989). These works investigated potential flow around a thin cylinder within a fluid, where one end is in the water, and one end is out of the water. The analysis is based on Morison's equation, an heuristic equation which balances the inertia force of the local flow with the drag force of the body in the fluid. Though these papers deal more with the issue of wave loading of offshore structures, they do provide some analysis of effects of the structure on the local circulation. Further work on wave loading has continued (Zhu and Moule 1994), but no significant advancements in understanding of these circulation alterations were found. Patel's (1989) book "Dynamics of Offshore Structures" is also a known reference on environmental loading of structures (winds, waves and currents). No references specific to wind flow around oil related infrastructure were found, though the changes to the flow would be similar. The one exception is that there is no equivalent to the sea floor bottom in the atmosphere.

Vorticity is generated at the solid boundaries of the object and shed into the object's wake (Lighthill 1986). Vortex shedding occurs to varying degrees in flow around blunt, solid objects. These effects only increase local mixing in the object's wake. These vortices and other forms of wake turbulence dissipate downstream of the object. This increase in mixing by single, well-designed platforms would not be expected to cause any long-term impact on physical oceanographic conditions in the Southern California Bight.

As waves interact with structures, the wave field is modified by reflection, refraction and energy absorption. Any alteration in the wave field as the waves interact with single, well-designed infrastructure (e.g. platforms) on the OCS, would cause negligible long-term effects. Variance in wave properties could cause alterations in the wave field. Wave interactions with single, well-designed structures are unlikely to cause significant alterations in the wave field more than several widths from the structure and thus would not be expected to cause any long-term impact on physical oceanographic conditions in the Southern California Bight. Modeling of alteration in local wave characteristics for coastal structures has been done by Joythi et al. (2001).

Though water column chemistry, such as temperature and salinity, can be changed by mixing, these parameters would not be changed very much by mixing due to oil and gas infrastructure. As water density is a nonlinear function of temperature and salinity, very small changes in local density could occur. These are likely to be too small to cause changes in the local dynamics.

Other activities that may impact physical oceanographic conditions are: sand and gravel mining, pipelines, submarine cables and other structures and foundations. These can have effects on currents flowing past them that can cause near- and far-field modification to sediment transport (discussed below) and alterations in the wave field. Proper design of any proposed projects would minimize alterations in the current flow, leading to negligible, highly localized impacts (USDOI, MMS 2009 and Michel et al. 2007).

15.1.2 Effects Due to Changing the Water's Movement

As the water flows around a structure, secondary effects can occur. Each of these effects is discussed in detail in other Southern Study Area impact chapters. Below is a short guide to finding further information in the report.

Sediment transport effects from presence of facilities – Alterations in the movement of water around structures can alter the amount and direction of sediment transport. Please see [Section 1.2](#) for further discussion.

Adverse Erosion and Scouring – Alterations in the movement of water can cause increases in erosion and scour rates. Please see [Section 1.3](#) for further discussion. Scour prediction modeling has been done by Jyothi et al. (2001). Local scour around bridge piers was examined by Zhiliang (2007) as flow around cylinders set on a rigid bottom. Results indicated that submerged cylinders with height less than one-and-one-half of the side width showed a 60 percent decrease in bed shear stress compared to an infinitely long cylinder.

Adverse Sediment Deposition – Alterations in the movement of water can cause sediments to accumulate in new areas. Please see [Section 1.4](#)

Adverse Changes in Local Turbidity – Alterations in the movement of water can cause increased in local turbidity. Please see relevant chapters on specific biota.

Adverse Changes to Beach Steepness – Single structures are unlikely to cause changes in beach steepness. Further discussion is available in the [Northern Study Area chapter on physical oceanographic](#) effects based on WEC devices, and can be found in Largier (2008).

Habitat Alteration – Alterations in each of the above factors can also be changes in local habitat. Please see relevant chapters on specific biota.

15.2 SUMMARY AND DATA GAPS

As water flows around a blunt object, friction reduces momentum, and a wake is created downstream of the object. The altered flow can cause changes in the local flow speeds (acceleration, deceleration) and direction, and increase mixing. These changes in flow can cause

secondary effects such as sediment scour, alteration on local turbidity and habitat alteration. Carefully designed structures are key to reducing these impacts. Development of efficient computation codes to allow engineers to test proposed structures with the local circulation would allow agencies to evaluate structures before they are constructed. The ability to extend this type of model would allow evaluation of the potential of invasives to utilize structures for migration ([see Northern Volume Section 11.3 for Island Biogeography](#) discussion). Engineering developments that allow oil and gas development with minimal infrastructure would also assist in reducing these types of effects.

15.3 LIST OF LITERATURE CITED—IMPACTS ON PHYSICAL OCEANOGRAPHY

- Joythi, K., J.S. Mani and M.R. Pranesh. 2001. Numerical modeling of flow around coastal structures and scour prediction. *Ocean Engineering* 29(4):417-444.
- Largier, John. 2008. The potential impact of WEC development on nearshore and shoreline environments through a reduction in nearshore wave energy. In: *Developing wave energy in Coastal California: Potential socioeconomic and environmental effects*. California Energy Commission, PIER Energy-Related Environmental Research Program and California Ocean Protection Council.
- Lighthill, J. 1979. Waves and hydrodynamic loading. In: *Proceedings of the 3rd International Conference on the Behavior of Off-shore Structures*, Vol. 1. BHRA Fluid Engineering, Cranfield, Bedford, England. Pp. 1-40.
- Lighthill, J. 1986. Fundamentals concerning wave loading on offshore structures. *Journal of Fluid Mechanics* 173(1):667-681.
- Michel, J., H. Dunagan, C. Boring, E. Healy, W. Evans, J.M. Dean, A. McGillis and J. Hain. 2007. Worldwide synthesis and analysis of existing information regarding environmental effects of alternative energy uses of the Outer Continental Shelf. U.S. Dept. of the Interior, Minerals Management Service, Herdon, VA. OCS Study 2007-038. 254 pp.
- Patel, M.H. 1989. *Dynamics of offshore structures*. Sevenoak (UK), Butterworth. 408 pp.
- Rainey, R.C.T. 1989. A new equation for calculating wave loads on offshore structures. *Journal of Fluid Mechanics* 204(1):295-324.
- U.S. Dept. of the Interior, Minerals Management Service (MMS). 2009. *Cape Wind Energy Project: Final environmental impact statement*. U.S. Dept. of the Interior, Minerals Mangement Service, Herdon, VA. OCS Publication No. 2008-040. 800 pp.
- Zhiliang, O. 2007. *Numerical simulation of flow around vertical cylinders*. Ph.D. Dissertation, University of Western Australia.
- Zhu, S. and G. Moule. 1994. Numerical calculations of forces induced by short-crested waves on a vertical cyinder of arbitrary cross section. *Ocean Engineering* 21(7):645-662.

16. GEOLOGICAL OCEANOGRAPHY

The interactions of oil and gas infrastructure and tectonic activity must be considered together in order to discuss impacts. The larger the human structure, the more force is necessary for construction, which relates to the force exerted on the local seabed and if pierced on the internal geologic structure. Young or active tectonic features, regardless of size, would be more vulnerable to external forces than older inactive features. Drilling operations set forth from human infrastructure, regardless of size of the structure, could encounter geologic features, such as gas reservoirs and cause a blowout, and create an impact. The larger the reservoir encountered, the larger the impact, again, unrelated to the size of the human infrastructure.

The offshore areas of the Southern Study Area have complex tectonic and sediment transport interactions, as described in [Chapter 2 \(Geology Resources\)](#); very few studies have been done on the effects of oil and gas exploration on the geology of the Southern Study Area, or other petroleum producing coastal margins of the world. While offshore oil and gas installations will have limited effect on the occurrence or magnitude of plate slippage or resulting tsunamis, the facilities could themselves be affected by tectonic activity, resulting in damage to facilities, spills, and the potential for equipment to be torn loose and washed ashore, causing nearshore habitat damage (Davis et al. 1982). For example, areas of the Southern Study Area that may be at risk include the region of the Goleta Slide ([Figure 16.1](#))

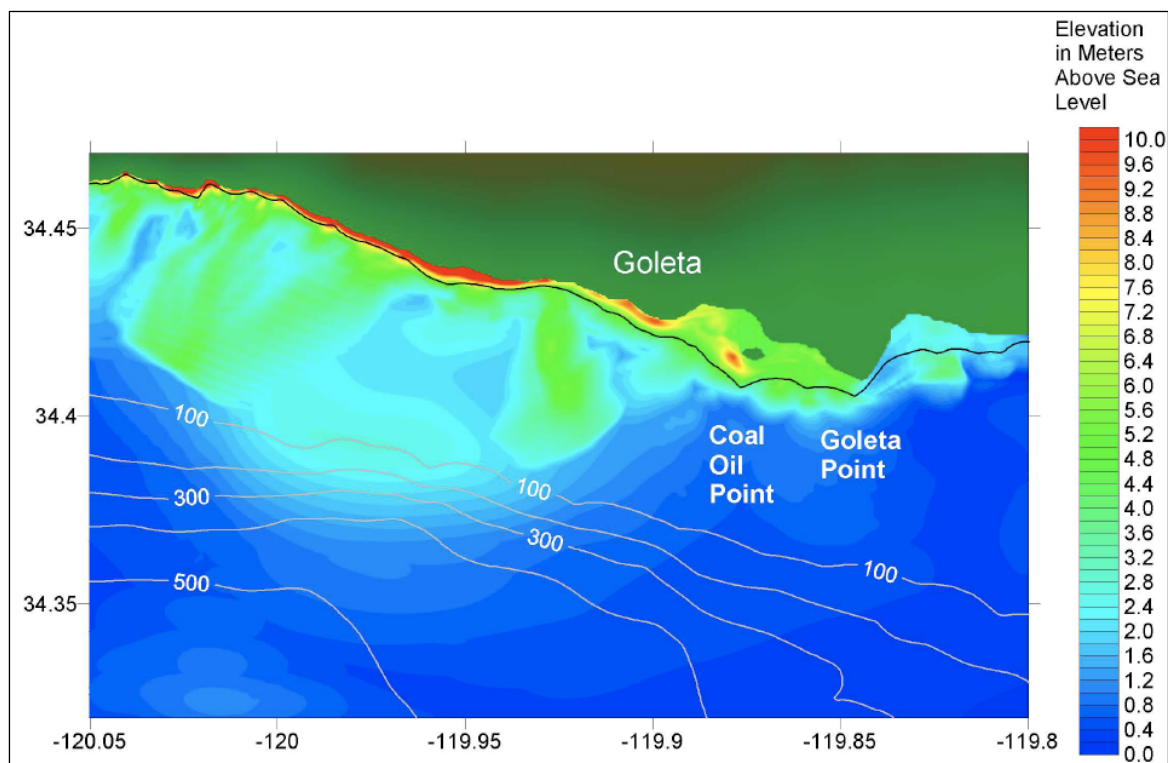

Figure 16.1. Maximum tsunami amplitudes from numerical simulation of the tsunami generated by the Western segment of the Goleta slide.

(Greene et al. 2006).

16.1 BEDFORM MIGRATION EFFECTS FROM SITING OF ENERGY FACILITIES

Dynamic bedforms, such as sediment waves and dunes, indicate strong bottom currents and constant sediment supply, unless the sediments are relict. The formation and migration of these bedforms could be altered or interrupted by energy facilities and their associated infrastructure. Many modern bedforms are concentrated in submarine canyons where debris flows and turbidity currents occur and where sediment supply at canyon heads is considerable.

Today, dammed rivers and coastal erosion contribute sediment that is sorted into progressively finer grain sizes; so that by the time coastal sediments reach submarine canyons, only sand and fine-grained sediments remain to create these bedforms (Paull et al. 2007; Normark et al. 2009). Dynamic bedforms can also occur on the continental shelf, especially in the shallow parts where severe storms result in strong bottom currents that transport sediment (Dartnell and Gardner 2009). On the Outer Continental Shelf sea floor, erosional environments exist where relict deposits and exposed bedrock indicate sediment-starved conditions. Conditions such as these can be found in the nearshore as well (e.g., Point Conception, Point Dume, Santa Monica Bay, Palos Verdes shelf, and Point Loma) and on the central and outer Southern California continental borderland ridges and narrow island shelves.

Several different geomorphic features form the dynamic bedforms found on the sea floor. These include rippled sand depressions, dunes, and sand waves. Often the rippled sand depressions consist of thin (30-40 cm) sand sheets with steep lee surfaces that migrate across a flat gravel lag or bedrock surface, which are common in the northern part of the Southern Study Area. These bedforms may also be found along the inner mainland shelf and the central and outer borderland ridges and island shelves. Interruption of sediment flows due to the presence of energy facilities, pipelines, and associated infrastructure have the ability to change the rate of formation of these bedforms, altering the underwater landscape gradually over time (Davis et al. 1982).

16.2 SEDIMENT TRANSPORT EFFECTS FROM THE PRESENCE OF FACILITIES

Sediment transport effects from offshore energy facilities include differential sediment accumulation due to the presence of structures on the sea floor. Changes in accumulation can sometimes affect the distribution or viability of natural biota. Strong bottom currents are capable not only of transporting sediment but of scouring and eroding sediment and other material around any impediment on a flat sea floor. Infrastructure installation on the sea floor can interrupt the laminar flow of sediments and disturb the sediment-supply equilibrium. Therefore, the areas of concern in the Southern Study Area are where bottom sediment transport is active. These areas occur in the central to southern part of the Santa Barbara Channel continental shelf, Point Dume shelf, outer Santa Monica Bay, Palos Verdes shelf, outer San Pedro shelf, and the narrow Oceanside-to-Point Loma shelf (Sommerfield et al. 2009; Warrick and Farnsworth 2009).

16.3 ADVERSE EROSION AND SCOURING

Scouring and erosion on the sea floor and within submarine canyons occur primarily by two processes: (1) strong bottom currents generated during storms; and (2) turbidity currents that

transport sediment downslope, generally in submarine canyons, forced by gravity. Storm-generated scouring and erosion are primarily restricted to the continental shelf and are particularly significant during times of El Niño-Southern Oscillation (ENSO) events, coincident with the influx of fluvial and eroded bluff sediment and generally at decadal recurrence intervals (Warrick and Farnsworth 2009). Sediment accumulation generally decreases in the offshore direction and is primarily transported parallel to the shore within small littoral cells (Alexander and Lee 2009). Fast moving turbidity currents, carrying fine-grained sediments, are generated along the distal edge of the continental shelf, eroding the slope (Sommerfield et al. 2009). Scouring is most prominent where impediments, such as rocks, wrecks, or infrastructures (e.g., pipelines, platforms), rise above a flat sea floor. Variable rock outcrops exist offshore of major coastal prominences. Where infrastructure is present, erosion and scouring patterns may be initiated or altered, resulting in changes in bathymetry, bottom cover, and biota. If occurring near the heads of gullies or canyons, erosion may affect the landward extension of these features and may have the potential to interrupt littoral drift (Davis et al. 1982).

16.4 ADVERSE SEDIMENT DEPOSITION

Turbidity currents are most common in submarine canyons, but can occur along the continental slope as well, especially in areas where substantial quantities of sediment are delivered to the marine environment, such as offshore of major river mouths. Seafloor-based infrastructure may cause accumulations of unstable sediments that could result in turbidity currents or has the potential to cause sediment to accumulate in biomes that are normally free of sediment cover. While it is possible that the presence of oil and gas facilities, pipelines and associated infrastructure could change the deposition patterns of turbidity currents and other sediment flows, there have been no recent studies to document this phenomenon in the Southern Study Area.

16.4.1 Generation of Mass Movements

Additional sediment load that is focused by, or that accumulates around, seafloor infrastructures could contribute to slope instability. Landslides and mass sediment transport are generally restricted to the submarine canyons and steep continental and island slopes. The largest landslide mapped in the area is the Goleta Slide in Santa Barbara Channel, a complex compound slide sufficiently large that any one of its three slide lobes could have produced a tsunami if failure occurred instantaneously ([Figure 16.2](#)). Additional mass movement features have been mapped along the northern flank of the Santa Barbara Basin, which indicates an area of instability (Greene et al. 2006). To the north, landslides along the western margin of the Santa Lucia Bank are present; however, these are not as large as the Goleta Slide and may not be a severe threat of tsunami generation. The next largest slide in the southern area is a rock avalanche deposit mapped at the base of the eastern San Pedro Basin flank, which also could have produced a tsunami if failure had been instantaneous. There are no studies that indicate whether the magnitude of sediment transport disruptions caused by oil and gas exploration could produce underwater landslides and changes in mass sediment transport in the Southern Study Area.

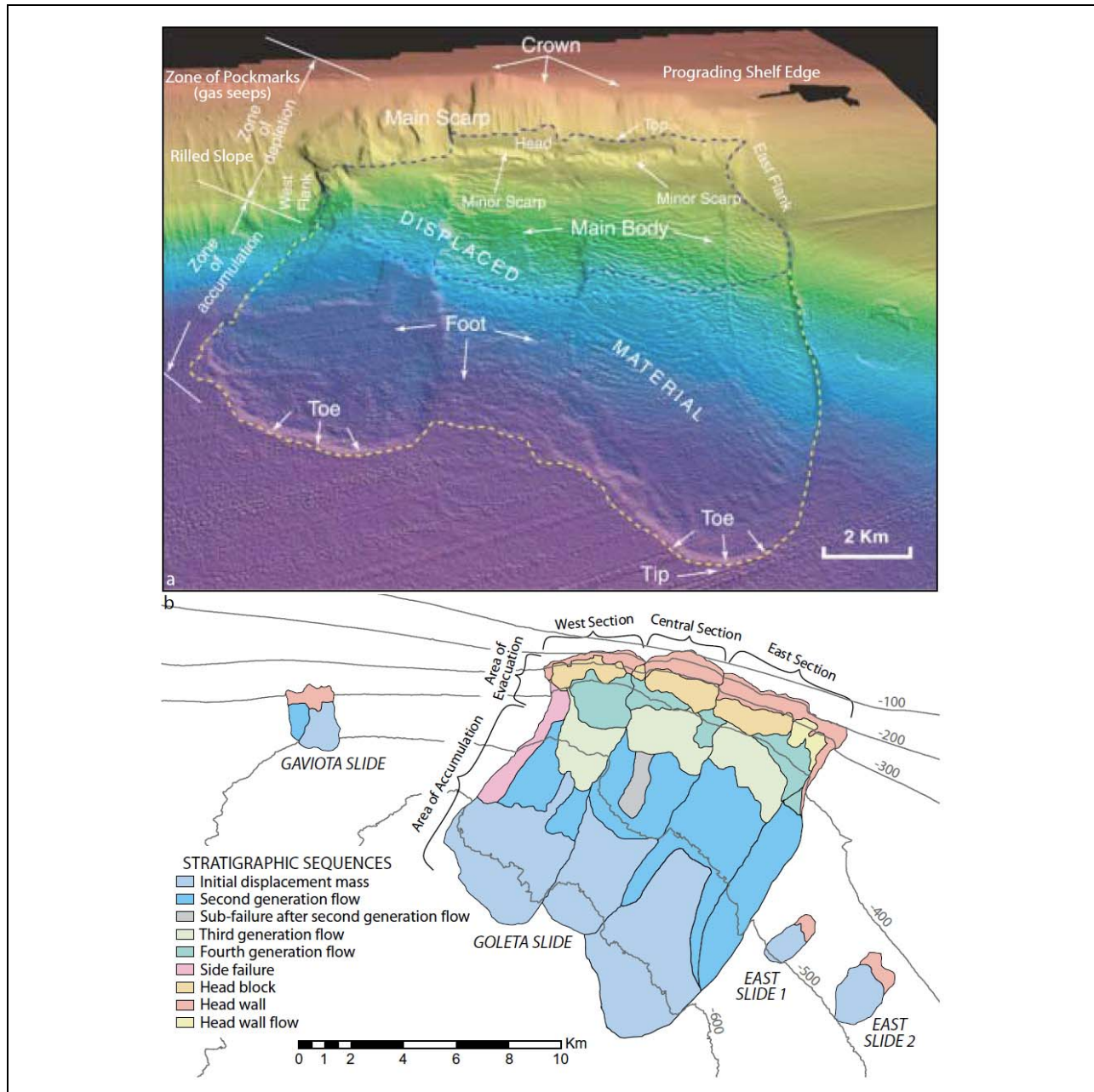

Figure 16.2. The Goleta slide complex: a) multibeam bathymetric image showing multiple lobes, mass failures, slump blocks and scarps of the Goleta slide; b) Sub components of the Goleta slide and other slides in the Santa Barbara Channel.

(Greene et al. 2006)

16.4.2 Seafloor Collapse

The potential exists in oil and gas fields for surface subsidence such as occurred in the Termian Island area of San Pedro-Long Beach area during the 1950s as well as the generation of hummocky or irregular topography that, in turn, affects deposition, erosion, or mass wasting. No seafloor collapses occurrences in the Southern Study Area or study of such is known to the

authors. Gas venting and oil seeps are still active in the Santa Barbara Channel area, although much of this activity has slowed as hydrocarbon extraction has nearly exhausted the petroleum reserves in the area and reduced formation pressures (Eichhubl et al. 2002). The weight of energy infrastructure could cause localized collapse of weakly supported sea floor in these areas, but such accounts are unknown to the authors. The impacts of such a seafloor collapse would include changes in benthic habitat, further changes in sediment transport pathways, and potential increases in mass failures resulting in underwater slides. A study of a small induced seismic event in the North Sea oil fields in 2001 demonstrates the impact that water injection in the course of petroleum exploration can have on geological features (Ottermoller et al. 2005). Greene et al. (2006) delineated the areas of the Santa Barbara Basin where similar seismic events could be triggered by injection of fluids into the sea floor ([Figure 16.3](#)).

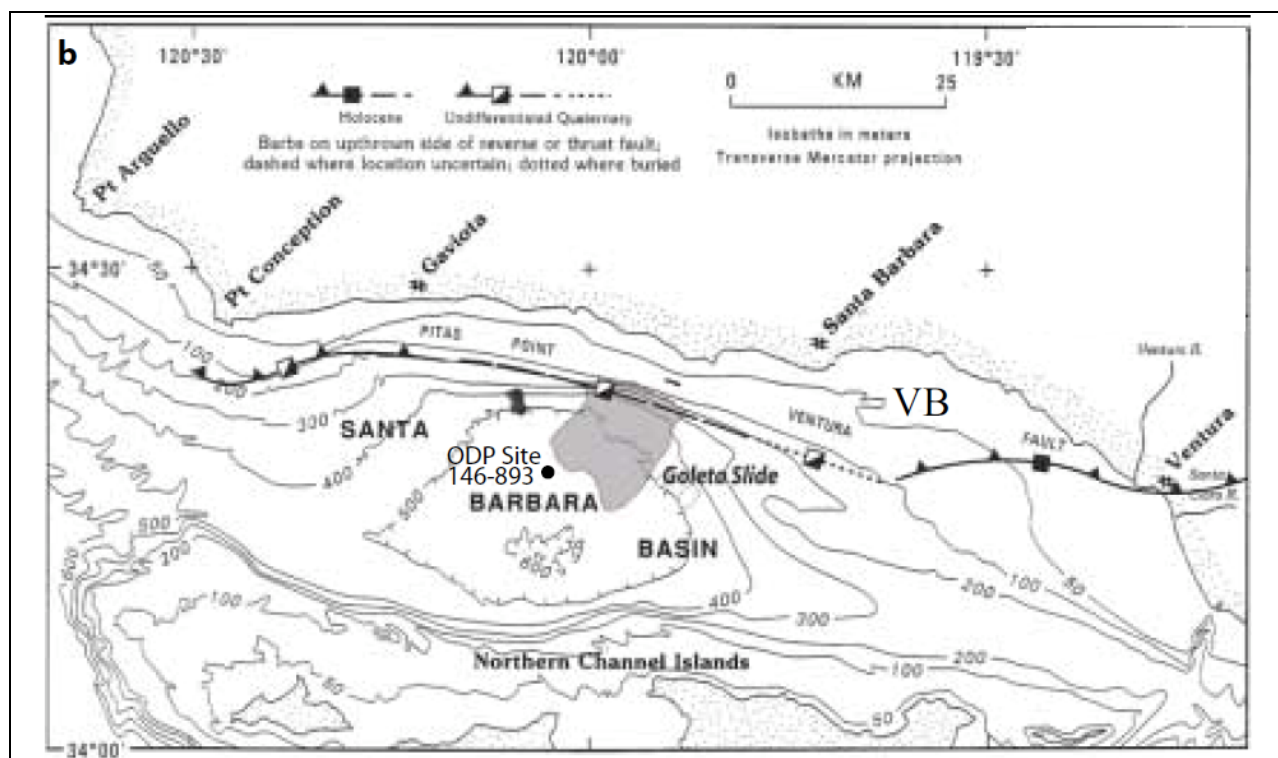

Figure 16.3. Location of major faults that direct fluid to the sea floor, that can rupture during earthquakes. (Greene et al. 2006)

16.5 SUMMARY AND DATA GAPS

Oil and gas facilities are expected to have little effect on most major geologic features of the continental shelf and slope in the Southern Study Area, as the structures are very small in comparison to geological features and will not produce forces large enough to disturb continental plates. However the oil and gas facilities may be affected by tectonic activity, resulting in damage to facilities, spills, and the potential for equipment to be torn loose and washed ashore, causing nearshore habitat damage.

Sediment transport could be affected by oil and gas facilities, resulting in changes to some bedforms and turbidity currents, which in turn could affect some geological processes including the movement of sediment in and out of submarine canyons, and shoreline forms subject to erosion. Storms also play a major role in forcing sediment mobilization and transport and the effect of storm stress on the seafloor in the vicinity of oil and gas seafloor infrastructure needs further study at potential sites.

There is a concern that if sufficient oil and gas reserves, and associated water and sediment, are removed, then slides and mass movements of sediment could occur. Since no research has been done to determine this cause and effect, monitoring infrastructure and potential slide areas is needed. In addition, sufficient removal of reserves could result in localized seafloor collapse, so monitoring is needed.

Additional data is needed in order to understand the sustainable limits of oil and gas removal in areas of natural seeps; in particular, to understand the levels at which removal will begin to mobilize underwater slides.

16.6 LIST OF LITERATURE CITED—GEOLOGY

- Alexander, C.R. and H.J. Lee. 2009. Sediment accumulation on the Southern California Bight continental margin during the twentieth century. In: Lee, H.J. and W.R. Normark. Earth sciences in the Urban Ocean: The Southern California Continental Borderland. Geological Society of America Special Paper 454. Pp. 69-87.
- Dartnell, P. and J.V. Gardner. 2009. Seafloor terrain analysis and geomorphology of the greater Los Angeles Margin and San Pedro Basin, Southern California. In: Lee, H.J. and W.R. Normark. Earth sciences in the Urban Ocean: The Southern California Continental Borderland. Geological Society of America Special Paper 454. Pp. 9-29.
- Davis, N., G.R. VanBlaricom and P.K. Drayton. 1982. Man-made structures on marine sediments: Effects on adjacent benthic communities. *Marine Biology* 70:295-303.
- Eichhubl, P., H.G. Greene and N. Maher. 2002. Physiography of an active transpressive margin basin: High-resolution bathymetry of the Santa Barbara Basin, Southern California Continental Borderland. *Marine Geology* 181:95-120.
- Greene, H.G., N. Maher, C.E. Paull, M.A. Fisher, P. Eichhubl, P. Watt and L. Murai. 2006. Submarine landslides of the Santa Barbara Basin: Potential tsunami generators. *Natural Hazards and Earth System Sciences* 6:63-88.
- Normark, W.R., D.J.W. Piper, B.W. Romans, J.A. Covault, P. Dartnell and R.W. Sliter. 2009. Earth sciences in the Urban Ocean: The Southern California Continental Borderland. In: Lee, H.J. and W. R. Normark. Geological Society of America Special Paper 454. Pp. 141-168.

- Ottmoller, L., H.H. Nielson, K. Atakan, J. Braunmiller and J. Havskov. 2005. The 7 May 2001 induced seismic event in the Ekofisk oil field, North Sea. *Journal of Geophysical Research* 110, B10301, doi:10.1029/2004JB003374.
- Paull, C.K., W.R. Normark, W. Ussler, III, D.W. Caress, R. Keaten, J. Barry, J. Xu, D. Smith, J.A. Covault and K.L. Maier. 2007. Large wave-shaped bedforms in the axial channel of Monterey submarine channel, Monterey Bay, California. *Eos Trans. AGU* 88(52):Abstract H54B-03.
- Sommerfield, C.K., H.J. Lee and W.R. Normark. 2009. Postglacial sedimentary record of the Southern California continental shelf and slope, Point Conception to Dana Point. In: Lee, H.J. and W.R. Normark. *Earth sciences in the Urban Ocean: The Southern California Continental Borderland*. Geological Society of America Special Paper 454. Pp. 89-115.
- Villaescusa-Celaya, J.A., E.A. Gutiérrez-Galindo and G. Flores-Muñoz. 2000. Heavy metals in the fine fraction of the coastal sediments from Baja California (México) and California (USA). *Environmental Pollution* 108: 453–462.
- Wall, C, T. Rockwell, K. Mueller, Y. Bock, S. Williams, J. Pfanner, J. Dolan and P. Fang. 1998. Escape tectonics in the Los Angeles metropolitan region and implications for seismic risk. *Nature* 394:356-360.
- Warrick, J.A. and K.L. Farnsworth. 2009. Sources of sediment to the coastal waters of the Southern California Bight. In: Lee, H.J. and W.R. Normark. *Earth sciences in the Urban Ocean: The Southern California Continental Borderland*. Geological Society of America Special Paper 454. Pp. 39-52.

17. CHEMICAL AND GEOCHEMICAL OCEANOGRAPHY

17.1 LEACHING OF CHEMICALS (PAINTS AND ANTIFOULING COATINGS)

The possibility of contaminant leaching from paints and antifouling coatings used in structures for wave energy development was raised in the proceedings of a workshop edited by Boehlert et al. (2008). Concerns centered primarily on dissolved metals such as copper in antifouling paints or zinc from sacrificial anodes. No data were presented, but the data gaps and uncertainties identified led to recommendations for baseline and monitoring studies of release rates and accumulation, at a minimum, of copper and butyltin in water, tissues, and sediment. It was also stressed that monitoring for effects needed to include not just mortality but also changes in species abundance and movement. Community level ecological concerns included questions about bioaccumulation and transfer of leached chemicals through trophic levels. Receptors of highest concern were pelagic fish, forage fish, and invertebrates. Medium-impact groups included benthic habitats, plankton, commercial fish, epibenthic macroinvertebrates, and benthic infauna. Low-impact receptors included pinnipeds and cetaceans. Finally, the development of less toxic and more specifically targeted antifouling chemicals was encouraged.

No references were found in the literature specifically dealing with leaching of paints or antifouling coatings from oil platforms or other structures associated with oil and gas exploration or production in the Southern California Bight (SCB). Venkatesan et al. (1998) examined butyltins in sediments from the deeper waters of the Santa Monica and San Pedro basins in water depths of 458 m on the shelf to 906 m in the central basins. Surficial and a few subsurface sections from selected cores were analyzed, and the dominant components found were generally dibutyl- and monobutyltins (DBT and MBT), respectively. These results suggested that microbial degradation of tributyltin (TBT, the most toxic of the butyltin species) to DBT and MBT during the long-range transport to deeper basins, as well as a lack of continuing inputs of TBT in the present time, explained the butyltin signatures found in the region. The levels of butyltins could not be traced to any specific source, and the concentrations were in the lower range (below detection level, less than 1 to 14 ng Sn/g) relative to nearshore sediments. However, the results demonstrate that the butyltins are indeed found even in the sediments of the central basins of the Southern California borderland, suggesting that deeper global oceanic regimes need to be further investigated for these compounds.

Volpe and Esser (2002) used a quadrupole inductively coupled plasma (ICP) mass spectrometer at sea to acquire continuous trace element data during a survey of San Diego Bay and the adjacent coastal environment. The data led to mapping the distribution of a suite of biologically active trace metals (manganese, nickel, zinc, copper, and cadmium) in San Diego Bay, and the bay signature was tracked into the nearby coastal ocean. The continuous data provided chemical gradients within the bay, with which the authors were able to estimate the contaminant metal flux that is discharged from the bay into the coastal ocean during tidal pumping.

In an effort to identify the source of the dissolved copper from antifouling paint on recreational vessels in harbors and marinas, Schiff et al. (2004) painted three different formulations on fiberglass substrates and submerged them in harbor waters. They used a recirculating dome

system to complete in situ measurements of copper in the water, and the calculated monthly average flux rates of dissolved copper ranged from 0.2 to 4.3 $\mu\text{g}/\text{cm}^2/\text{day}$, depending on the formulation. The effects of aggressive hull cleaning were also evaluated; however, it was estimated that roughly 95 percent of copper was emitted during passive leaching. In a subsequent study, Schiff et al. (2007) completed water column sampling in marinas of the San Diego region and concluded that although exceedance of State water quality objectives was widespread (86 percent of marina area), toxicity was much less prevalent (21 percent of the marina area).

The results from the above harbor studies at marinas with limited water circulation are not directly applicable to anticipated impacts from paint and antifouling coatings possibly used on offshore platforms. Because of the much more dynamic and energetic current/wave regimes in the offshore environment, dilution and advective removal of any dissolved components from leaching would be expected. This is borne out by numerous papers published on the proliferation of marine organisms in and around offshore platforms in Southern California (Mearns and Moore, 1976; Wolfson et al. 1979; Reish 1980; Dailey et al. 1993; USDOJ, MMS 2001; Love and York 2006; Page et al. 2007). It is far more likely that localized toxicity might be expected from produced water discharges ([section 17.5.3](#)) than from the leaching of components from antifouling paint.

17.2 CHEMICALS MODULATED DURING DEVELOPMENT, OPERATION, AND REMOVAL OF STRUCTURES

Chemicals used during the development and operations of offshore drilling platforms are considered below in separate sections on drilling muds, workover and treatment fluids, and produced waters. Additional details on discharges from active offshore production platforms worldwide are considered by Holdway (2002), and specifically for the SCB during 1996 and 2000 by Steinberger et al. (2005), who concluded that based on the total discharges and constituent concentrations, oil platform discharges were minor compared to effluents from large and small POTWs in terms of both volume and constituent mass emissions.

Prasthofer (1997) highlighted the approaches necessary to ensure containment and decontamination of oil, chemicals, and other potentially hazardous materials from platform topside facilities (vessels, tanks, pumps, and piping) during decommissioning and removal activities. The primary objectives of the removal and decontamination procedures described were to eliminate explosion and fire risks associated with hydrocarbon residues and to remove the potential for release of any hydrocarbons or pollutants into the marine environment. Vessels or equipment of particular concern included transformers, coolers, scrubbers, separators, heat exchangers, bulk storage tanks, biocide containers, diesel tanks, paint containers, batteries, fire extinguishing equipment, pumps, engines, generators, oil sumps, and hydraulic systems. Corrosion inhibitors and other chemicals used during drilling (drilling muds and additives) are unlikely to remain in bulk on a platform at the time of decommissioning; however, if they are still present, such materials would be shipped back, preferably in the original containers, for reuse or disposal at appropriate reception facilities onshore. Decontamination procedures would already be established for platform maintenance work requiring cleaning and dismantling of the various operational systems, and they would be implemented before platform decommissioning.

In general, the procedures necessary to prepare a hydrocarbon system for "hot work" would satisfy the requirements of being substantially "hydrocarbon free" prior to disposal. Such procedures have been developed by each operator over a number of years and are in routine day-to-day use. Elements of standard industry procedures for flushing of tanks and pipework should be followed, including: (1) depressurizing, (2) draining, (3) venting, and (4) purging and flushing, as appropriate for the system under consideration (Prasthofer 1997).

There is very little additional published information on the chemicals that might be involved or released during decommissioning and removal of offshore platforms and installations. Schroeder and Love (2004) identified the need for additional scientific data on the possible biological effects of any residual contaminants, but no specific data or measurements of potential contaminants of concern were presented. Major issues they identified include the likelihood that contaminated sediments are resuspended in the water column during removal of structures embedded on the sea floor. Damage to soft sediment communities and resuspension of contaminated materials may occur from anchoring and associated activities and from dragging platform legs if the jacket is removed using progressive transport methods. If complete removal is selected as the decommissioning option, local benthic species composition will shift toward a soft sediment community (if the shell mound is removed) or to a community similar to one inhabiting areas with low-relief cobble (if the shell mound is left in place). Schroeder and Love (2004) also stated that an intact shell mound at the base of a platform would provide a natural "cap" to local contaminants that may have accumulated in the area from past drilling operations. If a platform's shell mound is removed, they surmised that these contaminants may be resuspended in the water column and could cause an undetermined amount of environmental damage. These predictions were in fact at least partially confirmed at the 4H shell mounds site in the Santa Barbara Channel during later studies discussed in greater detail below (Phillips et al. 2006).

In 1996, Chevron removed oil platforms Heidi, Hilda, Hazel, and Hope (the so-called 4H platforms) off the coast of Southern California near Summerland and Carpinteria, leaving behind massive mounds of mussel shells. The mounds, approximately 200 feet wide and 20 to 30 feet tall, had accumulated as a result of periodic scrapings of the initial platform legs (Camozzi 1997). The actual removal and disposal procedures are described by Culwell (1997) and in other articles from the proceedings of a public workshop on decommissioning and removal of oil and gas facilities in offshore California waters (Manago and Williamson 1997).

Only one study has been published on the potential chemical impacts from the residual materials left after platform decommissioning and removal in the SCB (Phillips et al. 2006). This study examined the remobilization, bioavailability, and potential toxicity of chemical contaminants at the 4H shell mounds site in the Santa Barbara Channel region. Evaluations used a weight-of-evidence approach based on results from bulk phase chemical analyses and laboratory toxicity tests of shell mound cores, in situ field bioassays using caged mussels, and surficial sediment chemistry. Shell mound cores contained elevated concentrations of metals associated with drilling wastes (e.g., barium, chromium, lead, and zinc), as well as alkylated benzenes and polycyclic aromatic hydrocarbons (PAH). The highest contaminant concentrations (and pockets of free oil) were associated with the middle "cuttings" stratum. Sediments composited from all

core strata caused significant acute toxicity and bioaccumulation of barium and PAHs in test organisms during laboratory exposures. In contrast, caged mussels placed at each of the shell mounds for a period of 57 to 58 days had a greater than 90 percent survival rate, and there were no significant differences in survival of mussels placed at the shell mounds and corresponding reference sites. In addition, while all mussel samples exhibited increases in shell length, whole animal weight, and tissue lipid content, growth metrics for the shell mound mussels were in some cases significantly higher than those for the reference sites. Concentrations of metals, PAHs, and polychlorinated biphenyls (PCBs) in tissues of the caged shell mound mussels were not significantly different from those at reference sites.

The presence of labile aromatic hydrocarbons in shell mound cores and the absence of significant contaminant accumulation in tissues of caged mussels indicated that chemical contaminants are not being remobilized from the 4H shell mounds. Surficial bottom sediments near the shell mounds contained elevated Ba concentrations that probably were associated with drilling wastes; however, concentrations did not exhibit clear spatial gradients with distance from the shell mounds. Despite a number of storm events during the mussel exposures, maximum currents (34 cm/s) were unlikely to erode materials from the shell mounds. Thus, the authors concluded that barium distributions in bottom sediments were due to episodic disturbances during platform removal or trawling rather than ongoing erosion and dispersion of shell mound solids by near-bottom currents. These results tend to confirm the hypotheses of Schroeder and Love (2004) discussed above and suggest that, in the absence of physical disturbances, contaminants are expected to remain sequestered in the shell mounds for at least the foreseeable future.

17.3 EFFECTS OF INCREASED VESSEL TRAFFIC

The negative effects of increased vessel traffic in the Southern California Bight include: a higher risk of discharges and spills, leaching of bottom paints ([discussed in section 17.1](#)), and increased atmospheric pollution from ship exhausts. Repeated routine discharges from commercial vessels related to the oil and gas industry are likely to cause more adverse effects than much rarer oil spill events. Though oil spills are more damaging when they occur, oil spills are less frequent than discharges. Bottom paints are used on all seagoing vessels, including commercial vessels. The effects of toxic chemicals leaching from the hulls of ships may pose a minor to moderate impact in enclosed areas. Ship exhaust fumes from engines powered by fossil fuels will release a variety of chemicals into the atmosphere. Exhaust fumes from fossil fuel engines significantly reduce air quality.

Discharges from commercial vessels generally fall under the categories of bilge (water in the boat), fuel, lubricating and hydraulic fluids, cleaning agents, paint, and human waste. Bilge water has potential to be the primary pollutant from increased boat traffic. Bilge contains not just water but also chemicals from minor spills or leaks originating from engines or other machinery and general operations. This can include anything liquid from the discharge categories. The routine discharge from a single vessel will cause negligible impacts. However, the cumulative effects over time could moderately impact the environment. There is an information need to quantify the cumulative effects.

Fuel is of concern because of the volume that is carried on vessels, measured in tens of tons for larger vessels. The vast majority of spills are small (less than 7 tons); larger spills have been occurring with decreasing frequency since the 1970s (Talley 2003) a testament to increasing safety standards. Further, this improvement in safety has occurred against the backdrop of significantly increased oil extraction and transport activities (Coleman et al. 2003). In comparison, natural seepage contributes 61% of the total petroleum input to U.S. waters (Coleman et al. 2003); thus vessel-related spills are relatively less significant in Coastal California.

Lubricating and hydraulic fluids are typically oils with function-specific physical characteristics. They are not typically carried in large quantities unless they are being transported for distribution. Ocean vessel machinery may leak small amounts of oil from hydraulic or lubricating systems. These discharges will frequently make their way to the ocean before the crew is aware of them. The effect of these discharges is likely negligible to minimal.

Cleaning agents generally are soap and solvents. Soaps for use on ocean-going vessels tend to be formulated to be biodegradable and pose little threat to the marine environment. Solvents can also be formulated to be biodegradable, such as orange-based products. However, biodegradable solvents are not always effective for some applications and petroleum-based solvents are often necessary. Even in the event of a small discharge of these solvents, the impacts would be small.

Paints on vessels may include antifouling paint, interior paint and exterior paint, typically for metal surfaces and for maintenance purposes only. The amounts on vessels would be very small and their impacts, if released, would be negligible based on volume.

Human discharges are kitchen and septic waste. Both wastes consist primarily of water but the septic waste may contain treatment chemicals, pathogens and nutrients. Discharges are most likely to create between negligible and minimal impact categories.

Seagoing vessels are a significant source of NO_x , contributing more than 10% of the global tropospheric budget; surface NO_x concentrations in heavily traversed ocean regions are 100 times higher than background (Lawrence and Crutzen 1999). The authors modeled this NO_x source and found it significantly increased surface ozone and hydroxyl radicals. A side effect of this higher ozone and OH was a predicted decrease in methane concentrations. Their model, however, considered typical coastal marine hydrocarbon burdens, which clearly is inappropriate for the Coal Oil Point seep field and other areas of hydrocarbon seepage along the California coasts, where natural hydrocarbon emissions can combine with NO_x to create significant ozone. For example, based on natural oil emission estimates for the Santa Barbara Channel seeps of 100 bbl/day (Clester et al. 1996) and a 30% volatile component plus the non-methane hydrocarbon component for the estimated emission of 100,000 m^3 seep gas per day (Hornafius et al. 1999), total reactive organic gas (ROG) is 35 ± 7 tons per day or 43% of Santa Barbara County's ROG budget of 80.4 tons in 1999 (Santa Barbara County Air Pollution Control District 1994).

In Santa Barbara County, NO_x emissions from shipping are estimated to contribute more than 60% of the total NO_x inventory (Murphy et al. 2003). Because much of the NO_x is emitted by a few vessels, significant improvements can be achieved through focused regulatory activities, encouraging the use of catalytic agents to the exhaust fumes through differential port fees, or emission reduction credits.

Because shipping vessels remain in the shipping lanes which tend to be in international waters (the obvious exception being when approaching port), accidental or intentional oil spills will be at a distance of tens of kilometers offshore. Further offshore, the environmental impact generally will be smaller than for a similar spill closer to shore where water is shallower and there is less potential for evaporation, dispersion and dilution. Dilution is important particularly for the more toxic, volatile and soluble components (Engelhardt 1987). The processes governing all but massive oil spills in the shipping lanes will be similar to those governing oil from natural seeps. In general, currents are largely along shore, thus it is the seabreeze that pushes oil toward shore. As a result, oil will tend to move toward shore in the afternoons, and offshore at night (Del Sontro et al. 2007). Moreover, in general, because of the distance to shipping lanes (depending on the spill size) the more toxic and volatile components will be reduced, potentially significantly, before the oil arrives near shore. This does not apply for coastal enclosed waterways and harbor spills such as the Cosco Busan Spill in November 2007 in San Francisco Bay.

Because of the general shift in recent years toward heavier crude oils, increased vessel transport will increase the risk of accidental releases of dense oil that may sink to the bottom or break into oil droplets that rise very slowly (Spaulding et al. 1999). While the processes governing surface oil slicks have been studied for decades, research on the weathering and transport processes of sinking oil are largely unstudied, particularly oils denser than seawater. Submerged oil may resurface and/or wash upon shorelines, e.g., the Motor Vessel Braer disaster 1993 (Thorpe 1995) or remain submerged as in the Tanker Barge DBL-152 offshore of Louisiana in 2005 (Beegle-Krause et al. 2006). Some literature has investigated the surface submerged droplet size distributions, reported to be primarily between 1 and 70- μm at sea with a mean diameter of 20 μm (Li and Garrett 1998). In a flume tank, (Delvigne and Sweeney 1988), found a larger mean diameter of 100 -170 μm with a dependency on viscosity. Oil “puddles” on the sea bottom from the DBL-152 were centimeters thick.

17.4 SUBSEA PRODUCTION

Longitudinal studies of seepage show that the relationship between geology and seepage is complex (Leifer et al. 2009a). Although the underlying driving force is the pressure in the reservoir layer and the resistance to the seabed along the migration pathways, changes in hydrostatic pressure at one place in the reservoir only affects other portions of the reservoir that are connected. Thus, while a decrease in emissions at Platform Holly has been documented as related to production (Quigley et al. 1999), which mirrored seepage trends at the nearby Seep Tent seep 1982 through 2000 (Boles et al. 2001), emissions have increased since, indicating greater complexity. Moreover, sonar surveys suggest inshore seepage has not been affected by the same processes affecting seepage at Platform Holly (Leifer et al. 2009b). These observations simply demonstrate that the relationship between extractive activities and seepage are complex.

Additional complication arises from fluid re-injection to wells to prevent reservoir layer collapse and damage. Collapse of the reservoir layer would disturb in-layer migration, potentially reducing production, and possibly causing seabed subsidence. Seabed subsidence would have the potential to create new high-permeability pathways from the reservoir to the seabed, leading to new seepage or even a blowout.

Where seepage is decreased due to extractive activities, there will be a loss of chemosynthetic energy input into the environment. Virtually no studies have been conducted on chemosynthesis in the vicinity of seeps in shallow (photic zone) waters, although the oasis nature of deep sea chemosynthetic communities (MacDonald et al. 1986) and work on microbial communities suggests shallow water seepage provides a bioavailable energy source. Anecdotal evidence also suggests a role based on frequent observations of fish schools in the vicinity of seeps; however, data is completely lacking. Also, because seepage creates structures on the seabed (pockmarks, pits), decreased seepage would reduce the amount of these structures, decreasing habitats. Studies have showed bioadaptation at different trophic levels to petroleum hydrocarbon toxicity (La Montagne 2004; Spies and Davis 1982). Because the bioadaptation is unlikely to be uniform across trophic levels, decreasing petroleum hydrocarbons in the environment likely would shift the species distribution and numbers in coastal ecosystems.

17.4.1 Sediment Displacement

Where human activities cause seabed sediment displacement, displaced material will be re-introduced into the water column. Where sediments are contaminated with pollutants, re-suspension of these pollutants will allow them to impact the ecosystem (Murphy et al. 2003). The most significant impacts are from heavy metals, [discussed in section 17.4.1.1](#).

Considerable natural hydrocarbons can be found in sediments near seeps (Leifer et al. 2004). Extensive areas of these naturally hydrocarbon-containing sediments can be found down-current from the seeps. For example, seep hydrocarbons from the Coal Oil Point seep fields can be found tens of kilometers to the west (Farwell et al. 2009). Seabed disruption activities in areas of sediments with deposited seep hydrocarbons will re-introduce this material to the environment unless precautions are implemented successfully, potentially caused hydrocarbon exposure to the local biota that would not have occurred in the absence of these human activities. Although the most toxic components of the petroleum hydrocarbons will have been weathered, exposure of fish to sediment containing tar from Shane Seep in the Coal Oil Point seep field showed increased DNA damage (Roy et al. 2003).

17.4.1.1 Heavy Metals and/or Hydrocarbons

The potential for contaminant mobilization caused by sediment disturbance from anchoring during platform removal processes was discussed by MMS (2001) and by Schroeder and Love (2004) who hypothetically considered damage to soft sediment communities from anchors and associated ground tackle and from dragging platform legs if the jacket is removed using progressive transport. While not explicitly mentioned, it is also possible that sediment resuspension (and concomitant contaminant mobilization) could occur during the wellhead, casing, and conductor removal from below the sea floor by being pulled, cut off, or removed using explosives. Decommissioning and removal operations are considered in depth in the

proceedings of a public workshop edited by Manago and Williamson (1997). MMS (2001) estimated that approximately 11 days would be required per well for abandonment activities in the Pacific Outer Continental Shelf (OCS). Therefore impacts from resuspended sediments resulting from decommissioning activities are expected to be relatively short-lived. If the sediments include large percentages of silt, clouds of resuspended sediment can arise in the water column. However, only transient impacts to water quality are expected either vertically or horizontally since these silty sediments will likely settle back to the bottom within 500 m (USDOI, MMS 2001). In such instances, the primary water-quality parameter affected by suspended particulate material would be localized increases in turbidity. No data are available on the release of dissolved-phase constituents to the water column from such operations. Barium distributions in bottom sediments around the 4H shell mounds were believed to be a result of episodic disturbances during platform removal (or subsequent trawling by fishermen in the area) rather than ongoing erosion and dispersion of shell mound solids by near-bottom currents (Phillips et al. 2006).

Other than the general reviews cited above, very few recent papers were found on sediment displacement and how it might affect heavy metal and hydrocarbon redistributions in the Southern California OCS. Lissner et al. (1991) examined the effects of disturbances from anchoring and increased sedimentation (e.g., from discharges of drilling muds and cuttings) in deepwater (e.g., 60 to 300 m) hard-substrate communities. Recolonization and recovery in deep water environments were expected to vary in accordance with current models of succession (i.e., inhibition, facilitation, and tolerance). Inhibition responses were expected to predominate in high relief (e.g., greater than 1 m) areas where regrowth from margins is often possible by sponge taxa. Recovery of low relief (e.g., less than 1 m) areas also may be influenced primarily by inhibition responses, but the relative lack of nearby colonizers suggests greater numbers of species interactions in accordance with facilitation and tolerance models. This is a result of the greater stochastic component associated with recolonization by long-range larval dispersers. Recovery is expected to require several years to accomplish for these deepwater, hard-substrate communities. This is based on estimated times for recovery of slow-growing, generally long-lived taxa of many high-relief areas, and the uncertainties of long-range recruitment coupled with variable sediment movement in low-relief areas.

17.4.2 Bottom Debris

Bottom debris consists of materials abandoned and resting on the seabed, including structural materials (cable, tools, pipe, drums, platform pieces), construction materials (tools, wire clippings, nuts, bolts) and other trash (paper, plastic, wood, glass, and metal). Most trash is associated with providing food for workers (galley, offshore food service, Styrofoam cups), supplies (shipping pallets, drilling mud and chemical containers), and protective coverings (shrink wrap, pipe-thread protectors) and personal equipment (hard hats, personal floatation devices (PFD)). Trash can be managed by improving waste management practices and training workers. Structural materials pose the greatest threat of contamination by toxics, including metals.

17.5 OPERATIONAL DISCHARGE

17.5.1 Treatment, Workover, and Completion (TWC) Fluids

Three reports have been compiled on the chemicals used in the Gulf of Mexico and the North Sea addressing the nature of these chemicals and available data on aquatic toxicity (Hudgins 1985; Hudgins 1989; Hudgins 1991). Treating chemicals can generally be classified into three categories:

- Production-treating chemicals (scale inhibitors, corrosion inhibitors, biocides, emulsion breakers, and water treating chemicals, including reverse emulsion breakers, coagulants, and flocculants)
- Gas-processing chemicals (hydrate inhibitors, dehydration chemicals, and occasionally H₂S removal chemicals)
- Stimulation and workover chemicals (mineral acids, dense brines, and other additives).

As summarized by Stephenson (1992), production treating chemicals can be used in either continuous or batch treatment modes. In the batch treatment mode, a large amount of chemical (e.g., scale inhibitors, corrosion inhibitors, and biocides) may be injected into the well, and when the well is returned to production, a large slug of fluid containing high concentrations of these fluids is immediately generated along with the produced water. Generally, in this mode, the concentration of chemical exceeds toxic levels. To prevent an environmental impact, this first slug is captured separately from the basic production stream. In multi-well production systems, the slugs of chemicals are diluted significantly by production from other wells. In the continuous treatment mode, the levels of these chemicals in the produced water stream are generally not at toxic concentrations. Other chemicals that may have an environmental impact if they are discharged with produced water include hydrate inhibitors (e.g., methanol), treatment acids, and dense workover brines (e.g., zinc bromide). Acids are captured separately and neutralized, toxic brines are captured and reconditioned for reuse, and hydrate inhibitors are used at minimal levels. When used properly in the production process, these chemicals do not have adverse effects on the environment (Stephenson 1992).

Much of the data on process chemicals is considered proprietary; however, Tibbetts et al. (1992) identified several components in process chemicals used in the North Sea. The demulsifiers contained cyclic propoxylates, aniline, amine oligomers, and decahydrophenazine. Scale inhibitors contained diethylenetriamine, pentamethylene, phosphoric acid, and numerous other unidentified compounds. Corrosion inhibitors contained quaternary amines, N,N-dimethylamine, and other unidentified constituents. Biocides contained quaternary amines and N,N-dimethylamine. Aqueous degreasers contained diethanolamine, cyclic ethoxylates, C₁₀ to C₁₈ ethoxylates, aliphatic acid ethoxylates, nonylphenoethoxylates and alkylbenzene sulphonates. Because these constituents are used intermittently and are highly diluted by the much higher produced water volumes before discharge, they are not expected to contribute to significant water-quality impacts. In fact, their final concentrations in produced water samples

are often so low that analytical determination in produced water samples can be problematic (Tibbetts et al. 1992).

Although his studies were not strictly confined to chemical additives, Holdway (2002) concluded that the temporal and spatial scales and the large levels of inherent variation in natural environments have precluded our ability to predict the potential long-term environmental impacts associated with discharges from the offshore oil and gas production industry. Additional discussions on drilling muds, drill cuttings, and produced waters appear in [sections 17.5.2](#) and [17.5.3](#).

17.5.2 Drilling Muds and Cuttings and Subsequent Increase in Turbidity

An extensive 1993 review (Dailey et al. 1993) stated that studies on the effects of drilling fluids indicate that their toxicity is directly related to petroleum components, particularly diesel fuel (Neff and Anderson 1981; Conklin et al. 1983). The results of acute and sublethal toxicity testing and field studies on both drilling fluids and produced waters were extensively reviewed by the National Academy of Sciences (National Research Council (NRC) 1983) and Neff (1987). Since the 1993 review, there have been several papers on the impacts of drilling muds on marine environments (Hyland et al. 1994; Steinhauer et al. 1994; Raimondi et al. 1997; Parr et al. 2007). Three of these studies are specific to the Southern California OCS.

Hyland et al. (1994) conducted a 4-year study to assess potential impacts on the benthos from oil development off Point Arguello, California. Between October 1986 and October 1990, a total of 1.12×10^7 kg of drilling muds, including 5.73×10^6 kg of barite, was discharged from three platforms in the study area. Synoptic measurements were made using a number of biotic and environmental variables in both soft and hard bottom substrates. Fluxes of drilling muds calculated from excess concentrations of barium in sediment traps approximated those derived from trajectory modeling of the platform discharges, both indicating peak fluxes of 400 to 500 mg/m²/day of drilling solids within 11.5 km of Platform Hidalgo. Four of 22 hard-bottom taxa showed significant reductions in mean abundances at high flux stations after drilling began. Concentrations of chemical contaminants in suspended particles associated with the drilling discharges were below toxic concentrations, suggesting that any biological changes due to drilling muds were related to physical effects of the increased particle loading (e.g., disruption of feeding or respiration, or burial of settled larvae).

In connection with the Hyland study, Steinhauer et al. (1994) examined concentrations of trace metals and petroleum hydrocarbons in surface sediments and in suspended particulate material traps before, during, and after drilling. Barium was the only chemical to change significantly during the study period. During drilling, barium concentrations in surface sediments increased 30 to 40 percent above background. After drilling stopped, barium concentrations decreased, but after 1.5 years had not approached background concentrations. In the suspended sediment traps, barium concentrations increased 200 to 300 percent during drilling, but returned to background concentrations within one year after drilling had stopped. Hydrocarbon concentrations in the sediments were occasionally elevated but were not generally consistent with drilling activities. Natural seepage rather than drilling discharges was believed to be responsible for the randomly elevated hydrocarbon concentrations observed. During peak drilling periods, neither barium nor

petroleum hydrocarbons were detected in concentrations that were believed to be likely to impact benthic biota in the vicinity of the drilling platforms.

In a series of laboratory studies, Raimondi et al.(1997) examined the effects of drilling muds from an active platform off Southern California on fertilization, early development, survivorship, and settlement on red abalone (*Haliotis rufescens*) and adult survivorship, liability, and tissue loss on adult brown cup corals (*Paracyathus stearnsii*). Exposures to drilling muds did not have an effect on abalone fertilization or early development. However, several exposures to drilling muds resulted in weak but significant positive effects of drilling muds on settlement of competent larvae. In contrast, settlement of red abalone larvae on natural coralline algal crusts decreased with increasing concentrations of drilling muds. This suggests that drilling muds affect either the abalone's ability to detect natural settlement inducers or that they affect the inducer itself. Exposure of brown cup corals to concentrations of drilling muds adversely affected their survivorship and viability. These effects were likely caused by increased tissue mortality of the coral polyps. Significantly, the use of environmentally realistic test concentrations (0.002 to 200 mg/L) indicated that the effects found in the laboratory were of the same magnitude as those likely to occur in the field.

As noted above in the discussion of treatment, workover, and completion (TWC) fluids, Holdway (2002) completed a review of the acute and chronic effects of produced water, drilling muds (including oil-based, water-based, and ester-based cutting muds), chemical additives, and crude oils associated with offshore oil and gas production. Several of the reviewed studies on produced waters were specific to the Southern California OCS; they are considered in more detail below. The studies of acute and chronic toxicity of drilling mud reviewed by Holdway did not specifically include work from the Southern California OCS, but they did include several temperate marine organisms relevant to the study area: plankton communities, benthic communities, pelagic communities, and seagrass beds. Because of the variety of chemical components in drilling muds and their variation in both percentage composition and inherent acute toxicity, Holdway concluded that there is a potential for large variations in toxicity between different muds. There is even less information regarding the chronic or long-term toxicity of recent-generation drilling mud formulations, but sublethal effects of chromium or ferrochromium lignosulfonate-based drilling fluids on 35 species of marine organisms were reported in earlier literature (NRC 1983).

With regard to the effects of increased turbidity associated with drilling mud discharges, Holdway (2002) summarized work by Gordon et al. (1992), Muschenheim et al. (1995), and Muschenheim and Milligan (1996) examining the effects of various components of drilling muds suspended in the benthic boundary layer (BBL). In laboratory studies, these authors simulated physical conditions that exist in the BBL to examine effects of drilling muds on sea scallops (*Placopecten magellanicus*) from Georges Bank in the North Atlantic Ocean. Adult scallops had very low tolerance to suspended clay, and concentrations as low as 0.5 mg/L (ppm) of barite had significant detrimental effects on adult scallop growth (Gordon, Cranford et al. 1992). Recent studies of fine drilling waste particulates on the Scotian Shelf in Canada have shown that transient retention of drilling wastes in the BBL can develop over periods that are ecologically significant and that they may remain suspended in the BBL and detectable several kilometers

from the discharge point (Muschenheim et al. 1995; Muschenheim and Milligan 1996). The authors recognize the limitations of the laboratory exposures in representing actual field exposure conditions, and they noted that development of a high-energy exposure protocol to provide more ecologically relevant sedimentary and current conditions was appropriate. By way of confirmation, Holdway (2002) also suggested that long-term impacts might be occurring in this zone, despite the fact that studies to date were limited in scale and that their conclusions were uncertain relative to their environmental significance.

There was one paper (Vermaat et al. 1997) on the capacity of seagrasses to survive increased turbidity and siltation. However, these are intertidal or nearshore subtidal species, so the findings are unlikely to be relevant to effects of deeper water drilling mud discharges.

17.5.3 Produced Waters

During oil production, a well produces an emulsion of oil and water with gas in solution. Produced water is the largest volume waste stream in the exploration and production process. In offshore production operations, these emulsions are sent to a tank on board the platform for separation of the gas, which is used for fuel, sent ashore, or reinjected into the underlying formation. The emulsion may be transported by pipeline to shore for treatment, or some or all processing may occur on the platform. Over the economic life of a producing field, the volume of produced water can exceed by 10 times the volume of hydrocarbon produced. During the later stages of production, it is not uncommon for produced water to account for as much as 98 percent of extracted fluids (Stephenson 1992).

Processing of extracted fluids on the offshore platforms includes removal of impurities and produced water to yield an oil of sufficient quality to be injected into the pipeline for transport to an onshore refinery. Water removed from the emulsion at the platform can be injected back into the well or discharged overboard in accordance with EPA National Pollutant Discharge Elimination System (NPDES) permits. Water removed onshore can be injected onshore or sent to a platform offshore for injection or overboard discharge. All discharges are tracked through quarterly Discharge Monitoring Reports required by the NPDES permits. Offshore platforms in the Pacific OCS may discharge up to 330 million gallons of produced water in any year (USDOI, MMS 2001).

Produced waters contain metals and dissolved hydrocarbons that must be reduced as much as possible before the effluent can be discharged to the sea. Contaminants include sparingly soluble organics including: straight chain, branched, saturated, and cyclic fatty acids and monocyclic aromatic hydrocarbons (benzene, toluene, ethylbenzene, and xylene). Lower-solubility constituents include: a variety of other higher-molecular-weight aromatic and aliphatic compounds (often present as colloidal suspensions); trace quantities of dissolved metals such as arsenic, barium, chromium, cadmium, copper, zinc, mercury, lead, and nickel; and some inorganic compounds such as cyanides and sulfides (Brown et al. 1992; Neff et al. 1992; Rabelais et al. 1992; USDOI, MMS 2001). Naturally occurring radioactive elements, radium-226 and radium-228 have also been reported at trace concentrations in produced water from the North Sea, U.S. mainland terrestrial sites, and offshore wells in Louisiana and the Gulf of Mexico (Meinhold and Hamilton 1992; Mulino and Rayle 1992; Rabelais et al. 1992; Rayle and

Mulino 1992). While the levels in produced water samples from the Mississippi River deltaic plain were variable, Rabalais et al. (1992) reported that the radioactivity associated with the produced water was found to originate with the radium isotopes (two-thirds coming from radium-226) and not the radioactive parents. The total radium activities were 150 to 1,150 times higher than in natural waters, and all discharges sampled had total radium activities, which were in excess of 111 dpm/L, an activity level designated by the U.S. Environmental Protection Agency as hazardous waste (Reid 1983). Total radium activities in these produced waters correlated positively and strongly ($R^2 = 0.805$) with salinity of the effluent (Neff, Sauer et al. 1992). Notwithstanding these data from produced waters generated elsewhere, no data on radioactive elements in produced waters from offshore California wells were found.

Various mechanical treatment processes include heat, corrugated plates, electrostatic precipitation, bubbling, and chemical means (Ray and Englehardt 1992; Reed and Johnsen 1996)

Since NPDES permits allow some dissolved components of oil to remain in the produced water effluent (currently ranging from 29 to 72 ppm in the Pacific OCS Region), some amount of oil is discharged into the sea with this effluent. The concentrations for all the components (except temperature) are high relative to the ambient characteristics of the receiving water. However, the EPA allows dilution of the regulated components in the effluent (except oil and grease) in a mixing zone of 100 m radius from the discharge, at which point the calculated concentrations in effluent must meet the permit limits.

Availability of Discharge Monitoring Reports (DMRs) generated to support each operator's NPDES permit is spotty in the Southern California OCS region before 1988, and they include only a few records from a few platforms (USDOI, MMS 2001). Since 1988, a more complete data set indicates that operators have met the terms of their NPDES permits (Panzer 1999; USDOI, MMS 2001). [Table 17.1](#) (Table 6.2.2-1 from MMS (2001)) shows the number of platforms in the Pacific OCS region and how many discharged produced waters at the specified oil and grease limits for the number of years shown between 1989 and 1998. That is, some platforms discharged produced waters for all 10 years, while others did not (e.g., 3-7 years).

Table 17.1.

Platforms Discharging Produced Waters in Southern California

Table 6.2.2-1. Platforms that have discharged produced water, the number of years discharging and the NPDES permit limit for oil and grease.

Platform	Years Discharged (1989 - 1998)	NPDES Oil and Grease Permit Limit (ppm)	Platform	Years Discharged (1989 - 1998)	NPDES Oil and Grease Permit Limit (ppm)
Edith	10	72	C	8	72
Gail	10	29	Harmony	7	29
Gilda	10	72	Harvest	7	72
Habitat	10	72	Hidalgo	7	72
Hogan	10	72	Hermosa	7	72
Hillhouse	10	72	Grace	6	29
A	10	72	Gina	4	72
B	10	72	Irene	3	29

Source: USDOl, MMS (2001)

An estimate of the total number of barrels of dissolved and colloidal oil discharged in the produced water effluent by all platforms in the Pacific OCS region between 1989 and 1998 is 492 barrels (from the 30 ppm discharge), 821 barrels (from the 50 ppm discharge) and 1183 barrels (from the 72 ppm discharge) (USDOl, MMS 2001). More recently, Steinberger et al. (2005) compared the statistics from the 23 oil platforms currently operating offshore of Southern California. The data from the NPDES discharge monitoring reports were used to quantify oil platform discharges to the SCB in 1996 and 2000 in terms of total volumes discharged, contaminant loading, and average discharge constituent concentrations. Results of this evaluation were compared with an assessment conducted in 1990. Results were also compared to discharges from large and small wastewater treatment facilities (publicly owned treatment works, or POTWs) to gauge the relative contribution of oil platform discharges to the SCB. In 1996 and 2000, oil platforms discharged 5,374 and 5,638 million liters of produced water and 12,128 and 2,955 metric tons (mt) of solids to the SCB, respectively. Oil platform discharges were minor compared with effluents from large and small POTWs in terms of both volume and constituent mass emissions.

17.6 EFFECTS OF PRODUCED WATER DISCHARGES

In the 1993 review (Dailey, Reish et al. 1993), brief mention was made of produced water studies in a shallow low-salinity lagoon in Trinity Bay, Texas; however, the authors cautioned that results from those studies should not be extrapolated to operations in the SCB. Additional data are now available from two international symposia held in the early to mid-1990s on produced water issues (Ray and Englehardt 1992; Reed and Johnsen 1996); and a book specifically examining the bioavailability and marine ecotoxicology from contaminants in produced waters from around the world has been published (Neff 2002). Several papers from the two produced water symposia were cited in the Draft EIS for Delineation Drilling Activities in Federal Waters Offshore Santa Barbara County, California (USDOl, MMS 2001), and more

detailed summaries of these and other recent findings on produced water composition and impacts specific to Southern California Bight waters are presented below.

The EPA allows dilution of the regulated components (except oil and grease) to a 100-m radius, at which point the calculated effluent concentrations must meet the NPDES permit limits. Calculated produced water dilution ratios in the SCB range from about 500:1 to nearly 2500:1 (USDOJ, MMS 2001). That is, any value of a monitored produced water parameter measured on the platform will be divided by 500 to 2,500 to determine compliance with the permit. While this does not address potential impacts within 100 m of the discharge point, it does help to ensure that water quality limits are not exceeded beyond 100m. These dilution factors are similar to those cited from some models developed to calculate dilutions for the purpose of determining compliance with NPDES permits (Brandsma et al. 1992; United States Environmental Protection Agency (USEPA) 2000; Ekins et al. 2005) and significantly less than site-specific modeled dilutions predicted at a distance of 1000 m in others (Washburn et al. 1999). Washburn et al. (1999) compared modeled plume behavior with the biological effects studies (discussed further below) completed near the produced water diffuser outfall in the Santa Barbara Channel near Carpinteria. Modeled plume behaviors were affected by seasonal water column stratification: In spring and summer, it was trapped below the surface, and in fall and winter, it extended over most of the water column. At 1000 m from the outfall, the farthest test sites considered in the biological studies discussed below, minimum modeled dilutions ranged from 4,000 to 40,000. These estimates exceed the threshold for sublethal effects on sea urchin fertilization (Krause et al. 1992; Krause 1993) by 100 to 1000.

To assess possible causes for variability associated with different produced water toxicity tests, Schiff et al. (1992) completed a study to evaluate: (1) produced water sampling and handling procedures and sample changes during storage; (2) different toxicity testing procedures using the mysid, *Mysidopsis bahia*, with produced water; and (3) the suitability of other test species in toxicity testing with produced water. For the sampling and sample storage component of the tests, samples were obtained from an onshore processing and treatment facility in California that received produced water from offshore platforms. Because of high microbial activity in those particular produced water samples, however, that facility not used in later toxicity tests. Samples for toxicity testing originated from offshore platforms located in the Mississippi Delta, Gulf of Mexico. The authors concentrated on volatile BTEX (benzene, toluene, ethylbenzene, and xylene) compounds for the sample stability portion of the program and concluded that sample integrity could be sustained long enough for biological testing and chemical analyses over an 8-day period when the samples were stored in the dark with no headspace at 4°C. No single chemical constituent could be strongly correlated with the toxicity observed during the multi-species comparative tests.

Osenberg et al. (1992) completed one of the first studies examining the spatial scale of environmental effects of produced water discharges on the high-energy coastal habitat near Carpinteria, California. The study was unique in that it took place in the absence of other production activities and structures. Study objectives were to: (1) look for discernible biological effects in a high-energy environment, (2) document the nature of the effects, and (3) compare the spatial extent of impacts on infaunal densities with effects on growth and body condition of

outplanted (caged) mussels. The water column depth was 10 to 12 m, and produced water was discharged 0.75 m above the bottom. Associations between infaunal densities were observed with three environmental parameters: distance from the outfall, particulate organic matter (POM), and percent silt-clay. Distance from the outfall had the strongest effect. Nematodes achieved greater densities near the outfall, while other organisms (echinoderms, larval crustaceans, and several polychaete families) exhibited the opposite pattern and achieved greater densities further from the outfall. A third group, including bivalves, two classes of crustacea and two polychaete families, exhibited a mixed pattern where densities were generally positively associated with POM, and occasionally were more abundant near the outfall. The most significant impacts were observed at distances less than 10 m from the outfall, and most organisms resumed normal densities around 100 m. Changes were asymmetric in an east-west direction, suggesting the influence of dominant currents. Survivorship of outplanted mussels was relatively high and showed no significant correlation with distance from the outfall; however, shell growth and sublethal effects (site-specific gonadal and somatic tissue masses) were all positively correlated with distance. Mussel performance was reduced out to a distance of at least 100 m and perhaps beyond 1 km. No samples were available between 100 m and 1 km, and no samples were available beyond 1 km. Mussels near the produced water outfall tended to grow more slowly and at any given size were in poorer condition. Infaunal impacts appeared to be due to contaminants that settled to the benthos, while waterborne (dissolved-phase) contaminants were believed to have caused effects to the outplanted mussels over a much greater spatial scale than did the particulate fractions. As described below, an area of effect of similar size was also observed at Carpinteria for performance of abalone larvae (Raimondi and Schmitt 1992).

In a companion study, Raimondi and Schmitt (1992) undertook field and laboratory experiments to determine if discharged produced water from the Carpinteria facility could adversely affect planktonic larvae by examining (1) the relationship between proximity to discharge, duration of exposure, and the probability of a larva surviving, settling, and metamorphosing; and (2) whether effects differed for larvae of different developmental stages. The pattern of survivorship in relation to the diffuser distance differed substantially between two developmental stages: survivorship of pre-competent larvae increased with distance from the diffuser; only about half of the initial cohort survived out to 10 m, and a substantial reduction (30 percent) in survivorship was apparent out to 100 m. By contrast, survivorship of competent abalone larvae was unaffected by distance from the diffuser, and more than 80 percent survived at all stations, even at 5 m from the outfall. The stage of development during exposure to produced water also affected subsequent settlement success. The settlement ability of surviving pre-competent larvae was impaired, whereas exposed competent larvae were not affected. However for competent larvae, settlement in the field did vary with distance transplanted from the diffuser with the magnitude of the effect decreasing from the outfall. Reductions in settlement success were apparent as far away as 50 to 100 m. The fraction of settled larvae (in the field) that completed metamorphosis increased with distance from the diffuser, but that distance was less than the distance effect on settlement. The greatest reduction in metamorphosis was observed for sites 5 m east and west of the outfall. Overall viability (proportion of individuals surviving from larva through adulthood) was also related to distance from the diffuser. Reductions of 20 to 30 percent were apparent as far as 100 m from the outfall, with the greatest depressions occurring in the 5 m

distance sites where nearly 80 percent of the initial cohorts failed to make the transition to the adult body form. As with the other tests in this study, impacts were qualitatively similar on both sides of the diffuser. Swimming behavior of larvae was also affected at least out to 100 m. Viability of larvae that resided within 10 m of the diffuser for 4 days was greatly reduced, with 80 percent of the cohort failing to complete metamorphosis. Even brief exposure resulted in a sizable reduction in settlement success. Larvae exposed to produced water stopped swimming, and only returned to normal behavior slowly after exposure ceased. Abalone larvae are negatively buoyant and must actively swim to remain in the water column; the consequence to planktonic larvae that prematurely sank to the bottom is unknown. Overall the results indicate that planktonic larvae can be affected adversely by produced water plumes, even from discharges in high-energy, open coastal environments.

In a separate but related laboratory study with produced water and mussels from Carpinteria, Fan et al. (1992) used noninvasive ^{31}P spectroscopy and ^1H nuclear magnetic resonance (NMR) imaging to acquire unique molecular information on energy budgets and detailed morphological and biophysical changes during gametogenesis in mussels exposed to produced water. Both methods revealed the dynamics of chronic ovarian perturbations within the same individuals. The changes observed suggest that produced water exposure perturbed ovarian energy balance and caused ovarian degeneration. It was cautioned however that the study was completed with only one sample of produced water, and that produced water variability precluded a general conclusion on impacts of produced waters from other areas in the Santa Barbara Channel.

In another study examining the paradigm that earlier developmental stages of marine organisms are more sensitive to pollutants than are later ones, Krause et al. (1993) exposed eggs, sperm, and zygotes of the purple sea urchin (*Strongylocentrotus purpuratus*), together and separately, to different concentrations of produced water from the Carpinteria facility. The purpose of the study was to determine (1) the relative sensitivities of different life stages, (2) the nature of the biological response, and (3) the potential for delayed expression. The purple sea urchin broadcasts eggs and sperm into the water column, where fertilization and subsequent larval development then occur. It was found that a 1-percent concentration of produced water was not acutely toxic to sea urchin eggs or embryos. Regardless of life stage, 85 percent of the initial cohort survived up to 96 hours. By contrast, produced water greatly altered developmental rates of sea urchin embryos. Zygote exposure yielded the smallest effect, while sperm exposure had the greatest effect. The rank in sensitivity of life stages, from greatest to smallest, was: sperm, eggs, zygotes. The effect of one percent produced water on sperm viability was virtually instantaneous. Sublethal responses to produced water at concentrations as low as 1 ppm were detected. It was concluded that adult sea urchins that spawn in the vicinity of a produced water outfall are likely to produce offspring with delayed developmental rates, even though those developing larvae may be transported away from the outfall. The results further suggested that although produced water is rapidly diluted, detectable developmental effects can persist out to 100 to 500 m where produced water concentrations drop to approximately 1 ppm.

The response of young purple sea urchins, especially those arising from exposure of gametes, was believed to involve direct alteration of normal cellular activity. Similar effects have been observed for PCB exposure; however, the actual mechanism producing the effect is unknown. It

was suggested that lipid reserves are of primary importance in embryonic development, and larvae may shunt energy reserves away from differentiation to be used to detoxify such lipophilic contaminants. In addition to lipophilic compounds, effects are believed to be caused by water-soluble constituents including divalent cations. Barium and strontium are likely candidates that mediate their effects through modification of microtubule function, particularly in the sperm centriole. Other studies using produced water from the same source have found responses that might involve microtubule-mediated effects: e.g., swimming and chemoreception of abalone larvae (Raimondi and Schmitt 1992), migration of kelp nuclei (Pillai, Baldwin et al. 1990), and growth (and possibly feeding) of mussels (Osenberg, Schmitt et al. 1992).

In another study of sublethal effects, Wagner (1994) determined the Lowest Observed Effect Concentration (LOEC) for both survival and growth on two species of mysids (opossum shrimp), with produced water concentrations ranging from 0.18 to 10 percent of whole produced water effluent. These concentrations were believed to be representative of values expected within 100 m of any produced water discharge point in the offshore California OCS. The LOECs for survival ranged from 3.2 to 10 percent, while the LOECs for growth ranged from 0.18 to 7.00 percent. There was no indication of effects on survival until concentrations of at least 1.5 to 2.00 percent were reached (equivalent to dilutions of 150:1 to 200:1). Above that concentration, however, survival decreased significantly. While growth also decreased with increasing concentration, the changes began to appear at slightly lower concentrations than those observed for survival (around 1.0 to 1.5 percent). Wagner's test concentrations in terms of ratio dilutions, ranged from 180:1 to 10:1, which would be well within 100 m of a discharging platform, although it is unknown exactly how far that distance might be. Nevertheless, the results are instructive regarding the application of laboratory results to the field, and the distances from the discharge point at which observed effects might begin to occur.

As a final caveat it should be noted, however, that in all the Carpinteria field studies discussed above (Krause et al. 1992; Osenberg et al. 1992; Raimondi and Schmitt 1992), the water depth was only 10 to 12 m (33 to 40 ft), so the results may not be directly applicable to offshore platforms in deeper waters where the plumes could vertically disperse to a greater extent. No studies on produced water discharges from OCS oil and gas facilities have been conducted in deeper water.

Notwithstanding the studies cited above, Cherr and Fan (1997) stated that it is difficult to assign cause and effect relationships amid the background of natural variability, particularly in an environment such as the Santa Barbara Channel where multiple complicating factors are present. Such high levels of variation limit our ability to detect subtle impacts of contaminants. However, if the mechanism of action of toxicants under controlled laboratory conditions are better understood, as described in several of the papers cited above, the observed pattern of bioeffects in the natural environment can be more directly linked with specific contaminants. Additional studies of combined laboratory and field efforts are warranted in order to achieve scientifically valid information that is also environmentally relevant. Among the myriad effects that can be measured, gametogenesis and embryonic development are categories that deserve special attention because of their relevance to effects at the population level. A mechanistic understanding of contaminant effects on cellular functioning during gametogenesis and

embryonic development is generally unclear, and understanding this is required for linking laboratory effects with field observations. As pointed out by Holdway (2002), one of the most intriguing possibilities is the hypothesis of Krause et al. (1992) that all of the observed produced water effects could be mediated through a single unifying toxicological mechanism involving microtubule-mediated effects. It is rare in applied science such as ecotoxicology for such unifying theories to be proposed, thus designing additional experiments to critically test this proposed hypothesis would appear to be very useful.

From the above noted studies on laboratory bioassays with various dilutions of produced water, it is clear that sublethal effects can occur at anticipated concentrations within 100 m of any produced water discharge in the offshore California OCS. In addition, several studies suggested that sublethal biological processes may be affected at more far-reaching distances than EPA's 100 m regulatory limit. In addition, further research should include the study of produced water effects on zooplankton and embryo and larval fish survival in the surface microlayer (Holdway 2002). These studies indicate that more information is needed to ensure that produced water discharges do not change water quality parameters to the extent that biological systems are impacted. Additional studies are needed to provide better estimates of concentration and dilution with distance both from the discharge point both to 100 m as well as to points beyond 1000 m. Likewise, studies to determine radium-226 and radium-228 in California produced waters appear warranted.

None of the other effluents potentially discharged from exploration and production platforms are at concentrations that would cause any water quality impacts due to the small volume of the discharge and the treatment systems required.

17.7 AIR EMISSIONS

Atmospheric emissions associated with continued oil and gas activity in the study region are reasonably well established through the potential impacts of production on air quality that are included in EIS and other regulatory assessments. This is particularly true for the components leading to photochemical smog and ozone. Atmospheric emissions that have received less attention are those of long-lived gases such as methane and carbon dioxide, both potent greenhouse gases. These gases are likely to come under enhanced regulation and a detailed accounting of their emissions from continued offshore oil and gas activity, if feasible, seems warranted.

17.8 EFFECTS OF H₂S

The release of hydrogen sulfide gas is strictly monitored because of its immediate toxicity to humans, and because it is an air pollutant. Less attention has been paid to release in the ocean, either through drilling operations, well cuttings, produced waters or seepage. When released into the ocean at high concentrations, hydrogen sulfide is oxidized on the order of hours, with biological and chemical routes competing. Locations of chronic hydrogen sulfide release harbor dense communities of sulfide-oxidizing bacteria (Reed et al. 1994; Kalanetra et al. 2004; Ding and Valentine 2008). Hydrogen sulfide is present in the waters throughout much of the study

region, albeit at low nanomolar concentrations (Kuwabara et al. 1999). The impacts of low but sustained hydrogen sulfide levels are not well established and are worth additional consideration.

One publicly contested argument that has appeared extensively in the past decade is that offshore oil production reduces rates of natural petroleum seepage and can thus be considered as a factor mitigating impacts of offshore oil activity. Most of the debate has taken place in the media, with only two relevant studies appearing in the peer-review literature (Hornafius et al. 1999; Quigley et al. 1999). This issue requires additional scientific consideration because the existing evidence is insufficient to support the claims made by many proponents of the idea, that is, the relationship is an untested hypothesis. Specific questions that need to be addressed to assess these arguments are as follows: First, the relationship between production and seepage has been demonstrated only at Platform Holly, which sits in the largest oil seep in the study region, and perhaps the world. This relationship must be assessed at other platforms, and in a wider area around platform Holly, before it becomes accepted. Second, the local geology must be considered when applying this principle to other situations or locations; for example, many platforms in the study area appear to have no established seeps around them, thus arguments about natural seepage rates are moot. Third, any relationship between production and seepage is likely to apply only in the early history of an oil reservoir, when the pressure of the reservoir is greater than ambient. As secondary and tertiary extraction is applied, this simple relationship is likely to falter and seep flux could increase. Fourth, the casual observation that the reservoir underlying the COP seeps has been under production for decades, yet the seeps are still the world's most prolific, suggests that the full extent of reduction in seepage is not great when averaged over a wide area and a long period of time. Fifth, the actual environmental damage caused by chronic spills of heavy oil needs to be better assessed, particularly the question of whether biological communities are accustomed to or even benefit from the input of crude oil.

17.9 SUMMARY AND DATA GAPS

Leaching of biologically active chemicals (e.g. from paints and antifouling coatings), including butyltins (DBT, MBT and TBT), cadmium, copper, manganese, nickel, and zinc is a concern in coastal waters and sediments. Though studies have found exceedance of water quality criteria within marinas, these issues are not directly applicable to the more energetic and open OCS. Butyltins have been found in deeper sediments (458–906 m) by Venkatesan et al. (1998) indicating these chemicals can be distributed widely, and deeper sediments should be investigated. Boehlert et al. (2008) recommend baseline and monitoring studies of release rates and accumulation of copper, butyltin and potentially other trace metals in water, tissues, and sediment. Their report also stressed that monitoring for effects needed to include not just mortality but also changes in species abundance and movement. The development of less toxic and more specifically targeted antifouling chemicals is encouraged.

Additional details on discharges from active offshore production platforms worldwide are considered by Holdway (2002), and specifically for the SCB during 1996 and 2000 by Steinberger et al. (2005), who concluded that based on the total discharges and constituent concentrations, oil platform discharges were minor compared to effluents from large and small POTWs in terms of both volume and constituent mass emissions.

Prasthofer (1997) highlighted the approaches necessary to ensure containment and decontamination of oil, chemicals, and other potentially hazardous materials from platform topside facilities (vessels, tanks, pumps, and piping) during decommissioning and removal activities. Schroeder and Love (2004) identified the need for additional scientific data on the possible biological effects of any residual contaminants in surrounding sediments. Major issues identified include the likelihood that contaminated sediments are resuspended in the water column as well as damage to soft sediment communities.

In 1996, Chevron removed oil platforms Heidi, Hilda, Hazel, and Hope (the so-called 4H platforms) off the coast of Southern California near Summerland and Carpinteria, leaving behind massive mounds of mussel shells, approximately 200 feet wide and 20 to 30 feet tall (Camozzi 1997). Complete platform removal during decommissioning will lead to a local benthic species composition shift toward a soft sediment community (if the shell mound is removed) or to a community similar to one inhabiting areas with low-relief cobble (if the shell mound is left in place).

The negative effects of increased vessel traffic in the Southern California Bight include a higher risk of discharges and spills, leaching of bottom paints, and increased atmospheric pollution from ship exhausts. Repeated routine discharges from commercial vessels related to the oil and gas industry are likely to cause more adverse effects than much rarer oil spill events. Because of the general shift in recent years toward heavier crude oils, increased vessel transport will increase the risk of accidental releases of dense oil that sinks to the bottom or break into oil droplets that rise very slowly. While the processes governing surface oil slicks have been studied for decades, the weathering and transport processes of sinking oil are largely unstudied, particularly for oils denser than seawater (Spaulding, MacKinnon III et al. 1999). Thus the fate of spilled heavy oils such as those from the Monterey Formation represents a data gap. Bottom paints are used on all seagoing vessels, including commercial vessels. The effects of toxic chemicals leaching from the hulls of ships may pose a minor to moderate impact in enclosed areas. Ship exhaust fumes from engines powered by fossil fuels will release a variety of chemicals into the atmosphere. Exhaust fumes from fossil fuel engines significantly reduce air quality. There is an information need to quantify the cumulative effects.

Coal Oil Point seep field and other areas of hydrocarbon seepage along the California coasts are locations where natural hydrocarbon emissions can combine with NO_x to create significant ozone. In Santa Barbara County, NO_x emissions from shipping are estimated to contribute more than 60% of the total NO_x inventory (Murphy et al. 2003).

Where human activities cause seabed sediment displacement, displaced material will be re-introduced into the water column. Where sediments are contaminated with pollutants, re-suspension of these pollutants will allow them to impact the ecosystem (Murphy et al. 2003). The potential for contaminant mobilization caused by sediment disturbance from anchoring during platform removal processes was discussed by MMS (2001) and by Schroeder and Love (2004) who considered hypothetical damage to soft sediment communities from anchors and associated ground tackle and from dragging platform legs if the jacket is removed using progressive transport.

Tibbetts et al. (1992) identified several components in process chemicals used in the North Sea. Because these constituents are used intermittently and are highly diluted by the much higher produced water volumes before discharge, they are not expected to contribute to significant water quality impacts. In fact, their final concentrations in produced water samples are often so low that analytical determination in produced water samples can be problematic. An extensive 1993 review (Dailey et al. 1993) stated that studies on the effects of drilling fluids indicate that their toxicity is directly related to petroleum components, particularly diesel fuel (Neff and Anderson 1981; Conklin et al. 1983). Holdway (2002) concluded that the temporal and spatial scales and the large levels of inherent variation in natural environments have precluded our ability to predict the potential long-term environmental impacts associated with discharges from the offshore oil and gas production industry. Holdway also concluded that there is a potential for large variations in toxicity between different muds.

Produced waters contain metals and dissolved hydrocarbons that must be reduced as much as possible before the effluent can be discharged to the sea. Studies show clearly that sublethal effects can occur at anticipated concentrations within 100 m of any produced water discharge in the offshore California OCS.

Potential impacts to air quality from the atmospheric emissions associated with continued oil and gas activity in the Study Area are reasonably well established. Atmospheric emissions from long-lived gases such as methane and carbon dioxide, both potent greenhouse gases, have received less attention. The release of hydrogen sulfide gas is strictly monitored because of its immediate toxicity to humans, and because it is an air pollutant. Less attention has been paid to release in the ocean, either through drilling operations, well cuttings, produced waters or seepage. Hydrogen sulfide is present in the waters throughout much of the study region, albeit at low nanomolar concentrations. The impacts of low but sustained hydrogen sulfide levels are not well established and represent a data gap.

An issue of public interest is whether offshore oil production reduces rates of natural petroleum seepage and can thus be considered as a factor mitigating impacts of offshore oil activity. However, significant data gaps prevent a concrete assessment of this issue. Specific gaps include whether the observed relationship holds true for more than one platform studied to date, the effect of the underlying geology, and the impacts of multi-stage extraction and reservoir history on the modulation of seepage.

17.10 LIST OF LITERATURE CITED—CHEMICAL OCEANOGRAPHY

- Beegle-Krause, C.J., C. Barker and G. Watabayashi. 2006. Long-term Transport of Oil from T/B DBL-1529b: Lessons Learned for Oils Heavier than Seawater. Arctic Oil and Marine Pollution Conference Proceedings: Twenty-Ninth AMOP Technical Seminar, Environment Canada, 1003-1020.
- Boehlert, G., G. McMurray and C. Tortorici. 2008. Ecological effects of wave energy development in the Pacific Northwest: A scientific workshop, October 11-12, 2007. U.S. Dept. of Commerce, NOAA Technical Memorandum. NMFS-F/SPO-92: 174.

- Boles, J., J. Clark, I. Leifer and L. Washburn. 2001. Temporal variation in natural methane seep rate due to tides, Coal Oil Point area, California. *Journal of Geophysical Research-Oceans* 106(C11):27077-27086.
- Brandsma, M.G., J.P. Smith, J.E. O'Reilly, R.C. Ayers, Jr. and A.L. Holmquist. 1992. Produced water: technological/environmental issues and solutions. 1992 International Produced Water Symposium. J.P. Ray and F.R. Engelhardt. San Diego, California, Plenum Press, New York. 46: 59-71.
- Brown, J.S., T.S. Sauer, Jr., M.J. Wade and J.M. Neff. 1992. Chemical and toxicological characterization of produced water freon extracts. 1992 International Produced Water Symposium. J. P. Ray and F. R. Engelhardt. San Diego, California, Plenum Press, New York. 46: 113-131.
- Camozzi, N. 1997. Shell Mounds. Proceedings: Public Workshop, Decommissioning and Removal of Oil and Gas Facilities Offshore California: Recent Experiences and Future Deepwater Challenges. F. Manago and B. Williamson. Santa Barbara, CA, Coastal Research Center, Marine Science Institute, University of California. OCS Study MMS 98-0023.
- Cherr, G.N. and T.W.M. Fan. 1997. Chronic toxicological effects of produced water on reproduction and development in marine organisms. University of California Southern California Educational Initiative. Program Overview. March: 60-66.
- Clester, S.M., J.S. Hornafius, J. Scepan and J.E. Estes. 1996. Quantification of the relationship between natural gas seepage rates and surface oil volume in the Santa Barbara Channel, (abstract). EOS (American Geophysical Union Transactions).
- Coleman, J., J. Baker, C. Cooper, M. Fingas, G. Hunt, K. Kvenvolden, K. Michel, J. Michel, J. McDowell, J. Phinney, R. Pand, L. Rabalais, L. Roesner and R.B. Spies. 2003. Oil in the sea III: Inputs, fates, and effects. Washington DC: National Academies Press.
- Conklin, P.J., D. Drysdale, D.G. Dougtie, K.R. Rao, J.P. Kakareka, T.R. Gilbert and R.F. Shokes. 1983. Compared of toxicity of drilling fluids: Role of chromium and petroleum hydrocarbons. *Marine Environmental Research* 10:105-125.
- Culwell, A.S. 1997. Removal and disposal of deck and jacket structures. Public workshop, decommissioning and removal of oil and gas facilities offshore California: recent experiences and future deepwater challenges. F. Manago and B. Williamson. Santa Barbara, California: 48-65.
- Dailey, M.D., D.J. Reish, and J.W. Anderson. 1993. Ecology of the Southern California Bight: A synthesis and interpretation. University of California Press.
- Del Sontro, T.S., I. Leifer, B.P. Luyendyk and B.R. Broitman. 2007. Beach tar accumulation, transport mechanisms, and sources of variability at Coal Oil Point, California. *Marine Pollution Bulletin* 54(9):1461-1471.

- Delvigne, G.L. and C.E. Sweeney. 1988. Natural dispersions of oil. *Oil and Chemical Pollution* 4(4):281-310.
- Ding, H. and D.L. Valentine. 2008. Methanotrophic bacteria occupy benthic microbial mats in shallow marine hydrocarbon seeps, Coal Oil Point, California. *Journal of Geophysical Research-Biogeosciences* 113, G01015, doi:10.1029/2007JG000537.
- Ekins, P., R. Vanner, and J. Firebrace. 2005. Management of produced water on offshore oil installations a comparative assessment using flow analysis-Final Report.
- Engelhardt, F.R. 1987. Assessment of the vulnerability of marine mammals to oil pollution. *Fate and Effects of Oil in Marine Ecosystems*. J. Kuiper and W. J. V. d. Brink. Dordrecht, Lancaster, Boston, Martin Nijhoff Publishers: 101-115.
- Fan, T.W.M., R.M. Higashi, G.N. Cherr and M.C. Pillai. 1992. Use of noninvasive NMR spectroscopy and imaging for assessing produced water effects on mussel reproduction. 1992 International Produced Water Symposium. J. P. Ray and F. R. Engelhardt. San Diego, California, Plenum Press, New York. 46: 403-414.
- Farwell, C., C.M. Reddy, E. Peacock, R.K. Nelson, L. Washburn and D.L. Valentine. 2009. Weathering and the fallout plume of heavy oil from strong petroleum seeps near Coal Oil Point, CA. *Environmental Science & Technology* 43(10):3542-3548.
- Gordon, Jr., D.C., P.J. Cranford, D.K. Muschenheim, J.W. Loder, P.D. Keizer and K. Kranck. 1992. Managing the environmental impact of offshore oil production. The 23rd annual meeting of the Canadian Society of Environmental Biologists. P.M. Ryan. Newfoundland, Canada: 139-147.
- Holdway, D.A. 2002. The acute and chronic effects of wastes associated with offshore oil and gas production on temperate and tropical marine ecological processes. *Marine Pollution Bulletin* 44(3):185-203.
- Hornafius, J.S., D. Quigley, and B.P. Luyendyk. 1999. The world's most spectacular marine hydrocarbon seeps (Coal Oil Point, Santa Barbara Channel, California): Quantification of emissions. *Journal of Geophysical Research-Oceans* 104(C9):20703-20711.
- Hudgins, C.M. 1985. Chemical treatment of produced fluids in offshore oil and gas production systems. Report to American Petroleum Institute, Petrotech Consultants, Inc., Houston, Texas.
- Hudgins, C.M. 1989. Chemical treatments and usage in a offshore oil and gas production systems. Report to American Petroleum Institute, Petrotech Consultants, Inc., Houston, Texas.
- Hudgins, C.M. 1991. Chemical usage in North Sea oil and gas production and exploration operations. Report to Oljeindustriens Landsforening (OLF), Petrotech Consultants, Inc., Houston, Texas.

- Hyland, J., D. Hardin, M. Steinhauer, D. Coats, R. Green and J. Neff. 1994. Environmental impact of offshore oil development on the outer continental shelf and slope off Point Arguello, California. *Marine environmental research*. London 37(2):195-229.
- Kalanetra, K.M., S.L. Huston, and D.C. Nelson. 2004. Novel, attached, sulfur-oxidizing bacteria at shallow hydrothermal vents possess vacuoles not involved in respiratory nitrate accumulation. *Applied and Environmental Microbiology* 70(12):7487-7496.
- Krause, P.R. 1993. Effects of produced water on reproduction and early life stages of the purple sea urchin (*Strongylocentrotus purpuratus*): Field and laboratory tests.
- Krause, P.R., C.W. Osenberg, and R.J. Schmitt. 1992. Effects of produced water on early life stages of a sea urchin: stage-specific responses and delayed expression. 1992 International Produced Water Symposium. J.P. Ray and F.R. Engelhardt. San Diego, California, Plenum Press, New York. 45: 431-444.
- Kuwabara, J.S., A. Van Geen, D.C. McCorkle and J.M. Bernhard. 1999. Dissolved sulfide distributions in the water column and sediment pore waters of the Santa Barbara Basin. *Geochimica Et Cosmochimica Acta* 63(15): 2199-2209.
- La Montagne, G., I. Leifer, S. Bergmann, L.C. Van De Werfhorst and P.A. Holden. 2004. Bacterial diversity in marine hydrocarbon-seep sediments. *Environmental Microbiology* 6(8):799-808.
- Lawrence, M.G., and P.J. Crutzen. 1999. Influence of NO_x emissions from ships on tropospheric photochemistry and climate. *Nature* 402: 167-170.
- Leifer, I., J.R. Boles, B.P. Luyendyk and J.F. Clark. 2004. Transient discharges from marine hydrocarbon seeps: spatial and temporal variability. *Environmental Geology* 46(8):1038-1052.
- Leifer, I., M. Kamerling, B.P. Luyendyk and D. Wilson. 2009a. Geologic control of natural marine seep hydrocarbon emissions, Coal Oil Point seep field, California. *Geo-Marine Letters*: submitted.
- Leifer, I., M. Kamerling, B.P. Luyendyk and D. Wilson. 2009b. (in press). Spatial and temporal variations in marine seep field emissions on diurnal to decadal time scales and decameter to kilometer length scales. *Geochemistry, Geophysics, Geosystems*.
- Li, M. and C. Garrett. 1998. The relationship between oil droplet size and upper ocean turbulence. *Marine Pollution Bulletin* 36(12):961-971.
- Lissner, A.L., G.L. Taghon, D.R. Diener, S.C. Schroetner and J.D. Dixon. 1991. Recolonization of deep-water hard-substrate communities-potential impact from oil and gas development. *Ecological Applications* 1(3):258-267.

- Love, M. and A. York. 2006. The relationships between fish assemblages and the amount of bottom horizontal beam exposed at California oil platforms: fish habitat preferences at man-made platforms and (by inference) at natural reefs. *Fishery Bulletin-NOAA* 104(4): 542.
- MacDonald, I.R., G.S. Boland, J.S. Baker, J.M. Brooks, M.C. Kennicutt and R.R. Bidigare. 1986. Gulf of Mexico hydrocarbon seep communities. *Marine Biology* 101(2):235-247.
- Manago, F. and B. Williamson. 1997. Proceedings: public workshop, decommissioning and removal of oil and gas facilities offshore California--Recent experiences and future deepwater challenges. Public workshop, decommissioning and removal of oil and gas facilities offshore California: recent experiences and future deepwater challenges. Santa Barbara, California: 269.
- Mearns, A.J. and M.D. Moore. 1976. Biological study of oil platforms Hilda and Hazel, Santa Barbara Channel, California., University of California, Scripps Institution of Oceanography, La Jolla, California.
- Meinhold, A.F. and L.D. Hamilton. 1992. "Radium concentration factors and their use in health and environmental risk assessment", 1992 International Produced Water Symposium, Plenum Press, New York, 293-302.
- Mulino, M.M. and M.F. Rayle. 1992. "Produced water radionuclides fate and effects", 1992 International Produced Water Symposium, Plenum Press, New York, 281-292.
- Murphy, T.M., R.D. Mccaffrey, K.A. Patton and D.W. Allard. 2003. The need to reduce marine shipping emissions: A Santa Barbara County case study. Santa Barbara Air Pollution Control District. 19.
- Muschenheim, D.K. and T.G. Milligan. 1996. Flocculation and accumulation of fine drilling waste particulates on the Scotian shelf (Canada). *Marine Pollution Bulletin* 32(10):740-745.
- Muschenheim, D.K., T.G. Milligan, and D.C. Gordon, Jr. 1995. New technology and suggested methodologies for monitoring particulate waste discharged from offshore oil and gas drilling platforms and their effects on the benthic boundary layer environment. *Canadian Technical Report of Fisheries and Aquatic Sciences*: 2049.
- National Research Council (NRC). 1983. *Drilling discharges in the marine environment*, Washington, DC: National Academy Press.
- Neff, J.M. 1987. Biological effects of drilling fluids, drill cuttings, and produced waters. Long-term environmental effects of offshore oil and gas development. D.F. Bosch and N.N. Rabelais, Elsevier Applied Science Publishers, London: 469-538.
- Neff, J.M. 2002. *Bioaccumulation in marine organisms: Effect of contaminants from oil well produced water*. Elsevier Ltd, Amsterdam. 452 pp.

- Neff, J.M. and J.W. Anderson. 1981. Response of marine animals to petroleum and specific petroleum hydrocarbons. New York: Halsted Press.
- Neff, J.M., T.S. Sauer, Jr., and N. Maciolek. 1992. Composition, fate, and effects of produced water discharges to nearshore Marine waters. 1992 International Produced Water Symposium. J.P. Ray and F.R. Engelhardt. San Diego, California, Plenum Press, New York. 46: 371-385.
- Osenberg, C.W., R.J. Schmitt, S.J. Holbrook and D. Canestro. 1992. Spatial scale of ecological effects associated with an open coast discharge of produced water. 1992 International Produced Water Symposium. J.P. Ray and F.R. Engelhardt. San Diego, California, Plenum Press, New York. 46: 387-402.
- Page, H.M., J.E. Dugan, D.M. Schroeder, M.M. Nishimoto, M.S. Love and J.C. Hoesterey. 2007. Trophic links and condition of a temperate reef fish: comparisons among offshore oil platform and natural reef habitats. *Marine Ecology Progress Series* 344:245-256.
- Panzer, D. 1999. Monitoring wastewater discharges from offshore oil and gas facilities in the Santa Barbara Channel and Santa Maria Basin. Fifth California Islands Symposium. Santa Barbara, California.
- Parr, T.D., R.D. Tait, C.L. Maxon, F.C. Newton and J.L. Hardin. 2007. A descriptive account of benthic macrofauna and sediment from an area of planned petroleum exploration in the southern Caspian Sea. *Estuarine, Coastal and Shelf Science* 71(1-2):170-180.
- Phillips, C.R., M.H. Salazar, S.M. Salazar and B.J. Snyder. 2006. Contaminant exposures at the 4H shell mounds in the Santa Barbara Channel. *Marine Pollution Bulletin* 52(12):1668-1681.
- Pillai, M.C., J.D. Baldwin, and G.N. Cherr. 1990. Role of cytoskeleton in germtube elongation and nuclear translocation in a marine algal gametophyte. *Journal of Cell Biology* 111(5, Pt 2): 415a.
- Prasthofer, P. 1997. Offshore Production Facilities: Decommissioning of Topside Production Equipment. Proceedings: Public Workshop, Decommissioning and Removal of Oil and Gas Facilities Offshore California: Recent Experiences and Future Deepwater Challenges. F. Manago and B. Williamson. Santa Barbara, CA, Coastal Research Center, Marine Science Institute, University of California. OCS Study MMS 98-0023.
- Quigley, D.C., J.S. Hornafius, B.P. Luyenkyk, R.D. Francis, J. Clark and L. Washburn. 1999. Decrease in natural marine hydrocarbon seepage near Coal Oil Point, California, associated with offshore oil production. *Geology* 27(11):1047-1050.
- Rabelais, N.N., B.A. McKee, D.J. Reed and J.C. Means. 1992. Fate and effects of produced water discharges in coastal Louisiana, Gulf of Mexico, USA. 1992 International Produced Water Symposium. J.P. Ray and F.R. Engelhardt. San Diego, California, Plenum Press, New York. 46: 355-369.

- Raimondi, P.T., A.M. Barnett, and P.R. Krause. 1997. The effects of drilling muds on marine invertebrate larvae and adults. *Environmental Toxicology and Chemistry* 16(6):1218-1228.
- Raimondi, P.T. and R.J. Schmitt. 1992. Effects of produced water on settlement of larvae: field tests using red abalone. 1992 International Produced Water Symposium. J.P. Ray and F.R. Engelhardt. San Diego, California, Plenum Press, New York. 46: 415-430.
- Ray, J.P. and R.F. Englehardt. 1992. Produced water: technological/environmental issues and solutions. 1992 International Produced Water symposium. J.P. Ray and R.F. Englehardt. Catamaran Hotel, San Diego, California, Plenum Press, New York: 616.
- Rayle, M.F. and M.M. Mulino. 1992. Produced water impacts in Louisiana coastal waters, 1992 International Produced Water Symposium, Plenum Press, New York, 343-354.
- Reed, D.C., R.J. Lewis, and M. Anghera. 1994. Effects of an open-coast oil-production outfall on patterns of giant kelp (*Macrocystis pyrifera*) recruitment. *Marine Biology* 120(1):25-31.
- Reed, M. and S. Johnsen. 1996. Produced Water 2: Environmental Issues and Mitigation Technologies. 1995 International Produced Water Seminar, Trondheim, Norway. New York: Plenum Press.
- Reid, D.F. 1983. Radium in formation waters: How much and is it of concern? Fourth Annual Gulf of Mexico Information Transfer Meeting. New Orleans, LA, U.S. Dept. of the Interior, Minerals Management Service, Gulf of Mexico OCS Regional Office, New Orleans, Louisiana. OCS Report/MMS 84-0026.
- Reish, D.J. 1980. Marine biological characteristics of Platform Holly, and Santa Barbara County, California, Atlantis Scientific, Beverly Hills, California: 100 pp.
- Roy, Luke A., Scott Steinert, Steve M. Bay, Darrin Greenstein, Yelena Sapozhnikova, Ola Bawardi, Ira Leifer and Daniel Schlenk. 2003. Biochemical effects of petroleum exposure in hornyhead turbot (*Pleuronichthys verticalis*) exposed to a gradient of sediments collected from a natural petroleum seep in CA, USA. *Aquatic Toxicology* 65 (2): 159-169.
- Santa Barbara County Air Pollution Control District. 1994. The 1994 Clean Air Plan. Santa Barbara, California: Appendix D, Table 3.2.
- Schiff, K., J. Brown, D. Diehl and D. Greenstein. 2007. Extent and magnitude of copper contamination in marinas of the San Diego region, California, USA. *Marine Pollution Bulletin* 54(3):322-328.
- Schiff, K., D. Diehl, and A. Valkirs. 2004. Copper emissions from antifouling paint on recreational vessels. *Marine Pollution Bulletin* 48(3-4):371-377.
- Schiff, K.C., D.J. Reish, J.W. Andersen and S.M. Bay. 1992. A comparative evaluation of produced water toxicity. Produced water: ecological/environmental issues and solutions. J.P. Ray and F.R. Engelhardt. San Diego, California, Plenum Press, New York. 46: 199-207.

- Schroeder, D. and M. Love. 2004. Ecological and political issues surrounding decommissioning of offshore oil facilities in the Southern California Bight. *Ocean and Coastal Management* 47(1-2):21-48.
- Sorensen, H.C., Lars Kjeld Hansen, et al. 2002. Experience with and strategies for public involvement in offshore wind projects. *International Journal of Environment and Sustainable Development* 1(4):327.
- Spaulding, M.L., M. MacKinnon III, et al. 1999. *Spills of nonfloating oils: risk and response*. Washinton, DC: National Academy Press.
- Spies, Robert B. and Paul H. Davis. 1982. Toxicity of Santa Barbara seep oil to starfish embryos: Part 3--influence of parental exposure and the effects of other crude oils. *Marine Environmental Research* 6 (1): 3-11.
- Steinberger, A., E.D. Stein, et al. 2005. Offshore oil platform discharges to the pacific outer continental shelf along the coast of Southern California in 1996 and 2000. Annual report. Southern California Coastal Water Research Project.
- Steinhauer, M., E. Crecelius, and W. Steinhauer. 1994. Temporal and spatial changes in the concentrations of hydrocarbons and trace metals in the vicinity of an offshore oil-production platform. *Marine environmental research*. London 37(2): 129-163.
- Stephenson, M.T. 1992. A survey of produced water studies. 1992 International Produced Water Symposium. J.P. Ray and R.F. Englehardt. San Diego, California, Plenum Press: 1-11.
- Talley, W.K. 2003. Environmental Impacts of Shipping. *Handbook of Transport and the Environment*. D.A. Hensher and K.J. Button., Elsevier: 279-291.
- Thorpe, S.A. 1995. Vertical dispersion of oil droplets in strong winds; the Braer oil spill. *Marine Pollution Bulletin* 30(11):756-758.
- Tibbetts, P.J.C., I.T. Buchanan, L.J. Gawel and R. Large. 1992. Produced water: ecological/environmental issues and solutions. 1992 International Produced Water Symposium. J.P. Ray and R.F. Englehardt. San Diego, California, Plenum Press. 46: 97-112.
- U.S. Dept. of the Interior, Minerals Management Service (MMS). 2001. Delineation drilling activities in federal waters offshore Santa Barbara County, California. Draft Environmental Impact Statement. US Dept. of the Interior, Minerals Management Service, Pacific Outer Continental Shelf Region.
- United States Environmental Protection Agency (USEPA). 2000. General NPDES Permit. Number CAG 280000. U.S. EPA.

- Venkatesan, M.I., N. Chalaux, J.M. Bayona and E. Zeng. 1998. Butyltins in sediments from Santa Monica and San Pedro basins, California. *Environmental Pollution* 99(2):263-269.
- Vermaat, J.E., N.S.R. Agawin, M.D. Fortes, J.S. Uri, C.M. Duarte, N. Marba, S. Enriquea and W. Van Vierssen. 1997. The capacity of seagrasses to survive increased turbidity and siltation: The significance of growth form and light use. *Ambio* 26(8):499-504.
- Volpe, A.M. and B.K. Esser. 2002. Real-time ocean chemistry for improved biogeochemical observation in dynamic coastal environments. *Journal of Marine Systems* 36(1-2):51-74.
- Wagner, A. 1994. Effects of produced water from oil platforms on growth and survival of mysids, *Mysidopsis intii* and *Holmesimysis costata*. M.S. Thesis, Moss Landing Marine Laboratory, San Jose State University.
- Washburn, L., S. Stone, and S. Macintyre. 1999. Dispersion of produced water in a coastal environment and its biological implications. *Continental Shelf Research* 19(1):57-78.
- Wolfson, A., G.R. VanBlaricom, N. Davis and G.S. Lewbel. 1979. The Marine life of an offshore oil platform. *Marine Ecology Progress Series* 1(1):81-89.

18. PHYTOPLANKTON, ZOOPLANKTON, AND PELAGIC INVERTEBRATES

Plankton are not likely to be affected by most activities associated with installation, operation, or decommissioning and removal of structures. Phytoplankton, zooplankton, small pelagic invertebrates (e.g. hydrozoa) are likely to be mainly affected by changes in water quality and by entrainment in ballast or cooling water. Larger pelagic invertebrates may be more susceptible to these types of impacts due to delicate anatomy and smaller population sizes.

18.1 NOISE AND VIBRATION

It is generally assumed in filed Environmental Impact Statements that noise and vibrations will not cause adverse impacts to either phytoplankton or zooplankton communities. Similarly, pelagic invertebrates are not likely to be affected by noise and vibrations associated with installation and removal of structures. Impacts of vibrations could disturb aggregations of plankton in the water column, but this is likely to be much smaller and potentially undetectable due to larger movements of water producing similar, but more obvious, effects (i.e. wake and propeller wash).

18.2 INCREASED TURBIDITY

Increases in turbidity due to installation or removal of structures or drilling and cutting muds could temporarily affect local light availability. This could reduce the amount of productivity in the area surrounding the construction. However, this is not likely to cause more than a local, minor adverse impact on the plankton communities; because of short generation times and the large size of the populations found within the Southern California Bight, impacts to the community as a whole would be negligible.

Most pelagic invertebrates consume phytoplankton or zooplankton and are therefore not at a direct risk due to increased turbidity. In fact, gelatinous zooplankton (e.g. jellyfish) are often more tolerant of poor water quality conditions than other members of the secondary consumer trophic level (Purcell et al. 2007). Another source of change in light is artificial lighting of offshore platforms and support vessels during construction and operation, which is required by safety regulations. While gelatinous invertebrates are not likely to be affected by this light, squid are known to aggregate and often initiate mating to light cues (Hanlon et al. 2004). This change in lighting regimes could impact squid populations.

18.3 WASTEWATER

Similarly, the release of wastewater from platforms and service vessels could create localized pockets of increased nutrients and/or turbidity. This could impact the plankton community by locally increasing productivity due to nutrients or reducing productivity through light adsorption. Again, this productivity would be isolated and is unlikely to have an impact on the plankton communities of the Southern California Bight on the whole.

18.4 ENTRAINMENT

Entrainment and impingement of organisms is a major concern when utilizing seawater if the quantity of seawater used is large. Major sources of consumption include intake for platform operations and shipping operations, both cooling water and ballast water. Of these, ballast water is the largest component and impacts to the plankton communities will depend on the volume of ship traffic to any given location. Cargo vessels take on or release large quantities of ballast water when on- and offloading. This major consumption of water results in the entrainment of plankton, which are either killed or transported to a new location (USDOI, MMS 2007). The sizes of the phytoplankton and zooplankton populations of the Southern California Bight are large enough that even spills of the largest (top 95%) volumes would only have minor impacts to the community as a whole (French McCay et al. 2004).

Conversely, impacts to pelagic invertebrates have the potential to be more significant. Small pelagic invertebrates and the larval stages of medium and larger sized organisms can be entrained, removed from the environment with water for use, while medium-sized organisms would be impinged, trapped against a screen, at the intake. The entrainment of small invertebrates is not likely to have a major impact on their populations because they reproduce quickly and have large standing stocks. However, the entrainment of the larval stages of larger pelagic invertebrates has the potential to adversely impact the populations. Loss of young individuals can have impacts on future production of the population and food web. While the population of *Loligo opalescens*, the market squid, has been shown to rebound quickly from environmental changes (Reiss et al. 2004), any additional loss to the population could reduce the ability of this stock to recover.

18.5 INCREASED VESSEL TRAFFIC

Another impact of water usage and increased vessel traffic is the transportation of species between water bodies. The continued introduction of alien species is a major concern on the West Coast of the United States, with Los Angeles/Long Beach Harbor being one of the busiest ports in the country. While species transport between the OCS and the mainland is not a major concern, as most species are likely to be found in both locations, any vessel originating from other locations could potentially bring new invasive species to the area. Adverse impacts of invasive species include declining native populations and alterations in the food web (USDOI, MMS 2007).

18.6 CHEMICAL CONTAMINATION AND OIL SPILLS

The effect of even a large oil spill on the plankton community of the entire Southern California Bight is expected to be minor due to large population size and fast generation times. Reduced light can slow the production of phytoplankton temporarily, but this would be insignificant for populations as a whole. In addition to physical impairments due to coating in oil, plankton can also be affected by changing water quality conditions and toxic effects of hydrocarbons. The toxicity of oil to plankton, as well as to larger organisms, is largely due to exposure to and uptake of polyaromatic hydrocarbons (PAHs) (Anderson et al. 1974; Malins and Hodgins 1981; Neff and Anderson 1981), with the effects of the mixture of hydrocarbons being additive (McCarty et al. 1992; Swartz et al. 1995; DiToro et al. 2000; French-McCay 2002). Because accumulation of

toxic concentrations within tissues takes hours to days before lethal levels are reached, and a high level of turbulence is required to dissolve sufficient quantities of oil hydrocarbons into the water in order for concentrations to induce toxicity, only large spills of light crude oils and fuels would be expected to induce toxic effects on plankton (French-McCay 2002; French McCay et al. 2004). Those adverse impacts would be localized and temporary, as rapid dilution rates and fast generation times of plankton would reduce the impact of even the largest (top 95%) of spill volumes (French McCay et al. 2004; French-McCay et al. 2005).

In a study that looked at the lethal and sublethal affects of PAHs on copepods, Saiz et al. (2009) found reduced feeding and narcosis behaviors in copepods at much lower concentrations of PAHs than have been identified for mortality. This, coupled with reduced growth rates of prey items, has the potential to locally and temporarily impact the productivity of the food web. Zooplankton are an important link in the marine food web and provide much of resources for higher trophic levels, including commercially and ecologically important fish species. Thus, the reduction of zooplankton productivity or the contamination of this trophic level has the potential to cause adverse impacts at higher trophic levels, but again these would be temporary and localized.

The effects of oil spills on pelagic invertebrates have not been widely investigated. However, there is sufficient literature to indicate that all aquatic biota will suffer adverse effects from uptake of PAHs from oil, if exposure duration is long enough for accumulation in tissues to become toxic (French-McCay 2002). Those at the highest risk are neustonic organisms, or those that reside in the surface layer because impacts from an oil or gas spill would have prolonged effects on this shallow habitat. These neustonic assemblages are subject to surface contamination and ignoring their presence has led to underestimation of oil spill impacts in the past (Grant 1986). Gelatinous species are likely to be killed by contact with an oil slick and may be susceptible to toxicity through the consumption of contaminated prey. Many gelatinous species are planktonic in nature and therefore are more likely to be found in convergence zones (Zeidberg and Hammer 2002) where spilled oil collects thus increasing the probability of contact. However, gelatinous populations often experience fast growth and decline and therefore would not be majorly affected by an oil spill. Little research has been published on oil impacts to cephalopods, but their anatomy may put them at a high risk for effects of oiling, because of the large proportion of soft tissue. Behaviorally, contact with an oil slick should be low as most species utilize the entire water column.

Antifouling paints and coatings are used to keep organisms from growing on structures submerged in the water. While some parts of an oil platform will not be affected by the presence of attached organisms, the use of antifouling paint on other parts has the potential to impact the water quality by leaching chemicals, which can bioaccumulate in lower trophic organisms in the immediate vicinity. Most studies investigating this impact focus on marinas, where large surface areas covered in this paint can have a large impact on the environment. The large source and the protected nature of these areas create a scenario with high leaching rates and low flushing rates (Schiff et al. 2007). This is not likely to occur at offshore platforms, where leaching chemicals will be quickly diluted. An ecological risk assessment of leaching biocides found little risk in the coastal and offshore waters around Europe (Hall and Anderson 1999).

However, the effects of copper, a major component of biocide coatings used in the marine environment, on plankton communities can be important. Antifouling paints can leach between 3.7 and 4.3 $\mu\text{g}/\text{cm}^2/\text{day}$ depending on the type compared to rates of 0.24 $\mu\text{g}/\text{cm}^2/\text{day}$ for biocide-free varieties (Schiff et al. 2004). If allowed to leach into the environment, copper could have an impact on the plankton community composition. Research on nutrient limitations in coastal systems has shown that copper may play an important role in the uptake of iron and the production of diatoms (Peers et al. 2005; Cochlan et al. 2007). Artificial inputs of limited nutrients could alter the composition of communities within the phytoplankton community. This in turn could affect the zooplankton community if their food source is noticeably changed. While the likelihood of this occurring is small given the size of the Southern California Bight and the plankton populations, localized changes in community could be observed around platforms coated in copper-leaching paint.

18.7 SUMMARY AND DATA GAPS

Plankton, both phytoplankton and zooplankton, are not likely to be greatly impacted by the activities associated with oil and gas development. Localized effects around platforms and ships are possible where activities are concentrated. In the case of an oil spill, characteristics of these populations, including large size, high fecundity, and fast growth rates, will allow for quick recovery with few lasting effects.

Larger pelagic invertebrates are more susceptible to development activities and spills because they have slower growth rates and smaller populations, and may not continuously reproduce. Toxicity of oil and PAHs to this group has not been widely studied. This is an important data gap to fill as several of these species are commercially harvested.

18.8 LIST OF LITERATURE CITED—PHYTOPLANKTON

- Anderson, J.W., J.M. Neff, B.A. Cox, H.E. Tatem and G.M. Hightower. 1974. Characteristics of dispersions and water-soluble extracts of crude and refined oils and their toxicity to estuarine crustaceans and fish. *Marine Biology* 27:75-88.
- Cochlan, W.P., M.L. Wells, C.G. Trick and J. Herndon. 2007. The effect of iron and copper on nutrient utilization and new production in high-nitrate low-chlorophyll waters. *Geophysical Research Abstracts*. Vol. 9, 05126. European Geosciences Union.
- DiToro, D.M., J.A. McGrath and D.J. Hansen. 2000. Technical basis for narcotic chemicals and polycyclic aromatic hydrocarbon criteria. Water and tissue. *Environmental Toxicology and Chemistry* 19(8):1951-1970.
- French-McCay, D.P. 2002. Development and application of an oil toxicity and exposure model, OilToxEx. *Environmental Toxicology and Chemistry* 21:2080-2094.
- French McCay, D., N. Whittier, S. Sankaranarayanan, J. Jennings and D.S. Etkin. 2004. Estimation of potential impacts and natural resource damages of oil. *Journal of Hazardous Materials* 107(1-2):11-25.

- French-McCay, D.P., N. Whittier, C. Dalton, J.J. Rowe and S. Sankaranarayanan. 2005. Modeling fates and impacts of hypothetical oil spills in Delaware, Florida, Texas, California, and Alaska waters, varying response options including use of dispersants. In: Proceedings, International Oil Spill Conference, May 2005, Paper 399. Washington, DC: American Petroleum Institute.
- Grant, G.C. 1986. Zooneuston: Animals of the sea surface. In: Proceedings of the Workshop on the Sea-Surface Microlayer in Relation to Ocean Disposal December 18-19, 1985, Airlie, Virginia. EPA report 556/1-87/005. Pp. 45-62.
- Hall, L.W. and R.D. Anderson. 1999. A deterministic ecological risk assessment for copper in European saltwater environments. *Marine Pollution Bulletin* 38(3):207-218.
- Hanlon, R.T., N. Kangas and J.W. Forsythe. 2004. Egg-capsule deposition and how behavioral interactions influence spawning rate in the squid *Loligo opalescens* in Monterey Bay, California. *Marine Biology* 145:923-930.
- Malins, D.C. and H.O. Hodgins. 1981. Petroleum and marine fishes: A review of uptake, disposition, and effects. *Environmental Science and Technology* 15(11):1273-1280.
- McCarty, L.S., G.W. Ozburn, A.D. Smith and D.G. Dixon. 1992. Toxicokinetic modeling of mixtures of organic chemicals. *Environmental Toxicology and Chemistry* 11:1037-1047.
- Neff, J.M. and J.W. Anderson. 1981. Response of marine animals to petroleum and specific petroleum hydrocarbons. Applied Science Publishers, Ltd. London. 177 pp.
- Peers, G., S. Quesnel and N.M. Price. 2005. Cooper requirements for iron acquisition and growth of coastal and oceanic diatoms. *Limnology and Oceanography* 50(4):1149-1158.
- Purcell, J.E., S. Uye and W.-T. Lo. 2007. Anthropogenic causes of jellyfish blooms and their direct consequences for humans: A review. *Marine Ecology Progress Series* 350:153-174.
- Reiss, C.S., M.R. Maxwell, J.R. Hunter and A. Henry. 2004. Investigating environmental effects on population dynamics of *Loligo opalescens* in the Southern California Bight. Reports of the California Cooperative Oceanic Fisheries Investigations 45:87-97.
- Saiz, E., J. Movilla, L. Yebra, C. Barata and A. Calbet. 2009. Lethal and sublethal effects of naphthalene and 1,2-dimethylnaphthalene on naupliar and adult stages of the marine cyclopoid copepod *Oithona davisae*. *Environmental Pollution* 157:1219-1226.
- Schiff, K., J. Brown, D. Diehl and D. Greenstein. 2007. Extent and magnitude of copper contamination in marinas of the San Diego region, California, USA. *Marine Pollution Bulletin* 54:322-328.
- Schiff, K., D. Diehl and A. Valkirs. 2004. Copper emissions from antifouling paint on recreational vessels. *Marine Pollution Bulletin* 48: 371-377.

- Swartz, R.C., D.W. Schults, R.J. Ozretich, J.O. Lamberson, F.A. Cole, T.H. DeWitt, M.S. Redmond and S.P. Ferraro. 1995. Σ PAH: A model to predict the toxicity of polynuclear aromatic hydrocarbon mixtures in field-collected sediments. *Journal of Environmental Toxicology and Chemistry* 14(11):1977-1987.
- U.S. Dept. of the Interior, Minerals Management Service (MMS). 2007. Programmatic environmental impact statement for alternative energy development and production and alternate uses of facilities on the Outer Continental Shelf, Vol. I: Executive summary through chapter 4. U.S. Dept. of the Interior, Minerals Management Service. OCS EIS/EA MMS 2007-046.
- Zeidberg, L.D. and W.M. Hammer. 2002. Distribution of squid paralarvae, *Loligo opalescens* (*Cephalopoda: Myopsida*), in the Southern California Bight in the three years following the 1997-1998 El Niño. *Marine Biology* 141:111-122.

19. MACROPHYTES

Macrophyte habitats are vitally important to the ecosystems of the Southern California Bight. Many of the coastal wetlands have been modified or completely destroyed by human activity; thus, those that remain need to be preserved. The list of effects of oil and gas development is relatively short for this group of organisms; however, the risk still needs to be evaluated. Potential sources of effects are water quality changes, petroleum contamination, entanglement in equipment, and entrainment.

19.1 SEDIMENT DISPLACEMENT

Installation of offshore platforms includes pile driving, dredging, and pipeline laying, all of which result in degradation of water quality. The physical removal of plants is associated with the installation of most structures. The largest modifications of bottom habitats will be associated with the laying of pipeline. This can affect a large area and many habitats as pipelines connect the offshore structure to the onshore terminals. In offshore habitats, such as kelp forests, the effect is likely to be temporary as neighboring plants can recolonize after installation (USDOI, MMS 2001). However, in more sensitive areas, such as seagrass beds and intertidal marshes, effects may be greater and recovery could take longer if systems are already stressed by other factors (Zengel and Michel 1996). Associated with installation activities are localized and temporary decreases in water quality caused by suspension of sediments that could decrease light availability. This shading could result in reduced production; however, effects are likely to be temporary.

Removal of structures would result in disturbances similar to those discussed for installation. Localized and temporary decreases in water quality and clarity could have larger effects as structures may need to be removed with explosives. This could create plumes of sediment that could increase suspended sediment and decrease light availability.

19.2 INCREASED VESSEL TRAFFIC

Increased vessel traffic results in several sources of effects, including increased water consumption (entrainment, [see section 19.3](#)) and more mooring and anchor lines (entanglement, [see section 19.3](#)).

19.3 ENTRAINMENT AND ENTANGLEMENT

Increased water consumption could lead to higher entrainment rates of viable spores. While this impact is likely to be negligible, there could be localized effects of decreased reproduction or a reduction in genetic diversity. The presence of mooring and anchor lines could result in increased entanglement. This is of particular concern in kelp forests where *Macrocystis pyrifera* grows to the surface in long strands and could be ripped from the sediments. While this is a natural phenomenon that occurs during periods of increased storm activity (Graham 2002), any additional sources of removal could negatively affect the population. Adverse effects of a barge anchored in one location for several weeks were noted in a study of the kelp forest off Point Loma, San Diego; the authors believe the anchor cables and shading played a role in the poor health of the kelp in the immediate vicinity (Tegner et al. 1995).

19.4 DRILLING MUDS AND CUTTINGS

Activities associated with the operation of oil and gas platforms include the production of drilling cuttings and fluids, and produced water. Drilling cuttings and fluids are discharged as part of exploratory and developmental drilling. Cuttings are particles of crushed sedimentary rock that accumulate on the sediment around the drill site. Drilling fluids are mixtures of many materials suspended in water or an oil-based medium. While oil-based drilling fluids have never been permitted for discharge (NRC 2002), cuttings and water-based fluids could locally decrease water quality by increasing suspended sediment and pollutant concentrations, and reducing light availability. These effects are likely to be localized and temporary; however, any decrease in light at the ocean floor could result in noticeable production reductions due to the small amount of available light.

19.5 WASTEWATER

Produced water, a waste product of oil production, is also discharged into the surrounding environment. This fluid, which contains more salt than seawater and may also contain a multitude of contaminants, has been shown to negatively affect the fouling community on structures nearby (NRC 2002). The effect of produced water on the production of *M. pyrifera* zoospores and germination rates was shown to be variable within 50 m of the produced water outfall and negligible at farther distances (Reed and Lewis 1994; Reed et al. 1994). Additionally, experiments showed that arsenic, a component of produced water, has adverse effects on *M. pyrifera* gametophytes development (Cherr and Fan 1997). Pronounced effects are not likely to occur, as produced water will dilute into the environment and is discharged only at the platform.

19.6 CHEMICAL CONTAMINATION AND OIL SPILLS

Antifouling paints and coatings are used to keep organisms from growing on structures submerged in the water. While some parts of an oil platform will not be affected by the presence of attached organisms, the use of antifouling paint to eliminate encrusting growth on other parts has the potential to affect water quality. Additionally, lower trophic-level organisms in the immediate vicinity can bioaccumulate metals and organics from the paint, which can then impact those further up the food web. Most studies investigating this potential issue focus on marinas, where pollutants from large surface areas covered in antifouling paint can have a large impact on the environment. The large surface areas of the sources and the protected (enclosed) nature of these areas create a scenario with high leaching rates and low flushing rates (Schiff et al. 2007). This is not likely to occur at offshore platforms, where leaching chemicals will be quickly diluted.

Potential effects on macrophytes from oil released into the water will vary with the type of macrophyte and the type of oil. In a review of impacts to kelp forests Steneck et al. (2002) reported that oil spills induce only minimal adverse effects, compared with other factors including climate regimes, storm events, and fishing. A review of oil effects on marsh grasses outlines the pathways of injury and factors affecting degree of impact (Pezeshki et al. 2000).

Oil spilled on the water's surface would result in the oiling of *Macrocystis pyrifera*, giant kelp. This species grows taller than the depth of the water, resulting in floating leaves at the surface. Physical oiling of the plants would result in reduced photosynthesis and impaired respiration (Pezeshki et al. 2000). This could lead to reduced growth and potential senescence of the affected fronds or death of the entire plant. The trapping of oil at the surface could have indirect impacts on the understory by reducing the amount of available light. However, these communities are used to changes in light availability and have been shown to respond quickly when light returns (Clark et al. 2004; Reed et al. 2008). Physically oiled plants could also become detached from the substrate and form a drifting algal mat. This could have further impacts on the food web as these microhabitats are targeted by larger animals, including fish and sea turtles (Kingsford 1995).

Oil that reaches shore can produce lasting effects on macrophytes. Submerged seagrass beds are not likely to experience total mortality from a passing oil slick; only dissolved concentrations of oil hydrocarbons are assumed to affect production (French-McCay 2009). Conversely, emergent seagrasses and marsh grasses can trap oil in their leaves, allowing prolonged exposure to both the grasses and other organisms that utilize them as habitat or food. Physical oiling can affect emergent macrophytes in a couple of ways. Fouling of the leaves can result in reduced chlorophyll activity, due to blocking of sunlight, and impair respiration through the clogging of stomatal pores (Pezeshki et al. 2000). This effect may not result in lasting impacts, as plants can grow new leaves and recover relatively quickly. If oil penetrates and persists in the soil, prolonged effects to root growth can be found (reviewed in Pezeshki et al. 2000).

Recovery rates for different habitat types have been explored as part of remediation activities following spills. A review of current information can be found in French-McCay (2009). Three years is an average recovery time for the flora community of rocky shores and it has been shown that recovery rates for rocky shores slow following cleaning events (Ganning et al. 1984). If seagrasses are not killed, and only leaves are injured, recovery can be rapid. In Panama, seagrass beds had recovered within 7 months of the spill (Keller and Jackson 1991). In Southern California, Joy Zedler and colleagues at the Pacific Estuarine Research Laboratory (PERL) followed recovery of experimentally created saltmarsh. Zedler reported 60 percent recovery after 5 years with no significant additional recovery after (Joy Zedler, personal communication). The most important subtidal macroalgal bed habitat is the kelp forests of the Pacific Coast (*Macrocystis* spp.). This habitat is quick to recover biomass after both natural (e.g. storms, grazing; Graham 2002) and pollution (e.g., oil and sewer spills; Moody 1990; Tegner et al. 1995) events. Moody (1990) estimated that oiled kelp beds had 90 percent recovered in 3 to 4 years. However, after 14 years they had not fully recovered to pre-spill diversity.

19.7 SUMMARY AND DATA GAPS

Macrophytes are not likely to be affected by many of the activities associated with oil and gas development. High fecundity and fast growth rates allow these species to regenerate quickly after a disturbance, while the magnitude of disturbance due to oil and gas development is small, compared to the variation in these species due to natural disturbances. Localized positive and negative impacts are expected only in areas in the immediate vicinity of development.

Intertidal species can suffer the most serious effects when spilled oil reaches the shore. Oil cleanup and removal processes can have varying effects on these habitats. More research is needed to determine the best methods for removing oil that do not significantly harm or alter the recovery rates of these highly productive, and increasingly rare, habitats.

19.8 LIST OF LITERATURE CITED—MACROPHYTES

- Cherr, G.N. and T.W-M. Fan. 1997. Chronic toxicological effects of produced water on reproduction and development in marine organisms. MMS OCS Study 97-0024. Coastal Research Center, Marine Science Institute, University of California, Santa Barbara, California. MMS Cooperative Agreement Number 14-35-0001-30471. 71 pp.
- Clark, R.P., M.S. Edwards, and M.S. Foster. 2004. Effect of shade from multiple kelp canopies on an understory algal assemblage. *Marine Ecology Progress Series* 267:107-119.
- French-McCay, D. 2009. State-of-the-art and research needs for oil spill impact assessment modeling. In: *Proceedings of the 32nd Arctic and Marine Oil Spill Program (AMOP) Technical Seminar on Environmental Contamination and Response*, Vancouver, BC, Canada. Emergencies Science Division, Environment Canada, Ottawa, ON, Canada: in press.
- Ganning, B., D.J. Reisch and D. Straughan. 1984. Recovery and restoration of rocky shores, sandy beaches, tidal flats, and shallow subtidal bottom impacted by oil spills. In: Cairns, Jr., J., and A.L. Buikema, Jr., eds. *Restoration of habitats impacted by oil spills*. Boston, MA: Butterworth Publishers. Pp. 7-36.
- Graham, M. 2002. Prolonged reproductive consequences of short-term biomass loss in seaweeds. *Marine Biology* 140:901-911.
- Keller, B.D. and J.B.C. Jackson, eds. 1991. Long-term assessment of the oil spill at Bahia Las Minas, Panama, interim report, volume I: Executive summary. U.S. Dept. of the Interior, Minerals Management Service, Gulf of Mexico OCS Regional Office, New Orleans, LA. OCS Study MMS 90-0031.
- Kingsford, M.J. 1995. Drift algae: A contribution to near-shore habitat complexity in the pelagic environment and an attractant for fish. *Marine Ecology Progress Series* 116:297-301.
- Moody, A. 1990. A review of oil effects on marine plants, report to Environmental Canada #91 05066, Environmental Protection, River Road Environmental Technology Centre, Ottawa, CA, 1990. 30 pp.
- NRC. 2002. *Oil in the sea III: Inputs, fates and effects*. Washington, DC: National Academy Press. 446 pp.
- Pezeshki, S.R., M.W. Hester, Q. Lin, and J.A. Nyman. 2000. The effects of oil spill and clean-up on dominant U.S. Gulf Coast marsh macrophytes: A review. *Environmental Pollution* 108:129-139.

- Reed, D.C. and R.J. Lewis. 1994. Effects of an oil and gas-production effluent on the colonization potential of giant kelp (*Macrocystis pyrifera*) zoospores. *Marine Biology* 119:277-283.
- Reed, D.C., R.J. Lewis and M. Anghera. 1994. Effects of an open-coast oil-production outfall on patterns of giant kelp (*Macrocystis pyrifera*) recruitment. *Marine Biology* 120(1):25-31.
- Reed, D.C., A. Rassweiler and K. Arkema. 2008. Biomass rather than growth rate determines variation in net primary production by giant kelp. *Ecology* 89(9):2493-2505.
- Schiff, K., J. Brown, D. Diehl and D. Greenstein. 2007. Extent and magnitude of copper contamination in marinas of the San Diego region, California, USA. *Marine Pollution Bulletin* 54:322-328.
- Steneck, R.S., M.H. Graham, B.J. Bourque, D. Corbett, J.M. Erlandson, J.A. Estes and M.J. Tegner. 2002. Kelp forest ecosystems: Biodiversity, stability, resilience and future. *Environmental Conservation* 29(4):436-459.
- Tegner, M.J., P.K. Dayton, P.B. Edwards, K.L. Riser, D.B. Chadwick, T.A. Dean and L. Deysher. 1995. Effects of a large sewage spill on a kelp forest community: Catastrophe or disturbance? *Marine Environmental Research* 40(2):181-224.
- U.S. Dept. of the Interior, Minerals Management Service (MMS). 2001. Delineation drilling activities in federal waters offshore Santa Barbara County, California, draft environmental impact statement. U.S. Dept. of the Interior, Minerals Management Service, Pacific OCS Region, Camarillo, CA. MMS OCS EIS/EA 2001-046.
- Zengel, S.A. and J. Michel. 1996. Vegetation cutting as a clean-up method for salt and brackish marshes impacted by oil spills: A review and case history of the effects on plant recovery. *Marine Pollution Bulletin* 32(12):876-885.

20. BENTHOS

Benthic habitats and associated benthic invertebrates are important to the ecosystems of the Southern California Bight. These benthic resources are likely to be affected by bottom disturbance, changes in water quality, habitat alterations, and contamination by pollutants. Anthropogenic threats to deep sea soft-sediment environments include disposal of wastes, deep-sea fishing, oil and gas extraction, marine mineral extraction, pipeline and cable burial, and climate change (Glover and Smith 2003).

Installation of offshore platforms includes pile driving, dredging (including trenching), and pipeline laying. These construction activities result in physical habitat disturbance and alteration, degradation of water quality, and increased vessel traffic. Pile driving and installation creates vibrations (and noise), suspends sediments, and physically alters substrates by displacing the existing sediments and replacing them with high-vertical-relief hard substrate (Michel et al. 2007). Dredging physically removes existing substrate and infaunal organisms, creates suspended sediment plumes, and potentially leaves the seabed in an altered state. The largest modifications of benthic habitats will be associated with the laying of pipeline. This has the potential to affect a large area and number of habitats as pipelines connect the offshore structures to the onshore terminals. In general, benthic habitats consisting of long-lived, slow-growing, mostly epifaunal benthos are more sensitive to these effects than are habitats supporting fast-growing short-lived, mostly infaunal species.

Operational impacts on the benthos may result from fuel leaks and spills; discharge of drill cuttings, fluids, and produced water; habitat alteration due to increased structure on the seabed; and the leaching of chemicals from the installed structures (paints, antifouling agents). Impacts of accidental fuel leaks on benthic habitats are discussed in [Section 20.7](#).

Removal of offshore platforms and pipelines involves many of the same procedures as does installation. Impacts of decommissioning activities are assumed to be similar to those of construction, including effects from increased vessel traffic, sediment displacement, and suspended sediments. During decommissioning, the structures and decks above the surface are taken apart and shuttled to disposal sites via barges. The platform legs, wellheads, flare piles, conductors, submerged wells, caissons, and all other submerged structures then need to be removed to at least 5 m below the sea floor. In many cases this requires explosive removal. There are several common explosive removal techniques including bulk explosive charges, configured bulk charges, and cutting charges (Viada et al. 2008).

20.1 HABITAT ALTERATION

The installation of structures will result in the direct physical removal and disturbance of benthic habitat. As a result, all infaunal and sessile epifaunal organisms found in these substrates are lost via removal or crushing (USDOJ, MMS 2007a). Additionally, the majority of the motile benthic organisms are likely lost, but some larger organisms may be able to migrate out of the footprint. Jet plowing, trenching, and dredging associated with pipeline installation activities can leave the benthic habitat altered, ultimately changing the biological composition (Newell et al. 2004). Pre-disturbance conditions may not ever be reestablished, even if pipeline trenches or platform areas

are returned to similar physical makeup. Ecological and services functions within disturbed sediments could be altered for many years depending upon the amount of disturbance, the sizes of affected areas, and the types of communities present (USDOJ, MMS 2007b). In offshore soft-sediment habitats, the effects of physical alteration are likely to be temporary as neighboring infaunal invertebrates can recolonize after installation. However, in more sensitive areas, such as rocky reefs containing slow-growing epifaunal organisms, effects may be greater and recovery could take longer (see [Section 20.8](#) for more information on recovery rates). Shifts in benthic invertebrate assemblage could also affect demersal fish species that utilize the habitat for foraging.

During the operational phase, the added structure resulting from installed platforms promotes the establishment of artificial reef habitat. This habitat alteration has been observed and is well documented at several previously installed offshore structures in the Southern Study Area (USDOJ, MMS 2005). Platforms provide hard-bottom habitat that fosters growth of algae and sessile epifaunal invertebrates such as bryozoans, sponges, hydroids, barnacles, oysters, and mussels (Page and Dugan 1997). Organisms that attach and grow on the piles and platform supports provide habitat and food for many mobile invertebrates and fish. In addition to fouling organisms attached to the platform, benthic and pelagic species abundance below and surrounding the structure can be augmented. For example large mussel mounds are found on the benthic substrates around many platforms in Southern California (Helvey 2002). Richness and diversity of benthos tend to decrease with distance from the structure. Studies carried out at artificial reefs established on oil and gas platforms have shown that fish are attracted to such structures (Gunter and Geyer 1955; Sonnier et al. 1976; George and Thomas 1979; Gallaway and Lewbel 1982; Love and Westphal 1990; Love et al. 1993). The attraction of biota to artificial reefs, and their longevity at particular structures, varies depending upon the ecological role of the species in question, as well as environmental conditions. Several positive ecological and commercial impacts have been associated with artificial reef habitat, including increased biodiversity and fisheries. These platforms create small, localized, diverse ecosystems when built on shelf areas consisting of mostly low-relief, homogenous, soft-bottom habitat. Propagation of nonnative and invasive species is a potential negative impact of artificial reefs along the coast (Boehlert et al. 2008). Increased amount of structure, and decreased distance between platforms, may perpetuate a higher rate of island hopping of organisms.

During decommissioning, epifaunal and infaunal benthic organisms and habitat will be lost in the vicinity of any activity that removes or disturbs the sediments. In addition, removal of platform structure will result in removal and displacement of artificial reef habitat and all associated organisms.

20.2 SUSPENDED SEDIMENT AND SEDIMENTATION

Increased turbidity may result from construction activities; the degree of impact depends on concentration, sediment type (grain size), and length of exposure. Localized and temporary decreases in water quality caused by suspension of sediments occur but are not likely to have major adverse impacts on benthic biota. Temporary decreases in photosynthesis due to decreased light penetration may locally reduce primary productivity, which serves as a base of some benthic food webs. Benthic suspension feeders may be affected by increased

concentrations of suspended sediments, while the deposition of suspended sediments may adversely affect benthic organisms, including settled larvae, via burial or smothering (USDOJ, MMS 2007a). Burial and smothering is also a concern for sessile benthic organisms if sedimentation rates are high; motile organisms are not expected to be affected by burial. Increased suspended sediments resulting from increased vessel traffic and drilling activities are discussed in Sections 20.3 and 20.4.

20.3 INCREASED VESSEL TRAFFIC AND WATER USAGE

Increased vessel traffic to and from installations may result in additional mooring and anchoring events during construction. Semipermanent moorings placed on the sea floor initially crush benthic organisms and alter benthic substrates. These structures offer vertical relief and can attract epifaunal, encrusting, and reef organisms, which may vary from the adjacent habitat. Degree of species and habitat alteration depends on duration of mooring deployment. Seabed disturbance from anchoring, anchor dragging, and sweeping of the anchor chain can result in crushing and removal of infaunal and epifaunal benthic species (Lissner et al. 1991) in addition to temporarily suspending sediments.

Increased vessel traffic can also transport species between water bodies. The continued introduction of alien species is a major concern on the West Coast of the United States, with Los Angeles/Long Beach Harbor being one of the busiest ports in the country. While species transport between the OCS and the mainland is not a major concern, as most species are likely to be found in both locations, vessels originating from other locations could potentially bring new invasive species to the area. Adverse impacts of invasive species include declining native populations and alterations in the food web (USDOJ, MMS 2007b).

Increased vessel traffic and platform cooling water intakes will result in increased seawater usage during all phases of the project. This affects benthic organisms since most species have pelagic early life stages, such as eggs and larvae, that are a component of the zooplankton assemblage. Thus, entrainment and impingement of organisms via cooling and ballast water intake is a concern. ([See Chapter 18 for a related discussion with respect to impacts on plankton.](#))

20.4 DRILLING MUDS AND CUTTINGS

Drilling cuttings and fluids (muds) are discharged as part of exploratory and developmental drilling. Cuttings are particles of crushed sedimentary rock that accumulate on the sediment around the drill site. Cuttings can alter the physical state of the seabed; this may lead to shifts in biological composition (SAIC and MEC 1995). Drilling fluids are mixtures of many materials suspended in water or an oil-based medium. While oil-based drilling fluids have never been permitted for discharge (NRC 2003), water-based fluids could locally decrease water quality by increasing suspended sediment and pollutant concentrations. In a study of offshore platforms around Point Conception, deposition rates were found to vary with physical factors mainly currents (Battelle 1991). This resulted in transport of drilling-derived sediments and contaminants beyond the far-field distance (greater than 1 km; Battelle 1991).

A 4-year study conducted by Hyland et al. (1994) investigated impacts of drilling mud deposition off Point Arguello, California. Increased levels of barium were found in the surface sediments and suspended particles; however, concentrations were below toxic thresholds. Therefore, observed modification of the benthos was attributed to physical mechanisms via particle loading, such as decreased feeding and respiration. Hard-bottom taxa in adjacent areas showed reduced abundance in comparison to predrilling conditions due to deposition (Hyland et al. 1994). In another study, Raimondi et al. (1997) demonstrated that drilling muds from an active platform off Southern California affected settlement of red abalone (*Haliotis rufescens*) larvae as well as survivorship and viability of adult cup coral (*Paracyathus stearnsii*). High suspended sediments in the water can also cause behavioral changes in suspension feeders which retract their feeding appendages during time of high sediment concentrations (Battelle 1991). For a complete review of impacts as a result of drilling cutting and fluids please see the reports for the California OCS Monitoring Program: Assessment of Long-Term Changes in Biological Communities: Phase I (SAIC 1986), Phase II (Battelle 1991), and Phase III (SAIC and MEC 1995).

20.5 WASTEWATER

Produced water, a waste product of oil production, is also discharged into the surrounding environment. This fluid, which contains more salt than seawater, may also contain a multitude of contaminants. Oil and gas reservoirs have a natural water layer that lies under the hydrocarbons. During extraction, additional water is injected into the reservoirs to force oil to the surface. At the surface, the water is separated from the hydrocarbons by treatment with various chemicals, and then discharged into the sea. It has been shown that produced water can negatively affect the fouling community (epifaunal organisms attached to hard substrate) on nearby structures (NRC 2003). Reduced growth or accumulation of contaminants in the fouling community is anticipated only in close proximity to the discharge. Reproductive capability, embryonic development, and settling of pelagic stages of some epifaunal invertebrates, including sea urchins and mussels, may be affected depending on the degree of exposure (Cherr et al. 1993; Cherr and Fan 1997). These effects are likely to be localized and temporary.

20.6 NOISE AND VIBRATION

For all stages of the project, noise and vibrations are not known to cause adverse impacts to benthic communities. Although some motile invertebrates may move away from noise and vibration sources like pile driving during construction, these effects would be temporary (USDOI, MMS 2007b).

20.7 CHEMICAL CONTAMINATION AND OIL SPILLS

Antifouling paints and coatings are used to keep organisms from growing on structures submerged in the water. While some parts of an oil platform will not be affected by the presence of attached organisms, the use of antifouling paint on other parts has the potential to affect water quality and result in the bioaccumulation of metals and organics in lower-trophic-level organisms. Most studies investigating this potential issue focus on marinas (Schiff et al. 2007), where pollutants from large surface areas covered in antifouling paint can have a measurable impact on the environment. The large surface areas of the sources, and the protected (enclosed)

nature of marina areas, create situations with high leaching rates and low flushing rates (Schiff et al. 2007). This is not likely to occur at offshore platforms, where leaching chemicals will be quickly diluted. Thus, there is little chance the benthic organisms living around these structures will be impacted by leaching chemicals.

Spills associated with offshore gas and oil development result mainly from vessel releases, platform blowouts, and pipeline breaks. Currently there are several offshore oil operations conducted from platforms in Federal waters off the coast of California. To date, the largest oil spill from offshore oil operations in California was the 1969 80,000-barrel Santa Barbara spill (McCrary et al. 2003). Only a few small spills have occurred since 1969. In recent years there have been spills affecting marine resources from onshore operations at Avila (in 1992) and Guadalupe (in 1994), but data with respect to impacts remains confidential. However, the projections of oil production and exploration in the next few decades indicate continued risk of spill events (McCrary 2003). Engle et al. (1997) point out that pristine rocky shores of San Luis Obispo County are very vulnerable to oil spills, onshore pipeline breaks, future exploration leases, and other oil and gas operations. In addition, the shorelines of offshore islands are relatively unaffected by man's activities and are highly sensitive to oil impacts. The impacts and effects of spilled oil on benthos and associated benthic habitats depend on habitat and oil type.

Oil spilled on the ocean's surface starts to weather immediately, such that the most toxic components are lost to the atmosphere over hours to days after release. The rate of weathering is dependent on several factors, including the characteristics of the released oil and oceanographic conditions (French-McCay 2004). A variety of physical and chemical processes act to disperse and degrade the oil once it enters the ocean. These include spreading, evaporation of the more volatile constituents, dissolution into the water column, emulsification, entrainment of small droplets, agglomeration sinking, and photochemical modification. Subsurface release of oil may result in dispersion in the water column, eventually leading to coalescence of slicks at the surface (NRC 2003).

Some oils with a specific gravity greater than 1.0 may be neutrally buoyant or may sink when spilled (NRC 1999). These oils include some heavy fuels, asphalt products, and very heavy crude. Sinking of oil is dependent on physical conditions such as salinity and turbulence. Oils that sink pose risks to resources not usually affected by surface spills, such as shelf and deeper benthic habitats with soft sediments or rocky reefs (NRC 1999). Sunken oil may also cause episodic reoiling of shorelines depending on physical conditions (NRC 1999). Occurrence of sinking oil is rare and the impacts on benthic habitats are not well documented or known. More commonly, oil transport to the benthos occurs when oil adheres to suspended sediments and subsequently the combined mass sinks (NRC 1999; NRC 2003). This process and pathway is important when suspended sediments exceed about 100 mg/L (NRC 2003), which is not typical in the offshore waters of the Southern Study Area.

Oil can impact benthic organisms via three mechanisms: (1) direct contact with floating oil; (2) contact with entrained droplets; and (3) uptake of toxic dissolved components released in the water column. Direct contact of intertidal organisms with oil results in mortality via smothering (French-McCay 2009). Depending on turbulence from wind and wave action and other physical

conditions, oil can be entrained into the water column as droplets. Exposure to these microscopic entrained oil droplets may either mechanically impact benthic species (especially filter feeders) or act as a conduit for exposure to soluble and semi-soluble hydrocarbons (which may be taken up via the gills or digestive tract) (French-McCay 2009). The components of oil that cause most toxic effects on benthic organisms are the low-molecular-weight aromatic compounds, particularly the polynuclear aromatic hydrocarbons (i.e., the PAHs) (Neff et al. 1976; Rice et al. 1977; Malins and Hodgins 1981; Neff and Anderson 1981; Anderson 1985; McAuliffe 1987; French-McCay 2002; NRC 2003). Exposure to dissolved aromatics results in accumulation of toxins in tissues and disruption of cellular functions (French-McCay 2009). Uptake of less soluble PAHs has been related to many sublethal and chronic effects in benthic organisms (Neff et al. 1976; Malins and Hodgins 1981; Neff and Anderson 1981; NRC 2003).

Shoreline and intertidal habitats are the most vulnerable to the adverse impacts of oil spills. Shorelines act as sinks as oil sticks to, persists in, and smothers intertidal habitats. Hydrocarbon concentrations are elevated in sediments of oiled shorelines (Lee and Page 1997). Degree and severity of impact are dependent on substrate type, oil type, volume of oil deposited, and thickness of oil coating on habitats (French-McCay 2009). For a literature review on how these factors affect oiled shorelines see French-McCay (2009). Numerous reports document suppression of intertidal invertebrate densities on visibly oiled shorelines (Burns et al. 1993; Garrity and Levings 1993; Clarke and Ward 1994; Ansari and Ingole 2002; Yamamoto et al. 2003; Teruhisa et al. 2003; Andersen et al. 2008). Heavy oiling occurring in rocky intertidal resulted in decreased density of invertebrates and vegetation (Teruhisa et al. 2003; Yamamoto et al. 2003). If an oil slick settles into a protective embayment where seagrass and shallow habitats are found, reduction in dissolved oxygen and light, as well as toxic dissolved PAHs, can cause stress to primary producers and associated benthic organisms. This may cause a reduction in the diversity or population of epifauna and benthic infauna associated with these habitats (USDOJ, MMS 2007a, b).

Should oil affect shallow subtidal soft and rocky bottoms that are open to the ocean, oil may or may not persist over, or in, the habitat for very long. Exposure depends on physical conditions. Typically hydrocarbon concentrations in subtidal regions are orders of magnitude lower than that found in oiled shoreline sediments (Lee and Page 1997). However, shallow subtidal areas may be subjected to relatively high oil entrainment rates and aromatic hydrocarbon concentrations if high-energy mixing and turbidity occur near the coast. This can result in mortality of soft- and hard-bottom subtidal communities. For example, during the *North Cape* spill (Rhode Island, 1996), because of heavy surf conditions high concentrations of aromatic hydrocarbons took weeks to disperse (French-McCay 2003); millions of subtidal benthic organisms including lobsters and surf clams were killed.

Oil spills in the offshore environment will have less of an adverse impact on benthic habitats than will spills in shallow areas and near shorelines. Surface slicks occurring offshore can come into contact with benthic macrophytes that grow up to the surface, mainly kelp ([see Chapter 7](#)). In addition, the larval stages of several species of benthic invertebrates may come into contact with surface or entrained oil. Some invertebrate species have larval stages that are explicitly or partially neustonic (i.e., sea surface dwelling). In particular, crustacean larvae can be found in

the surface layer, including brachyuran crabs and spiny lobster (Young 1995; Reynolds and Sponaugle 1999; Acosta and Butler 1999). Direct contact of neuston with surface oil and entrained oil droplets is hypothesized to result in high mortality (Grant 1986). Dissolved aromatic hydrocarbons can also impact pelagic larval stages of benthic invertebrates.

20.8 RECOVERY OF BENTHIC HABITATS

20.8.1 Oil Spills

Recovery rates for different habitat types have been explored as part of remediation activities following spills. A review of current information with respect to recovery after oiling can be found in French-McCay (2009). In general for intertidal invertebrates, French et al. (1996) estimated that time for natural recovery is 3 to 5 years. Several post-spill monitoring studies of rocky intertidal areas show that cleanup activities tend to increase recovery time (potentially up to 9 years) (Broman et al. 1983; Houghton et al. 1991; Rolan and Gallagher 1991). In some cases, where the structure-forming species actually stabilizes the habitat, it is conceivable that permanent modification of that habitat could result from an acute incident (USDOJ, MMS 2001). Rocky intertidal oiled areas left to recover naturally show improvement within 2 to 5 years (Sell et al. 1995). Sandy beaches and mudflats can take anywhere from 1 to 5 years to fully recover after a spill event (French-McCay 2009). Seagrass beds have been observed to recover within 7 months of a spill (Keller and Jackson 1991); however, longer recovery estimates (several years) are more typically made (French-McCay 2009). Recovery of benthic organisms and vegetation in oiled salt marsh habitat may take anywhere from 5 to 18 years (French-McCay 2009). Subtidal kelp forests of the Pacific Coast are quick to recover biomass after both natural (e.g. storms, grazing; Graham 2002) and pollution (e.g. oil and sewer spills; Moody 1990; Tegner et al. 1995) events. Moody (1990) estimated that vegetative biomass in oiled kelp beds had 90 percent recovered in 3 to 4 years. However, after 14 years these habitats had not fully recovered to pre-spill diversity.

20.8.2 Physical Disturbance

The recovery rate of disturbed benthic habitats can be correlated to substrate type. In general, soft sediments tend to recover faster than hard. It is assumed that physical disturbances on soft-bottom habitat cause only temporary changes in species abundance or composition. Soft bottom infauna tends to repopulate or recolonize relatively quickly. Changes caused by disturbance may be well within the natural variability of the resource. The successional stages of soft sediment benthos occur over relatively short time periods. The initial colonization community can peak in population density within 6 months of the disturbance (Newell et al. 1998). The transitional community will establish and last anywhere from 1 to 5 years. The final equilibrium community comprised of larger, long lived species can establish between 5 to 10 years post disturbance (Newell et al. 1998). Successional stage duration in soft sediment habitats is highly dependent on grain size and water velocity (Newell et al. 1998). Sandy areas exposed to high hydrodynamic energy are able to recover the quickest, as organisms living in these environments are well adapted to a dynamic environment, are generally short-lived, and are highly motile. Species in more stable soft-sediment habitats (finer sands and silty clays) may take slightly longer to recover than will those in sandier habitats, especially habitats that support epifaunal species such as sponges.

Because both nearshore and deep rocky habitats tend to support long-lived epifaunal communities (corals, sponges, etc.), recovery from disturbance in these areas requires a much longer time than does recovery in soft sediments. In rocky substrates, recolonization of invertebrates from physical disturbances (e.g. anchor scars) is thought to occur initially by short-range larval supply and growth of bordering species (Thompson et al. 1993). Eventually motile predator-scavengers like echinoderms and larvae of long-range dispersal organisms such as hydroids and asteroids also colonize.

Nairn et al. (2004) evaluated impacts from sand dredging operations in the Outer Continental Shelf and documented short-term loss and changes in the benthic community structure as a result of dredging. A review of impact and recovery studies indicates that communities of comparable total abundance and diversity recolonize sites dredged for sand within several years. Although these recolonized communities may be similar to pre-dredged sites in total abundance and species diversity, their taxonomic composition is often very different before and after dredging (Nairn et al. 2004).

Newell et al. (1998) conducted a review of the impact of and seabed recovery from dredging activities in coastal waters. They estimated that soft bottom consisting of silty clay and sand would recover in less than 1 year, gravel habitats would recover in 2-3 years, and rocky substrates would recover between 5 and 10 years.

20.9 SUMMARY AND DATA GAPS

The rocky intertidal shorelines of Southern California are some of the most ecologically valuable habitats on the West Coast. They are also very vulnerable to the impacts of oil and gas development in addition to other natural and human-induced stressors. Future research should include monitoring and measuring the response of rocky intertidal communities to additive effects of development, oil spills, climate change, and climate regime shifts.

Benthic recovery of disturbed habitats is an important area of research. Nairn et al. (2004) asks an important ecological question “Do the new benthic communities fill the same trophic function and provide the same energy transfer to higher trophic levels as did the original communities?” For this question to be answered, comprehensive information on pre- and post-disturbance processes must be documented. These data gaps should be the focus of future seabed recovery studies. If they do not, then the potential long-term and cumulative ecological impacts of disturbance may be far greater than predicted to date (Nairn et al. 2004).

20.10 LIST OF LITERATURE CITED—BENTHOS

- Acosta, C.A. and M.J. Butler, IV. 1999. Adaptive strategies that reduce predation on spiny lobster postlarvae during onshore transport. *Limnology and Oceanography* 44:494-501.
- Anderson, J.W. 1985. Toxicity of dispersed and undispersed Prudhoe Bay crude oil fractions to shrimp, fish, and their larvae. API Publ. 4441. Washington, DC: American Petroleum Institute. 52 pp.

- Andersen, L.E., F. Melville and D. Jolley. 2008. An assessment of an oil spill in Gladstone, Australia—Impacts on intertidal areas at one month post-spill. *Marine Pollution Bulletin* 57:607-615.
- Ansari, Z.A. and B. Ingole. 2002. Effect of an oil spill from M V Sea Transporter on intertidal meiofauna at Goa, India. *Marine Pollution Bulletin* 44:396-402.
- Battelle. 1991. California OCS phase II monitoring program. Final Report to the U.S. Dept. of the Interior, Minerals Management Service, Pacific OCS Region, Camarillo, CA. MMS OCS Study 91-0083.
- Boehlert, G.W., G.R. McMurray and C.E. Tortorici. 2008. Ecological effects of wave energy in the Pacific Northwest. U.S. Dept. of Commerce, NOAA Tech. Memorandum NMFS-F/SPO-92. 174 pp.
- Broman, D., B. Ganning and C. Lindblad. 1983. Effects of high pressure, hot water shore cleaning after oil spills on shore ecosystems in the northern Baltic proper. *Marine Environmental Research* 1:173-187.
- Burns, K.A., S.D. Garrity and S.C. Levings. 1993. How many years until mangrove ecosystems recover from catastrophic oil spills? *Marine Pollution Bulletin* 26:239-248.
- Cherr, G.N. and T.W.-N. Fan. 1997. Chronic toxicological effects of produced water on reproduction and development in marine organisms, Final technical report. U.S. Dept. of the Interior, Minerals Management Service, Pacific OCS Region, Camarillo, CA. MMS 97-0024. 9 pp.
- Cherr, G.N., R.M. Higashi and J.M. Shenker. 1993. Assessment of chronic toxicity of petroleum and produced water components to marine organisms, Final study report. U.S. Dept. of the Interior, Minerals Management Service, Pacific OCS Region, Camarillo, CA. MMS 94-0035. 130 pp.
- Clarke, P.J. and T. Ward. 1994. The response of southern hemisphere saltmarsh plants and gastropods to experimental contamination by petroleum hydrocarbons. *Journal of Experimental Marine Biology and Ecology* 175:43-57.
- Engle, D.L., R. Ambrose, P. Raimondi, S.N. Murray, M. Wilson and S. Sapper. 1997. Rocky intertidal resources in San Luis Obispo, Santa Barbara, and Orange Counties. U.S. Dept. of the Interior and Minerals Management Service, Pacific OCS Region, Camarillo, CA. MMS OCS Study 98-0011. 73 pp.
- French, D., M. Reed, K. Jayko, S. Feng, H. Rines, S. Pavignano, T. Isaji, S. Puckett, A. Keller, F.W. French, III, D. Gifford, J. McCue, G. Brown, E. MacDonald, J. Quirk, S. Natzke, R. Bishop, M. Welsh, M. Phillips and B.S. Ingram. 1996. Final Report, The CERCLA Type A Natural Resource Damage Assessment Model for Coastal and Marine Environments (NRDAM/CME), Technical Documentation, Vol. I-V. Submitted to the Office of

- Environmental Policy and Compliance, U.S. Dept. of the Interior, Washington, DC, Contract No. 14-0001-91-C-11.
- French-McCay, D.P. 2002. Development and application of an oil toxicity and exposure model, OilToxEx. *Environmental Toxicology and Chemistry* 21:2080-2094.
- French-McCay, D.P. 2003. Development and application of damage assessment modeling: example assessment for the North Cape Oil Spill. *Marine Pollution Bulletin* 47(9-12):341-359.
- French-McCay, D.P. 2004. Oil spill impact modeling: Development and validation. *Environmental Toxicology and Chemistry* 23(10):241-2456.
- French-McCay, D. 2009. State-of-the-art and research needs for oil spill impact assessment modeling. In: *Proceedings of the 32nd Arctic and Marine Oil Spill Program (AMOP) Technical Seminar on Environmental Contamination and Response*, Vancouver, BC, Canada. Emergencies Science Division, Environment Canada, Ottawa, ON, Canada: in press.
- Gallaway, B.J. and G.S. Lewbel. 1982. The Ecology of petroleum platforms in the northwestern Gulf of Mexico: A community profile. U.S. Dept. of the Interior, U.S. Fish and Wildlife Service, Office of Biological Services, Washington, DC. FWS/OBS-82/27.
- Garrity, S.D. and S.C. Levings. 1993. Effects of an oil spill on some organisms living on mangrove (*Rhizophora mangle* L.) roots in low wave-energy habitats in Caribbean Panama. *Marine Environmental Research* 35:251-271.
- George, R.Y. and P.J. Thomas. 1979. Biofouling community dynamics in Louisiana shelf oil platforms in the Gulf of Mexico. *Rice University Study* 65(4&5):553-574.
- Glover, A.G. and C.R. Smith. 2003. The deep seafloor ecosystem: current status and prospects for change by 2025. *Environmental Conservation*, 30(3): 1-23.
- Grant, G.C. 1986. Zooneuston: Animals of the sea surface. In: *Proceedings of the Workshop on the Sea-Surface Microlayer in Relation to Ocean Disposal*, Airlie, VA. EPA report 556/1-87/005. Pp. 45-62.
- Graham, M. 2002. Prolonged reproductive consequences of short-term biomass loss in seaweeds. *Marine Biology* 140:901-911.
- Gunter, G. and R.A. Geyer. 1955. Studies of fouling organisms of the northwest Gulf of Mexico. Published at the Institute of Marine Science, University of Texas 4(1): 37-87.
- Helvey, M. 2002. Are Southern California oil and gas platforms essential fish habitat? *ICES Journal of Marine Science* 59:S266-S271.

- Houghton, J.P., D.C. Lees, W. B. Driskell and A.J. Mearns. 1991. Impacts of the Exxon Valdez spill and subsequent cleanup on intertidal biota-1 year later. In: Proceedings of the 1991 Oil Spill Conference. Washington, DC: American Petroleum Institute. Pp. 467-475.
- Hyland, J., Hardin, D., Steinhauer, M., Coats, D., Green, R. and Neff, J. 1994. Environmental impact of offshore oil development on the Outer Continental Shelf and slope off Point Arguello, California. *Marine Environmental Research* 37(2):195-229.
- Keller, B.D. and J.B.C. Jackson. 1991. Long-term assessment of the oil spill at Bahia Las Minas, Panama, interim report, Volume I: Executive summary. U.S. Dept. of the Interior, Minerals Management Service, Gulf of Mexico OCS Regional Office, New Orleans, LA. OCS Study MMS 90-0030. 49 pp.
- Lee, R.F. and D.S. Page. 1997. Petroleum hydrocarbons and their effects in subtidal regions after major oil spills. *Marine Pollution Bulletin* 34(11):928-940.
- Lissner, A.L., G.L. Taghon, D.R. Diener, S.C. Schroeter and J.D. Dixon. 1991. Recolonization of deep water hard substrate communities—Potential impacts from oil and gas development. *Ecological Applications* 1(3):258-267.
- Love, M.S., J. Hyland, A. Ebeling, T. Herrlinger, A. Brooks and E. Imamura. 1993. A pilot study of the distribution and abundances of rockfishes in relation to natural environmental factors and an offshore oil and gas production platform off the coast of Southern California. In: Effects of OCS oil and gas production platforms on rocky reef fishes and fisheries. U.S. Dept. of the Interior, Minerals Management Service, Pacific OCS Region, Camarillo, CA. OCS Study MMS 92- 0021.
- Love, M.S. and W. Westphal. 1990. Comparison of fishes taken by a sportfishing party vessel around oil platforms and adjacent natural reefs near Santa Barbara, California. *Fishery Bulletin* 88(3):599-605.
- Malins, D.C. and H.O. Hodgins. 1981. Petroleum and marine fishes: A review of uptake, disposition, and effects. *Environmental Science & Technology* 15(11):1272-1280.
- McAuliffe, C.D. 1987. Organism exposure to volatile/soluble hydrocarbons from crude oil spills—A field and laboratory comparison. In: Proceedings of the 1987 International Oil Spill Conference. Washington, DC: American Petroleum Institute. Pp. 275-288.
- McCrary, M.D., D.E. Panzer and M.O. Pierson. 2003. Oil and gas operations offshore California: Status, risks, and safety. *Marine Ornithology* 31(1):43-49.
- Michel, J., H. Dunagan, C. Boring, E. Healy, W. Evans, J. Dean, A. McGillis and J. Hain. 2007. Worldwide synthesis and analysis of existing information regarding environmental effects of alternative energy uses on the Outer Continental Shelf. U.S. Dept. of the Interior and Minerals Management Service. MMS OCS Study 2007-38.

- Moody, A. 1990. A review of oil effects on marine plants, report to environmental Canada #91 05066. Environmental Protection, River Road Environmental Technology Centre, Ottawa, CA. 30 pp.
- Nairn, R., J.A. Johnson, D. Hardin, and J. Michel. 2004. A Biological and physical monitoring program to evaluate long-term impacts from sand dredging operations in the United States outer continental shelf. *Journal of Coastal Research* 20(1):126-137.
- National Research Council (NRC). 1999. Spills of nonfloating oils, risks and response. Washington, DC: National Academy Press. 75 pp.
- National Research Council (NRC). 2003. Oil in the sea III: Inputs, fates and effects. Washington, DC: National Academy Press. 446 pp.
- Neff, J.M and J.W. Anderson. 1981. Response of marine animals to petroleum and specific petroleum hydrocarbons, Applied Science Publishers Ltd., London. 177 pp.
- Neff, J.M., J.W. Anderson, B.A. Cox, R.B. Laughlin, Jr., S.S. Rossi, and H.E. Tatem. 1976. Effects of petroleum on survival respiration, and growth of marine animals. In: Sources, effects and sinks of hydrocarbons in the aquatic environment. Washington, DC: American Institute of Biological Sciences. Pp. 515-539.
- Newell, R.C., L.J. Seiderer and D.R. Hitchcock. 1998. The impact of dredging works in coastal waters: A review of the sensitivity to disturbance and subsequent recovery of biological resources on the seabed. *Oceanography and Marine Biology: An Annual Review* 36:127-178.
- Newell, R.C., L.J. Seiderer, N.M. Simpson, and J.E. Robinson. 2004. Impacts of marine aggregate dredging on benthic macrofauna off the southern coast of the United Kingdom. *Journal of Coastal Research* 20(1):115-125.
- Page, M. and J. Dugan. 1997. Effect of offshore oil platform structures on the distribution pattern of commercially important benthic crustaceans, with emphasis on the rock crab. In: Manago, F. and B. Williamson, eds. Proceedings: Public Workshop, Decommissioning and Removal of Oil and Gas Facilities Offshore California: Recent Experiences and Future Deepwater Challenges. Coastal Research Center, Marine Science Institute, University of California, Santa Barbara, CA. OCS Study MMS 98-0023.
- Raimondi, P.T., A.M. Barnett and P.R. Krause. 1997. The effects of drilling muds on marine invertebrate larvae and adults. *Environmental Toxicology and Chemistry* 16(6):1218-1228.
- Reyns, N. and S. Sponaugle. 1999. Patterns and processes of brachyuran crab settlement to Caribbean coral reefs. *Marine Ecology Progress Series* 185:155-170.
- Rice, S.D., J.W. Short and J.F. Karinen. 1977. Comparative oil toxicity and comparative animal sensitivity. In: Wolfe, D.A., ed. Fate and effects of petroleum hydrocarbons in marine ecosystems and organisms. New York: Pergamon Press. Pp. 78-94.

- Rolan, R.G. and R. Gallagher. 1991. Recovery of intertidal biotic communities at Sullom Voe following the Esso Bernicia oil spill of 1978. In: Proceedings of the 1991 International Oil Spill Conference. API Publ. 4529. Washington, DC: American Petroleum Institute. Pp. 461-465.
- Schiff, K., J. Brown, D. Diehl and D. Greenstein. 2007. Extent and magnitude of copper contamination in marinas of the San Diego region, California, USA. *Marine Pollution Bulletin* 54(3):322-328.
- Science Applications International Corporation (SAIC) and MEC Analytical Systems, Inc. (MEC). 1995. Monitoring assessment of long-term changes in biological communities in the Santa Maria Basin: Phase III, Final report. Report submitted to the U.S. Dept. of the Interior, Minerals Management Service/National Biological Service, under Contract No. 14-35-0001-30584. MMS OCS Study 95-0049.
- Science Applications International Corporation (SAIC). 1986. Assessment of long-term changes in biological communities in the Santa Maria Bais and western Santa Barbara Channel—Phase I. Volume 1-Executive Summary prepared for the U.S. Dept. of the Interior, Minerals Management Service, Pacific OCS Region, Los Angeles, CA. MMS OCS Study 86-0012.
- Sell, D., L. Conway, T. Clark, G.B. Picken, J.M. Baker, G.M. Dunnet, A.D. McIntyre and R.B. Clark. 1995. Scientific criteria to optimize oil spill clean up. In: Proceedings of the 1995 Oil Spill Conference. Washington, DC: American Petroleum Institute. Pp. 595-611.
- Sonnier, F., J. Teerling and H.D. Hoese. 1976. Observations on the offshore reef and platform fish fauna of Louisiana. *Copeia* 1976(1):105-111.
- Tegner, M.J., P.K. Dayton, P.B. Edwards, K.L. Riser, D.B. Chadwick, T.A. Dean and L. Deyscher. 1995. Effects of a large sewage spill on a kelp forest community: Catastrophe or disturbance? *Marine Environmental Research* 40(2):181-224.
- Teruhisa, T., M. Nakaoka, Kawai, H., and T. Yamamoto, Marine Life Research Group of Takeno and K. Ohwada. 2003. Impacts by heavy oil spill from Nakhodka on inter-tidal ecosystem in the Sea of Japan: An approach to impact evaluation with geographical information system. *Marine Pollution Bulletin* 47:99-104.
- Thompson, B., J. Dixon, S. Schroeter and D.J. Reish. 1993. Benthic invertebrates. In: Dailey, M.D., D.J. Reish, and J.W. Anderson, eds. *Ecology of the Southern California bight: A synthesis and interpretation*. Berkeley, CA: University of California Press. Pp. 369-458.
- U.S. Dept. of the Interior, Minerals Management Service (MMS). 2001. Deepwater program: Literature review, environmental risks of chemical products used in Gulf of Mexico deepwater oil and gas operations. Vols. 1 and 2. U.S. Dept. of the Interior, Minerals Management Service, Gulf of Mexico OCS Region, New Orleans, LA. OCS Study 2001-011 and 2001-012.

- U.S. Dept. of the Interior, Minerals Management Service (MMS). 2005. Survey of invertebrate and algal communities on offshore oil and gas platforms in Southern California. U.S. Dept. of the Interior, Minerals Management Service, Pacific OCS Region, Camarillo, CA. MMS 2005-070.
- U.S. Dept. of the Interior, Minerals Management Service (MMS). 2007a. Gulf of Mexico OCS oil and gas lease sales: 2007-2012; Western Planning Area Sales 204, 207, 210, 215, and 218; Central Planning Area Sales 205, 206, 208, 213, 216, and 222—final environmental impact statement. 2 vols. U.S. Dept. of the Interior, Minerals Management Service, Gulf of Mexico OCS Region, New Orleans, LA. OCS EIS/EA MMS 2007-018.
- U.S. Dept. of the Interior, Minerals Management Service (MMS). 2007b. Programmatic environmental impact statement for alternative energy development and production and alternate uses of facilities on the Outer Continental Shelf, Volume I: Executive summary through chapter 4. U.S. Dept. of the Interior, Minerals Management Service. OCS EIS/EA MMS 2007-046.
- Viada, S.T., R.M. Hammer, R. Racca, D. Hannay, M.J. Thompson, B.J. Balcom and N.W. Phillips. 2008. Review of potential impacts to sea turtles from underwater explosive removal of offshore structures. *Environmental Impact Assessment Review* 28:267-285.
- Yamamoto, T., M. Nakaoka, T. Komatsu and H. Kawai, Marine Life Research Group of Takeno, and K. Ohwada. 2003. Impacts by heavy-oil spill from the Russian tanker Nakhodka on intertidal ecosystems: Recovery of animal community. *Marine Pollution Bulletin* 47:91-98.
- Young, C.M. 1995. Behavior and locomotion during the dispersal phase of larval life. In: McEdward L., ed. *Ecology of Marine Invertebrate Larvae*. CRC Press. Pp. 249-277.

21. FISH

The fish assemblages found in the Southern Study Area are ecologically diverse and contain many commercially important populations. Fish and essential fish habitat (EFH) for these species are likely to be affected by bottom disturbance, increased noise and vibrations, changes in water quality, entrainment and impingement from water intake and discharge, habitat alterations, and contamination.

Installation of offshore platforms includes surveying, pile driving, dredging, and pipeline laying. These construction activities result in physical habitat disturbance and alteration, increased degradation of water quality, increased vessel traffic, increased noise and vibration, increased water usage, and additional discharges. Surveys conducted around potential development sites will result in higher vessel traffic and some benthic modification from seabed core collection. In addition, increased noise from sonar, core drilling, and seismic survey airguns may result from surveying activities. Pile driving creates suspended sediments, noise, and vibration. Installation of piles physically alters substrates by displacing the existing sediments of the seabed and replacing them with high vertical-relief hard substrate. Dredging physically removes existing sediments and potentially leaves the seabed in an altered state. Dredging also creates suspended sediment plumes and temporary periods of reduced water quality. Jetting, trenching, or dredging associated with pipeline installation results in temporary reduction in water quality due to increased suspended sediments.

During operations, impacts to fish populations may result from habitat alterations, drilling activities, produced water, seawater usage, and artificial lighting. Removal of offshore platforms and pipelines includes many of the same procedures as the installation, although pile driving is not expected. Impacts of decommissioning activities are assumed to be similar to that of construction. Fish resources and essential fish habitat could be affected by increased vessel traffic, sediment displacement, suspended sediments, noise generated during dismantling, and the alteration and loss of habitat provided by the existing structures.

21.1 HABITAT ALTERATION

Removal of sediment and seabed disturbance can affect fish populations via loss of physical habitat and loss of forage items (crushed or removed benthic invertebrates), and can therefore modify assemblages. Installation of platform supports may alter benthic habitat from low relief soft substrate to a hard, high vertical relief setting. This may result in habitat loss for benthic fish species such as flatfish and a shift in assemblage toward more structure-preferring species (Love et al. 2003). In dredged or trenched areas that are backfilled with substrate or left open and exposed (i.e. pipeline corridors), the benthic invertebrate forage base of many fish species may not recover to the pre-disturbance assemblage (Newell et al. 2004). Therefore, fish species assemblages in the immediate area of pipeline corridors may be affected. During construction, increased anchoring and mooring is expected. Benthic habitat alterations due to temporary mooring blocks in the sea floor may attract several fish and invertebrate species that are associated with increased structural complexity and hard substrate. Anchoring and anchor dragging can scar the sea floor and remove benthic forage species of many fish (Lissner et al.

1991). For more detail on impacts to the benthic habitat and benthic invertebrate assemblage refer to [section 20.1](#).

Following installation of platforms, during the operational phase, the added structure to the seabed will promote the establishment of artificial reef habitat. Fishes, including groundfish and pelagic species, would likely be attracted to the newly formed habitat complex. Fish population numbers in the immediate vicinity of the platforms are likely to be higher than those in surrounding waters. This habitat alteration has been observed and is well documented at several previously installed offshore structures in the Southern Study Area (USDOJ, MMS 2005). Platforms supply hard bottom habitat that fosters growth of algae and sessile epifaunal invertebrates. These biofouling organisms provide habitat and food for many motile invertebrates and fish. Piles of biofouling bivalve shells tend to accumulate on the sea floor around the base of the platform (Schroeder and Love 2004). These “shell mounds” provide areas of low to medium relief hard substrate. Several positive ecological and commercial impacts have been associated with artificial reef habitat including increased biodiversity and fisheries. Platforms and their surrounding habitat support ecological functions such as nursery, feeding, and spawning grounds (Helvey 2002; Love et al. 2003; Love et al. 2005). Effects on diversity and fish abundance would be project-specific since they would be largely dependent on the prevalence of various types of habitats and fish species within surrounding areas (USDOJ, MMS 2007).

Fishes using artificial reefs can generally be classified as either resident or transient (Love et al. 2000). Within the resident community, there are species directly dependent upon the biofouling community for food or cover, and species that appear attracted to the structures for cover but exhibit little trophic dependence on the biofouling community. Most of the large predators around petroleum platforms are believed to be highly transient (Love et al. 2000). Both pelagic prey and predator species are attracted to these structures.

Of the 82 groundfish species federally managed in the Southern California Bight, 40 of them have been observed at Southern California platforms (Love et al. 1994; Love et al. 2000). Some rare or overfished fish species attracted to such structures could be negatively affected if increased harvest were to result due to a concentration of fishing effort. Of particular interest, approximately 32 species of the rockfish family (*Sebastes* spp.) are associated with platforms (Helvey 2002). A tagging study done by Hartman (1987) found that most rockfish species were mostly localized around platforms, but did embark on small-scale movements to adjacent platforms.

During decommissioning, the structures and decks above the surface are taken apart and shuttled to disposal sites via barges. The platform legs, wellheads, flare piles, conductors, submerged wells, caissons, and all other submerged structures then need to be removed to at least five meters below the sea floor. In many cases this requires explosive removal. There are several common explosive removal techniques including bulk explosive charges, configured bulk charges, and cutting charges (Viada et al. 2008). Injurious effects are caused by primary blast injuries or cavitations and the effects of rarefaction waves (Viada et al. 2008). Vertebrates with gas-filled internal organs, such as swim bladders, are particularly vulnerable to explosions

(Govoni et al. 2008). Thus, some degree of mortality of adult and large juvenile fish is expected. Two major zones of injury exist from blasting (Schroeder and Love 2004). The first zone is roughly spherical and centered around the explosion. Fish and organisms in this zone experience almost total mortality. The second zone is in the shape of a shallow disk that is also centered around the explosion, but located near the surface of the water. Fishes in this zone experience mortality from rapid swimbladder expansion as the initial shock wave reflects off the surface of the water (Schroeder and Love 2004). Fishes without swimbladders may experience auditory damage or debilitating physiological stress (Schroeder and Love 2004). The impact of an explosion on any organism is dependent on its distance from it. Mortality as a function of distance in the blast zone is not well defined and is dependent on the force of the explosion (Schroeder and Love 2004). Total mortality can be predicted with some accuracy if abundance and distribution of fish is known (O'Keefe 1984). Govoni et al. (2008) found that larval fish are impacted by underwater explosions in the immediate area, but impacts are unlikely to affect fish at the population level. In addition contaminated sediments are likely to resuspend in the water column during removal of structures embedded in the sea floor (Schroeder and Love 2004).

Removal of platform structures will result in removal and displacement of artificial reef habitat and all associated organisms. Fish composition shifts toward soft-sediment assemblages (if shell mounds are removed) or to an assemblage similar to a low relief cobble (if shell mounds are not removed) would result from total rig removal (Schroeder and Love 2004). Recovery of these areas is defined by Schroeder and Love (2004) as the point at which the community of organisms at the site of impact is indistinguishable from adjacent communities in similar substrates. A study carried out by MBC Applied Environmental Sciences (1987) estimated that the recovery of a soft sediment community around a decommissioned platform would take approximately 10 years. The site may or may not return to pre-impact conditions as a result of total rig removal. For more details regarding ecological impacts of various platform removal alternatives (i.e. partial removal, toppling, and no removal) see Schroeder and Love (2004). Use of platforms by fishermen and recreational divers that develop as a consequence of the newly developed biological communities would also cease after decommissioning (USDOI, MMS 2007).

21.2 SUSPENDED SEDIMENT AND SEDIMENTATION

Direct effects of suspended sediments on juvenile and adult fish are expected to be minimal and temporary, as they are motile and can move out of the affected areas. Planktonic fish eggs and larvae are affected by increased suspended sediments via gill clogging and other mechanisms (Wilber and Clarke 2001). Mortality and sublethal effects are dependent on concentration and exposure duration (Wilbur and Clarke 2001). Demersal fish eggs may be buried by deposition of suspended sediment, with mortality resulting from smothering. Increased suspended sediments can also impact the food web, though effects are expected to be short-term and localized. Turbidity can result in short term decreases in photosynthesis effecting primary productivity (Vermaat et al. 1997) and deposition of suspended sediments can smother benthos leading to a temporary loss of forage items for fish species. Increased suspended sediments resulting from drilling activities are discussed in [section 21.4](#).

21.3 INCREASED VESSEL TRAFFIC AND WATER USAGE

Entrainment and impingement of organisms is a major concern when utilizing sea water if the quantity of seawater use is large. Major sources of consumption include intake for platform operations and shipping operations, both cooling water and ballast water. Of these, ballast water is the largest component and impacts to the plankton communities will depend on the volume of ship traffic to any given location. Cargo vessels take on or release large quantities of ballast water when on- and offloading. This major consumption of water results in the entrainment of pelagic fish eggs and larvae, which are either killed or transported to a new location (USDOJ, MMS 2007). Small pelagic eggs and larval stages of fish can be entrained while medium sized organisms would be impinged at the intake. Impacts to localized fish populations, via ichthyoplankton entrainment, have the potential to be significant if water usage is large and continuous over a long time period. Additionally, loss of young individuals can have impacts on future production of the population and food web.

Direct mortality of ichthyoplankton from vessel traffic has been documented in rivers and other enclosed systems (Killgore et al. 2001; Pearson 1989), with a good discussion of the background in Killgore (2000). These effects can be from vessel generated turbulence and shear, impacts on the hull and propeller, abrasion, waves and drawdown (Pearson 1989). Killgore et al. (2001) simulated propeller shear effects on riverine fish species with shear stress levels between 634 and 5,743 dynes/cm² (for comparison towboat propeller shear stress in navigable rivers can be greater than 5,000 dynes/cm²). Mortality was linear with shear stress, and smaller larvae had higher mortalities than larger larvae. However, comparable field data on vessel induced mortality is lacking; the following examples are from river systems. Odum et al. (1992) found that handling mortality and variation in live larvae samples may have been larger than the vessel mortality effects. Holland (1986) found damage to eggs but not to larvae or small fish. Gutreuter et al. (2003) developed a methodology for estimating mortality rates in confined river channels from mortality data sampled following towboats in combination with dispersion modeling, used by EPA in the 2007 decision that “towboat traffic is a source of incidental mortality to adult pallid sturgeon.” Comparable studies are not available for coastal waters. Mortality estimates during critical fish reproduction and migration periods would be best for estimation of any effects.

Another impact of water usage and increased vessel traffic is the transportation of species between water bodies. The continued introduction of alien species is a major concern on the West Coast of the United States, with Los Angeles/Long Beach Harbor being one of the busiest ports in the country. While species transport between the OCS and the mainland is not a major concern, as most species are likely to be found in both locations, any vessel originating from other locations could potentially bring new invasive species to the area. Adverse impacts of invasive species include declining native populations and alterations in the food web (USDOJ, MMS 2007).

21.4 DRILLING MUDS AND CUTTINGS

Drilling cuttings and fluids (muds) are discharged as part of exploratory and developmental drilling. Cuttings are particles of crushed sedimentary rock that accumulate on the sediment

around the drill site. Cutting piles can alter the physical state of the seabed which may lead to shifts in species assemblage and composition (Raimondi et al. 1997). Drilling fluids are mixtures of many materials suspended in water which can locally decrease water quality by increasing suspended sediment and pollutant concentrations. Fish eggs and larvae are potentially at risk, and adult fish populations can be impacted due to lost recruitment due to egg and larvae mortality, as well as to loss of benthic invertebrate forage base (Hyland et al. 1994).

21.5 WASTEWATER

Produced water, a waste product of oil production, is also discharged into the surrounding environment. This fluid, which contains more salt than seawater, may also contain other contaminants. Oil and gas reservoirs have a natural water layer that lies under the hydrocarbons. During extraction, additional water is injected into the reservoirs to force oil to the surface. At the surface, the water is separated from the hydrocarbons by treating it with various chemicals, and then discharged into the sea. There is little evidence of long-term extensive harm to the marine environment from produced water, although eggs and larval stages of fish may be at risk from produced water depending on exposure and concentration (Washburn et al. 1999).

21.6 NOISE AND VIBRATION

Distribution of fish surrounding a construction area would most likely be affected by noise. Noise impacts on marine life depend on loudness, the specific acoustic frequency pattern at a given location, the distance of an organism from a sound source, and an organism's particular hearing sensitivity (USDOI, MMS 2000). Pile driving during platform construction is the source of most concern for increased underwater noise and vibration. The effects of sound from marine pile driving on fish are not well known. Most fish would move away from such disturbance, but those close enough may be harmed or killed (Thomsen et al. 2006). There have been some studies of exposure to pile-driving sounds, but the results were inconclusive (Hastings and Popper 2005). The noise generated from pile driving could affect fishes for some distance surrounding the work location. Some effects that have been observed include altered hearing and temporary behavioral changes, such as avoidance (Popper et al. 2006). The research that has been done shows that the degree of damage may not be directly related to the distance of the fish from the pile, but to the received level and duration of the sound exposure (Popper et al. 2006). Certain fish with sensitive hearing and swim bladder adaptations may be more vulnerable (USDOI, MMS 2007). In addition, increased noise levels are expected during construction activities due to increased vessel traffic, but only temporary effects to the nearby fish population are expected from vessel movements.

21.7 ARTIFICIAL LIGHTING

Platforms would be outfitted with operational night time lights. Some fish species are nocturnal feeders and may be disturbed by lights shining on the surface, while other species could be attracted to artificial light (USDOI, MMS 2007). However, there is little information available about the potential effects of such lighting on offshore fish populations (USDOI, MMS 2007).

21.8 CHEMICAL CONTAMINATION AND OIL SPILLS

Antifouling paints and biocide coatings are used to keep organisms from growing on structures submerged in the water. The use of antifouling paint on parts of the oil platform has the potential to impact the water quality by leaching chemicals which can bioaccumulate in lower trophic organisms in the immediate vicinity. Fish that graze on biofouling organisms could potentially be at risk via bioaccumulation; but most studies investigating this potential impact focus on marinas (Schiff et al. 2007) where large surface areas covered in this paint can have a large impact on the environment. The large source and the protected nature of waters around marinas result in high leaching rates and low flushing rates (Schiff et al. 2007). Therefore this impact is likely to be negligible at offshore platforms, where leaching chemicals will be quickly diluted.

Another source of toxicity could be due to subsurface exhaust from combustion engines. The Food and Agriculture Organization of the United Nations warns “The damage caused by the propeller to the zooplankton is relatively low, but considerable losses may be caused by combustion engines whose exhausts are blown under the water surface” (<http://www.fao.org/DOCREP/003/W3732E/w3732e0s.htm>). The supporting research was not quoted. There has been research on subsurface exhausts of 2-cycle engines (Tjärnlund et al. 1995) that found significant toxicity in fish.

Spills associated with offshore gas and oil development result mainly from vessel releases, platform blowouts, and pipeline breaks. Currently there are several offshore oil operations conducted from platforms in Federal waters off the coast of Southern California. To date, the largest oil spill from offshore oil operations in California was the 1969 80,000 barrel Santa Barbara spill (McCrary et al. 2003). Only a few small spills have occurred since 1969. The projections of oil production and exploration in the next few decades indicate increased risk of spill events (McCrary et al. 2003).

Oil impacts all life stages of fish (eggs, larvae, juveniles, and adults), mainly through the uptake of the toxic dissolved components released in the water column. Uptake mechanisms include ingestion of contaminated prey, as well as directly through the gills and epithelium. Depending on turbulence from wind and wave action and other physical conditions, oil can be mixed into the water column (entrainment). Exposure to microscopic entrained oil droplets may either mechanically impact fish species or act as a conduit for exposure to toxic dissolved components (French-McCay 2009). Fish eggs and larval stages found near the sea surface are at risk of direct contact with floating slicks and entrained droplets in the wave-mixed layer.

The most acutely toxic components of oil to fish are low molecular weight compounds, which are both volatile and soluble in water, especially the aromatic hydrocarbons (Neff et al. 1976; Rice et al. 1977; Malins and Hodgins 1981; Neff and Anderson 1981; Anderson 1985; McAuliffe 1987; French-McCay 2002; NRC 2003). Exposure to dissolved aromatic hydrocarbons results in uptake and accumulation in tissue and disruption of cellular functions (French-McCay 2009). Impact of aromatic hydrocarbon plumes on fish is dependent on exposure, physical conditions, oil type, concentration, and species sensitivity. Because accumulation of toxic concentrations within tissues takes only hours to days before lethal levels

are reached, a high level of turbulence is required to dissolve quantities of aromatic hydrocarbons that would be sufficient to induce toxicity. There is ample literature indicating that all aquatic biota will suffer adverse effects from uptake if exposure concentrations are high enough, and duration is long enough, for accumulation in tissues to become toxic (French-McCay 2002).

In some cases impacts on fish assemblages from aromatic hydrocarbon plumes would be measurable, but localized and temporary. Population level impacts may result when spills occur in turbulent shallow-water areas (i.e. near shorelines) during spawning events. Fish species that have localized spawning strategies, for example many rocky intertidal species (i.e. sculpin, blenny, and kelpfish), are most at risk (French-McCay 2009; Horn and Martin 2006). In general, fish that spawn in intertidal and shallow habitats (i.e. California grunion) are more vulnerable to oil toxicity as compared to most offshore pelagic and demersal spawners. However, pelagic fish species with neustonic (sea-surface dwelling) eggs and larval stages (i.e. members of the flying fish family, Exocoetidae) would be exceptions and highly vulnerable to exposure to spilled oil.

Direct contact of floating oil with most organisms results in mortality via smothering. Several species of fish have egg or larval stage(s) that are explicitly or partially neustonic. In particular, larval stages of members of the flying fish family (Exocoetidae) inhabiting the Southern California Bight are neustonic (Gruber et al. 1982). The direct contact of a surface slick and/or entrained oil droplets with neustonic eggs and larvae would result in high mortality (Longwell 1977).

21.9 HYDROGEN SULFIDE

Release of hydrogen sulfide into the aquatic environment is possible when “sour” or sulfur-rich oil is discovered (USDOI, MMS 2002). Most adult and juvenile fish will avoid areas of hydrogen sulfide contamination in the water column, but some mortality may result, dependent on concentrations and exposure. Passive fish eggs and larvae in the plume are at most risk of contamination and mortality (USDOI, MMS 2002).

21.10 THREATENED AND ENDANGERED SPECIES

Species of special concern, including those on State and Federal threatened and endangered species lists, are generally more vulnerable to impacts of any sort. Characteristics that result in the listing of these species, including low population numbers, poor reproductive success, limited habitat, small home ranges, and low genetic diversity, make them susceptible to disturbances in their environment. As a result, threatened and endangered species are more likely to be negatively impacted by oil and gas development than nonlisted species. Endangered and threatened fish species listed under the Endangered Species Act (ESA) occurring in the marine and estuarine habitats of the Southern Study Area are the green sturgeon (*Acipenser medirostris*), the tidewater goby (*Eucyclogobius newberryi*), and the Southern California evolutionarily significant unit (ESU) of West Coast steelhead (*Oncorhynchus mykiss*). Of the three species discussed in the resources section ([section 7.4](#)) none are at an increased risk of disturbance due to offshore oil and gas installation, operation, or removal activities. These three species are primarily found in coastal systems as opposed to offshore shelf areas where a majority of oil and

gas activities would take place. Federal and State critical habitat designations for all three species are restricted to nearshore coastal waters, coastal lagoons, river mouths, estuaries, and shallow bays of the Southern Study Area (USDOJ, USFWS 2008). Nearshore construction activities in these areas, such as pipeline installation, may result in negative impacts to these species. The highest risk for these animals occurs in the event of an oil spill. [See section 21.8](#) for further detail on impacts of oil spills on fish species.

21.11 SUMMARY AND DATA GAPS

The rocky subtidal and intertidal areas of Southern California are some of the most ecologically valuable habitats on the West Coast. The fish populations of these habitats are unique in their adaptations and survival strategies. Because of their specialized nature, they are also very vulnerable to the impacts of oil and gas development in addition to other natural and human induced stressors. Future research should include monitoring and measuring the response of rocky subtidal and intertidal fish communities to additive effects of development, oil spills, climate change, and climate regime shifts.

Sensitivity of fish eggs and larvae to toxic, or potentially toxic, byproducts of oil and gas development such as produced water and drill cuttings is an area of research needing further attention.

21.12 LIST OF LITERATURE CITED—FISH

- Anderson, J.W. 1985. Toxicity of dispersed and undispersed Prudhoe Bay crude oil fractions to shrimp, fish, and their larvae. API Publ. 4441. Washington, DC: American Petroleum Institute. 52 pp.
- French-McCay, D.P. 2002. Development and application of an oil toxicity and exposure model, OilToxEx. *Environmental Toxicology and Chemistry* 21:2080-2094.
- French-McCay, D. 2009. State-of-the-art and research needs for oil spill impact assessment modeling. In: *Proceedings of the 32nd Arctic and Marine Oil Spill Program (AMOP) Technical Seminar on Environmental Contamination and Response*, Vancouver, BC, Canada. Emergencies Science Division, Environment Canada, Ottawa, ON, Canada: in press.
- Govoni, J.J., M.A. West, L.R. Settle, R.T. Lynch and M.D. Greene. 2008. Effects of underwater explosions on larval fish: Implications for a coastal engineering project. *Journal of Coastal Research* 24(2):228-233.
- Gruber, D., E.H. Ahlstrom and M.M. Mullin. 1982. Distribution of ichthyoplankton in the Southern California bight. *California Cooperative Oceanic Fisheries Investigations (CalCOFI) Reports* 23: 172-179.
- Gutreuter, S., J.M. Dettmers and D.H. Wahl. 2003. Estimating mortality rates of adult fish from entrainment through the propellers of river towboats. *Transactions of the American Fisheries Society* 132:646-661.

- Hartman, A.R. 1987. Movement of scorpion fishes (*Scorpaenidae: Sebastes and Scorpaena*) in the Southern California Bight. California Dept. of Fish and Game 73:68-79.
- Hastings, M.C. and A.N. Popper. 2005. Effects of sound on fish. Subconsultants to Jones & Stokes, prepared for California Dept. of Transportation. Contract No. 43A0139.
- Helvey, M. 2002. Are Southern California oil and gas platforms essential fish habitat? ICES Journal of Marine Science 59:S266-S271.
- Holland, L.E. 1986. Effects of barge traffic on distribution and survival of ichthyoplankton and small fishes in the upper Mississippi River. Transactions of the American Fisheries Society 115:162-165.
- Horn, M.H. and K.L.M. Martin. 2006. Chapter eight: Rocky intertidal zone. In: Allen, L.G., D.J. Pondella, and M.H. Horn, eds. Ecology of marine fishes: California and adjacent waters. Berkeley, CA: University of California Press. Pp. 205-226.
- Hyland, J., D. Hardin, M. Steinhauer, D. Coats, R. Green and J. Neff. 1994. Environmental impact of offshore oil development on the Outer Continental Shelf and slope off Point Arguello, California. Marine Environmental Research 37(2):195-229.
- Killgore, K., S.T. Maynard, M.D. Chan and R.P. Morgan, II. 2000. Interim Report for the Upper Mississippi River–Illinois Waterway System Navigation Study: Evaluation of Propeller Induced Mortality on Early Life Stages of Selected Fish Species. U.S. Army Corps of Engineers, ENV Report 30. 24 pp.
- Killgore, K., S.T. Maynard, M.D. Chan and R.P. Morgan, II. 2001. Evaluation of propeller-induced mortality on early life stages of selected fish species. North American Journal of Fisheries Management 21:947-955.
- Lissner, A.L., G.L. Taghon, D.R. Diener, S.C. Schroeter, and J.D. Dixon. 1991. Recolonization of deep water hard substrate communities–Potential impacts from oil and gas development. Ecological Applications 1(3):258-267.
- Longwell, A.C. 1977. A genetic look at fish eggs and oil. Oceanus 20(4):46-58.
- Love, M.S., J.E. Caselle and L. Snook. 2000. Fish assemblages around seven oil platforms in the Santa Barbara Channel area. Fishery Bulletin 98:96-117.
- Love, M.S., J. Hyland, A. Ebeling, T. Herrlinger, A. Brooks and E. Imamura. 1994. A pilot study of the distribution and abundance of rockfishes in relation to natural environmental factors and an offshore oil and gas production platform off the coast of Southern California. Bulletin of Marine Science 55:1062-1085.
- Love, M.S., D.M. Schroeder, and M.M. Nishimoto. 2003. The ecological role of natural reefs and oil and gas production platforms on rocky reef fishes in Southern California: Synthesis of information. U.S. Dept. of the Interior, United States Geological Survey, Biological

- Resources Division. Prepared for U.S. Dept. of the Interior, Minerals Management Service. OCS Study MMS 2003-032.
- Love, M.S., D.M. Schroeder and W.H. Lenarz. 2005. Distribution of Bocaccio (*Sebastes paucispinis*) and cowcod (*Sebastes levis*) around oil platforms and natural outcrops off California with implications for larval production. *Bulletin of Marine Science* 77(3):397-408.
- Malins, D.C. and H.O. Hodgins. 1981. Petroleum and marine fishes: A review of uptake, disposition, and effects. *Environmental Science & Technology* 15(11):1272-1280.
- MBC Applied Environmental Sciences. 1987. Ecology of oil/gas platforms offshore California. U.S. Dept. of the Interior, Minerals Management Service, Pacific OCS Region, Camarillo, CA. OCS Study MMS86-0094.
- McAuliffe, C.D. 1987. Organism exposure to volatile/soluble hydrocarbons from crude oil spills—A field and laboratory comparison. In: *Proceedings of the 1987 International Oil Spill Conference*. Washington, DC:American Petroleum Institute. Pp. 275-288.
- McCrary, M.D., D.E. Panzer and M.O. Pierson. 2003. Oil and gas operations offshore California: Status, risks, and safety. *Marine Ornithology* 31(1):43-49.
- National Research Council (NRC). 2003. *Oil in the sea III: Inputs, fates and effects*. Washington, DC: National Academy Press. 446 pp.
- Neff, J.M. and J.W. Anderson. 1981. *Response of marine animals to petroleum and specific petroleum hydrocarbons*. Applied Science Publishers Ltd., London and Halsted Press Division, John Wiley & Sons, NY. 177 pp.
- Neff, J.M., J.W. Anderson, B.A. Cox, R.B. Laughlin, Jr., S.S. Rossi and H.E. Tatem. 1976. Effects of petroleum on survival respiration, and growth of marine animals. In: *Sources, effects and sinks of hydrocarbons in the aquatic environment*. Washington, DC: American Institute of Biological Sciences. Pp. 515-539.
- Newell, R.C., L.J. Seiderer, N.M. Simpson and J.E. Robinson. 2004. Impacts of marine aggregate dredging on *benthic macrofauna* off the southern coast of the United Kingdom. *Journal of Coastal Research* 20(1):115-125.
- Odum, M.C., D.H. Orth and L.A. Nielsen. 1992. Investigation of barge-associated mortality of larval fishes in the Kanawha River. *Virginia Journal of Science* 43:41-45.
- O’Keefe, D.J. 1984. Guidelines for predicting the effects of underwater explosions on swimbladder fish. Naval Surface Weapons Center, Final Report, Silver Spring, MD, NSWC TR 82-326.

- Pearson, W.D. 1989. Environmental Impact Research Program: Environmental Effects of Navigation Traffic: Studies on Fish Eggs and Larvae. Army Engineer Waterways Experiment Station Vicksburg, MS, Environmental Lab (abstract available only).
- Popper, A.N., T.J. Carlson, A.D. Hawkins, B.L. Southall and R.L. Gentry. 2006. Interim criteria for injury of fish exposed to pile driving operations: A white paper. Internet website: www.wsdot.wa.gov/NR/rdonlyres/84A6313A-9297-42C9-BFA6-750A691E1DB3/0/BA_PileDrivingInterimCriteria.pdf. Accessed May 2009.
- Raimondi, P.T., A.M. Barnett and P.R. Krause. 1997. The effects of drilling muds on marine invertebrate larvae and adults. *Environmental Toxicology and Chemistry* 16(6):1218-1228.
- Rice, S.D., J.W. Short and J.F. Karinen. 1977. Comparative oil toxicity and comparative animal sensitivity. In: Wolfe, D.A., ed.. *Fate and effects of petroleum hydrocarbons in marine ecosystems and organisms*. New York: Pergamon Press. Pp. 78-94.
- Schiff, K., J. Brown, D. Diehl and D. Greenstein. 2007. Extent and magnitude of copper contamination in marinas of the San Diego region, California, USA. *Marine Pollution Bulletin* 54(3):322-328.
- Schroeder, D.M. and M.S. Love. 2004. Ecological and political issues surrounding decommissioning of offshore oil facilities in the Southern California Bight. *Ocean and Coastal Management* 47:21-48.
- Thomsen, F., K. Ludemann, R. Kafemann and W. Piper. 2006. Effects of offshore wind farm noise on marine mammals and fish. Prepared by Biola, Hamburg, Germany, for COWRIE, Ltd. Internet website: <http://www.offshorewind.co.uk>. Accessed May 2009.
- Tjärnlund, U., G. Ericson, E. Lindesjö, I. Petterson and L. Balk. 1995. Investigation of the biological effects of 2-cycle outboard engines' exhaust on fish. *Marine Environmental Research* 39:313-316.
- U.S. Dept. of the Interior, Minerals Management Service (MMS). 2000. Environmental assessment of the Gulf of Mexico deepwater operations and activities. U.S. Dept. of the Interior, Minerals Management Service, Gulf of Mexico OCS Region, New Orleans, LA. OCS EIS/EA MMS 2000-001.
- U.S. Dept. of the Interior, Minerals Management Service (MMS). 2002. Gulf of Mexico OCS oil and gas lease sales 189 and 197, Eastern Planning Area, draft environmental impact statement, Vol. I: Chapters 1-8 and appendices. U.S. Dept. of the Interior, Minerals Management Service, Gulf of Mexico OCS Region, New Orleans, LA. OCS EIS/EA 2002-056.
- U.S. Dept. of the Interior, Minerals Management Service (MMS). 2005. Survey of invertebrate and algal communities on offshore oil and gas platforms in Southern California. U.S. Dept. of the Interior, Minerals Management Service, Pacific OCS Region, Camarillo, CA. MMS 2005-070.

- U.S. Dept. of the Interior, Minerals Management Service (MMS). 2007. Programmatic environmental impact statement for alternative energy development and production and alternate used of facilities on the Outer Continental Shelf, Vol. I: Executive summary through chapter 4. U.S. Dept. of the Interior, Minerals Management Service. OCS EIS/EA MMS 2007-046.
- U.S. Dept. of the Interior, United States Fish and Wildlife Service (USFWS). 2008. Endangered Species Program: Species Information. Internet website: <http://www.fws.gov/endangered/wildlife.html#Species>. Accessed June 2009.
- Vermaat, J.E., N.S.R. Agawin, M.D. Fortes, J.S. Uri, C.M. Duarte, N. Marba, S. Enriquez and W. Van Vierssen. 1997. The capacity of seagrasses to survive increased turbidity and siltation: The significance of growth form and light use. *Ambio* 26(8):499-504.
- Viada, S.T., R.M. Hammer, R. Racca, D. Hannay, M.J. Thompson, B.J. Balcom and N.W. Phillips. 2008. Review of potential impacts to sea turtles from underwater explosive removal of offshore structures. *Environmental Impact Assessment Review* 28:267-285.
- Washburn, L., S. Stone and S. MacIntyre. 1999. Dispersion of produced water in a coastal environment and its biological implications. *Continental Shelf Research* 19(1):57-78.
- Wilber, D.H. and D.G. Clarke. 2001. Biological effects of suspended sediments: A review of suspended sediment impacts on fish and shellfish with relation to dredging activities in estuaries. *North American Journal of Fisheries Management* 21:855-875.

22. SEA TURTLES

Sea turtle populations have been devastated by the impacts of anthropogenic activities, resulting in the listing of all species as either threatened or endangered. While fishing has the largest impact on these species, activities related to oil and gas development are also an important part of the cumulative impact (NRC 1985; NRC 2003). Vessel strikes and oil platform removal are two sources of effects associated with oil and gas development that have important effects on these species. Vessel strikes affect juveniles and adults at a medium impact level and oil platform removal affects mainly adults at a low level (Milton and Lutz 2003). Other impacts may result from noise and vibration from drilling activities; wastewater discharge; accidental fuel leaks and spills; discharge of drilling cuttings, fluids, and produced water; and the leaching of chemicals from the installed structures (paints, antifouling agents).

22.1 NOISE AND VIBRATIONS

Installation of offshore platforms includes surveying, pile driving, dredging, and pipeline laying, all of which result in increased noise levels, degradation of water quality, and increased vessel traffic. Before the installation of structures, activities associated with siting surveys may impact sea turtles. Two methods of surveying are airgun surveys and side-scan sonar (USDOI, MMS 2007). Airgun surveys generate low-frequency noise that may be detectable to sea turtles whose hearing is limited to low frequencies (Lutz et al. 2003; USDOI, MMS 2007). Side-scan sonar generates noise at a higher frequency and at a lower intensity than airgun surveys and is not likely to disturb normal activities. Conversely, construction noise generated by pile driving is louder and audible over a broader band (USDOI, MMS 2007). While these sounds could cause injury or changes in behavior, sea turtles are highly mobile and it is believed they would avoid construction activities and stay outside the range of auditory impact. Operational noise and vibrations are not likely to be more than those generated during installation and thus a similar avoidance response is presumed.

In environmental assessments of offshore activities, the National Marine Fisheries Service (NMFS) recommends that all noise sources be characterized, any impulsive underwater sound sources greater than 160 decibels relative to one micropascal (dB re 1 μ Pa) or any continuous underwater sound sources greater than 120 dB re 1 μ Pa be quantitatively described (e.g., in intensity, duration, or frequency range), and these be evaluated for potential impacts to sea turtles. Pile driving is often considered the activity most likely to produce the loudest sounds, on the order of 200 dB re 1 μ Pa, measured at 30 m from the source (Michel et al. 2007).

Table 22.1.

Sound Pressure Levels from Underwater Noise Sources

Impact Type	Sound Pressure Levels
Potential Injury	180 dB re 1 μ Pa
Potential Harassment from Impulsive Noise	166 dB re 1 μ Pa
Potential Harassment from Continuous Noise	120 dB re 1 μ Pa

Note: Evaluation of potential impacts is recommended by NMFS².

The removal of offshore platforms includes many of the same procedures as the installation. The structures and decks above the surface are taken apart and shuttled to disposal sites via barges; this activity generates increased vessel traffic. The platform legs, wellheads, flare piles, conductors, submerged wells, caissons, and all other submerged structures then need to be removed to at least 5 m below the sea floor. In many cases, this requires explosive removal. There are several common explosive removal techniques, including bulk explosive charges, configured bulk charges, and cutting charges (Viada et al. 2008). An explosion's impact on any organism is dependent on the distance between the two. Viada et al. (2008) review the potential sources and causes of impacts to sea turtles due to underwater explosions associated with the removal of oil and gas structures. Noninjurious effects include acoustic annoyance and tactile detection or physical discomfort while injurious effects include damage to organs (Viada et al. 2008). Primary blast injuries are usually limited to gas-containing organs (lungs and auditory system), whereas cavitations, the rarefaction waves in the water column, mostly cause noninjurious effects or may increase the impact of a primary blast injury. Nonlethal injuries include permanent damage to the auditory system, commonly leading to hearing loss, and lung hemorrhage. Lethal injuries are a direct result of close proximity to the point of detonation and include extensive lung hemorrhage and associated gastrointestinal tract injuries. Additionally, exposure to peak shock waves can result in brain damage and fractures to the skeleton (Viada et al. 2008). Viada et al. (2008) summarize the little research conducted and sightings of injuries resulting from underwater explosions over the past 30 years.

22.2 INCREASED VESSEL TRAFFIC

Increased vessel traffic could be a large source of injury or mortality, especially if traffic is increased during peak times of migration. Leatherbacks and loggerheads are commonly sighted foraging off the coast of Northern California in autumn months (Carretta et al. 2005; Peterson et al. 2006; USDOC, NMFS 2009) and since these species do not reside in this area, a migration route must exist between Northern California and warmer equatorial waters. Increased numbers of turtles during migration events could lead to increased vessel strikes during these time periods. It is not known how sea turtles are affected by the increased noise generated by increased vessel traffic, though it is assumed there must be some temporary impacts (USDOC, NMFS 2002). Adult turtles may avoid areas of high traffic and dive at the approach of a vessel.

² NOAA Program Planning and Integration, letter from Mr. Steve Kokkinakis, NEPA Coordination and Compliance, to Mr. Mark Prescott, U.S. Coast Guard, December 24, 2008.

Turtles are generally assumed to be unable to differentiate between prey items and debris in the water. Experiments have shown them to strike at nonfood sources (Vargo et al. 1986), and gut content analyses found over 50 percent of turtles examined had consumed plastics (Boyle and Limpus 2008). Rogue debris from vessels or platforms can entangle turtles or be mistaken for prey, and both can cause injury or death (NRC 1990; Lutz and Musick 1997; Lutz et al. 2003). While the dumping of plastics is prohibited, increased human activity ultimately leads to increased gear loss and accidental debris release.

Vessels and platforms utilize bright lighting. The age class most sensitive to artificial lighting is hatchlings, because they use light cues to orient their migration to foraging areas (Witherington and Martin 1996). In addition to taking these animals away from their natural movements, the lights may also attract birds and fish that prey on the hatchlings, further reducing their survival rate (Michel et al. 2007).

22.3 ENTANGLEMENT

In conjunction with increased vessel traffic to and from installations, there are typically increased numbers of moored vessels around the installation site, which would increase the number of mooring lines in the water. Turtles can become entangled and subsequently become injured or drown after striking a mooring line (Michel et al. 2007). Since turtles are slow swimmers, it is not likely they will become entangled in the mooring lines of construction vessels if they are avoiding the area due to increased noise.

22.4 DRILLING MUDS AND CUTTINGS

Drilling cuttings and fluids are discharged as part of exploratory and developmental drilling. Cuttings are particles of crushed sedimentary rock that accumulate on the sediment around the drill site. Drilling fluids are mixtures of many materials suspended in water or an oil-based medium. While oil-based drilling fluids have never been permitted for discharge (NRC 2003), cuttings and water-based fluids could locally decrease water quality by increasing suspended sediment and pollutant concentrations. Produced water, a waste product of oil production, is also discharged into the surrounding environment. This fluid, which contains more salt than seawater and may also contain a multitude of contaminants, has been shown to negatively affect the fouling community on structures nearby (NRC 2003). Negative effects on the fouling community, including reduced growth or accumulation of contaminants, are anticipated only in close proximity to the discharge. This could indirectly affect turtles if they consume prey that had been contaminated by the drilling fluids and produced water.

Localized and temporary decreases in water quality caused by suspension of sediments are not likely to have a major impact on sea turtles, since the turtles breathe air. However, decreased visibility due to decreased water quality could impair navigation and feeding, but again it is presumed these animals will avoid construction areas.

22.5 WASTEWATER

Wastewater discharge could pose a problem if artificially warmed water is released into the environment on a regular basis. The thermal effluent of power plants in San Diego and Los

Angeles has attracted year-round green turtle residents (USDOC, NMFS & USDO, USFWS 1998; Sahagun 2008). If platforms were providing a constant source of warm water they could attract individuals to the location. Accidental fuel leaks are likely to affect turtles in the same way a spill would (see below); if turtles are seeking platforms for other reasons (e.g. increased prey abundances) the probability of exposure increases.

22.6 CHEMICAL CONTAMINATION AND OIL SPILLS

Antifouling paints and coatings are used to keep organisms from growing on structures submerged in the water. While some parts of an oil platform will not be affected by the presence of attached organisms, the use of antifouling paint on other parts has the potential to affect water quality and cause bioaccumulation of metals and organics in lower trophic level organisms in the immediate vicinity. Most studies investigating this potential issue focus on marinas, where pollutants from large surface areas covered in antifouling paint can have a large impact on the environment. The large surface areas of the sources and the protected (enclosed) nature of these areas create a scenario with high leaching rates and low flushing rates (Schiff et al. 2007). This is not likely to occur at offshore platforms, where leaching chemicals will be quickly diluted. While turtles may be attracted to these structures as sources of increased productivity, there is little chance the organisms living in the water column around these structures will be impacted by leaching chemicals.

Oil spills occurring during construction, operations, and removal activities, as well as chronic releases of crude oil and petroleum products, can adversely affect sea turtles. For a summary of the major oil spills where sea turtles have been affected, see Yender and Mearns (2003). Chronic small discharges are also a concern with respect to sea turtles, because of exposure to tarballs. National Research Council (2003) summarizes the sources and quantities of petroleum entering the marine environment that contribute to the background levels of tarballs existing in all oceans. Oil and gas activities in offshore areas result in increased densities of tarballs from chronic and intentional discharges, as well as from accidental spills. For turtles of all ages, ingestion of tarballs is a major issue because turtles eat anything that appears to be the same size as their preferred prey (Vargo et al. 1986). Like other pollution sources, tarballs accumulate in convergence zones, where sea turtles are often found feeding. Ingestion, both intentional (tarballs) and accidental (occurring when turtles surface in an oil slick), can result in starvation from gut blockage, decreased food absorption efficiency, absorption of toxins, buoyancy problems from buildup of fermentation gases, and many other effects (Milton et al. 2003).

Exposure to oil and its effects have been widely studied in many types of organisms. However, very little has been done to quantify exposure effects on sea turtles. Much of the research on this issue was funded by BOEMRE and is reported in Vargo et al. (1986). This synthesis suggests that toxic effects of oil exposure occur; however, these are often overlooked because they are small compared with the adverse impacts related to commercial fishing activities (Milton et al. 2003).

Exposure to toxic substances is likely to be most detrimental to the youngest stages. While there are no nesting beaches along the coast of the Southern California Bight, the Pacific beaches of Mexico are important habitats for several species, including the endangered population of green

turtles (USDOC, NMFS & USDO, USFWS 2007). Oil spilled within the Southern California Bight could be transported south to these beaches and adversely affect nesting success.

Effects of beach oiling include reduced hatching rates as well as developmental deformities (Fritts and McGehee 1982; Milton et al. 2003). However, since nests are laid above the high tide water mark, the chance of oil reaching turtle eggs and hindering their development is small (Fritts and McGehee 1982). Nonetheless, sea turtle nests could be destroyed during spill response and cleanup, unless carefully and successfully protected. Beach oiling has the potential to increase the temperature at nesting sites, which has the potential to change the hatching sex ratio, a temperature-dependent process. More vulnerable to oiling are the females and hatchlings as they move between the beach and the water. If oil is deposited on a beach, hatchlings can become oiled as they migrate from the nest to the water, which could lead to impaired movements and behaviors at sea. Similarly, if females are oiled as they haul out of the water to nest, there is the potential for physical oiling of the female and the transfer of that oil to her eggs as she lays her nest.

Oiling in the water column or at the surface is a risk for all ages of sea turtles, especially because turtles do not exhibit strong avoidance behaviors when encountering oil (Vargo et al. 1986; Milton et al. 2003). In behavior experiments, Vargo et al. (1986) concluded that juvenile turtles visually detected the presence of surface oil and responded by surfacing to breathe in unoiled areas and by spending more time in deeper water. However, turtles in these experiments were still oiled while breathing. The authors also note that if floating macroalgae, a preferred habitat for turtles, is mixed with oil the visual cues could be misconstrued, resulting in increased oiling (Vargo et al. 1986).

Contact with oil can irritate the skin and oil can get caught in the nostrils, mouths, and eyes of all age classes of turtles. This can result in labored breathing, impaired vision, and the accidental ingestion of oil. Oil on the skin can irritate the soft tissue around the eyes, neck, and flippers. Exposure experiments showed skin continued to slough off for up to 2 weeks after exposure to oil, and full recovery took up to 3 weeks (Vargo et al. 1986). Vargo et al. (1986) also found that physical oiling can also impair salt gland functions. The salt gland regulates ion balances in the body and its failure hinders the transport of salt and fluids out of the body; loss of fluids could lead to physiological stress.

Exposure to surface oil increases when more time is spent at the surface. Hatchlings spend more time on the surface than older turtles and are therefore at higher risk for contact with oil slicks (Milton et al. 2003). First, since smaller turtles have more limited motility they are often caught by the same currents as oil slicks and end up in convergence zones more frequently than juveniles or adults (Milton et al. 2003). Finally, hatchlings would be the most vulnerable because only a small amount of oil is needed to completely coat them. Additionally, once oiled, hatchlings may not be able to swim as well, which increases their predation risk.

22.7 AIR EMISSIONS

Inhalation of vapor is of concern for turtles who exhibit diving behavior. Turtles that are preparing for a dive will inhale a large volume of air before submerging. Anything inhaled will then have a prolonged period of time to be absorbed or affect the animal. Sea turtles have not been shown to exhibit avoidance behavior when surrounded by petroleum fumes (Milton et al. 2003). Volatile hydrocarbons in petroleum are of concern to human health and can occur in concentrations above human health standards in areas affected by freshly spilled unweathered oil (NRC 1985; USDOC, NMFS 2002), and so would be a concern for any sea turtles within an area where fresh unweathered oil is on the water surface.

22.8 HYDROGEN SULFIDE

Hydrogen sulfide (H₂S) is a toxic gas that can be detected by humans at very low concentrations. Higher concentrations can damage the nervous system and be fatal. H₂S is produced naturally during the decay of organic material and is found in petroleum. California air quality standards require that hydrogen sulfide remain below 0.03 ppm as a 1-hour average (Collins and Lewis 2000). While the concentration at which sea turtles are affected by hydrogen sulfide is not documented, the human guidelines are set conservatively and therefore acute exposures to concentrations below the human health standards are not likely to adversely affect these animals. Atmospheric H₂S concentrations are not known to exceed human health standards after oil spills (NRC 1985).

22.9 ALTERATION OF THE MARINE FOOD WEB

The installation of rigid structures will increase the amount of hard substrate available to marine organisms for colonization. It is likely that many of these facilities will be built in areas with soft sediments and therefore the addition of a hard structure creates new habitat (Battelle 2004). This has the potential to support localized communities in areas otherwise uninhabitable by certain species. These new communities could offer a new source of food to sea turtles and attract them to oil platform locations. If sea turtles are attracted to the platforms to feed, they are at a higher risk of consuming prey contaminated with toxins because the water in the vicinity of the platform will be degraded due to accidental and intentional releases of produced water, drilling cuttings and muds, and oil spills. Thus the potential for bioaccumulation of toxins is increased when turtles are feeding in and around platforms (Milton et al. 2003; Gardner et al. 2006).

Sea turtles that feed in nearshore areas are at risk for consuming food contaminated by oil that has come ashore or fouled food items, such as oiled seagrasses. Additionally, the accumulation of hydrocarbons and other toxins in lower trophic levels released in association with oil and gas activities can bioaccumulate and become a large source of these toxins to turtles (Milton et al. 2003; Gardner et al. 2006). This phenomenon can occur at coastal areas that have been affected by a major spill or at the oil platform, resulting from the release of oil or other pollutants.

22.10 SUMMARY AND DATA GAPS

The Southern Study Area is home to green turtles and is part of a migration route for loggerheads and leatherbacks. Development for oil and gas in this region has the potential to negatively affect these resident and transient populations. Injury to these animals in this area could lead to reduced reproduction in other areas. This is of particular concern for the endangered eastern Pacific green turtle population.

There is a good body of literature that reports turtle life history and observations in the environment. It is also known that direct encounters with oil can adversely affect turtles. However, little exists regarding specific behavioral changes that result from encountering floating oil, which might affect future exposure as well as migratory and reproductive behavior. Understanding how turtles respond to oil slicks would allow for much more accurate assessment of impacts. Both short- and long-term data are needed to completely address this issue, as these long-lived individuals could cease to return to a given location if an oil slick had previously been encountered.

22.11 LIST OF LITERATURE CITED—SEA TURTLES

- Battelle. 2004. Marine Biological Assessment for the Cape Wind Project, Nantucket Sound. U.S. Army Corps of Engineers. APP. 5.5-A.
- Boyle, M. and C. Limpus. 2008. The stomach contents of post-hatchling green and loggerhead sea turtles in the southwest Pacific: An insight into habitat association. *Marine Biology* 155 (2):233-241.
- Carretta, J., T. Price, D. Petersen and R. Read. 2005. Estimates of marine mammal, sea turtle, and seabird mortality in the California Drift Gillnet Fishery for Swordfish and Thresher Shark, 1996-2002. *Marine Fishery Review* 66(2):21-30.
- Collins, J. and D. Lewis. 2000. Hydrogen sulfide: evaluation of current California air quality standards with respect to protection of children. California Air Resources Board. Sacramento: California Office of Environmental Health Hazard Assessment.
- Fritts, T. and M. McGehee. 1982. Effects of petroleum on the development and survival of marine turtle embryos. U.S. Dept. of the Interior, U.S. Fish and Wildlife Service. FWS/OBS-82/37.
- Gardner, S., S. Fitzgerald, B. Vargas and L. Rodríguez. 2006. Heavy metal accumulation in four species of sea turtles from the Baja California Peninsula, Mexico. *BioMetals* 19(1):91-99.
- Lutz, P. and J. Musick. 1997. *Biology of sea turtles*. Boca Raton, FL: CRC Press.
- Lutz, P., J. Musick and J. Wynken. 2003. *Biology of sea turtles Volume II*. Boca Raton, FL: CRC Press.

- Michel, J., H. Dunagan, C. Boring, E. Healy, W. Evans, J. Dean, A. McGillis and J. Hain. 2007. Worldwide synthesis and analysis of existing information regarding environmental effects of alternative energy uses on the Outer Continental Shelf. U.S. Dept. of the Interior and Minerals Management Service. MMS OCS Report 2007-38.
- Milton, S. and M. Lutz. 2003. Natural and Human Impacts on Turtles. In: Shigenaka, G. Oil and sea turtles: Biology, planning, and response. National Oceanic and Atmospheric Administration (NOAA), NOAA's National Ocean Service, Office of Response and Restoration.
- Milton, S., P. Lutz and G. Shigenaka. 2003. Oil toxicity and impacts on sea turtles. In: Shigenaka, G. Oil and sea turtles: Biology, planning, and response. National Oceanic and Atmospheric Administration (NOAA), NOAA's National Ocean Service, Office of Response and Restoration.
- National Research Council (NRC). 1985. Oil and sea, inputs fates and effects. Washington, DC: National Academy Press.
- National Research Council (NRC). 1990. Decline of sea turtles: Causes and prevention. Washington, DC: National Academy Press.
- National Research Council (NRC). 2003. Oil in the sea III: Inputs, fates, and effects. Washington, DC: National Academy Press.
- Peterson, B., R.T. Emmett, R. Goericke, E. Venrick, A. Mantyla, S.J. Bograd, F.B. Schwing, R. Hewitt, N. Lo, W. Watson, J. Barlow, M. Lowry, S. Ralston, K.A. Forney, B.E. Lavaniegos, W.J. Sydeman, D. Hyrenbach, R.W. Bradley, P. Warzybok, F. Chavez, K. Hunter, S. Benson, M. Weise, J. Harvey, G. Gaxiola-Castro and R. Durazo. 2006. The state of the California Current, 2005-2006: Warm in the north, cool in the south. Reports of California Cooperative Oceanic Fisheries (CalCOFI) Investigations 47:30-74.
- Sahagun, L. 2008. Sea turtles explore new, urban frontier. Los Angeles Times. 30 August 2008: B-1.
- Schiff, K., J. Brown, D. Diehl and D. Greenstein. 2007. Extent and magnitude of copper contamination in marinas of the San Diego Region, California, USA. Marine Pollution Bulletin 54(3):322-328.
- U.S. Dept. of Commerce, National Marine Fisheries Service (NMFS). 2002. Endangered Species Act-Section 7 Consultation Biological Opinion. Gulf of Mexico Outer Continental Shelf Lease Sale 184. S.R.D. U.S. Dept. of Commerce, National Marine Fisheries Service (NMFS). Consultation # F/SER/2002/00145.
- U.S. Dept. of Commerce, National Marine Fisheries Service (NMFS). 2009. Revision of Critical Habitat for Leatherback Sea Turtles: Biological Report. U.S. Dept. of Commerce, National Marine Fisheries Service, Office of Protected Resources: November 2009.

- U.S. Dept. of Commerce, National Marine Fisheries Service (NMFS) and U.S. Dept. of the Interior, U.S. Fish and Wildlife Service (USFWS). 1998. Recovery Plan for U.S. Pacific Population of the East Pacific Green Turtle (*Chelonia mydas*). U.S. Dept. of Commerce, National Oceanic and Atmospheric Administration, National Marine Fisheries Service, U.S. Dept. of the Interior and U.S. Fish and Wildlife Service.
- U.S. Dept. of Commerce, National Marine Fisheries Service (NMFS) and U.S. Dept. of the Interior, U.S. Fish and Wildlife Service (USFWS). 2007. 5 Year Review of Green Turtles. U.S. Dept. of Commerce, National Oceanic and Atmospheric Administration (NOAA) and National Marine Fisheries Service (NMFS).
- U.S. Dept. of the Interior, Minerals Management Service (MMS). 2007. Programmatic environmental impact statement for alternative energy development and production and alternative use of facilities on the outer continental shelf. Final environmental impact statement. OCS EIS/EA MMS 2007-046. Vol II. 342 pp.
- Vargo, S., P. Lutz, D. Odell, E. Van Vleet and G. Bossart. 1986. Study of the effects of oil on marine turtles. Volume 1-3. Final report, 30 September 1983-1 October 1985. OCS Study MMS 86-0070.
- Viada, S., R. Hammer, R. Racca, D. Hannay, M. Thompson, B. Balcom and N. Phillips. 2008. Review of potential impacts to sea turtles from underwater explosive removal of offshore structures. Environmental Impact Assessment Review 28(4-5):267-285.
- Witherington, B. and R. Martin. 1996. Understanding, assessing, and resolving light-pollution problems on sea turtle nesting beaches Florida Department of Environmental Protection. Technical Report TR-2.
- Yender, R.A. and A.J. Mearns. 2003. Case studies of spills that threaten sea turtles. In: Shigenaka, G. Oil and sea turtles: Biology, planning, and response. National Oceanic and Atmospheric Administration (NOAA), NOAA's National Ocean Service, Office of Response and Restoration.

23. BIRDS

There were 44 oil spills in California between the years of 1969 and 2001 that each resulted in the collection of at least ten oiled seabirds (Carter 2003). About a quarter of those occurred in and around the Southern California Bight. Seabird mortality due to oil spills is hard to estimate because evidence is often not readily available and only small amounts of oil are needed to have deadly effects on these populations (Carter 2003; Hampton et al. 2003; McCrary et al. 2003). The effects on birds due to oil and gas development and oil spills are discussed below.

23.1 INCREASED VESSEL TRAFFIC

Installation of offshore platforms includes surveying, pile driving, dredging, and pipeline laying, all of which result in increased noise levels, degradation of water quality, and increased vessel traffic. The activities associated with support vessel traffic, helicopter flights, and barging can disturb birds at sea, but these effects would be limited to the immediate vicinity of the disturbance and would be very short in duration (e.g., a few minutes). Vessel traffic of various types is common throughout the project area, and seabirds have most likely become habituated to this activity (USDOI, MMS 2001). The seabirds that are likely the most sensitive to disturbance are those that are actively nesting. Shorebirds and wading birds would not be as affected by these activities, because they are restricted to the shoreline.

Helicopter flights can induce variable reactions by different species of birds. Reactions vary with species, colony size, previous exposure levels, location, altitude, number of flights, etc. (Hunt 1985). Disturbance by helicopters and low-flying aircraft can be a negative impact, although some seabirds may habituate to air traffic over time (Hunt 1985). Increased effects may occur in nesting areas, where low-flying aircraft can disturb nesting birds, resulting in the abandonment of nests. Although the nests may be abandoned for only a short time, this leaves the eggs or chicks exposed to the elements and predators. This was observed at several common murre (*Uria aalge*) colonies in central California, where vessels within 50 m of the nests were found to induce the most flushing of adults (Rojek et al. 2007). Birds that nest on offshore rocks and cliffs are especially vulnerable because they may accidentally cause their eggs or young to fall from cliff ledges when they take flight due to a low-flying helicopter (USDOI, MMS 2001). Helicopters may also disturb roosting birds, such as cormorants, gulls, and pelicans. Due to the high background level of aircraft flight activity that occurs throughout much of the Southern Study Area, however, birds may be habituated to this type of disturbance (USDOI, MMS 2001).

Increased vessel traffic results in a host of additional sources of risk to birds. While the dumping of plastics is prohibited, increased human activity ultimately leads to increased gear loss and accidental debris release. Birds can be injured or killed by rogue marine debris; birds either get entangled in it or mistake it for prey and consume it (Derraik 2002). This risk goes up when birds are attracted to platforms and vessels as potential sources of food; near platforms and vessels they are more likely to encounter marine debris. Similarly, with increased vessel traffic there is an increased risk for illegal discharges of oil from these ships. These more frequent yet small releases of oil can have large negative effects on bird populations as only a small amount of oil is needed to compromise the integrity of feathers (Hampton et al. 2003; Wiese and Robertson 2004; French-McCay 2009). Vessel traffic can also disturb and displace birds from

preferred habitats, which could then lead to permanent abandonment of the area and/or reduced reproductive success. Disturbance by vessels can cause individuals to take avoidance flights, which expend energy and detract from feeding activity, resulting in further decreased energy stores (USDOI, MMS 2007).

23.2 NOISE AND VIBRATIONS

The effects of noise are not commonly mentioned in environmental impact statements for oil and gas development. In general, it is assumed that construction and operational noise would cue avian resources to vacate the area and potentially avoid it entirely. While this may not be a noteworthy impact in many areas on the Outer Continental Shelf, in the Southern California Bight, feeding, nesting, and roosting areas are located throughout the region. These areas on and near the California Channel Islands are more likely to be affected by the noise associated with development because of their distribution throughout the bight and, thus, proximity to many of the areas available for lease. Effects detected at these islands are of particular importance because the islands provide nesting areas for a large number of species. Noise transmitted in the air due to pile driving and drilling will not likely cause more than minor effects of annoyance or avoidance. However, underwater noise generated by these activities could have a larger effect on diving seabirds because during feeding they are completely submerged. Varying responses to underwater sound in fish species have also been observed (Thomsen et al. 2006). This could indirectly affect seabirds if fish populations avoid common feeding grounds by potentially lowering fishing success, which could lead to starvation, mortality, and/or reduced breeding success.

Removal of offshore platforms includes many of the same procedures as does installation. The structures and decks above the surface are taken apart and shuttled to disposal sites via barges. This activity generates increased vessel traffic. The platform legs, wellheads, flare piles, conductors, submerged wells, caissons, and all other submerged structures then need to be removed to at least 5 meters below the sea floor. In many cases this requires explosive removal. There are several common explosive removal techniques, including bulk explosive charges, configured bulk charges, and cutting charges (Viada et al. 2008). The impact of an explosion on any organism depends on the distance between the two. To be killed or injured by an explosion, a bird would have to be submerged at the exact moment of the explosion. Birds at highest risk for injury are seabirds that forage underwater (USDOI, MMS 2001). These include grebes, loons, shearwaters, scoters, and alcids. Based on the damping effect of the explosions being below the sea floor and the very low probability that seabirds would be both submerged at the exact moment of an explosion and in close enough proximity to be killed or injured, the overall risk is low. Gulls might be attracted to the area by the dead fish that result from underwater explosions, but gulls feed on the surface and would not be affected (USDOI, MMS 2001).

23.3 INFRASTRUCTURE

The platforms erected to support oil and gas development provide additional structure and light to the relatively flat and uniform horizon of the open ocean. For seabirds these structures offer new stimuli, including habitat diversity and artificial sources of light (Wiese et al. 2001). The above-surface structures can offer places to roost while the underwater structures can support

increased prey abundances. Additionally, the lights can attract both seabirds and their prey at all hours. The attraction of seabirds to these structures can result in increased risk of injury or death due to the exposure to small oil spills, collision with structures, and starvation. Platforms are a source of chronic oiling to the environment; both accidental spills and intentional release of produced water can result in risky situations for birds in the area (Hampton et al. 2003; Fraser et al. 2006). While these spills are usually small, even small amounts of oil have the potential to injure or kill a seabird because of the small amount of oiling that is lethal and multiple pathways of impact (Hampton et al. 2003; see below). Seabird mortality due to collision with illuminated structures is common and heightened during inclement weather because birds are forced to reduce their altitudes and increase their flying densities (Wiese et al. 2001). Birds can also become disoriented in the illuminated area and will not leave, even if food is not present. This can result in death because of starvation. A complete review of the risks to seabirds associated with offshore platforms can be found in Wiese et al. (2001).

The amount of light associated with oil and gas development is high. Marine safety requirements result in bright lighting on vessels and platforms at night. Flaring also produces such a high intensity of light that it can be identified in satellite imagery (Wiese et al. 2001; Longcore and Rich 2004). The effects of artificial light on migratory behavior have been documented for centuries (Gauthreaux and Belser 2006). Recent work has shown that the wavelength and intensity of the light can affect how birds respond. Poot et al. (2008) found that green and blue light caused less disorientation than white and red light and that birds were more greatly affected on nights without other visual cues (e.g. moonlight, starlight). The authors replaced all the lights on a platform in the North Sea with lights in the green spectrum and report that preliminary results indicate that far fewer birds are attracted to the platform (Poot et al. 2008).

23.4 OIL SPILLS

Birds are highly vulnerable to oil spilled in coastal and marine environments. Oil spilled during construction, operation, and removal activities, as well as chronic releases of crude oil and petroleum products, can adversely affect all bird groups (Hampton et al. 2003; Fraser et al. 2006). The addition of structures and additional ship traffic increases the likelihood of vessel collisions and allisions of vessels with structures. However, documentation on the probability of oiling and mortality of oiled birds is not readily available due to difficulties in obtaining estimates. Accurate beach counts of dead animals are not enough, since many dead individuals sink or are consumed before being washed ashore (NRC 1985). The Beached Bird Model (Page et al. 1990; Carter et al. 2003) has been used to estimate total mortality from counts of oiled animals in several large oil spill cases in the United States (e.g., *Puerto Rican*, *Apex Houston*, *Exxon Valdez*, *Kure*, *New Carissa*, *Stuyvesant*, *Luckenback*). The calculations include corrections for losses at sea, losses on shorelines after beaching, background non-spill-related beaching rates, observational effort, and search success (Carter and Page 1989; Ford 1987; Ford et al. 1996; Ford et al. 2006). Results of detailed studies provide data for estimating probability of oiling if a bird is present in the area swept by oil. Despite physical oiling being a major pathway to injury or death, there is not a consistent relationship between spill volume and number of birds oiled (Hampton et al. 2003); better correlates with number of birds oiled are seabird density, wind direction and speed, wave action, distance to shore, and temperature (Burger 1993).

Oil can affect birds through several pathways, including direct oiling and ingestion of oil (NRC 1985; NRC 2003). When soiled by oil, plumage of most birds is compromised, resulting in the loss of the plumage's ability to repel water and insulate the animal (Stephenson 1997). Without this barrier birds are susceptible to drowning and hypothermia. Birds are also at risk of ingesting oil. Ingestion can occur when birds preen oil off of their plumage or when they consume prey in contaminated areas. Once ingested, oil can have varying pathological effects, including hormone imbalances, impaired water-sodium ion transfer, and reduced egg laying (NRC 1985; NRC 2003). A review of petrochemical ingestion and the stress it causes on the immune system can be found in Briggs et al. (1997). Oil exposure to the surface of eggs has also been shown to reduce the hatching rate (NRC 1985; NRC 2003).

Once oiled, it is generally agreed that birds have a very low survival rate, even when rescue and cleaning are attempted (Bourne et al. 1967; Croxall 1977; Ohlendorf et al. 1978; Chapman 1981; Ford et al. 1982; Samuels and Lanfear 1982; Varoujean et al. 1983; Ford 1985; Fry 1987; Seip et al. 1991; Anderson et al. 2000). Death may be due to loss of body heat, toxicity through the skin, or ingestion of toxins via grooming. A study of the behaviors of rehabilitated California brown pelicans (*Pelicanus occidentalis californicus*) found that birds had lower survival, no breeding activity for two years, and delayed post-breeding dispersal in the first year (Anderson et al. 1996). Another study found that two species, Cassin's auklet (*Ptychoramphus aleuticus*) and wedge-tailed shearwaters (*Puffinus pacificus*), immediately abandoned the breeding colony after being oiled and fewer females returned the following breeding season (Fry 1987).

The amount of oil needed to affect birds also varies with several factors, including species, oil type, and physical conditions. See Clark (1984) and Jenssen (1994) for reviews of the literature on oil effects on aquatic birds. One study found that when confined to oil, 1 g/m² is 100 percent lethal to birds while 0.1 g/m² is not enough to cause acute mortality (Varoujean et al. 1983). Another found that blue sheen (which is less than one micron thick; NRC 1985) is not harmful to seabirds (Peakall et al. 1985). Jenssen and Ekker (1991a,b) studied the effects of exposure of eiders to oil of varying doses. Greater than 20 ml of (crude) oil was the required dose for an effect on metabolism. However, Jenssen and Ekker's review of the literature revealed that an order of magnitude more oil is the required dose for significant and potentially lethal effects. French-McCay (2009) has estimated that the threshold thickness of oil needed to impart a lethal dose to bird is 10 microns (about 10 g/m²). This has been verified by modeling analyses of well-studied oil spills (French-McCay and Rowe 2004).

Probability of oiling depends on behavior, distribution, and reproductive rate (Huguenin et al. 1996). Characteristics that make certain bird species susceptible to oiling include: spending large periods of time on the water, weak flying capability such that they dive often, having flightless feather-molting stages, diving foraging behavior, and roosting at night on the water (Speich et al. 1991). Thus, the probability of encounter with the slick is related to the percentage of the time an animal spends on the water or shoreline surface, including any diel or oil avoidance behavior. Birds that are found in high densities are at risk for large impacts because a small amount of oil can affect many individuals. Similarly, colonial nesters are at greater risk because the birds congregate in high densities during the breeding season.

Diving pelagic seabirds (alcids), diving coastal birds (pelicans, loons, grebes, cormorants, boobies), and waterfowl (diving ducks, dabbling ducks, brant) are all at high risk for physical oiling (Huguenin et al. 1996). These groups are at high risk because they are frequently in contact with the surface due to their diving feeding behaviors. Alcids may be the most vulnerable group because they spend additional time floating in offshore waters, breed in large colonies, and reproduce irregularly. Diving coastal birds are at risk for similar reasons in nearshore waters. In addition to diving behavior, waterfowl are at risk for ingesting toxins because they consume intertidal invertebrates, which can bioaccumulate petrochemicals after a spill (Huguenin et al. 1996; Golet et al. 2002; Esler et al. 2002; Peterson et al. 2003).

Aerial seabirds (albatrosses, petrels, fulmars, shearwaters), shorebirds (sandpipers, plovers, turnstones, phalaropes), and aquatic raptors (eagles, osprey) are at moderate risk for oiling (Huguenin et al. 1996). Aerial seabirds spend much of their time flying above the water surface and therefore are not oiled in large numbers in oil spills. Additionally, this group includes species known to avoid oil, such as fulmars (Lorentsen and Anker-Nilssen 1993). Shorebirds and raptors are not at high risk for physical oiling at sea because they do not spend a lot of time in the water. However, these groups can be oiled when the spill reaches the coastline. Foraging activities along oiled shoreline increase the probability of oiling and once oiled the birds can transfer the oil to their nests, eggs, and offspring (Bowman et al. 1993). Both groups are also at risk of ingesting oil while feeding in fouled areas or by consuming contaminated prey. A model developed to investigate bioaccumulation of toxins in Santa Catalina bald eagles found most of the contaminants were consumed through sea lion carrion, but a significant portion was also consumed via fish resources (Glaser and Connolly 2002). Scavenging behavior in bald eagles was observed after the *Exxon Valdez* spill in Alaska. The eagles would scavenge other birds already disabled by the oil, consuming the oil in the process (Bowman et al. 1993). This resulted in over a 10 percent loss to the Alaskan bald eagle population; it was also reported that 66 percent of eggs had been contaminated by hydrocarbons (Bowman et al. 1993). Reproduction potential returned to near normal levels two years after the spill and the population was projected to return to pre-spill levels four years after the incident (Bowman et al. 1993).

Wading birds (herons, egrets, rails), gulls, and terns are the least sensitive groups. Wading birds are at a lower risk for physical oiling because they walk through shallow water instead of sitting on it. However, these species are still at risk for ingestion while cleaning themselves and potentially transferring oil to their nests, eggs, and offspring. Coastal oiling can also reduce prey availability and force populations farther inland or result in starvation (Maccarone and Brzorad 1995). Gulls are adaptable and opportunistic, and can avoid oil. However, this is uncommon. Studies have shown that while birds may sometimes try to avoid oil once they have experienced it, for the most part animals respond to overriding desires of obtaining food or other behaviors such that avoidance is negligible (Varoujean et al. 1983).

23.5 AIR EMISSIONS AND HYDROGEN SULFIDE

Inhalation of vapor is a concern for birds because they sustain a high breathing rate while in flight. Volatile hydrocarbons in petroleum are of concern to human health and can occur in concentrations above human health standards in areas affected by freshly spilled unweathered oil

(NRC 1985; NRC 2003). Therefore, this pathway is a concern for birds in the area where fresh unweathered oil is on the water surface.

Hydrogen sulfide (H₂S) is a toxic gas that can be detected by humans at very low concentrations (Collins and Lewis 2000). Higher concentrations can damage the nervous system and be fatal. H₂S is produced naturally during the decay of organic material and is found in petroleum. California air quality standards require that hydrogen sulfide remain below 0.03 ppm as a 1-hour average (Collins and Lewis 2000). Seabirds are at risk for inhalation of hydrogen sulfide because they sustain a high breathing rate while in flight. While the concentration at which seabirds are affected by hydrogen sulfide is not documented, the human guidelines are set conservatively and therefore acute exposures to concentrations below the human health standards are not likely to adversely affect these animals. Atmospheric H₂S concentrations are not known to exceed human health standards after oil spills (NRC 1985).

23.6 THREATENED AND ENDANGERED SPECIES

Species of special concern, including those on State and Federal threatened and endangered species lists, are generally more vulnerable to impacts of any sort. Characteristics that result in the listing of these species, including low population numbers, poor reproductive success, limited habitat, small home ranges, and low genetic diversity, make them susceptible to disturbances in their environment. As a result, threatened and endangered species are more likely to be negatively impacted by oil and gas development than nonlisted species. Of the four bird species discussed in the resources section none are at an increased risk of disturbance due to installation, operation or removal activities as their habitat is protected by California and the United States to ensure no negative impacts to the species (USDOJ, USFWS 2007). The highest risk for these animals occurs in the event of an oil spill. The light-footed clapper rail and the California least tern will be impacted only if the oil reaches shore where they nest and feed. The California brown pelican and Xantus' murrelet are at higher risk because these species feed at sea and therefore have the potential to come in contact with any spill, even if does not reach shore. Additionally, these species may be attracted to oil rigs as food resources can be concentrated in these areas.

23.7 SUMMARY AND DATA GAPS

Avian resources are some of the most sensitive to the effects of oil in their environment. Due to their particular mechanisms for buoyancy and thermal regulation, they are at high risk even in situations where only a small amount of oil is present. Assessment of impacts to this group is typically extensive including continued monitoring in heavily impacted areas such as Prince William Sound (Peterson et al. 2003).

Avian mortality after oil spills continues to be difficult to quantify accurately because of the high motility of birds and the multiple pathways by which they are affected by oil exposure. Accurate impact assessments are necessary to quantify loss to ecosystems, and models have offered some assistance with this problem. However, because models are based on empirical data from historical spills, mortality estimates may still not be accurate for the situation at hand.

Assessments of the impacts of construction noise on birds are often not performed for environmental impact statements for oil and gas development. However, adverse impacts may occur because birds are assumed to vacate an area of high noise; thus, this is an important topic in sensitive areas such as feeding and nesting sites. These areas are integral in the breeding success of bird species and need to be considered. Furthermore, many sea birds spend time diving underwater. Sound travels much differently in the aqueous environment and the effects of sound on mammals and fish are of concern and so continue to be studied. These studies should also extend to birds that spend time underwater and therefore may be affected by increased sound.

23.8 LIST OF REFERENCES CITED—BIRDS

- Anderson, D.W., F. Gress and D.M. Fry. 1996. Survival and dispersal of oiled Brown pelicans after rehabilitation and release. *Marine Pollution Bulletin* 32(10):711-718.
- Anderson, D.W., S.H. Newman, P.R. Kelly, S.K. Herzog and K.P. Lewis. 2000. An experimental soft-release of oil-spill rehabilitated American coots (*Fulica americana*): I. lingering effects on survival, condition and behavior. *Environmental Pollution* 107:285-294.
- Bourne, W.R.P., J.D. Parrack and G.R. Potts. 1967. Birds killed in the *Torrey Canyon* disaster. *Nature* 215:1123-1125.
- Bowman T.D., P.F.Schempf and J.A. Bernatowicz. 1993. Effects of the *Exxon Valdez* oil spill on Bald eagles. Anchorage (AK): U.S. Fish and Wildlife Service, Exxon Valdez oil spill state/federal natural resource damage assessment study. Bird Study 4 Final Report. 141 pp.
- Briggs, K.T., M.E. Gershwin and D.W. Anderson. 1997. Consequences of petrochemical ingestions and stress on the immune system of seabirds. *ICES Journal of Marine Science* 54:718-725.
- Burger, A.E. 1993. Estimating the mortality of seabirds following oil spills: Effects of spill volume. *Marine Pollution Bulletin* 26(3):140-143.
- Carter, H.R. 2003. Oil and California's seabirds: An overview. *Marine Ornithology* 31:1-7.
- Carter, H.R., V.A. Lee, G.W. Page, M.W. Parker, R.G. Ford, G. Swartzman, S.W. Kress, B.R. Siskin, S.W. Singer and D.M. Fry. 2003. The 1986 Apex Houston oil spill in central California: Seabird injury assessments and litigation process. *Marine Ornithology* 31(1):9-19.
- Carter, H.R. and G.W. Page. 1989. Central California Oil spill Contingency Plan, Assessment of Numbers and Species Composition of Dead beached Birds. U.S. Dept. of Commerce, National Atmospheric and Oceanic Administration, NOAA Technical Memorandum NOSMEMD 25.

- Chapman, B.R. 1981. Effects of the *Ixtoc I* oil spill on Texas shorebird populations. In: Proceedings of the 1981 Oil Spill Conference, Atlanta, GA. Washington, DC: American Petroleum Institute. Pp. 461-465.
- Clark, R.B. 1984. Impact of oil pollution on seabirds. *Environmental Pollution (Series A)* 33:1-22.
- Collins, J. and D. Lewis. 2000. Hydrogen sulfide: Evaluation of current California air quality standards with respect to protection of children. California Air Resources Board, California Office of Environmental Health Hazard Assessment, 25 pp.
- Croxall, J.P. 1977. The effects of oil on seabirds. *Rapport Procès-Verbal Reunion Conseil International pour L'Exploration de la Mer* 171: 191-195.
- Derraik, J.G.B. 2002. The pollution of the marine environment by plastic debris: A review. *Marine Pollution Bulletin* 44(9):842-852.
- Esler, D., T.D. Bowman, K.A. Trust, B.E. Ballachey, T.A. Dean, S.C. Jewett and C.E. O'Clair. 2002. Harlequin duck population recovery following the "Exxon Valdez" oil spill: Progress, process and constraints. *Marine Ecology Progress Series* 241:271-286.
- Ford, R.G. 1985. A risk analysis model for marine mammals and seabirds: A Southern California Bight scenario. Report to U.S. Dept. of the Interior, Minerals Management Service, Pacific OCS Region, Los Angeles, CA. OCS Study 85-0104. 236 pp.
- Ford, R.G. 1987. Estimating mortality of seabirds from oil spills. In: Proceedings of 1987 Oil Spill Conference. Washington, DC: American Petroleum Institute. Pp. 547-551.
- Ford, R.G., M.L. Bonnell, D.H. Varoujean, G.W. Page, H.R. Carter, B.E. Sharp, D. Heinemann and J.L. Casey. 1996. Total direct mortality of seabirds from the *Exxon Valdez* oil spill. In: Proceedings of the Exxon Valdez Oil Spill Symposium. American Fisheries Society Symposium 18. Bethesda, MD: American Fisheries Society. Pp. 684-711.
- Ford, R.G., N.A. Storm and J.L. Casey. 2006. Final report: Acute seabird mortality resulting from the *S.S. Luckenbach* and associated mystery oil spills, 1990-2003. California Dept. of Fish and Game, Office of Spill Prevention and Response. 46 pp.
- Ford, R.G., J.A. Wiens, D. Heinemann and G.L. Hunt. 1982. Modelling the sensitivity of colonially breeding marine birds to oil spills: Guillemot and Kittiwake populations on the Pribilof Islands, Bering Sea. *Journal of Applied Ecology* 19:1-31.
- Fraser, G.S., J. Russell and W.M. von Zharen. 2006. Produced water from offshore oil and gas installations on the grand banks, Newfoundland and Labrador: are the potential effects to seabirds sufficiently known? *Marine Ornithology* 34:147-156.
- French-McCay, D. 2009. State-of-the-art and research needs for oil spill impact assessment modeling. In: Proceedings of the 32nd Arctic and Marine Oil Spill Program (AMOP)

- Technical Seminar on Environmental Contamination and Response, Vancouver, BC, Canada. Emergencies Science Division, Environment Canada, Ottawa, ON, Canada: in press.
- French-McCay, D. and J.J. Rowe. 2004. Evaluation of bird impacts in historical oil spill cases using the SIMAP oil spill model. In: Proceedings of the 27th Arctic and Marine Oil Spill Program (AMOP) Technical Seminar. Emergencies Science Division, Environment Canada, Ottawa, ON, Canada. Pp. 421-452.
- Fry, D.M. 1987. Seabird oil toxicity study. Final report to Minerals Management Service, U.S. Dept. of the Interior, Washington, D.C. Submitted by Nero and Associates, Inc., Portland, OR.
- Gauthreaux, S.A. and C.G. Belser. 2006. Effects of artificial night lighting on migrating birds. In: Rich, C. and T. Longcore, eds. Ecological consequences of artificial night lighting. Washington, DC: Island Press. Pp. 67–93.
- Glaser, D. and J.P. Connolly. 2002. A model of p,p0-DDE and total PCB bioaccumulation in birds from the Southern California Bight. *Continental Shelf Research* 22:1079-1100.
- Golet, G.H., P.E. Seiser, A.D. McGuire, D.D. Roby, J.B. Fischer, K.J. Kuletz, D.B. Irons, T.A. Dean, S.C. Jewett and S.H. Newman. 2002. Long-term direct and indirect effects of the “Exxon Valdez” oil spill on pigeon guillemots in Prince William Sound, Alaska. *Marine Ecology Progress Series* 241:287-304.
- Hampton, S., P.R. Kelly and H.R. Carter. 2003. Tank vessel operations, seabirds and chronic oil pollution in California. *Marine Ornithology* 31:29-34.
- Huguenin, M.T., D.H. Haury, J.C. Weiss, D. Helton, C.A. Manen, E. Reinharz and J. Michel. 1996. Injury assessment: Guidance document for natural resource damage assessment under the oil pollution act of 1990. National Oceanic and Atmospheric Administration, Damage Assessment and Restoration Program, Silver Spring, MD.
- Hunt, G.L., Jr. 1985. Offshore oil development and seabirds: The present status of knowledge and long-term research needs. In: D. Boesch and N. Rabalais, eds. The long-term effects of offshore oil and gas development: An assessment and a research strategy. Prepared for NOAA, National Marine Pollution Program Office by Louisiana Universities Marine Consortium (LUMCON).
- Jenssen, B.M. 1994. Review article: Effects of oil pollution, chemically treated oil, and cleaning on the thermal balance of birds. *Environmental Pollution* 86:207-215.
- Jenssen, B.M. and M. Ekker. 1991a. Dose-dependent effects of plumage-oiling on thermoregulation of common eiders *Somateria mollissima* residing in water. *Polar Research* 10:579-84.

- Jenssen, B.M. and M. Ekker. 1991b. Effects of plumage contamination with crude oil dispersant mixtures on thermoregulation in common eiders and mallards. *Archives of Environmental Contamination and Toxicology* 20:398-403.
- Longcore, T. and C. Rich. 2004. Ecological light pollution. *Frontiers in Ecology and the Environment* 2(4):191-198.
- Lorentsen, S.-H. and T. Anker-Nilssen. 1993. Behavior and oil vulnerability of fulmars *Fulmarus glacialis* during an oil spill experiment in the Norwegian Sea. *Marine Pollution Bulletin* 26(3):144-146.
- Maccarone, A.D. and J.N. Brzorad. 1995. Effects of an oil spill on the prey populations and foraging behavior of breeding wading birds. *Wetlands* 15(4):397-407.
- McCrary, M.D., D.E. Panzer and M.O. Pierson. 2003. Oil and gas operations offshore California: Status, risks, and safety. *Marine Ornithology* 31:43-49.
- National Research Council (NRC). 1985. Oil and sea, inputs fates and effects. Washington, DC: National Academy Press. 601 pp.
- National Research Council (NRC). 2003. Oil in the sea III: Inputs, fates and effects. Washington, DC: National Academy Press. 446 pp.
- Ohlendorf, H.M., R.W. Risebrough and K. Vermeer. 1978. Exposure of marine birds to environmental pollutants. U.S. Fish and Wildlife Service Wildlife Research Report 9. 40 pp.
- Page, G.W., H.R. Carter and R.G. Ford. 1990. Numbers of seabirds killed or debilitated in the 1986 *Apex Houston* Oil Spill in Central California. *Studies in Avian Biology* 14:164-174.
- Peakall, D.B., P.G. Wells and D. Mackay. 1985. A hazard assessment of chemically dispersed oil spills and seabirds-A novel approach. In: Proceedings of the 8th Technical Semi-Annual Arctic Marine Oil Spill Program. Environmental Canada, Edmonton, AB. Pp. 78- 90.
- Peterson, C.H., S.D. Rice, J.W. Short, D. Esler, J.L. Bodkin, B.E. Ballachey and D.B. Irons. 2003. Long-term ecosystem response to the Exxon Valdez oil spill. *Science* 302:2082-2086.
- Poot, H., B.J. Ens, H. de Vries, M.A.H. Donners, M.R. Wernand and J.M. Marquenie. 2008. Green light for nocturnally migrating birds. *Ecology and Society* 13(2):47.
- Rojek, N.A., M.W. Parker, H.R. Carter and G.J. McChesney. 2007. Aircraft and vessel disturbances to common murre *Uria Aalge* breeding colonies in central California, 1997-1999. *Marine Ornithology* 35:61-69.
- Samuels, W.B. and K.J. Lanfear. 1982. Simulations of seabird damage and recovery from oil spills in the Northern Gulf of Alaska. *Journal of Environmental Management* 15:169-182.

- Seip, K.L., E. Sandersen, F. Mehlum and J. Ryssdel. 1991. Damages to seabirds from oil spills: Comparing simulation results and vulnerability indexes. *Ecological Modelling* 53:39-59.
- Speich, S.M., D.A. Manuwal and T.R. Wahl. 1991. The bird/habitat oil index: A habitat vulnerability index based on avian utilization. *Wildlife Society Bulletin* 19:216-221.
- Stephenson, R. 1997. Effects of oil and other surface-active organic pollutants on aquatic birds. *Environmental Conservation* 24(2):121-129.
- Thomsen, F., K. Ludemann, R. Kafemann and W. Piper. 2006. Effects of offshore wind farm noise on marine mammals and fish. Biola, Hamburg, Germany, on behalf of COWRIE Ltd. Internet access: <http://www.offshorewind.co.uk>. Accessed May 2009.
- U.S. Dept. of the Interior, Minerals Management Service (MMS). 2001. Delineation drilling activities in Federal waters offshore Santa Barbara County, California, draft environmental impact statement. MMS OCS EIS/EA 2001-046. U.S. Dept. of the Interior, Minerals Management Service, Pacific OCS Region, Camarillo, CA.
- U.S. Dept. of the Interior, Minerals Management Service (MMS). 2007. Gulf of Mexico OCS oil and gas lease sales: 2007-2012; Western Planning Area Sales 204, 207, 210, 215, and 218; Central Planning Area Sales 205, 206, 208, 213, 216, and 222—Final environmental impact statement. Vols. 1 and 2. U.S. Dept. of the Interior, Minerals Management Service, Gulf of Mexico OCS Region, New Orleans, LA. OCS EIS/EA MMS 2007-018.
- U.S. Dept. of the Interior, U.S. Fish and Wildlife Service (USFWS). 2007. Recovery Plan for the Pacific Coast Population of Western Snowy Plover (*Charadrius alexandrinus nivosus*). FWS Region. Pp. xiv + 751.
- Varoujean, D.H., D.M. Baltz, B. Allen, D. Power, D.A. Schroeder and K.M. Kempner. 1983. Seabird-oil spill behavior study: Vol. 1: Executive summary, Vol 2: Technical report, Vol. 3: Appendices. Final report to U.S. Dept. of the Interior, Minerals Management Service, Reston, VA, by Nero and Associates, Inc., Portland, OR. MMS-QN-TE-83-007, NTIS #PB84-17930. 365 pp.
- Viada, S.T., R.M. Hammer, R. Racca, D. Hannay, M.J. Thompson, B.J. Balcom and N.W. Phillips. 2008. Review of potential impacts to sea turtles from underwater explosive removal of offshore structures. *Environmental Impact Assessment Review* 28:267-285.
- Wiese, F.K., W.A. Montevicchi, G.K. Davoren, F. Huettmann, A.W. Diamond and J. Linke. 2001. Seabirds at risk around offshore oil platforms in the north-west Atlantic. *Marine Pollution Bulletin* 42(12):1285-1290.
- Wiese, F.K. and G.J. Robertson. 2004. Assessing seabird mortality from chronic oil discharges at sea. *Journal of Wildlife Management* 68(3):627-638.

24. MARINE MAMMALS

Oil and gas development activities, including initial exploration, construction, extraction, transport, possible spills, and decommissioning may affect marine mammals in several ways. Impacts are grouped into: (1) impacts of noise on marine mammals, including seismic surveys, construction (including drilling), vessel traffic and transport, and explosive impacts during the removal of structures; (2) impacts due to contact with oil (including ingestion) from spills or seepage; and (3) impacts of possible collisions with ships and other infrastructure due to construction, normal operations, and transport.

24.1 IMPACTS OF NOISE

Underwater noise can have physical and behavioral effects on marine mammals, such as hearing loss, discomfort, injury, masking of important sounds, and behavioral reactions such as fright, avoidance, or changes in communication or feeding behaviors (Hanson and Defran 1993; Richardson et al. 1995; Mccauley et al. 2000; Evans 2002; Finneran et al. 2002; Richardson 2002; Gordon et al. 2004; Nowacek et al. 2007; Southall et al. 2007; Tyack et al. 2008). Sources of noise during oil and gas development include: seismic surveys, ship traffic, construction including pile driving, helicopter traffic, explosions during demolition or removal, and normal pipeline and operations noise.

Noise impacts focused on below are those that involve a specific type of sound source and it affects marine mammal behavior. Some very loud sources of noise, primarily from seismic surveys, do have the potential to cause physical injury, however, these would likely only affect animals at very close range to the source. Physical injury from exposure to noise can include: (1) loss of hearing through temporary and permanent threshold shift (TTS and PTS), (2) damage to hearing organs, (3) damage to other body tissues, and (4) physical impacts of stress from exposure to sound (Evans 2003). Threshold levels for physical impacts have been developed for various species groups (Southall et al. 2007).

Cetaceans vocalize and detect sounds for communication, orientation, predator avoidance, and feeding (Tyack et al. 2008). Large baleen whales generate low-frequency sounds that travel long distances; in some cases, these sounds may travel across ocean basins (Stafford et al. 1998). Most baleen whales produce sounds in the frequency of 10 Hz to 10 kHz (Richardson et al. 1995). Toothed cetaceans produce short, ultrasonic clicks for navigation and echolocation from 1 to 150 Hz (Richardson et al. 1995), delphinid toothed cetaceans also produce frequency-modulated whistles, thought to be used for communication (Tyack et al. 2008). Pinniped communication occurs in the frequency range of 50 to 60 Hz (Richardson et al. 1995).

Researchers have conducted playback experiments on gray whales to examine short-term responses to a wide range of industrial noises (Malme et al. 1983; Malme et al. 1985; Malme et al. 1986; Dahlheim 1987; Malme et al. 1987; Richardson et al. 1995; Moore and Clarke 2002). Responses included changes in swimming speed and movement away from the noise, abrupt behavioral changes from feeding to avoidance, changes in calling rates, and changes in surface behavior. Malme et al. (1986) reported there would be a 0.5 probability of avoidance by gray

whales when received sound levels exceeded about 120 dB for continuous noise or 170 dB for intermittent noise. When various forms of potential disturbances were ranked, gray whales had a high probability of impact by noise from oil and gas development, especially from large tankers, dredges, and airgun arrays (Malme et al. 1986; Richardson et al. 1995; Moore and Clarke 2002).

24.1.1 Seismic Surveys

The effects of the intense noise produced by marine seismic surveys on marine mammals—known for their acoustic sensitivity—is an issue of great concern (Richardson et al. 1995; Gordon et al. 2004; Nowacek et al. 2007). The primary biological consequences of airgun noise on marine mammals are the physical/physiological effects and the disruptive impact of hazard avoidance on activities such as feeding, orientation, migration, and social behaviors (Richardson et al. 1995; Wartzok et al. 2003; Gordon et al. 2004).

While the hearing sensitivity of most baleen whales is unknown, the presumption is that the highest sensitivity would be to frequencies similar to their own vocalizations. Most energy produced by a seismic airgun ranges from 20 to 160 Hz; bowhead whales vocalize primarily in the range of 25 to 400 Hz. Blue and fin whales produce sounds primarily at 10 to 60 Hz (Evans and Nice 1996; Evans 2002).

Some marine mammals are more susceptible to noise from airguns than others ([Tables 24.1](#) and [24.2](#)). Factors that make some species vulnerable include (Evans 2002):

- Species that vocalize using low-frequency sounds for communication, navigation, and locating prey; these sounds potentially travel hundreds of miles.
- Whales with presumed hearing sensitivities that most directly overlap with airgun sound frequencies (20-160 Hz)
- Endangered species, in particular, the North Pacific right whale (of which few exist) so that little is known about their abundance or distribution (Brownell et al. 2001).
- Deep-diving species. In deep waters, sound may be more intense in specific water layers (e.g., the SOFAR channel) and transmitted for long distances (Evans 2002).
- Species with migration routes or feeding areas that overlap with areas planned for seismic exploration.

Table 24.1.

Cetacean Species With Potential Susceptibility to Seismic Surveys in the Southern Study Area

Factor	Blue whale	Fin whale	Sei whale	Brydes whale	Minke whale	Hump-back whale	Right whale	Gray whale	Sperm whale	Beaked whales	Killer whale	Harbor porpoise
Species that emit low-frequency sounds that travel long distances	x	x	x	x	x	x						
Species for which hearing frequency overlaps with airgun frequencies	x	x	x	x	x	x						
Endangered/Threatened species (ESA)	x	x	x			x	x		x		x	
Deep-diving species									x	x		
Species with migration routes or feeding areas in areas of planned exploration						x		x				x

Table 24.2.

Potential Susceptibility of Pinniped Species and Sea Otters to Seismic Surveys in the Southern Study Area

Factor	Harbor seal	Calif sea lion	Guad. fur seal	Steller sea lion	Elephant seal	N. fur seal	Sea otter
Species that emit low-frequency sounds that travel long distances							
Species for which hearing frequency overlaps with airgun frequencies	x				x		
Endangered/Threatened species (ESA)			x	x			x
Deep-diving species					x		
Species with migration routes or feeding areas in areas of planned exploration	x	x		x		x	x

Most research on the impacts of airgun noise has focused on just two species (Richardson et al. 1995). While some variation occurs in the behavioral effects at different intensities, bottom types, and depth and distance from the noise, it is clear that marine mammals do react to airgun noise. In many cases, the animals' behavior (i.e., migration, feeding) is interrupted and they move away from the area of seismic activity. After the airgun noise has ceased, animals tend to return to the area. (Gordon et al. 2004) summarized observations of behavior change in marine mammals in response to airguns.

While no bowhead whales live in the Northern Study Area, this species is probably the best studied in terms of seismic impacts due to the extensive amount of oil and gas exploration that has occurred in the Arctic (Reeves et al. 1984; Richardson et al. 1985; Ljungblad et al. 1988; Richardson et al. 1995; Richardson and Würsig 1997; Richardson 2002). Bowhead whales are relevant since they are closely related to North Pacific right whales. While it is not possible to study the impacts on this rare species directly, the effects on bowhead whales should be closely considered when evaluating impacts on the North Pacific right whales. Long-range avoidance was observed for migrating bowheads, avoiding airgun noise to more than 20 km where received levels were 120 to 130 dB re: 1 μ Pa rms (Richardson et al. 1999). Behavioral changes in blow rates and dive times were also observed (Richardson et al. 1995).

The other species that has been thoroughly studied for airgun impacts is the gray whale (Malme et al. 1983; Malme et al. 1986; Malme et al. 1987; Moore and Clarke 2002; Weller et al. 2006a; Weller et al. 2006b). Controlled studies on gray whales migrating along the California coast showed that animals exposed to airgun noise slowed and moved away (received levels for avoidance by 10 percent, 50 percent and 90 percent of animals were 164, 170 and 190 dB re: 1 μ Pa rms (Malme et al. 1987; Gordon et al. 2004). Changes in distribution and acoustic responses occurred during playback experiments in San Ignacio Lagoon, Mexico, in 1985 (Dahlheim 1987; Schwarz 2002). Most whales abandoned the breeding lagoon, apparently in response to the noise, though the whales returned and regularly inhabited this area in subsequent years (Jones et al. 1994). Studies of western gray whales off Sakhalin Island, Russia, found similar results, with animals abandoning feeding areas during seismic activity (Weller et al. 2006a; Weller et al. 2006b). These studies suggest that disruption of feeding behavior could have a major impact on this species (Weller et al. 2006b).

Researchers have also evaluated the impact of seismic activities on humpback whales (Malme et al. 1985; Mccauley et al. 2000; Au 2006), blue whales (McDonald et al. 1995), and sperm whales (Madsen et al. 2002; Madsen et al. 2006a; Miller et al. 2009). Very little research has been done on the impacts of airguns on seals (Richardson et al. 1995; Harris et al. 2001).

There is debate on whether a seismic survey was responsible for the death of two Cuvier's beak whales in the Gulf of California in 2002 (Taylor et al. 2004; Cox et al. 2006). This survey was conducted with a powerful airgun array on the RV *Maurice Ewing*, a vessel possibly associated with a stranding of beaked whales in the Galapagos Islands in 2000 (Gordon et al. 2004). The uncertainties surrounding the beaked whale deaths exemplify the lack of understanding on the possible damage from airgun impulses.

Generally, the deep-diving odontocetes, such as beaked whales, sperm whales, and pygmy and dwarf sperm whales, may suffer impacts to their hearing under some conditions during routine seismic surveys. For these species, the sound may prove more intense at particular water layers (i.e. SOFAR channel) and transmitted at long distances (Evans 2002). They may, on occasion, be swimming directly below an airgun array, exposing them to maximal airgun output (USDOI, MMS 2006). The potential for deleterious effects on these species is also higher because they spend less time at the surface; therefore, opportunities for the animals to become aware of the seismic vessel or for observers to note the animals' presence and impose additional mitigation measures are lessened.

24.1.2 Construction and Dredging

Noise and activities associated with the construction of offshore facilities and pipelines could disturb marine mammals in the area. Construction could disrupt normal behaviors (e.g., feeding, social interactions), mask calls from other animals, disrupt echolocation capabilities, and obscure sounds by predators (Richardson et al. 1995; USDOI, MMS 2006). Consequently, the animals may leave the construction area, either temporarily or permanently. In cases for which the specific habitat is not essential to the animal, the effects are short term and sublethal. When animals have a strong fidelity to the habitat within the construction area (i.e., prime habitat for mating, feeding, calving), however, the impacts would prove severe.

Dredges make significant underwater noise during construction (Richardson et al. 1995). One experimental study studied the impacts of dredging on bowhead whales. Animals exposed to the strongest sounds (122 to 131 dB or 21 to 30 dB above ambient levels) showed obvious avoidance, including the cessation of feeding as well as moving away from the area (≥ 2 km away) (Richardson et al. 1990; Richardson et al. 1995). Questions remain about whether some bowhead whales habituated to the sound of dredging during oil and gas development in the Beaufort Sea, although overall numbers of whales dropped after the onset of intensive drilling (Richardson et al. 1995). During a project with constant dredging to keep a shipping channel open in a Baja lagoon, gray whales abandoned the lagoon during the years that this activity was in progress (Bryant et al. 1984; Thomson and Johnson 1996).

Pile-driving effects have been documented recently in the installation of wind-energy facilities in northern Europe. Visual surveys noted changes in harbor porpoise behavior up to 15 km from the construction site during the pile driving (Tougaard et al. 2003; Madsen et al. 2006b; Teilmann et al. 2006a; Teilmann et al. 2006b; Tougaard et al. 2006). Also, changes in echolocation behavior were dramatic during pile driving (Henriksen et al. 2003; Carstensen et al. 2006; Tougaard et al. 2006). Researchers also documented changes in abundance and distribution for seals; fewer seals were observed at haul-out sites and were absent from the surrounding waters during the pile-driving phase of construction (Teilmann et al. 2004; Teilmann et al. 2006b; Tougaard et al. 2006). Changes in activity levels returned to normal after the pile driving ceased (Tougaard et al. 2003; Madsen et al. 2006b; Tougaard et al. 2006). When impact zones are modeled for pile-driving operations, these sounds are audible to harbor seals and harbor porpoises at long distances. Calculated ranges extend more than 100 km, and perhaps up to 1,000 km, using the highest reported sound pressure levels and lowest measured transmission loss (Madsen et al. 2006b). At these distances, marine mammals in deeper waters,

including those susceptible to low-frequency sounds such as beaked whales and baleen whales, would be affected (Mccauley et al. 2000; Richardson 2002; Gordon et al. 2004; Barlow and Gisiner 2006; Cox et al. 2006; Macleod and D'amico 2006; Weller et al. 2006a; Weller et al. 2006b).

For the most part, other construction activities, including the operation of small artificial islands, have not demonstrated major impacts on Arctic species (Richardson et al. 1995). Some short-term displacement of ringed and bearded seals occurred within a few kilometers of the area, but, overall densities of ringed seals were higher in the region. Richardson et al. (1995) dismiss the impacts of artificial islands as insignificant.

24.1.3 Drilling and Operation

Noise produced during drilling and operation occurs at relatively low frequency, typically between 4.5 and 30 Hz (Richardson et al. 1995). Potential effects on marine mammals include disturbance, such as changes in behavior and displacement, and the masking of calls from conspecifics or other natural sounds (e.g., from surf, predators). The sounds used by odontocetes are frequencies that tend to be higher than those produced by offshore drilling and operation activities; these species, therefore, may not be sensitive to or affected by these sounds. Researchers should focus some attention on sperm whales and beaked whales. These species have good low-frequency hearing and could be affected by drilling and production noise. Effects would be similar to those for construction activities—primarily behavioral disruption and avoidance or displacement from the region surrounding the operating facility. Because the mysticetes (which include the filter-feeding whales) possess good hearing sensitivity and vocalize at low frequencies ([as described in Section 24.1](#)) these species may be affected by drilling and production noise.

While a few controlled playback studies have examined the impact of oil drilling on baleen whales (bowhead, gray, and humpback), little is known about other species and impacts have not been studied comprehensively (Richardson et al. 1995). In general, these studies demonstrated that cetaceans avoid operation activities including dredging, drilling, and production (Richardson et al. 1995). For gray whales migrating off California, studies have demonstrated behavioral reactions and avoidance of simulated sounds of drillships, semi-submersibles, drilling, and production platforms (Malme et al. 1983; Richardson et al. 1995). Gray whales remain of particular concern because of their narrow migration route. In winter, the entire population moves through the Southern Study Area during its southbound migration, again moving through the area in the spring traveling northbound (Rice 1965; Moore and Clarke 2002; Mate and Urbán-Ramirez 2003). Gray whales have migrated past the oil platforms in the Santa Barbara Channel for decades and appear to have habituated to, or become tolerant of, the noise generated by these facilities, even though mysticetes up to 5 km away can hear these sounds (Moore and Clarke 2002).

Very little research has taken place on the impacts on toothed whales or pinnipeds (Richardson et al. 1995). Anecdotal reports exist of animals in the vicinity of oil drillsites (Richardson et al. 1995). Some data support seal tolerance to drillship noise, although one study found that ringed

seals densities were lower close to artificial islands during drilling operations (Frost et al. 1988). Ringed seals are closely related to harbor seals and impacts would likely be similar.

24.1.4 Vessel Traffic and Transport

Several studies have reported short-term behavioral effects of vessel traffic on marine mammals (Au and Green 2000; Nowacek et al. 2001; Erbe 2002; Moore and Clarke 2002; Williams et al. 2002; Evans 2003; Buckstaff 2004; Foote et al. 2004; 2008; Jensen et al. 2008; Holt et al. 2009). Harbor porpoise are notoriously wary of boats and increased vessel traffic may be the cause of their disappearances from areas where they were once common, including Puget Sound, San Francisco Bay, the Baltic Sea, and the Wadden Sea (Leatherwood and Reeves 1983; Osborne et al. 1988). Low-frequency noise (5-500 Hz) from commercial shipping is ubiquitous in the world's oceans (Hildebrand 2005).

While little is known about the long-term impacts of vessel traffic on marine mammals, in two cases researchers have speculated that increased vessel traffic may have affected long-term gray whale distribution. Between 1975 and 1978, aerial surveys showed that about 60 percent of gray whales were using migration routes in Southern California farther offshore than the coast routes they used previously (Dohl and Guess 1979). Between 1964 and 1983, seismic activity in this region was substantial (Malme et al. 1983), although many suggest that increases in noise and vessel traffic in this region was the cause of this migratory shift (Rice 1965; Mate and Urbán-Ramirez 2003). The second case focused on gray whales feeding in Clayoquot Sound off Vancouver Island. Researchers found a sequential increase in gray whale foraging locations away from the major whale-watching port of Tofino over a three-year period (Duffus 1996). While determining if the whale-watching vessels contributed to or caused this shift in gray whale distribution was not possible, Duffus suggests a risk-averse conservative management approach for regulating vessel traffic in gray whale feeding areas. Long-term displacement has also been attributed to increased vessel traffic noise for humpback whales in Hawaii and southeastern Alaska (Richardson et al. 1995).

In addition to changes in distribution during this study, gray whales also altered their vocalizations in response to outboard engine and oil-drilling sounds. Four different measures of their calls were significantly higher than those measured under experimental conditions (Dahlheim 1987). Whales adapted their calls in response to the noise, essentially “shouting” and calling more frequently to counteract the higher noise levels.

The effects of helicopter noise have been examined for a few cetacean species (Richardson et al. 1995; Patenaude et al. 2002; Nowacek et al. 2007). Bowhead whales reacted to helicopter approaches that had altitudes of 150 m or less and lateral distances of 250 m or less (Patenaude et al. 2002).

24.1.5 Explosions During Construction or Demolition

The impact of explosives can prove quite devastating to marine mammals given their potential to induce blast injury and acoustic trauma (Ketten 1995; Richardson et al. 1995; Todd et al. 1996; Finneran et al. 2000). Shock waves produced by explosions can cause severe injury and death to animals, although threshold levels are not well established (Richardson et al. 1995).

24.2 IMPACTS OF EXPOSURE TO OIL

Direct exposure by marine mammals to oil occurs in several ways including major oil spills during drilling or transport and chronic low-level discharges of oil products. Exposure to oil could affect marine mammals in many ways depending on the species, the location, nature, and magnitude of the spill, and the environmental conditions involved. Exposure of marine mammals to oil can occur by direct contact, inhalation, and ingestion (including consumption of oiled prey). The health effects of such exposure have been the subject of considerable research and reviews (Geraci and St. Albin 1990).

Inhalation of toxic vapors from oil spills, especially in the early stages of a spill, may irritate or damage respiratory membranes, congest lungs, and cause pneumonia. Inhaled volatile hydrocarbons may be absorbed into the bloodstream and accumulate in the brain and liver, leading to neurological disorders and liver damage (Geraci and St. Albin 1990). Marine mammals would be most exposed to such toxic vapors just above the surface of an oil spill.

Marine mammals can ingest oil in several ways, including incidental consumption of floating or submerged oil or oil-contaminated prey (Geraci and St. Albin 1990). Spilled oil may also foul the baleen fibers of mysticete whales, temporarily impairing food-gathering efficiency or resulting in the ingestion of oil or oil-contaminated prey. Ingested oil can remain within the gastrointestinal tract and be absorbed into the bloodstream, potentially irritating and destroying epithelial cells in the stomach and intestine. Certain constituents of oil, such as aromatic hydrocarbons and polyaromatic hydrocarbons, are well-known carcinogens.

An accidental oil spill may result in the localized reduction, extirpation, or contamination of prey species. Invertebrate and vertebrate species may become contaminated and subsequently expose marine mammals that feed on these species. This situation occurred after the Prince William Sound oil spill and was extensively documented (Peterson et al. 2003). Because benthic organisms (such as crustaceans and mollusks) accumulate oil compounds more readily and at higher levels than pelagic biota, the potential for ingesting oil-contaminated prey is greatest for benthic-feeding marine mammals.

For cetaceans, direct contact with oil may irritate, inflame, or damage skin and sensitive tissues (such as eyes and other mucous membranes) (Geraci and St. Albin 1990). Prolonged contact to petroleum products may: reduce food intake elicit agitated behavior; alter blood parameters, respiration rates, and gas exchange; and depress nervous functions. Oil does not appear to adhere readily to or be absorbed through cetacean skin.

A primary concern for marine mammals relying on fur for insulation is the loss of this insulation from fouling of the fur by oil. Problems with fouling would be most acute for sea otters that rely heavily on fur for insulation, and, secondarily, for fur seals and sea lions that use both fur and blubber for insulation. Along the Southern California coast, sea otters and northern and Guadalupe fur seals are the most vulnerable to oil fouling of fur. These animals suffer risk of hypothermia as along with problems related to oil ingestion from attempting to groom and clean contaminated fur.

The detailed and long-term studies conducted in the wake of the 1989 Exxon Valdez oil spill represent one of the most thorough examinations of oil-spill consequences to the marine environment, including marine mammals (Loughlin 1994; Peterson and Holland-Bartels 2002; Peterson et al. 2003). Sea otters were certainly the most dramatic and immediate marine-mammal victims of the oil spill; approximately 2,650—about half the estimated population—died due to oil exposure (Garrott et al. 1993). Although the vulnerability of sea otters to oil was previously known due to their reliance on fur for insulation, sea otter mortality rates remained higher in oiled areas after the spill compared to before the spill and compared to unaffected areas. This mortality apparently resulted from continued chronic exposure to oil (Peterson et al. 2003). The long-term impacts of oil on the survival of Prince William Sound sea otters were most evident in otters that were alive during the spill, but also occurred to a lesser extent in those born after the spill in the area of the spill (Monson et al. 2000).

An estimated several hundred harbor seals also died from inhalation of oil fumes after the spill in Prince William Sound, although this number represented only a very small proportion of the population (Loughlin 1994). Post-spill counts of harbor seals continued to decline; however, numbers had dropped prior to the spill, which complicates the assessment of how the spill contributed to these declines (Frost et al. 1999). Declines in both resident and transient pods of killer whales also occurred after the spill, apparently from oil exposure (Loughlin 1994). While acute effects of the spill were notable for some species, some of the long-term ecosystem consequences may prove to have the longest-reaching impact (Peterson et al. 2003).

Oil-spill cleanup may also pose a risk to marine mammals. Cleanup can expose animals to chemicals used in oil-spill response, such as dispersants. Vessels involved in oil-spill response may also disturb the animals. While some of the chemicals used in such a response are less toxic than the oil itself, they still may pose a risk and information on the effects of these chemicals on marine mammals is often unknown or uncertain. The [section on ship strikes below](#) discusses the risk to marine mammals from vessels responding to oil spills.

24.3 IMPACTS OF COLLISIONS WITH VESSELS OR INFRASTRUCTURE

24.3.1 Ship Strikes

Ship strikes by large vessels are a significant cause of mortality in some marine mammals species (Laist et al. 2001; Moore and Clarke 2002; Vanderlaan and Taggart 2007; Douglas et al. 2008). While injuries are most common with smaller vessels traveling slower than 14 knots, most lethal collisions occur with faster ships that exceed 80 m in length (Laist et al. 2001). Commercial vessels in the Southern Study Area travel to and from large ports in Long Beach, Los Angeles, and San Diego. In the Pacific, reports of large whales hit and killed by ships include gray whales, fin whales, humpback whales, sperm whales, blue whales, sei whales, and Baird's beaked whales (Douglas et al. 2008).

24.3.2 Entanglement in Cables

Most types of oil and gas development require some use of cables and mooring lines to anchor structures, connect devices, and transmit power. While extensive literature on marine mammal interactions with these types of lines does not exist, entanglement in nets and buoy lines for crab

and lobster gear has constituted a major source of mortality in cetaceans and is a major concern worldwide. A scientific workshop on the ecological effects of wave energy development in the Pacific Northwest identified mooring and the attendant cables as the biggest ecological threat to cetaceans (Boehlert et al. 2008). The primary concern is that cetaceans might strike them or become entangled. Additionally, gray whales might perceive large numbers of moorings as a barrier, and the resulting response could disrupt migration. Thin or slack cables that could easily entangle animals pose the most serious risk.

In the Pacific, harbor porpoise, harbor seals, gray whales, and humpback whales are the primary marine mammals killed by entanglement (Baird et al. 2002; Moore and Clarke 2002; Douglas et al. 2008). Most of these cases involve entanglement in nets, but both gray and humpback whales also became entangled in single lines from crab pots. Both humpback and right whales in the North Atlantic have become entangled in pot gear, most commonly in the buoy line that extends from the gear to the surface and next most commonly in the ground line that connects the pots to each other or the anchor to a pot (Johnson et al. 2005).

Several strategies have been recommended to reduce possible entanglement, including limiting the number of lines, avoiding slack lines, and using acoustical pingers (Boehlert et al. 2008). Acoustic pingers dramatically reduce the entanglement rates of many eastern North Pacific cetaceans (Barlow and Cameron 2003), including beaked whales in offshore drift gillnets off California (Carreta et al. 2008) and harbor porpoises in coastal gillnets off Washington (Gearin et al. 2000).

24.4 SUMMARY OF DATA GAPS

Gaps in information for the Southern Study Area associated with the potential impacts of oil and gas development can be broken into two areas; gaps related to the status of marine mammals in the region; and those related to the potential impacts of oil and gas.

24.4.1 Biological Data Gaps

- **Site-specific marine mammal abundance.** Marine mammal populations continue to change rapidly as noted in some species accounts. BOEMRE-sponsored surveys took place in the 1970s and 1980s and provided important information that is now out-of-date. Current assessments of marine mammal abundance and trends used as the basis of the stock assessment reports on each species are based on several types of surveys and methodologies. The Southwest Fisheries Science Center (SWFSC) conducted periodic vessel line-transect surveys along the U.S. West Coast which are critical for gathering information on some of the widely dispersed and abundant cetaceans (Barlow and Forney 2007). For some endangered large cetaceans, mark-recapture of photo-identified humpback and blue whales serves as the best basis for estimates of abundance and trends (Calambokidis and Barlow 2004). For several other species, such as harbor porpoise and gray whales, specialized census techniques are used. Pinniped abundance is best determined from a census of hauled-out animals. Regardless of technique, up-to-date

assessments of population status are often not available for assessing the impacts of new activities and potential threats.

- **Lack of information on seasonal occurrence.** Most of the information on marine mammal occurrence and abundance from recent years comes primarily from summer and fall. While these seasons are ideal for surveys of abundance, improving information on the occurrence of marine mammals in other seasons remains important to assess the impact of activities such as oil and gas development that may take place at other times of year. Many marine mammals have strong seasonal migrations; even those that do not may have seasonal shifts in distribution (Douglas et al. In prep).
- **Data on species with greater vulnerability to oil and gas activities.** Data gaps exist on species most vulnerable to oil- and gas-related activities and may be the most critical for assessing impacts. Sea otters are among the most vulnerable species because of their reliance on fur for insulation; this species suffered long-term impacts after oil exposure in Prince William Sound (Peterson et al. 2003). Sea otters are considered a keystone species whose presence alters the environment and impacts other species. Blue and fin whales are vulnerable to ship strikes from vessel traffic off Southern California. Ship strikes of blue whales in fall 2007 in Southern California occurred at a level that exceeded the NMFS estimate of sustainable biological removal. Killer whales may have been one of the more severely impacted species in Prince William Sound by the Exxon Valdez oil spill, although this conclusion is clouded by the possible other factors impacting killer whales (Peterson et al. 2003).

24.4.2 Gaps in Research on Impacts

Much of the research on the impacts of oil and gas on marine mammals took place in the 1970s and 1980s (Geraci and St. Albin 1990). Many of the data gaps identified then still remain. Key remaining gaps include:

- **Data on long-term impacts of oil exposure.** As a result of the Exxon Valdez oil spill, researchers have extensively studied the impacts on marine mammals and conducted long-term follow-up studies (Peterson et al. 2003). While these studies have identified subtle, potentially long-term impacts, some of results remain ambiguous and controversial.
- **Data on the impacts of underwater sound.** Some oil and gas development activities create loud underwater sounds, especially seismic surveys during exploration and underwater explosions during demolition of old platforms. While knowledge of underwater sound and the vulnerability of marine mammals to noise have increased dramatically, a great deal of uncertainty and controversy still exist. The U.S. Navy has dramatically increased funding for studies of the impacts on Navy sonar. The oil and gas industry, through programs such as the Joint Industry Program, have also funded research on marine mammal impacts. Several important data gaps related to acoustics and

marine mammals still exist ((Boehlert et al. 2008) including: (1) identifying the ambient sounds near a potential wave energy facility, and (2) determining the hearing sensitivity of cetacean and pinnipeds and how they respond to noise generated by a wave energy buoy or buoy array.

- **Improved determination of ship strike threat and ways to reduce their occurrence.** Ship strikes are a major threat to large whales, especially blue and fin whales, in areas such as the Southern California Bight where dense feeding areas occur near some of the busiest shipping lanes in the world. Extensive research and efforts to protect right whales in the North Atlantic from ship strikes resulted in some fairly simple (though not easy) ways to reduce strikes including shifting the location of some shipping lanes. Gaps exist on where and when these strikes occur, why they occur, and what specific measures can reduce their occurrence.

24.5 LIST OF LITERATURE CITED—MARINE MAMMALS

- Au, W.W.L. and M. Green. 2000. Acoustic interaction of humpback whales and whale-watching boats. *Marine Environmental Research* 49(5):469-481.
- Au, W.W.L. 2006. Anthropogenic noise and baleen whales: A perspective from humpback whale acoustics. In: 151st Meeting of the Acoustical Society of America, *Journal of the Acoustical Society of America* 119:3402.
- Baird, R.W., P.J. Stacey, D.A. Duffus and K.M. Langelier. 2002. An evaluation of gray whale (*Eschrichtius robustus*) mortality incidental to fishing operations in British Columbia, Canada. *Journal of Cetacean Research and Management* 4(3):289-296.
- Barlow, J. and G.A. Cameron. 2003. Field experiments show that acoustic pingers reduce marine mammal bycatch in the California drift gill net fishery. *Marine Mammal Science* 19(2):265-283.
- Barlow, J. and K.A. Forney. 2007. Abundance and population density of cetaceans in the California Current ecosystem. *Fishery Bulletin* 105(4): 509-526.
- Barlow, J. and R. Gisiner. 2006. Mitigating, monitoring and assessing the effects of anthropogenic sound on beaked whales. *Journal of Cetacean Research and Management* 7(3):239-249.
- Boehlert, G.W., G. R. McMurray and C. E. Tortorici. 2008. Ecological effects of wave energy development in the Pacific Northwest: a scientific workshop, October 11-12, 2007. U.S. Dept. of Commerce. NMFS-F/SPO-92. 174 pp.
- Brownell, R.L., Jr., P.J. Clapham, T. Miyashita and T. Kasuya. 2001. Conservation status of North Pacific right whales. *Journal of Cetacean Research and Management (Special Issue)* 2:269-286.

- Bryant, P.J., C.M. Lafferty and S.K. Lafferty. 1984. Reoccupation of Laguna Guerrero Negro, Baja California, Mexico, by gray whales. In: Jones, M.L., S.L. Swartz, and S. Leatherwood. The Gray Whale *Eschrichtius robustus*. New York: Academic Press. Pp. 375-387.
- Buckstaff, K.C. 2004. Effects of watercraft noise on the acoustic behavior of bottlenose dolphins, *Tursiops truncatus*, in Sarasota Bay, Florida. *Marine Mammal Science* 20(4):709-725.
- Calambokidis, J. and J. Barlow. 2004. Abundance of blue and humpback whales in the eastern North Pacific estimated by capture-recapture and line-transect methods. *Marine Mammal Science* 20(1):63-85.
- Carreta, J.V., J. Barlow and L. Enriquez. 2008. Acoustic pingers eliminate beaked whale bycatch in a gill net fishery. *Marine Mammal Science* 24(4):956-961.
- Carstensen, J., O.D. Henriksen and J. Teilmann. 2006. Impacts of offshore wind farm construction on harbour porpoise: Acoustic monitoring of echolocation activity using porpoise detectors (T-PODs). *Marine Ecology Progress Series* 321:295-308.
- Cox, T.M., T.J. Ragen, A. J. Read, E. Vos, R.W. Baird, K. Balcomb, J. Barlow, J. Caldwell, T. Cranford, L. Crum, A. D'amico, G. D'spain, A. Fernández, J. Finneran, R. Gentry, W. Gerth, F. Gulland, J. Hildebrand, D. Houser, T. Huller, P. D. Jepson, D. Ketten, C. D. Macleod, P. Miller, S. Moore, D. C. Mountain, D. Palka, P. Ponganis, S. Rommel, T. Rowles, B. Taylor, P. Tyack, D. Wartzok, R. Gisiner, J. Mead and L. Brenner. 2006. Understanding the impacts of anthropogenic sound on beaked whales. *Journal of Cetacean Research and Management* 7(3):177-187.
- Dahlheim, M.E. 1987. Bio-acoustics of the gray whale (*Eschrichtius robustus*). PhD Dissertation, University of British Columbia. 315 pp.
- Dohl, T.P. and R. Guess. 1979. Evidence for increasing offshore migration of the California gray whale, *Eschrichtius robustus* in Southern California, 1975 through 1978. In: Third Biennial Conference on the Biology of Marine Mammals, Seattle.
- Douglas, A.B., J. Calambokidis, L.M. Munger, M.S. Soldevilla, A.M. Havron, D.L. Camacho, G.S. Campbell and J.A. Hildebrand. In preparation. Seasonality, diversity and relative density of marine mammals off Southern California, based on sighting data collected on quarterly California Cooperative Oceanic Fisheries Investigation cruises 2004-2008.
- Douglas, A.B., J. Calambokidis, S. Raverty, S.J. Jefferies, D.M. Lambourn and S.A. Norman. 2008. Incidence of ship strikes of large whales in Washington State. *Journal of the Marine Biological Association of the United Kingdom* 88(6):1121-1132.
- Duffus, D.A. 1996. The recreational use of gray whales in southern Clayoquot Sound, Canada. *Applied Geography* 16:179-190.

- Erbe, C. 2002. Underwater noise of whale-watching boats and potential effects on killer whales (*Orcinus orca*), based on an acoustic impact model. *Marine Mammal Science* 18(2):394-418.
- Evans, P.G.H. 2002. Biology of cetaceans of the North-east Atlantic (in relation to seismic energy). In: Tasker, M. and C. Weir. *Proceedings of the Seismic and Marine Mammal Workshop*, London. Chapter 5: 35 pp.
- Evans, P.G.H. 2003. Shipping as a possible source of disturbance to cetaceans in the ASCOBANS region. In: 4th Meeting of the Parties, Esbjerg, Denmark. Sea Watch Foundation. Document MOP4/DOC17: 88.
- Evans, P.G.H. and H. Nice. 1996. Review of the effects of underwater sound generated by seismic surveys on cetaceans. Unpublished Report, Sea Watch Foundation, Oxford, England.
- Finneran, J.J., C.E. Schlundt, D.A. Carder, J.A. Clark, J.A. Young, J.B. Gaspin, and S.H. Ridgway. 2000. Auditory and behavioral responses of bottlenose dolphins (*Tursiops truncatus*) and a beluga whale (*Delphinapterus leucas*) to impulsive sounds resembling distant signatures of underwater explosions. *Journal of the Acoustical Society of America* 108(1):417-431.
- Finneran, J., C.E. Schlundt, R. Dear, D.A. Carder and S.H. Ridgway. 2002. Temporary shift in masked hearing thresholds in odontocetes after exposure to single underwater impulses from a seismic watergun. *Journal of the Acoustical Society of America* 111(6):2929-2940.
- Foote, A.D., R.W. Osborne and A.R. Hoesel. 2004. Whale-call response to masking boat noise. *Nature* 428(6986):910.
- Frost, K.J., L.F. Lowry, J.R. Gilbert and J.J. Burns. 1988. Ringed seal monitoring: relationships of distribution and abundance to habitat attributes and industrial activities. U.S. Dept. of Commerce. Pp. 345-445.
- Frost, K.J., L.F. Lowry and J.M. Ver Hoef. 1999. Monitoring the trend of harbor seals in Prince William Sound, Alaska, after the Exxon Valdez oil spill. *Marine Mammal Science* 15(2):494-506.
- Garrott, R.A., L.L. Eberhardt and D.M. Burn. 1993. Mortality of sea otters in Prince William Sound following the Exxon Valdez oil spill. *Marine Mammal Science* 9(4):343-359.
- Gearin, P.J., M.E. Gosho, J.L. Laake, L. Cooke, R.L. DeLong and K.M. Hughes. 2000. Experimental testing of acoustic alarms (pingers) to reduce bycatch of harbour porpoise, *Phocoena phocoena*, in the state of Washington. *Journal of Cetacean Research and Management* 2(1):1-10.
- Geraci, J.R. and D.J. St. Albin. 1990. *Sea Mammals and Oil: Confronting the Risks*. San Diego, CA: Academic Press.

- Gordon, J., D. Gillespie, J. Potter, A. Frantzis, M.P. Simmonds, R. Swift and D. Thompson. 2004. A review of the effects of seismic surveys on marine mammals. *Marine Technology Society Journal* 37(4):16-34.
- Hanson, M.T. and R.H. Defran. 1993. The behaviour and feeding ecology of the Pacific Coast bottlenose dolphin, *Tursiops truncatus*. *Aquatic Mammals* 19(3):127-142.
- Harris, R.E., G.W. Miller and W.J. Richardson. 2001. Seal responses to airgun sounds during summer seismic surveys in the Alaskan Beaufort Sea. *Marine Mammal Science* 17(4):795-812.
- Henriksen, O.D., J. Tougaard, L. Miller and R. Dietz. 2003. Underwater noise from offshore wind turbines: Expected impacts on harbor seals and harbor porpoises. In: *Environmental Consequences of Underwater Sound (ECOUS) Symposium*. San Antonio, Texas, 12-16 May 2003. Abstract only.
- Hildebrand, J. 2005. Impacts of anthropogenic sound. In: Reynolds, II, J.E., W.F. Perrin, R.R. Reeves, S. Montgomery and T.J. Ragen. *Marine Mammal Research: Conservation Beyond Crisis*. Baltimore: Johns Hopkins Press Pp. 101-123.
- Holt, M.M., D.P. Noren, V. Veirs, C.K. Emmons and S. Viers. 2009. Speaking up: Killer whales (*Orcinus orca*) increase their call amplitude in response to vessel noise. *The Journal of the Acoustical Society of America* 125(1):EL27-EL32.
- Jensen, F.H., M. Wahlberg, L. Bejder and P.T. Madsen. 2008. Noise levels and masking potential of small whale-watching and research vessels around two delphinid species. *Bioacoustics* 17:166-168.
- Johnson, A., G. Salvador, J. Kenney, J. Robbins, S.D. Kraus, S. Landry and P.J. Clapham. 2005. Fishing gear involved in entanglements of right and humpback whales. *Marine Mammal Science* 21(4):636-645.
- Jones, M.L., S.L. Swartz and M.E. Dahlheim. 1994. Census of gray whale abundance in San Ignacio Lagoon: A follow-up study in response to low whale counts recorded during an acoustic playback study of noise-effects on gray whales. Report to Marine Mammal Commission. Washington, DC. 38 Pp..
- Ketten, D. 1995. Estimates of blast injury and acoustic trauma zones for marine mammals from underwater explosions. In: Kastelein, R.A., J.A. Thomas, and P.E. Nachtigall. *Sensory Systems of Aquatic Mammals*. Woerden: De Spil Publ. 391-407.
- Laist, D.W., A.R. Knowlton, J. Mead, A.S. Collet and M. Podesta. 2001. Collisions between ships and whales. *Marine Mammal Science* 17(1):35-75.
- Leatherwood, S. and R.R. Reeves. 1983. *Sierra Club Handbook of Whales and Dolphins*. San Francisco: Sierra Club.

- Ljungblad, D.K., B. Wursig, S.L. Swartz and J.M. Keene. 1988. Observations on the behavioral responses of bowhead whales (*Balaena mysticetus*) to active geophysical vessels in the Alaskan Beaufort Sea [USA]. *Arctic* 41(3):183-194.
- Loughlin, T.R. 1994. *Marine Mammals and the Exxon Valdez*. San Diego: Academic Press. 395 pp.
- Macleod, C.D. and A. D'amico. 2006. A review of beaked whale behavior and ecology in relation to assessing and mitigating impacts of anthropogenic noise. *Journal of Cetacean Research and Management* 7(3):211-221.
- Madsen, P.T., M. Johnson, P.J.O. Miller, N. Aguilar Soto, J. Lynch and P. Tyack. 2006a. Quantitative measures of air-gun pulses recorded on sperm whales (*Physeter macrocephalus*) using acoustic tags during controlled exposure experiments. *Journal of the Acoustical Society of America* 120(4):2366-2379.
- Madsen, P.T., B. Mohl, K. Nielsen and M. Wahlberg. 2002. Male sperm whale behaviour during exposures to distant seismic survey pulses. *Aquatic Mammals* 28(3):231-240.
- Madsen, P.T., M. Wahlberg, J. Tougaard, K. Lucke and P. Tyack. 2006b. Wind turbine underwater noise and marine mammals: Implications of current knowledge and data needs. *Marine Ecology Progress Series* 309:279-295.
- Malme, C.I., P.R. Miles, C.W. Clark, P. Tyack and J.E. Bird. 1983. Investigations of the potential effects of underwater noise from petroleum industry activities on migrating gray whale behavior. Final report for the period of 7 June 1982-31 July 1983 to MMS-Alaska OCS Office.
- Malme, C.I., P.R. Miles, P. Tyack, C.W. Clark and J.E. Bird. 1985. Investigation of the potential effects of underwater noise from petroleum industry activities on feeding humpback whale behavior. Contract Report to U.S. Dept. of the Interior, MMS-Alaska OCS Office. 205 pp..
- Malme, C.I., B. Wursig, J.E. Bird and P.L. Tyack. 1986. Behavioral responses of gray whales to industrial noise: Feeding observations and predictive modeling. Final Report to the OCS Assessment Program. 207 pp.
- Malme, C.I., B. Wursig, J.E. Bird and P.L. Tyack. 1987. Observations of feeding gray whale responses to controlled industrial noise exposure. In: *Ninth International Conference on Port and Ocean Engineering Under Arctic Conditions*, Fairbanks, Alaska. The Geophysical Institute, University of Alaska. Pp. 55-73.
- Mate, B.R. and J. Urbán-Ramirez. 2003. A note on the route and speed of a gray whale on its northern migration from Mexico to central California, tracked by satellite-monitored radio tag. *Journal of Cetacean Research and Management* 5(2):155-157.

- Mccauley, R.D., J. Fewtrell, A.J. Duncan, C. Jenner, M.-N. Jenner, J.D. Penrose, R.I.T. Prince, A. Adhitya, J. Murdoch and K. McCabe. 2000. Marine seismic surveys—a study of environmental implications. *APPEA* 40:692-708.
- Mcdonald, M., J. Hildebrand and S.C. Webb. 1995. Blue and fin whales observed on a seafloor array in the northeast Pacific. *Journal of the Acoustical Society of America* 98:712-721.
- Miller, P.J.O., M.P. Johnson, P.T. Madsen, N. Biassoni, M. Quero and P.L. Tyack. 2009. Using at-sea experiments to study the effects of airguns on the foraging behavior of sperm whales in the Gulf of Mexico. *Deep-Sea Research*, doi:10.1016/j.dsr.2009.02.008.
- Monson, D.J., D.F. Doak, B.E. Ballachey, A. Johnson and J.L. Bodkin. 2000. Long-term impacts of the Exxon Valdez oil spill on sea otters, assessed through age-dependent mortality patterns. *Proceedings of the National Academy of Sciences of the United States of America* 97(12):6562-6567.
- Moore, S.E. and J.T. Clarke. 2002. Potential impact of offshore human activities on gray whales (*Eschrichtius robustus*). *Journal of Cetacean Research and Management* 4(1):19-25.
- Nowacek, D.P., L.H. Thorne, D.W. Johnston and P.L. Tyack. 2007. Responses of cetaceans to anthropogenic noise. *Mammal review* 37(2):81-115.
- Nowacek, S.M., R.S. Wells and A.R. Solow. 2001. Short-term effects of boat traffic on bottlenose dolphins, *Tursiops truncatus*, in Sarasota Bay, Florida. *Marine Mammal Science* 17(4):673-688.
- Osborne, R.W., J. Calambokidis and E.M. Dorsey. 1988. *A Guide to Marine Mammals of Greater Puget Sound*. Anacortes, WA: Island Publishers.
- Patenaude, N.J., W.J. Richardson, M.A. Smultea, W.R. Koski, G.W. Miller, B. Wursig and C.R. Greene, Jr. 2002. Aircraft sound and disturbance to bowhead and beluga whales during spring migration in the Alaskan Beaufort Sea. *Marine Mammal Science* 18(2):309-335.
- Peterson, C.H. and L. Holland-Bartels. 2002. Chronic impacts of oil pollution in the sea: Risks to vertebrate predators. *Marine Ecology Progress Series* 241:235-236.
- Peterson, C.H., S.D. Rice, J.W. Short, D. Esler, J.L. Bodkin, B.E. Ballachey and D.B. Irons. 2003. Long-term ecosystem response to the Exxon Valdez oil spill. *Science* 302(5653):2082-2086.
- Reeves, R.R., D.K. Ljungblad and J.T. Clarke. 1984. Bowhead whales and acoustic seismic surveys in the Beaufort Sea. *Polar Record* 22(138):271-280.
- Rice, D.W. 1965. Offshore southward migration of gray whales off Southern California. (*Eschrichtius robustus*). *Journal of Mammalogy* 46(3):504-505.

- Richardson, W.J. 2002. Marine mammals versus seismic and other acoustic surveys: Introduction to the noise issues. *Polarforschung* 72(2-3):63-67.
- Richardson, W.J., M.A. Fraker, B. Wursig and R.S. Wells. 1985. Behavior of bowhead whales *Balaena mysticetus* summering in the Beaufort Sea: Reactions to industrial activities. *Biological Conservation* 32(3):195-230.
- Richardson, W.J., C.R. Green, Jr, C.I. Malme and D.H. Thomson. 1995. Marine mammals and noise. San Diego: Academic Press. 576 pp.
- Richardson, W.J., G.W. Miller and C.R. Greene Jr. 1999. Displacement of migrating bowhead whales by sounds from seismic surveys in shallow waters of the Beaufort Sea. *The Journal of the Acoustical Society of America* 106:2281.
- Richardson, W.J. and B. Würsig. 1997. Influences of man-made noise and other human actions on cetacean behaviour. *Marine and Freshwater Behaviour and Physiology* 29(1):183-209.
- Richardson, W.J., B. Wursig and C. Greene Jr. 1990. Reactions of bowhead whales, *Balaena mysticetus*, to drilling and dredging noise in the Canadian Beaufort Sea. *Marine Environmental Research* 29(2):135-160.
- Schwarz, L.K. 2002. The impact of anthropogenic activities on the behavior of migrating eastern North Pacific gray whales (*Eschrichtius robustus*) M S Thesis, San Diego State University. 101 pp.
- Southall, B.L., A.E. Bowles, W.T. Ellison, J.J. Finneran, R.L. Gentry, C.R. Greene, Jr, D.A. Kastak, D.R. Ketter, J.H. Miller, P.E. Nachigall, W.J. Richardson, J.A. Thomas and P.L. Tyack. 2007. Marine mammal noise exposure criteria: initial scientific recommendations. *Aquatic Mammals* 33:414-521.
- Stafford, K.M., C.G. Fox and D.S. Clark. 1998. Long-range acoustic detection and localization of blue whale calls in the northeast Pacific Ocean. *Acoustical Society of America* 104:3616-3625.
- Taylor, B., J. Barlow, R. Pitman, L. Ballance, T. Klinger, D. Demaster, J. Hildebrand, J. Urban, D. Palacios and J. Mead. 2004. A call for research to assess risk of acoustic impact on beaked whale populations. In: Scientific Committee at the 56th Meeting of the International Whaling Commission. 29 pp.
- Teilmann, J., J. Carstensen, R. Dietz and S.M.E. Edren. 2004. Effect on seals at Rodsand seal sanctuary from the construction of Nysted Offshore Wind Farm based on aerial surveys. Technical Report to Ministry of Environment, Denmark, 33 pp.
- Teilmann, J., J. Tougaard and J. Carstensen. 2006a. Summary on harbour porpoise monitoring 1999-2006 around Nysted and Horns Rev Offshore Wind Farms. Technical Report to Ministry of Environment, Denmark.

- Teilmann, J., J. Tougaard and J. Carstensen. 2006b. Summary on seal monitoring 1999-2005 around Nysted and Horns Rev Offshore Wind Farms. Final Report to Ministry of Environment, Denmark.
- Thomson, D.H. and S.R. Johnson. 1996. Effects of offshore oil development and production activities off Sakhalin Island and sea associated birds and marine mammals. Report to Marathon Oil, Houston, TX. 82 pp.
- Todd, S., P. Stevick, P. Lein, M. Fernanda and D. Ketten. 1996. Behavioural effects of exposure to underwater explosions in humpback whales (*Megaptera novaeangliae*). Canadian Journal of Zoology 74(9):1661-1672.
- Tougaard, J., J. Carstensen, O.D. Henriksen, H. Skov and J. Teilmann. 2003. Short-term effects of the construction of wind turbines on harbour porpoises at Horns Reef. Report to Techwise A/S, Roskilde.
- Tougaard, J., S. Tougaard, R.C. Jensen, T. Jensen, J. Teilmann, D. Adelung, N. Liebsch and G. Muller. 2006. Harbour seals at Horns Reef before, during and after construction of Horns Rev Offshore Wind Farm. Biological Papers from the Fisheries and Maritime Museum, Esbjerg, Denmark. 67 pp.
- Tyack, P., I. Boyd, D.E. Claridge, C.W. Clark, D. Moretti and B. L. Southall. 2008. Effects of sound on the behavior of toothed whales. In: ACOUSTICS2008, 2923: (Abstract only).
- U.S. Dept. of the Interior, Minerals Management Service. 2006. Outer Continental Shelf Oil & Gas Leasing Program: 2007-2012: Draft EIA M. U.S. Dept. of the Interior, Herndon, VA. 320 pp.
- Vanderlaan, A.S.M. and C.T. Taggart. 2007. Vessel collisions with whales: The probability of lethal injury based on vessel speed. Marine Mammal Science 23(1):144-156.
- Wartzok, D., A.N. Popper, J. Gordon and J. Merrill. 2003. Factors affecting the responses of marine mammals to acoustic disturbance. Marine Technology Society Journal 37(4):6-15.
- Weller, D., S.H. Rickards, A.L. Bradford, A.M. Burdin and R.L. Brownell, Jr. 2006a. The influence of 1997 seismic surveys on the behavior of western gray whales off Sakhalin Island, Russia. In: International Whaling Commission, Paper SC/58/E4. 12 pp.
- Weller, D.W., G.A. Tsidulko, Y.V. Ivashchenko, A.M. Burdin and R.L. Brownell, Jr. 2006b. A re-evaluation of the influence of 2001 seismic surveys on western gray whales off Sakhalin Island, Russia. In: International Whaling Commission, Paper SC/58/E5: 9 pp.
- Williams, R., D.E. Bain, J.K.B. Ford and A.W. Trites. 2002. Behavioural responses of male killer whales to a "leapfrogging" vessel. Journal of Cetacean Research and Management 4(3):305-310.

25. ECOSYSTEM INTERRELATIONSHIPS

25.1 ALTERATION OF THE MARINE FOOD WEB

The installation of platforms adds artificial surfaces to ecosystem. These added structures can promote the establishment of artificial reef habitat. This habitat alteration has been observed and is well documented at several previously installed offshore structures in the Southern Study Area (USDOJ, MMS 2005), as well as elsewhere. Platforms provide hard substrates that foster growth of algae and sessile epifaunal invertebrates such as bryozoans, sponges, hydroids, barnacles, oysters, and mussels (Page and Dugan 1997). Organisms that attach and grow on the piles and platform supports provide habitat and food for many mobile invertebrates and fish. In addition to fouling organisms attached to the platform, benthic and pelagic species abundance below and surrounding the structure can be augmented. For example large mussel mounds are found on the benthic substrates around many platforms in Southern California (Helvey 2002). Richness and diversity of benthos tend to decrease with distance from the structure. Studies carried out at artificial reefs established on oil and gas platforms have shown that fish are attracted to such structures (Gunter and Geyer 1955; Sonnier et al. 1976; George and Thomas 1979; Gallaway and Lewbel 1982; Love and Westphal 1990; Love et al. 1993). The attraction of biota to artificial reefs and their longevity at particular structures vary depending upon the ecological role of the species in question, as well as environmental conditions. Several positive ecological, recreational, and commercial impacts have been associated with artificial reef habitat creation, including increased biodiversity and fisheries. These platforms create small, localized diverse ecosystems when built on shelf areas consisting of mostly low-relief, homogenous, soft-bottom habitat.

Propagation of nonnative and invasive species is a potential negative impact of artificial reefs along the coast. Increased number of, and decreased distance between, platforms may perpetuate a higher rate of island-hopping among organisms. Introducing nonnative habitat to the open ocean gives species a pathway through which they can expand their range; this could be true for native and nonnative species. The introduction of nonnative species is not a new issue for the Southern California Bight; however, continued vigilance aimed at keeping the number that become invasive to a minimum is of utmost concern. Invasive species can permanently alter the ecosystems and food webs in which they invade, resulting in regional extinctions and decreases in productivity and biodiversity (Ruiz et al. 2000).

Spilled oil has the potential to impact ecosystems in varying ways. Physical oiling can result in simply the loss of biomass or, more seriously, the loss of species in the affected communities. Recovery rates for different habitat types have been explored as part of remediation activities following spills. A review of current information can be found in French-McCay (2009). In general for intertidal invertebrates, French et al. (1996) has estimated that time for natural recovery is 3 to 5 years. Several post-spill monitoring studies of rocky intertidal areas show that cleanup activities tend to increase recovery time (potentially up to nine years) (Broman et al. 1983; Houghton et al. 1991; Rolan and Gallagher 1991). In some cases, where the structure-forming species actually stabilizes the habitat, it is conceivable that permanent modification of that habitat could result from an acute incident (USDOJ, MMS 2001). Oiled rocky intertidal

areas left to recover naturally show improvement within 2 to 5 years (Sell et al. 1995). Sandy beaches and mudflats can take anywhere from 1 to 5 years to fully recover after a spill event (French-McCay 2009). Seagrass beds have been observed to recover within seven months of a spill (Keller and Jackson 1991); however, longer recovery estimates (several years) are more typically made (French-McCay 2009). Recovery of benthic organisms and vegetation in oiled salt marsh habitat may take anywhere from 5 to 18 years to recover (French-McCay 2009). Subtidal kelp forests of the Pacific Coast are quick to recover biomass after both natural (e.g. storms, grazing; Graham 2002) and pollution (e.g. oil and sewer spills; Moody 1990; Tegner et al. 1995) events. Moody (1990) estimated that oiled kelp beds had 90 percent recovered in three to four years. However, after 14 years they had not fully recovered to pre-spill diversity.

Oil toxicity from a spill may or may not have a profound effect on the aquatic ecosystem. The toxicity of oil to organisms is largely due to exposure to and uptake of polyaromatic hydrocarbons (PAHs) (Anderson et al. 1974; Malins and Hodgins 1981; Neff and Anderson 1981), with the effects of the mixture of hydrocarbons being additive (McCarty et al. 1992; Swartz et al. 1995; DiToro et al. 2000; French-McCay 2002). Because accumulation of toxic concentrations within tissues takes hours to days before lethal levels are reached, only large spills of light crude oils and fuels would be expected to induce toxic effects on plankton (French-McCay 2002). However, even concentrations that create only sublethal effects on primary producers and other lower-trophic-level organisms can have lethal effects at higher trophic levels.

Bioaccumulation is the accumulation of toxins in higher trophic organisms; the rate of accumulation depends on many factors, including uptake and metabolic rates (Neff 2002). Because the transfer of energy between trophic levels is inefficient, predators must consume large amounts of prey to meet their energy demands. Thus, a small concentration of a toxin in prey items can lead to a significant accumulation of the toxin in higher predators. In the Southern California Bight one of the most famous cases of bioaccumulation involves DDE (a derivative of DDT) and PCBs. The mechanisms of toxin uptake for sea lions and bald eagles were modeled and results showed most of the accumulation came as a direct result of consuming contaminated prey that had lower individual concentrations of the chemicals than the predator (Connolly and Glaser 2002; Glaser and Connolly 2002).

25.2 PATTERNS OF PREDATION, COMPETITION, AND DISEASE

Alterations such as installation of piles and removal of surface substrates, leading to deepening and exposure of different subsurface sediments, can lead to shifts in biological composition (Newell et al. 1998). Pipeline trenches that are backfilled with sediment similar to their original fill, or that allowed to naturally backfill over time, may or may not return to baseline conditions. Ecological services within disturbed sediments could be altered for many years depending upon the amount of disturbance, the size of affected areas, and the types of communities present (USDOJ, MMS 2007). Shifts in benthic invertebrate assemblage could affect demersal (bottom feeding) fish species that utilize the habitat for foraging. In offshore habitats such as soft sediments, the effects of physical alteration are likely to be temporary as neighboring infaunal invertebrates can recolonize after installation. However, in more sensitive areas, such as rocky reefs containing slow-growing epifaunal organisms, effects may be greater and recovery can take

longer. Pre-disturbance conditions may never be reestablished even if pipeline trenches or platform areas are returned to their original physical makeup. Diversity and abundance may be restored over time, but shifts in species composition may occur.

At the ecosystem level effects of toxicity will vary in a similar manner. Adverse impacts to plankton resources would be localized and temporary, as generation times are days to weeks, and recovery would be rapid. At trophic levels with longer generation times, spills could have larger impacts such as reduced reproductive rates and increased mortality. While this could have a serious impact at the population level, prolonged effects are not likely, because oil spills are temporary occurrences. The largest bioaccumulation-related impacts are a result of continued contaminant release or persistence. Because spilled oil of a finite volume weathers and eventually breaks down, bioaccumulation is not likely to be a major impact. However, chronic discharges could lead to localized effects in areas immediately surrounding an outfall.

25.3 SUMMARY AND DATA GAPS

Ecosystem impacts of oil and gas production include lost biomass after a spill or construction activities. Some modeling work has been performed to quantify this impact (French-McCay 2009); however, more work quantifying this reduction is needed to fully understand the cascading effects. In general, the creation of artificial reefs is perceived as a positive impact of offshore development. This concept needs to be reevaluated in terms of bioinvasion pathways and the health of organisms found on these reefs. These reefs may provide nonnative and potentially invasive species with enough habitat to allow them to increase their range and move into pristine habitats. Additionally, fouling organisms found on these artificial structures could bioaccumulate toxins due to the close proximity to pollutants. These toxins have the potential to move up the food web as predators are attracted to the artificial reefs because of the high concentration of biomass.

25.4 LIST OF LITERATURE CITED—ECOSYSTEM INTERRELATIONSHIPS

- Anderson, J.W., J.M. Neff, B.A. Cox, H.E. Tatem and G.M. Hightower. 1974. Characteristics of dispersions and water-soluble extracts of crude and refined oils and their toxicity to estuarine crustaceans and fish. *Marine Biology* 27:75-88.
- Broman, D., B. Ganning and C. Lindblad. 1983. Effects of high pressure, hot water shore cleaning after oil spills on shore ecosystems in the Northern Baltic proper. *Marine Environmental Research* 10(3):173-187.
- Connolly, J.P. and D. Glaser. 2002. A model of p,p0-DDE bioaccumulation in female sea lions of the California Channel Islands. *Continental Shelf Research* 22:1059-1078.
- DiToro, D.M., J.A. McGrath and D.J. Hansen. 2000. Technical basis for narcotic chemicals and polycyclic aromatic hydrocarbon criteria. I. Water and tissue. *Environmental Toxicology and Chemistry* 19(8):1951-1970.

- French, D.P., H. Rines and A. Keller. 1996. The CERCLA Type A natural resources damage assessment model for coastal and marine environments. Technical Documentation, Volume IV Biological Database. 40 pp.
- French-McCay, D.P. 2002. Development and application of an oil toxicity and exposure model, OilToxEx. *Environmental Toxicology and Chemistry* 21:2080-2094.
- French-McCay, D. 2009. State-of-the-art and research needs for oil spill impact assessment modeling. In: Proceedings of the 32nd Arctic and Marine Oil Spill Program (AMOP) Technical Seminar on Environmental Contamination and Response. Emergencies Science Division, Environment Canada, Ottawa, ON, Canada. Pp. 601-653.
- Gallaway, B.J. and G.S. Lewbel. 1982. The ecology of petroleum platforms in the Northwestern Gulf of Mexico: A community profile. U.S. Dept. of the Interior, U.S. Fish and Wildlife Service, Office of Biological Services, Washington, DC. FWS/OBS-82/27.
- George, R.Y. and P.J. Thomas. 1979. Biofouling Community Dynamics in Louisiana Shelf Oil Platforms in the Gulf of Mexico. *Rice University Study* 65(4&5):553-574.
- Glaser, D. and J.P. Connolly. 2002. A model of p,p0-DDE and total PCB bioaccumulation in birds from the Southern California Bight. *Continental Shelf Research* 22:1079-1100.
- Graham, M. 2002. Prolonged reproductive consequences of short-term biomass loss in seaweeds. *Marine Biology* 140:901-911.
- Gunter, G. and R.A. Geyer. 1955. Studies of fouling organisms of the northwest Gulf of Mexico. Published at the Institute of Marine Science, University of Texas 4(1):37-87.
- Helvey, M. 2002. Are Southern California oil and gas platforms essential fish habitat? *ICES Journal of Marine Science* 59:S266-S271.
- Houghton, J.P., D.C. Lees, W.B. Driskell and A.J. Mearns. 1991. Impacts of the Exxon Valdez Spill and Subsequent Cleanup on Intertidal Biota-1 year later. In: Proceedings of the 1991 Oil Spill Conference. Washington, DC: American Petroleum Institute. Pp. 467-475.
- Keller, B.D. and J.B.C. Jackson. 1991. Long-term assessment of the oil spill at Bahia Las Minas, Panama, interim report, Volume I: Executive summary. U.S. Dept. of the Interior, Minerals Management Service, Gulf of Mexico OCS Regional Office, New Orleans, LA. OCS Study MMS 90-0030. 49 pp.
- Love, M.S., J. Hyland, A. Ebeling, T. Herrlinger, A. Brooks and E. Imamura. 1993. A pilot study of the distribution and abundances of Rockfishes in relation to natural environmental factors and an offshore oil and gas production platform off the Coast of Southern California. Effects of OCS oil and gas production platforms on rocky reef fishes and fisheries. OCS Study MMS 92-0021.

- Love, M.S. and W. Westphal. 1990. Comparison of fishes taken by a sportfishing party vessel around oil platforms and adjacent natural reefs near Santa Barbara, California. *Fishery Bulletin* 88(3):599-605.
- Malins, D.C. and H.O. Hodgins. 1981. Petroleum and marine fishes: A review of uptake, disposition, and effects. *Environmental Science and Technology* 15(11):1273-1280.
- McCarty, L.S., G.W. Ozburn, A.D. Smith and D.G. Dixon. 1992. Toxicokinetic modeling of mixtures of organic chemicals. *Environmental Toxicology and Chemistry* 11:1037-1047.
- Moody, A. 1990. A review of oil effects on marine plants, report to environmental Canada #91 05066, Environmental Protection, River Road Environmental Technology Centre, Ottawa, CA. 30 pp.
- Neff, J.M. 2002. Bioaccumulation in marine organisms: Effect of contaminants from oil well produced water. Amsterdam, The Netherlands: Elsevier.
- Neff, J.M. and J.W. Anderson. 1981. Response of marine animals to petroleum and specific petroleum hydrocarbons. Applied Science Publishers, Halsted Press, John Wiley & Sons, NY. 177 pp.
- Newell, R.C., L.J. Seiderer and D.R. Hitchcock. 1998. The impact of dredging works in coastal waters: A review of the sensitivity to disturbance and subsequent recovery of biological resources on the sea bed. *Oceanography and Marine Biology: An Annual Review* 36:127-178.
- Page, M. and J. Dugan. 1997. Effect of offshore oil platform structures on the distribution pattern of commercially important benthic crustaceans, with emphasis on the Rock crab. In: Manago, F. and B. Williamson, eds., *Proceedings: Public Workshop, Decommissioning and Removal of Oil and Gas Facilities Offshore California: Recent Experiences and Future Deepwater Challenges*. Coastal Research Center, Marine Science Institute, University of California, Santa Barbara, CA. OCS Study MMS 98-0023.
- Rolan, R.G. and R. Gallagher. 1991. Recovery of intertidal biotic communities at Sullom Voe following the Esso Bernicia oil spill of 1978. In: *Proceedings of the 1991 International Oil Spill Conference*, API Publ. 4529. Washington, DC: American Petroleum Institute. Pp. 461-465.
- Ruiz, G., P. Fofonoff, J. Carlton, M. Wonham and A. Hines. 2000. Invasion of coastal marine communities in North America: Apparent patterns, processes, and biases. *Annual Review of Ecology and Systematics* 31:481-531.
- Sell, D., L. Conway, T. Clark, G.B. Picken, J.M. Baker, G.M. Dunnet, A.D. McIntyre and R.B. Clark. 1995. Scientific criteria to optimize oil spill clean up. In: *Proceedings of the 1995 Oil Spill Conference*. Washington, DC: American Petroleum Institute. Pp. 595-611.

- Sonnier, F., J. Teerling and H.D. Hoese. 1976. Observations on the offshore reef and platform fish and fauna of Louisiana. *Copeia* 1976(1):105-111.
- Swartz, R.C., D.W. Schults, R.J. Ozretich, J.O. Lamberson, F.A. Cole, T.H. DeWitt, M.S. Redmond and S.P. Ferraro. 1995. Σ PAH: A model to predict the toxicity of polynuclear aromatic hydrocarbon mixtures in field-collected sediments. *Journal of Environmental Toxicology and Chemistry* 14(11):1977-1987.
- Tegner, M.J., P.K. Dayton, P.B. Edwards, K.L. Riser, D.B. Chadwick, T.A. Dean and L. Deysher. 1995. Effects of a large sewage spill on a kelp forest community: Catastrophe or disturbance? *Marine Environmental Research* 40(2):181-224.
- U.S. Dept. of the Interior, Minerals Management Service (MMS). 2001. Deepwater program: Literature review, environmental risks of chemical products used in Gulf of Mexico deepwater oil and gas operations. 2 vols. U.S. Dept. of the Interior, Minerals Management Service, Gulf of Mexico OCS Region, New Orleans, LA. OCS Studies 2001-011 and 2001-012.
- U.S. Dept. of the Interior, Minerals Management Service (MMS). 2005. Survey of invertebrate and algal communities on offshore oil and gas platforms in Southern California. U.S. Dept. of the Interior, Minerals Management Service, Pacific OCS Region, Camarillo, CA. OCS Study MMS 2005-070.
- U.S. Dept. of the Interior, Minerals Management Service (MMS). 2007. Programmatic environmental impact statement for alternative energy development and production and alternate uses of facilities on the Outer Continental Shelf, Volume I: Executive summary through chapter 4. U.S. Dept. of the Interior, Minerals Management Service. OCS EIS/EA MMS 2007-046.

26. AREAS OF SPECIAL CONCERN

The effects of oil and gas development on areas of special concern will be similar to effects on areas that are not designated. However, particular attention should be paid to the reason for the special designation as it usually requires a unique circumstance and therefore unique potential for effects. Potential impacts to the various categories of resources are reviewed in preceding chapters.

26.1 CONTAMINATION OF PRISTINE AREAS

Marine Protected Areas, and other protected habitats including estuaries and wetlands, will fundamentally be affected in the same manner as habitats that are not protected. However, these areas have been designated to protect certain resources and therefore injury to these locations may have a greater impact than similar effects to undesignated areas. Potential injuries, including lowered system productivity, loss of pristine habitat, and disturbance of sensitive species, could result from oil spills, sediment resuspension, and the degradation, modification, and removal of benthic habitats associated with the development of oil and gas. The Channel Islands Marine Sanctuary (CINMS) was created to preserve and protect the unique habitats found around the islands (NMSP 2008). Since 1980 CINMS has worked to protect and restore the natural habitats, ecological services, and biological communities. An additional goal is to promote compatible use between resource protection and public use (NMSP 2008). Therefore, the habitats of CINMS represent relatively undisturbed and highly productive habitats; because of this, any injury caused by human activity could result in less than 100 percent recovery regardless of restoration effort.

The efficacy of Marine Protected Areas is currently under scrutiny. One of the current debates is over their effects on fish stocks and fishery management. Despite the continued discussion on whether they help or hurt the fishing industry, there is enough evidence to suggest that production within the reserves can augment lost production adjacent to the reserve (Halpern and Warner 2003). In these areas of higher productivity than unprotected and unfished areas, adverse effects such as spills, sediment resuspension, and bottom habitat disturbance due to oil and gas development could produce larger impacts to both the protected and the unprotected ecosystems.

26.2 RESUSPENSION OF SEDIMENTS AND DEPOSITS

Archeological sites, including shipwrecks and anthropogenic artifacts, can be found throughout the Southern Study Area. These areas provide additional physical barriers to the sea floor and are therefore not likely to be considered for oil and gas development. However, if development took place in close proximity to these structures relocation could be necessary. The movement of artifacts may be hindered by historical preservation issues but would not result in any additional sources of effects to the surrounding area. On the other hand, the relocation of a shipwreck could include the movement of hazardous materials. Some of the shipwrecks in the area could contain leaked fuel or other hazardous materials. If this is the case, any disturbance to the wreck could result in accidental release of these materials.

In cases where development occurs in close proximity to shipwrecks, but far enough from them to avoid a relocation issue, these historical structures could be covered by excess sedimentation. While this would be a benign effect to the structure, it could negatively affect viewing potential or preservation activities.

Similar to shipwrecks, dumping grounds need to be assessed with care during the development for oil and gas. In most dumping cases, hazardous materials have been left on the bottom of the ocean, which means that any activity in the vicinity has the potential to disturb and potentially resuspend contaminated sediments. This is of particular concern for weapons that were dumped in unrecorded locations and for development near known contaminated areas. For instance, development near the Palos Verde Shelf, where known concentrations of contaminants are found in the sediments (USEPA 2003), would require extensive surveying to determine where contaminated sediments are and are not before any activities likely to cause resuspension (e.g. pile driving, drilling) could commence.

26.3 SUMMARY AND DATA GAPS

The Southern California Bight has been an active coastal zone for centuries. In recent decades much of the sensitive land and water has received protection in the form of sanctuaries and reserves. Similarly, artifacts of ancient and modern cultures can be found in this area and need to be protected and preserved. To prevent accidental disturbance of these sensitive areas they need to be accurately mapped. This can be a challenge, as not all historical locations have been discovered.

26.4 LIST OF LITERATURE CITED—AREAS OF SPECIAL CONCERN

- Halpern, B.S. and R.R. Warner. 2003. Matching marine reserve design to reserve objectives. *Proceedings of the Royal Society of London* 270:1871-1878.
- National Marine Sactuary Program (NMSP). 2008. Channel Islands National Marine Sanctuary Management Plan/Final Environmental Impact Statement. U.S. Dept. of Commerce. National Oceanic and Atmospheric Administration. Silver Spring, MD.
- U.S. Environmental Protection Agency (EPA). 2003. Ecological Risk Assessment for the Palos Verdes Shelf. U.S. EPA, Region IX. San Francisco, CA.

27. SOCIOECONOMIC IMPACTS

This synthesis evaluates information on some components of social, economic, and cultural concerns of oil and gas exploration and development in the Southern Study Area. The offshore part of the oil and gas industry in the Southern Study Area is found in four counties in California: Orange, Los Angeles, Ventura, and Santa Barbara.

Southern California was the site of the earliest attempts at U.S. offshore oil production in 1896, when oil derricks were placed on piers along the coast at Summerland near Santa Barbara (Molotch and Freudenburg 1996). The first offshore oil platform was installed in California in 1956, when platform Hazel was constructed in State waters east of Santa Barbara. Leasing in Federal waters off California began in 1966, and the first Federal platform, Hogan, was installed in 1967 (Molotch and Freudenburg 1996). Federal offshore oil production has accounted for roughly two-thirds of California's total offshore production in recent years (Kildow and Colgan 2005).

There has been no new offshore oil and gas development in the Southern Study Area since the early 1980s when a congressional moratorium prohibited oil and gas drilling along the East and West Coasts and in the eastern Gulf of Mexico. The Federal offshore leasing program in the study area has been a source of controversy since the 1940s, and it continues to be so. Social and political conflict has occurred as those who favor and oppose new oil and gas exploration and development confront one another. The anger, distrust, and turmoil related to this conflict must be included among the impacts of offshore oil and gas development in the Southern Study Area. Moreover, the conflict has an economic as well as an emotional dimension; the activism and litigation employed by opposing parties involve significant time and out-of-pocket costs.

The available information on the social and political conflict generated by offshore oil and gas exploration and development in the Southern Study Area is the main focus of this report because it encapsulates many of the social, economic, and cultural concerns of this development. The conflict is examined in three separate contexts: evolving perceptions of and attitudes toward offshore oil and gas development among California residents ([Section 27.1](#)), the controversy within California's fishing community over decommissioning options for obsolete offshore oil and gas facilities ([Section 27.2](#)), and the Federal-State conflict over development of offshore oil and gas resources ([Section 27.3](#)). This discussion includes information needs for describing certain socioeconomic impacts of offshore oil and gas development.

There is a wide range of other areas of social, cultural, and economic interests to be considered in environmental assessments of offshore oil and gas installations. A number of additional areas of social, economic, and cultural concern are briefly summarized in [Section 27.4](#).

27.1 PUBLIC ATTITUDES AND PERCEPTIONS

On January 28, 1969, less than 3 years after the first lease sale was held in the Southern Study Area, Union Oil's Platform A in Federal waters off the Santa Barbara County coast spilled more than 3 million gallons of oil, which washed up along a 35-mile stretch of coastline. The oil was

up to 6 inches thick on Santa Barbara's popular beaches, and the ecological impact was dramatic. Rescuers counted 3,600 dead seabirds, and a large number of poisoned seals and dolphins were found along the shoreline (Clarke and Hemphill 2002).

Now, after 4 decades, the impacts of the post-spill consequences for environmental policy outweigh historically the physical impacts of the spill itself. Clarke and Hemphill (2002) list some of the tangible long-term outcomes that were the direct result or a consequence of the Santa Barbara oil spill, including the following:

- A broad environmental grassroots movement was founded in the United States that included the first Earth Day in November of 1969.
- A statewide initiative created the California Coastal Commission, which today has powerful control over human activities that impact California's coastal areas.
- President Nixon signed the National Environmental Policy Act of 1969, leading the way to the 1970 establishment of the Environmental Protection Agency.

Moreover, the 1969 Santa Barbara oil spill reinforced public aversion to offshore drilling in most regions outside the Gulf of Mexico, leading to the moratorium on offshore development on the Outer Continental Shelf (OCS) beyond the western Gulf (Freudenburg and Gramling 2002). One of the most potent objections to lifting the ban has been to remind Americans of the devastation that resulted from the 1969 oil spill (Bridgers 2007; Cruickshank 2008). These far-reaching consequences of the 1969 Santa Barbara oil spill support the notion that sudden and catastrophic events can focus public awareness and influence subsequent policy (Birkland 1997; Birkland 2000).

For many long-term California residents the memories of the Santa Barbara oil spill caused by offshore drilling remain fresh (Brand 2008; Weintraub 2008; Welch 2008). Moreover, opposition to renewed offshore oil and gas development has been sustained and reinforced by other oil and gas accidents, even though they may have not involved the OCS; for example, in what may be the largest petroleum spill in United States history, Unocal Corporation spilled as much as 20 million gallons of petroleum off California's San Luis Obispo County over a period of 38 years, fouling the ground water, beach, and other habitats (Beamish 2000; Beamish 2001; Beamish 2002a; Beamish 2002b). And in 2008, on the eve of the 40th anniversary of the Santa Barbara oil spill, the same platform responsible for the 1969 spill was the source of a small spill that caused minor environmental damage (Preston 2008).

A key factor in the opposition to new oil and gas development may be the extraordinary value that a large majority of California residents place on the State's beaches and ocean, as shown in statewide surveys (Public Policy Institute of California 2003). Part of this strong desire to protect California's ocean and coastal environments from further pollution is based on economic necessity—marine tourism and recreation is one of the major growth engines not only for the

coastal counties but also for the entire State (Resources Agency of California 1997; Kildow and Colgan 2005), and any potential negative changes in tourism, such as those associated with an oil spill, are of major concern. California's beaches have a high direct economic use value and regional economic impact (Lew and Larson 2005; Wiley et al. 2006; Leeworthy et al. 2007; Leeworthy and Wiley 2007) and generate large revenues for local, State, and Federal governments (King and Potepan 1997; King 1999).

In recent years, opposition to offshore oil and gas development has also been fueled by a series of allegations of mismanagement and corruption aimed at the Federal program for collecting oil and gas royalties (U. S. Dept. of the Interior 2007b; U. S. Dept. of the Interior 2007a; U. S. Dept. of the Interior 2008). These allegations received widespread media attention (Savage 2002; Andrews 2006; Andrews 2007), which nurtured public distrust of the Department of the Interior's Bureau of Ocean Energy Management, Regulation, and Enforcement which spread to the Federal government as a whole, not to mention the oil industry.

However, while some Californians remain steadfast in their resistance to new offshore oil and gas development, other State residents are questioning whether rigid opposition to drilling makes sense given that oil and gas are not going to phase out as energy sources anytime soon. In addition, proponents argue that OCS oil and gas resources could make a substantial contribution to the national economy and national security (Hoyt 1995; Brown 2008; Casselman 2008; Kahn 2008; Mara 2008; Mcguire 2008).

Several California statewide surveys have been conducted to measure shifting public attitudes toward offshore oil and gas development projects. In 1998, a clear majority (75 percent) of respondents opposed offshore oil development (Michaud et al. 2008). The early 2000s showed a sharp increase in support for offshore oil and gas development; nevertheless, a 2002 poll conducted by the Public Policy Institute of California showed that a majority (59 percent) of the State's residents continued to oppose more oil drilling off the California coast, even if it meant higher gasoline prices for California drivers (Baldassare 2002). In 2008, however, the Public Policy Institute of California's survey found that a slight majority (51 percent) of Californians favored more oil drilling off California's coast (Baldassare et al. 2008).

In an analysis of Californians' opinions about offshore oil and gas development, Smith (2003) summarizes the trend data as follows: "...we do not see a public that is strongly pro-environmental or anti-oil drilling. Instead, we see a public that responds to changes in the price of gasoline. When gasoline prices were low or falling, public support for oil development fell; when gasoline prices were rising, public support for more drilling rose." The Public Policy Institute of California's poll in 2008 coincided with a period of record-high gasoline prices, with California overtaking Hawaii for the State with the most expensive gas. For further analysis of trends in the opinions of Californians about offshore oil drilling see Michaud et al. (2008); Smith (1995); Smith and Garcia (1995); Smith et al. (2005); and Smith (2002).

Santa Barbara County represents an interesting microcosm of the broader shift in public opinion toward offshore oil and gas development. The county is considered by some to be the "birthplace of the environmental movement" due to the 1969 Santa Barbara oil spill (Mcginnes

2005). However, from their first days, offshore oil projects were generally unwelcome by many in Santa Barbara County. As early as 1899, citizens of Santa Barbara displayed their antagonism by demolishing a derrick erected at Miramar Beach (Nevarez et al. 1998), and an offshore structure that an oil company attempted to build near Santa Barbara was razed in the 1920s (Molotch and Freudenburg 1996). Following the 1969 oil spill, the opposition in Santa Barbara County to offshore oil development became stronger and more permanently organized (Michaud et al. 2008). Pro-environmental sentiments in Santa Barbara County diffused through social networks of community and grassroots activists up and down the Pacific Coast (Morrill and Owen-Smith 2001). Local environmental organizations founded soon after the spill, such as Get Oil Out (GOO), are still active, and the Santa Barbara area continues to boast a dense network of indigenous institutions that demonstrate the breadth of local environmental concerns (Nevarez 1996). It is this long-standing and deeply-felt environmentalism in Santa Barbara County, as opposed to the NIMBY (“not in my backyard”) syndrome, that is the basis of local opposition to offshore oil drilling (Smith and Michaud 2004; Smith et al. 2005; Michaud et al. 2008).

However, the sentiments of Santa Barbara residents toward offshore oil and gas development are more complex than they may first appear. In an analysis of the results of a 1998 survey, Michaud et al. (2008) found that Santa Barbara residents were actually more supportive of oil development than people living elsewhere in the State—controlling for the other independent variables—because many believe that the risks do not pose a threat to humans. Bring Oil Back, a prominent Santa Barbara-based group founded several years ago as a direct challenge to GOO, counts among its members many self-described environmentalists who argue a range of issues to support their view: the improved safety record of the oil industry, the dangers of dependence on foreign oil, and the impact of revenue from increased oil production (Casselmann 2008).

In 2008, the Santa Barbara Planning Commission approved a controversial proposal to expand oil drilling from an offshore platform (Associated Press 2008). The commission voted 4-to-0 with one abstention to approve the Plains Exploration & Production Co. plan to tap a massive reserve potentially worth billions of dollars in the Santa Barbara Channel. In addition, three local environmental and conservation groups have agreed not to sue to block drilling if the company promises to shut down its local operation in 14 years, to fund projects that offset carbon dioxide emissions, such as low-emission public buses, and to donate thousands of acres of land to conservation causes (Associated Press 2008; Deturenne 2008). Also in 2008, in a highly publicized vote that took on national symbolic importance, the Santa Barbara County Board of Supervisors, on a 3-to-2 vote, authorized the County to send a letter to Governor Arnold Schwarzenegger requesting a repeal of the moratorium on offshore oil and gas leases (Barringer 2008; Santa Barbara County Board of Supervisors 2008). However, it is important to note that the Santa Barbara City Council expressed its disagreement with County Board’s decision by voting 5-to-1 to ratify a resolution in support of a State and Federal moratoria on new offshore oil and gas leasing off the Santa Barbara coastline (Pacheco 2008; Santa Barbara City Council 2008). This discord within Santa Barbara over offshore oil and gas development has been widely reported by the media (Barringer 2008; Foster 2008).

The evolving public opinion in Santa Barbara toward offshore oil development illustrates the thesis put forward by Gramling and Freudenburg (2006) and others that attitudes and perceptions

are influenced by a complex set of economic, political, biophysical, and social factors that shape the people and culture of a given place and time. A number of studies have applied this general thesis to historical analyses of oil development in Santa Barbara County (Lima 1994; Molotch and Freudenburg 1996; Nevarez et al. 1998; Sollen 1998; Paulsen et al. 2002), Ventura County (Paulsen et al. 1996), and San Luis Obispo County (Nevarez et al. 1996). Similarly, studies have contrasted the different paths of oil development in Santa Barbara and Ventura Counties (Adamson and Bergstrom 1998; Molotch et al. 2000; Adamson 2005; Adamson 2008).

Although there is a segment of California's population that remains opposed to the local presence of any aspect of the offshore oil and gas industry, some socioeconomic impacts of the industry appear to have diminished in importance. For example, while concern about the visual and aesthetic impacts of the above-water structures during oil and gas operations may have been an initial prominent reason for public objection to offshore drilling (Mineral Management Service 2001), there appears to be little concern today about these impacts. In fact, the four oil drilling platforms a quarter-mile off the Long Beach shore, which are camouflaged by waterfalls, brightly colored cement towers, and a landscape of shrubs and palm trees, all dramatically lighted at night, have become an icon of local "kitsch," still considered by some people to be ugly but enjoyed by others as part of the local color and a tourist attraction (Walters 2003; Schoch 2006). The original design drawings and photographs of the "oil islands" have been displayed at the University Art Museum at California State University, Long Beach (California State University-Long Beach 2006).

In addition, initial concerns about the "boom-bust cycle" often associated with extractive industries have been allayed as local oil-related firms adapt to declines in the oil industry in the Southern Study Area by diversifying into other realms (Molotch et al. 1998; Schmitt et al. 2003). Some economic offshoots are quite unexpected; for instance, one of the legacies of the oil industry is a burgeoning environmental consulting sector in the Santa Barbara area (Beamish and Paulsen 2000).

27.2 COMMERCIAL AND RECREATIONAL FISHERIES

The social conflict engendered by offshore oil and gas development in the Southern Study Area extends not only to the pre-lease and production stages of development, but also to the termination phase. Polarized views can be seen over the topic of decommissioning of obsolete offshore oil and gas processing facilities and sites (Schroeder and Love 2004). Several oil platforms in the Southern Study Area are expected to be decommissioned over the next few years, and all existing platforms are expected to cease production by 2025. Issues about the disposition of these platforms once decommissioned—that is, whether they are sunk offshore (typically referred to as the "rigs-to-reefs" option) or salvaged onshore—has become a highly contested issue (County of Santa Barbara Planning and Development Energy Division 2005), especially within the commercial and recreational fishing community.

Conflicts between commercial fisheries and offshore oil and gas operations in the Southern Study Area surfaced as early as the 1940's (USDOJ, MMS 2001). Potential conflicts include preclusion from fishing grounds, damage to or loss of fishing gear, and lethal and sub-lethal impacts to fish resources resulting from offshore oil and gas activities. While many of the

conflicts have been mitigated through oil and gas industry funding of programs, direct payment to fishermen for lost fishing opportunity and damaged or lost gear, and better communication, a number of commercial fishing organizations continue to be actively opposed to offshore drilling (Frumkes 2002). In 2008, for example, when there was a concerted push for more offshore drilling, the board of the Pacific Coast Federation of Fishermen's Associations reaffirmed its 30-plus years of opposition to offshore drilling (Grader and Spain 2008).

Trawlers are concerned that the rigs-to-reefs decommissioning option might result in lost platform materials that could damage their nets (Southern California Trawlers Association 1998). Further, platforms are a potential navigational hazard, and avoiding unmarked obstacles is difficult, even with the aid of modern navigational equipment (Frumkes 2002). Commercial fishers have allied themselves with anti-oil environmental activists who argue that leaving portions of platforms in the ocean constitutes “ocean dumping” (Athanasopoulos et al. 1999; Frumkes 2002). Moreover, complete removal of the platforms would serve as a “catharsis” for those California residents who have spent decades of fighting offshore oil and gas development (Camozzi 2007).

On the other hand, West Coast anglers have long enjoyed the fishing action around the oil platforms, which act as fish aggregating devices (Frumkes 1998; Curcione 2000). Leaving the platform structures in place would create artificial reefs that would continue to attract fish. It is also important to note that there are other proposed uses of decommissioned platforms, including converting them into experimental fish farms (Brown et al. 2004; Santa Barbara News-Press 2004a; Santa Barbara News-Press 2004b) or even offshore prisons (Wallace 2000). (See Schroeder and Love (2004) for other creative suggestions.)

The rigs-to-reefs concept could also represent a significant cost saving for oil production companies. Most of the facilities in California do not lend themselves to conventional decommissioning methods without heavy costs (Twachtman 1997). The commonly reported cost estimate of removing the remaining platforms is \$2.5 billion (Frumkes 2002). In addition, the potential cumulative impact of onshore disposal on public landfill capacity should be examined as part of the decommissioning process (Lima 1997).

In a 2001 State-funded survey of a sample of Californians, two of three respondents approved of turning offshore oil rigs into artificial reefs after production stops (Futch 2001). However, unlike states bordering the Gulf of Mexico, in California enhancement of recreational opportunities may be insufficient justification for the rigs-to-reefs initiative. The difference lies in societal perception of the oil industry, which, in turn, has been shaped by the distinct ecological and political contexts of the Gulf of Mexico and California (McGinnis et al. 2001; Frumkes 2002). Further discussion on the debate surrounding the conversion of oil rigs to artificial reefs, with focus on oil rigs near Santa Barbara, can be found in Rothback (2007) and Schroeder and Love (2004).

27.3 PUBLIC POLICY AND GOVERNANCE

The development of offshore oil and gas resources in the United States has been marked by extensive and recurrent conflict between the Federal government and the affected states and

localities. These conflicts, which began in the 1940s, have involved questions of resource ownership, management control, spillover effects on adjacent communities, and the distribution of benefits. The Federal-State conflict over offshore oil and gas development, referred to by some as the Seaweed Rebellion, has been the subject of a number of recent studies (Gramling 1996; Hershman 1996; Lester 1996; Fitzgerald 2000; Fitzgerald 2002; Fitzgerald 2004). The underlying source of the conflict is that the benefits of offshore energy development, which include increasing the domestic supply of energy, preserving jobs, generating Federal revenues, and reducing the trade deficit, are national in scope, while the costs of offshore energy development, such as adverse socioeconomic and environmental impacts are borne by the coastal states and communities (Fitzgerald 2002).

Fitzgerald (2004) provides a history of the conflicts between California and the Federal government regarding OCS energy development and analyzes the Ninth U.S. Circuit Court of Appeals decision in *State of California v. Gale Norton*. In that 2002 case, the Ninth Circuit upheld a district court decision that the California Coastal Commission has the authority under the Federal Coastal Zone Management Act to review an extension of offshore oil drilling leases that the Federal government granted to oil companies (*State of California v. Gale Norton* 2002). Over the years, the California Coastal Commission has voiced strong opposition to any new leasing of frontier areas of the California coast for oil and gas extraction.

More recently, the issue of the availability of OCS lease areas off the California coast has provoked statements of opposition to offshore oil and gas development from most of the State's top political leaders, as well as from representatives of both of the State's U.S. Senators and 23 members of Congress. In 2008, for example, Assembly Joint Resolution 51 expressed the California State Legislature's opposition to any new Federal energy policy legislation that opens up the California, Oregon, and Washington coasts to offshore oil drilling (California State Legislature 2008), and in a 2006 letter to Acting Secretary of the Interior, Governor Arnold Schwarzenegger reaffirmed his long-held support for a Federal moratorium prohibiting new leases and exploration for oil and gas off the California Coast (California Office of the Governor 2006). Similarly, California Congressman Mike Thompson criticized a draft Bush Administration proposal to open up 2 million acres off the coast of Mendocino for oil exploration in 2014, and in early 2009, Congressman Thompson introduced legislation that would permanently prohibit oil and gas drilling off the coasts of Mendocino, Humboldt, and Del Norte Counties (Thompson 2009). However, other California legislators, such as Congressman Richard Pombo, have supported drilling for oil and gas off the coast of California (Coile 2005).

Another area of Federal-State conflict involves the Federal revenues from offshore leases that are statutorily allocated among certain coastal states and other government accounts. California and other states with oil and gas development off their shores in Federal waters have been seeking a larger portion of the Federal revenues generated in those areas. They particularly want more assistance for coastal areas that may be most affected by onshore and near-shore activities that support offshore oil and gas development (Humphries 2008). The Gulf of Mexico Energy Security Act of 2006 expanded revenue sharing for only four Gulf States—Alabama, Mississippi, Louisiana, and Texas.

The issue of revenue sharing has been complicated by the aforementioned allegations of mismanagement and corruption aimed at the Federal program for collecting oil and gas royalties. In California, much of the controversy has centered on the system of valuation of oil produced from Federal leases. This high-profile issue for the Bureau of Ocean Energy Management, Regulation, and Enforcement and oil and gas industry involved as much as \$2 billion nationwide in royalties shared by Federal and State government (U.S. Congress 1996). In 1996, an interagency task force assembled by the U.S. Dept. of the Interior concluded that the major oil companies' use of posted prices in California to calculate Federal royalties was inappropriate and recommended that the Federal oil valuation regulations be revised (Interagency Task Force 1996; U.S. General Accounting Office 1998). According to reports by the public interest group, Project on Government Oversight (1995; 1996), the valuation system resulted in the loss of millions of dollars of royalties for California; this loss had negative implications for the State's public schools, as California law requires all royalties be credited to the State Schools Fund.

In response to the criticism of oil valuation standards, the Bureau of Ocean Energy Management, Regulation, and Enforcement (BOEMRE) undertook two major oil valuation rulemakings leading to promulgation of regulations, in 2000 and again in 2004, that significantly changed oil valuation and withstood legal challenge. In 2007, a report issued by the Subcommittee on Royalty Management (2007) recommended further changes to aspects of royalty management activities administered by BOEMRE to ensure public confidence. In addition, the Justice Department has reached settlements with oil companies of approximately \$440 million to resolve claims of underpayment of oil royalties (U.S. Dept. of Justice 2001).

27.4 ADDITIONAL AREAS OF SOCIAL, CULTURAL, AND ECONOMIC INTEREST

There is a wide range of other areas of social, cultural, and economic interests to be considered in environmental assessments of offshore oil and gas installations. Because these areas have not been addressed in detail during this literature synthesis, they are briefly described below, together with information needs for identifying and describing potential impacts.

27.4.1 Economic Development

The total number of jobs created from any new offshore oil and gas development in the Southern Study Area is one of the first things the State or an adjacent county will ask about. Particularly attractive are the generally high wages earned by oil and gas industry workers. For example, the average worker in the oil and gas industry worker in the Tri-County Area (Santa Barbara, Ventura, and San Luis Obispo) typically earns approximately eighty-seven percent more than the average worker in the Area (USDIO, MMS 2001).

In addition to direct employment impacts, employment may be indirectly fostered through secondary economic effects, including indirect impacts (e.g., changes in interindustry purchasing patterns) and induced impacts (e.g., changes in household spending patterns). Input-output models, such as IMPLAN, an economic input-output software package and data set developed by MIG, Inc., can be used to estimate total job creation including multiplier impacts of a proposed project at different scales. The IMPLAN input-output model also provides other measures of economic activity, such as output (dollars' worth of production) and regional income (the sum of worker wages and salaries plus business income and profits).

The IMPLAN model as received from the vendor may not accurately reflect the offshore oil and gas production sector for a particular area. To model a specific industry, IMPLAN can be recalibrated, i.e., new first-round input requirements for the various stages of oil and gas exploration and development can be developed. For example, to determine the economic effects of the offshore gas industry on Mobile County, the rest of Alabama, and the combined economies of Louisiana and Texas, Plater et al. (2000) developed an IMPLAN input-output model specific to Coastal Alabama and Destin Dome OCS exploration, development, and production. The IMPLAN results combined with estimates of industry expenditures on offshore gas development drove a spreadsheet model that estimated the impacts on employment, population, and personal income resulting from the Coastal Alabama offshore gas industry.

In addition, in the late 1990s, BOEMRE developed a new framework for estimating regional economic impacts that recognizes regional differences but provides for a consistent approach to the development of models for all coastal areas and for different levels of analysis (Coffman et al. 2009; Dismukes et al. 2003). Contractors for the BOEMRE subsequently created the MAG-PLAN (MMS Alaska-Gulf of Mexico Modeling using IMPLAN) economic model, a Microsoft ACCESS-based, 2-stage input-output model using IMPLAN multipliers, to estimate employment, personal income, and similar economic impacts from OCS activities. In the broadest terms, MAG-PLAN consists of two stages and requires an Exploration & Development (E&D) scenario to run. E&D scenarios are estimates of the oil-and-gas-related activities that are likely to occur as the result of a proposed action such as a lease sale or collection of lease sales. The first stage of MAG-PLAN estimates the level of spending (by sector and location), and the second stage uses IMPLAN multipliers to convert the spending into estimates of employment, personal income, etc. (Coffman et al. 2009).

27.4.2 Infrastructure and Services

There are large port facilities along the coast of the Southern Study Area that could provide necessary construction support for offshore oil and gas development. Consequently, it is expected that any impacts to port and transportation systems would be negligible to minor.

27.4.3 Transportation and Navigation

Depending on the location, number, and array of platforms installed, offshore oil and gas development facilities could potentially conflict with the rights of navigation enjoyed by marine users. An assessment must be conducted to determine if areas selected for development impact existing water navigation or transportation routes.

Collection of marine traffic data in the vicinity of a proposed project could include current activity by military craft (Navy and Coast Guard); commercial business craft (freighters, tug boats, fishing vessels, ferries, and cruise passenger ships); commercial recreational craft (cruise ships and fishing/sight-seeing charters); research vessels; and personal craft (fishing boats, house boats, yachts, and other pleasure craft). Possible data sources of marine traffic in the vicinity of a proposed project include Vesseltracker.Com (2009). Information on the types of navigation hazards that offshore oil and gas development may pose is available from collision incident data collected by the Minerals Management Service (2008).

Impacts to commercial and recreational boating would be addressed through a full navigation risk assessment, often coordinated with the U.S. Coast Guard. Tuholski et al. (2002) describe a standard approach to risk assessment that seeks to identify hazards as sources of risks and then examines how the hazards might give rise to accidents. Accidents are categorized both in terms of the severity of their effects (i.e., consequences in terms of harm to people or the environment, damage to assets, and other economic losses) and the likelihood of the harm occurring. In addition, mitigation measures to reduce risks to more acceptable levels are identified.

27.4.4 Recreation and Tourism

The main recreation and tourism activities that could be affected by construction and operation of an offshore oil and gas facility would be sightseeing, diving, and recreational fishing. The extent of impacts would depend on the proximity of offshore oil and gas facilities and activities to recreational use areas. These impacts can be negative, such as increased vessel traffic, exclusion areas, and visual effects, and positive, such as enhanced recreational fishing opportunities for certain species that are attracted by the introduction of hard substrates.

Information needs to describe direct and indirect impacts to recreational fishing within the footprint of an offshore oil and gas installation are discussed in [Section 27.5.2](#). The most significant potential for adverse effects on both tourism and recreational areas may be from visual effects of the project. Thus, the visualization impact analysis described in [Section 27.5.1](#) will be an important component of an environmental assessment.

Coastal and beach recreation and associated tourism could be temporarily affected by offshore oil and development activity if campground facilities are used as temporary housing sites for immigrant construction workers, or beaches or campgrounds are closed due to offshore to onshore pipeline construction (USDOJ, MMS 2001). Effects to recreation and tourism would be location specific and may vary seasonally. If these disruptions occurred to a heavily used coastal area during the summer, which is the peak season for beach recreation and tourism, the result could be substantial economic losses.

An oil spill from OCS production could have temporary and long-term effects on coastal and beach recreation and associated tourism by changing use patterns (USDOJ, MMS 2001). Depending on the size of the oil spill, it could result in partial or complete closure of water-oriented recreational facilities. Moreover, there may be a perceptually degraded period when the beach is physically clean yet the memory of the accident is fresh enough that the quality of the experience may be somewhat degraded. Effects to recreation and tourism would be location specific and may vary seasonally. Should such disruptions occur to a heavily used coastal area during the summer, which is the peak season for beach recreation and tourism, the result could be substantial economic costs.

27.4.5 Safety and Lifestyle

The nature of offshore oil and gas development—extraction of volatile substances sometimes under extreme pressure in a hostile environment—means accidents occasionally occur. Incidents such as the 2004 leak of flammable natural gas and toxic hydrogen sulfide which led to the

evacuation of 39 workers from an oil platform off Ventura County underscore the occupational dangers of offshore oil and gas development (Kelley 2004; Kelley 2005). The U.S. Coast Guard, as well as other maritime organizations, has reported that human error has a significant impact on the operation of offshore oil facilities (Bmt Designers & Planners 2007). Attendees at the first International Workshop on Human Factors in Offshore Operations noted the need to review past, current, and future actions to lower the risk and the number of human factors related to possible incidents in offshore operations (International Workshop on Human Factors in Offshore Operations 1996). The 2002 workshop brought together six key work groups to develop a set of guidelines, tools, and references to reduce risk and improve safety and production performance (Second International Workshop on Human Factors in Offshore Operations 2002).

Despite the dangers and other drawbacks of offshore oil and gas employment, such as long periods away from home, many individuals find the work rewarding and personally satisfying. One attraction, of course, is the level of compensation—in recent years there has been a shortage of qualified individuals in the oil and gas industry, thus companies are offering generous salaries and fringe benefits to attract and retain employees (Showalter 2005). However, it is also the challenging lifestyle that many women as well as men accept and embrace (Haldane 1999; Romo 2000; Kelly 2001; Shrimpton and Storey 2001).

Under authority established in the Outer Continental Shelf Lands Act of 1953, as amended, and pursuant to a memorandum of understanding between the two agencies, the BOEMRE and Coast Guard regulate safety on fixed OCS facilities. BOEMRE regulates the structural integrity of fixed OCS facilities, and USCG regulates marine systems, such as lifesaving, navigation equipment, and workplace safety and health. In February 2002, the USCG issued a final regulation that authorized the BOEMRE to perform inspections on fixed facilities engaged in OCS activities on their behalf and to enforce USCG regulations applicable to those facilities. The Outer Continental Shelf Lands Act also requires that the BOEMRE and Coast Guard investigate major accidents, deaths, serious injuries, major fires, and major spillages, as well as lesser accidents.

27.4.6 Military Use Areas

Offshore oil and gas facilities would vary in size and location, but may be large enough to create a substantial exclusion area for military uses. A number of recent articles have discussed the controversy surrounding the compatibility of offshore oil and gas drilling with military missions in the Gulf of Mexico (Associated Press 2005; Goode 2005; Hogg 2008). However, impacts to military operations are expected to be negligible as long as developments are coordinated with the U.S. Department of Defense.

27.5 AVAILABLE INFORMATION & DATA GAPS

27.5.1 Visual Resources and Aesthetics

Depending on the proximity of proposed offshore oil and gas development to the coastline, impacts on seascapes may be an initial prominent reason for public objection, especially for large, manned platform facilities. Both construction and operation of an offshore oil and gas facility could potentially cause visual impacts. Visual impacts associated with the development

of offshore oil and gas facilities include the presence of the drilling platforms, navigational lighting on the platforms, and marine vessels and helicopters for maintenance activities.

Description of the visual resources potentially affected by proposed facilities involves establishing landscape types and scenic quality in the areas in which platform facilities would be located, followed by an assessment of the potential sensitivity to changes in the visual environment, including the likely number of viewers. Visual impact assessments will need to be conducted for selected viewpoints that include historic properties and onshore recreational sites (mostly beaches) and offshore sites. These assessments should include field surveys to collect information on seascape quality, sensitivity, value, and capacity to accommodate change of these viewpoints. In addition, computer-generated simulations and photomontages can illustrate how the facility would appear under different conditions. Guidance documents (Department of Trade and Industry 2005; National Research Council 2007) that have been developed on how to address seascape and visual impacts during environmental reviews for offshore wind parks would also be applicable to offshore oil and gas development.

27.5.2 Commercial and Recreational Fisheries

A potential impact of offshore oil and gas development is the creation of space-use conflicts with commercial and recreational fisheries. The significance of space-use conflicts can be assessed, in the case of commercial fisheries, by examining the spatial and temporal nature of typical fishing activities. Databases maintained by the Pacific States Marine Fish Commission (PSMFC) are useful in this respect. The Pacific Fisheries Information Network (PacFIN) provides timely and accurate data essential for effective fisheries management. The PacFIN central database includes fish-ticket and vessel registration data provided by the Washington, Oregon, and California State fishery agencies. In addition, State fishery agencies supply species catch composition and catch by area proportions that are developed from their port sampling and trawl logbook data systems. Groundfish catches are supplied by species, gear type, and area. Ex-vessel per-pound prices are provided also by species and gear type along with revenue estimates. The spatial resolution of these data is typically the geographical management unit. Finer spatial resolution, 10-by-10-degree blocks, subject to confidentiality constraints, can be obtained by submitting a custom data request to the PacFIN database manager. The Fisheries Economics Data Program, also maintained by the PSMFC, is useful in conducting such an assessment because it is responsible for conducting annual industry cost and effort surveys.

The West Coast Groundfish Observer Program, operated by the National Marine Fisheries Service (NMFS) Northwest Fisheries Science Center, places observers on commercial fishing vessels to monitor and record catch data, including species composition of retained and discarded catch. The objective of this program is the provision of accurate accounts of total catch, bycatch, and discards associated with different fisheries and fish stocks.

Taken together, the above data sources facilitate evaluation of the potential impacts of offshore oil and gas development on commercial fisheries. While these data sets contain extensive information on catch, there are limited data on fishing effort, catch per unit of effort and harvesting costs both spatially and temporally. Research to address these data deficiencies would improve the ability to evaluate the impacts of energy-related activities.

With respect to recreational fisheries, spatial conflicts can be assessed using the Pacific Recreational Fisheries Information Network (RecFIN) database. California and NMFS contribute to the database maintained by the PSMFC. RecFIN is designed to integrate State and Federal marine recreational fishery sampling efforts into a single database that provides data on catch, effort, economics, and fisher demographics. To meet the objectives of the program, the California Department of Fish and Game conducts an onsite survey of effort and an access-point intercept survey for catch per unit of effort data. Other survey methods include a license-based angler directory telephone survey of effort, an onsite survey of pier/dock fishing, and access-point intercept surveys to collect catch per unit of effort data from angler and boat operators.

The Marine Recreational Fisheries Statistics Survey (MRFSS) generates independent estimates of effort and catch through two separate survey components, a bimonthly household telephone survey, and a continuous onsite, access-point intercept survey of angler fishing trips. RecFIN expands on this coast-wide overview of marine recreational catch and effort to incorporate all State and Federal sampling programs into an integrated system. In the Pacific MRFSS, an average of 40,000 anglers is interviewed each year at fishing sites upon completion of their trip. Data on species caught, lengths and weights, various demographics and trip activity data and economic data are collected from each angler. About six separate State data collection projects are conducted, with sampling levels up to 20 percent of the angler trips targeted on specific fisheries and fishing modes in specific areas. These State data are integrated with MRFSS data by RecFIN to provide coast wide marine recreational catch and effort data for use by State and Federal fishery agencies and the public. As with the PacFIN data, finer resolution data sets can be obtained from the RecFIN database manager.

Environmental Impact Statements and Environmental Assessments produced for Pacific Fishery Management Council management proposals contain a wealth of information that can be used, when coupled with the databases discussed above, to support the assessment of offshore oil and gas development projects. While there is an abundance of spatial and temporal catch information in the environmental reviews prepared by the Council and NMFS, catch per unit of effort and cost information is sparse. This deficiency limits the use of these documents in examining potential fisheries impacts of offshore oil and gas development.

A tool that may be useful for data collection and analysis is Open OceanMap, developed by Ecotrust. Using a web-based interface, Open OceanMap allows analysts to collect and compile ecological and economic data through an intuitive stakeholder interview process (Ecotrust 2009). The survey results can then be incorporated into spatial and economic analyses. Ecotrust used this geographic information system technology to help to estimate potential fishery impacts of proposed marine protected area networks developed in California's Marine Life Protection Act process (Scholz et al. 2008; Steinback & Kruse 2009).

27.6 LIST OF LITERATURE CITED—SOCIOECONOMIC IMPACTS

Adamson, M. 2005. The Cultural Context of Oil Development in California's Coastal Region: Contrasting Community Responses During the Exuberant Era, Workshop on Socioeconomic Research Issues for the Gulf of Mexico OCS Region, February 2004, New Orleans, LA.

U.S. Dept. of the Interior, Minerals Management Service, Gulf of Mexico OCS Region. OCS Study MMS 2005-016.

- Adamson, M. 2008. Oil booms and boosterism. *Journal of Urban History* 35(1):150-177.
- Adamson, M. and R. Bergstrom. 1998. Exploration and production in Ventura, Santa Barbara, and San Luis Obispo Counties, California: Oil well operators, 1950-1997. U.S. Dept. of the Interior, Minerals Management Service, Pacific OCS Region, Santa Barbara, CA. OCS Study MMS 98-0061.
- Andrews, E. 2006. Vague law and hard lobbying add up to billions for big oil. *The New York Times*. March 27:New York, NY. http://www.nytimes.com/2006/03/27/business/27royalties.html?_r=1&ref=business&pagew.
- Andrews, E. 2007. Inspector finds broad failures in oil program. *The New York Times*. September 26:New York, NY. <http://www.nytimes.com/2007/09/26/business/26oil.html?scp=1&sq=%22Inspector%20Find%20Broad%20Failures%20in%20Oil%20Program%22&st=cse>
- Associated Press. 2005. Offshore drilling is incompatible with military missions in Gulf of Mexico. *Alexander's Gas & Oil Connections*. December 22: <http://www.gasandoil.com/goc/news/ntn55182.htm>.
- Associated Press. 2008. Santa Barbara County planners approve offshore oil expansion. <http://www.sanluisobispo.com/178/story/339425.html>. September 23, 2008.
- Athanassopoulos, J., J. Dalton and A. Fischer. 1999. Offshore oil platform decommissioning: A comparative study of strategies and the ecological, regulatory, political and economic issues involved in decommissioning planning. Master's Thesis, University of California, Santa Barbara.
- Baldassare, M. 2002. PPIC Statewide Survey: Special Survey on Californians and the Environment. Public Policy Institute of California. San Francisco, CA.
- Baldassare, M., D. Bonner, J. Paluch and S. Petek. 2008. PPIC Statewide Survey: California & the Environment. Public Policy Institute of California. San Francisco, CA.
- Barringer, F. 2008. California County's resolve against drilling fades. *The New York Times*. August 26:New York, NY. <http://www.nytimes.com/2008/08/27/us/27drill.html>
- Beamish, T. . Accumulating trouble: Complex organization, a culture of silence, and a secret spill. *Social Problems* 47(4):473-498.
- Beamish, T. 2001. Environmental hazard and institutional betrayal: Lay-public perceptions of risk in the San Luis Obispo County oil spill. *Organization & Environment* 14(1):5-33.
- Beamish, T. 2002a. *Silent spill*. Cambridge, MA: MIT Press.

- Beamish, T. 2002b. Waiting for crisis: Regulatory inaction and ineptitude and the Guadalupe Dunes oil spill. *Social Problems* 49(2):150-177.
- Beamish, T. and K. Paulsen. 2000. The Santa Barbara Channel Post-Petroleum Economy: Environmental Consulting Proliferates, California Islands Symposia Compendium, MBC Environmental Sciences. 5:
- Birkland, T.A. 1997. After disaster: agenda setting, public policy, and focusing events. Washington, DC: Georgetown University Press.
- Birkland, T.A. 2000. Focusing events, mobilization, and agenda setting. *Journal of Public Policy* 18(1):53-74.
- Bmt Designers & Planners. 2007. Human Factors Engineering Success Stories in the Oil and Gas Industry. Arlington, VA,
- Brand, M. 2008. Released Lessons learned from Santa Barbara spill. National Public Radio. 2008.
- Bridgers, J. 2007. Coast doesn't thrive well when oil and water mix. *Ventura County Star*. January 7:Camarillo, California. <http://nl.newsbank.com/nl-search/we/Archives>.
- Brown, D. 2008. Why we should drill offshore. *Marin Independent Journal*. August 18:Novato, CA. http://www.marinij.com/marinnews/ci_10235145?IADID=Search-www.marinij.com-www.marinij.com.
- Brown, J., M. Mccorkle, Z. Grader, D.M. Skladany and B. Bolton. 2004. Is our government outsourcing fishermen's jobs to offshore rigs and deepsea cages? *Fishermen's News*. March:San Francisco, CA. <http://www.pcffa.org/fn-mar04.htm>.
- California Office of the Governor. 2006. Gov. Schwarzenegger Continues Fight to Protect California's Coastline. GAAS:228:06.
- California State Legislature. 2008. Assembly Joint Resolution 51: Opposing Lifting of Offshore Oil Moratorium.
- California State University-Long Beach, University Art Museum. 2006. Fantasy islands: Landscaping Long Beach's oil platforms. UAM CSULB News. Long Beach, CA. http://csulb.edu/org/uam/PDF_files/PDF_exhibition_files/UAM_Fantasy_Islands_2.pdf.
- Camozzi, N. 2007. Platform Abandonment and the Santa Barbara Channel. In: Manago, F. and B. Williamson. *Proceedings: Public Workshop, Decommissioning and Removal of Oil and Gas Facilities Offshore California: Recent Experiences and Future Deepwater Challenges*. Santa Barbara, CA: Coastal Research Center, Marine Science Institute, University of California.

- Casselman, B. 2008. California county weighs push for offshore drilling. *The Wall Street Journal*. August 22:New York, NY. <http://online.wsj.com/article/SB121936878285762399.html>
- Clarke, K. and J. Hemphill. 2002. The Santa Barbara oil spill: A retrospective. In: Danta, D. *Yearbook of the Association of Pacific Coast Geographers*. Honolulu, HI: University of Hawai'i Press.
- Coffman, K., V. Zatarain and S. Gambino. 2009. *The New Regional Economic Impact Modeling Approach for the U.S. Minerals Management Service*.
- Coile, Z. 2005. Pombo proposes lifting offshore drilling moratorium. *San Francisco Chronicle*. October 7: San Francisco, CA. <http://www.sfgate.com/cgi-bin/article.cgi?f=/c/a/2005/10/07/MNG6MF3SU11.DTL&hw=p>.
- County of Santa Barbara Planning and Development Energy Division. 2005. *Historic overview of the Energy Division: The third decade-Looking Forward (2002-2011)*. <http://www.countyofsb.org/energy/who/divHistory3rd.asp>.
- Cruickshank, R. 2008. Santa Maria Wingnuts seek to destroy Santa Barbara's economy. December 12, 2008. <http://www.calitics.com/showDiary.do?diaryId=6762>.
- Curcione, N. 2000. California oil rig strategies. An in-depth guide to fly fishing California offshore towers. Fly fishing in salt waters. January 28, 2009. <http://www.flyfishinsalt.com/travel/west-coast/california-oil-rig-strategies-32186.html>.
- Department of Trade and Industry, United Kingdom. 2005. *Guidance on the Assessment of the Impact of Offshore Wind farms: Seascape and Visual Impact Report*.
- Deturenne, V. 2008. Texas oil company dangles (many, many) carrots in bid for offshore drilling lease. *Los Angeles Times*. April 11:Los Angeles, CA. <http://latimesblogs.latimes.com/lanow/2008/04/state-says-yes.html>
- Dismukes, D., W. Olatubi, D. Mesyanzhinov and A. Pulsipher. 2003. *Modeling the economic impacts of offshore oil and gas activities in the Gulf of Mexico: Methods and applications*. New Orleans, LA. OCS Study MMS 2003-018.
- Ecotrust. 2009. *Open OceanMap*. December 18, 2009. <http://www.ecotrust.org/ocean/OpenOceanMap.html>.
- Fitzgerald, E. 2000. *The Seaweed Rebellion: Federal-State conflicts over offshore energy development*. Lanham, MD: Lexington Books.
- Fitzgerald, E. 2002. *The Seaweed Rebellion: Florida's experience with offshore energy development*. *Journal of Land Use* 8(1):1-73.

- Fitzgerald, E. 2004. California Coastal Commission v. Norton: A coastal state victory in the Seaweed Rebellion. *UCLA Journal of Environmental Law and Policy* 22:155-235.
- Foster, J. 2008. Oil at what price? Offshore drilling on S.B. coast gets mixed reviews. *Santa Barbara News-Press*. June 19:Santa Barbara, CA. <http://www.newspress.com/Top/Article/article.jsp?Section=LOCAL&ID=565318005920235588&Archive=true>.
- Freudenburg, W.R. and R. Gramling. 2002. How crude: Advocacy coalitions, offshore oil, and the self-negating belief. *Policy Sciences* 35(1):17-41.
- Frumkes, D. 1998. United Anglers of Southern California/American Sportfishing Association perspective. In: Manago, F. and B. Williamson. *Proceedings: Public Workshop, Decommissioning and Removal of Oil and Gas Facilities Offshore California: Recent Experiences and Future Deepwater Challenges*. Santa Barbara, CA: Coastal Research Center, Marine Science Institute, University of California.
- Frumkes, D. 2002. The status of the California Rigs-to-Reefs Programme and the need to limit consumptive fishing activities. *ICES Journal of Marine Science* 59(Supplement):S272-S276.
- Futch, J. 2001. Changing oil rigs to reefs supported. *Press-Telegram*. February 9:Long Beach, CA. <http://nl.newsbank.com/nl-search/we/Archives>.
- Goode, D. 2005. Nelson raises defense issues in offshore drilling fight. *CongressDaily*. October 24: Washington, D.C. <http://web.ebscohost.com.proxy.library.oregonstate.edu/ehost/delivery?vid=9&hid=103&s>.
- Grader, Z. and G. Spain. 2008. Offshore drilling--It's back "drill, baby drill," really burn, baby burn for fisheries. *Fishermen's News*. November:San Francisco, CA. <http://www.pcffa.org/fn-nov08.htm>.
- Gramling, R. 1996. *Oil on the edge: Offshore development, conflict, gridlock*. Albany, NY: State University of New York Press.
- Gramling, R. and W.R. Freudenburg. 2006. Attitudes toward offshore oil development: A summary of current evidence. *Ocean and Coastal Management* 49(7-8):442-461.
- Haldane, D. 1999. Beauty and the beast. *Los Angeles Times*. June 29:Los Angeles, CA. <http://articles.latimes.com/1999/jan/29/news/mn-2866>.
- Hershman, M. 1996. Ocean management policy development in subnational units of government: examples from the United States. *Ocean and Coastal Management* 31(1):25-40.
- Hogg, J. 2008. Military complicates drilling: Eastern waters off limits because of Air Force, Navy use. *The News Herald*. July 20:Panama City, FL. <http://web.ebscohost.com.proxy.library.oregonstate.edu/ehost/delivery?vid=8&hid=103&s>.

- Hoyt, C. 1995. Myth of the black goo. The San Diego Union-Tribune. August 10:San Diego, CA. <http://nl.newsbank.com/nl-search/we/Archives>.
- Humphries, M. 2008. Outer Continental Shelf: Debate Over Oil and Gas Leasing and Revenue Sharing. Congressional Research Service. Washington, D.C.
- Interagency Task Force. 1996. Final Interagency Report on the Valuation of Oil Produced from Federal Leases in California. Prepared for the Assistant Secretary, Land and Minerals Management and the Director of the U.S. Dept. of the Interior, Minerals Management Service.
- International Workshop on Human Factors in Offshore Operations. 1996. 1996 International Workshop on Human Factors in Offshore Operations. New Orleans, LA: American Bureau of Shipping.
- Kahn, C. 2008. Released Debating 'drill, baby, drill' at site of '69 spill. National Public Radio. 2008.
- Kelly, D. 2001. Oil Rig, 9 miles offshore, Is home and work above the sea. Los Angeles Times. May 21:Los Angeles, CA. <http://articles.latimes.com/2001/may/27/local/me-3292>
- Kelley, D. 2004. 39 evacuated off oil platform. Los Angeles Times. November 19:Los Angeles, CA. <http://articles.latimes.com/2004/nov/19/local/me-evacuate19>.
- Kelley, D. 2005. Errors led to leak on oil platform. Los Angeles Times. February 19:Los Angeles, CA. <http://articles.latimes.com/2005/feb/19/local/me-vnplatform19>
- Kildow, J. and C. Colgan. 2005. California's Ocean Economy. Report to the Resources Agency, State of California. Prepared by The National Ocean Economics Program. July 2005.
- King, P. 1999. The Fiscal Impact of Beaches in California. Public Research Institute, San Francisco State University. San Francisco, CA.
- King, P. and M. Potepan. 1997. The Economic Value of California's Beaches. San Francisco, CA: Public Research Institute, San Francisco State University.
- Leeworthy, V., A. Edwards, E. Stone, N. Meade and L. Pendleton. 2007. Southern California Beach Recreation Valuation Project: Summary. National Oceanic and Atmospheric Administration, National Ocean Service Special Projects. Silver Spring, MD.
- Leeworthy, V. and P. Wiley. 2007. Economic Value and Impact of Water Quality Change for Long Beach in Southern California. National Oceanic and Atmospheric Administration, National Ocean Service Management and Budget Office. Silver Spring, MD.
- Lester, C. 1996. Reforming the offshore oil and gas program: rediscovering the public's interests in the outer continental shelf lands. Ocean and Coastal Management 30(1):1-42.

- Lew, D. and D. Larson. 2005. Valuing recreation and amenities at San Diego County beaches. *Coastal Management* 33(1):71-86.
- Lima, J. 1994. The politics of offshore energy development. Ph.D. Dissertation, University of California, Santa Barbara.
- Lima, J. 1997. Long-term Socio-economic Effects of Onshore Facility Decommissioning. In: Manago, F. and B. Williamson. Proceedings: Public Workshop, Decommissioning and Removal of Oil and Gas Facilities Offshore California: Recent Experiences and Future Deepwater Challenges. Santa Barbara, CA: Coastal Research Center, Marine Science Institute, University of California.
- Mara, J. 2008. Offshore oil drilling comes back to the surface. *Contra Costa Times*. June 30:San Francisco, CA. <http://nl.newsbank.com/nl-search/we/Archives>.
- Mcginnes, M. 2005. Santa Barbara blowout was a call to action. *Santa Barbara News-Press*. January 23:Santa Barbara, CA. <http://www.newspress.com/Top/Article/article.jsp?Section=ARCHIVESW&ID=564387716003921998&Archive=true>.
- Mcginnis, M., L. Fernandez and C. Pomeroy. 2001. The politics, economics, and ecology of decommissioning offshore oil and gas structures. Coastal Research Center Marine Science Institute, University of California. Santa Barbara, CA. MMS OCS Study 2001-006.
- Mcguire, B. 2008. Coastal oil drilling: the time has come for careful development in California waters. *The San Diego Union-Tribune*. August 10:San Diego, CA. <http://nl.newsbank.com/nl-search/we/Archives>.
- Michaud, K., J. Carlisle and E. Smith. 2008. Nimbyism vs. environmentalism in attitudes toward energy development. *Environmental Politics* 17(1):20-39.
- Molotch, H. and W. Freudenburg. 1996. Santa Barbara County: Two Paths. U.S. Dept. of the Interior, Minerals Management Service, Pacific OCS Region, Camarillo, CA. OCS Study MMS 96-0036.
- Molotch, H., W. Freudenburg and K. E. Paulsen. 2000. History repeats itself, but how? City character, urban tradition, and the accomplishment of place. *American Sociological Review* 65(6):791-823.
- Molotch, H., J. Woolley and T. Jori. 1998. Growing firms in declining fields: Unanticipated impacts of oil development. *Society and Natural Resources* 11(2):137-156.
- Morrill, C. and J. Owen-Smith. 2001. The emergence of environmental conflict resolution subversive stories, institutional change, and the construction of fields. In: Ventresca, M. and A. Hoffman. Organizations, policy, and the natural environment: Institutional and strategic perspectives. Stanford, CA: Stanford University Press.

- National Research Council. 2007. Environmental Impacts of Wind-Energy Projects.
- Nevarez, L. 1996. Just wait until there's a drought: Mediating environmental crisis for urban growth. *Antipode* 28 (3): 246-272.
- Nevarez, L., H. Molotch and W. Freudenburg. 1996. San Luis Obispo County: A major switching. U.S. Dept. of the Interior, Minerals Management Service, Pacific OCS Region. Camarillo, CA. OCS Study MMS 96-0037.
- Nevarez, L., H. Molotch, P. Shapiro and R. Bergstrom. 1998. Petroleum extraction in Santa Barbara County, California: An industrial history. U.S. Dept. of the Interior, Minerals Management Service, Pacific OCS Region, Camarillo, CA. OCS Study MMS 98-0048.
- Pacheco, A. 2008. City council votes against oil drilling-Symbolic gesture supports state, federal bans on new offshore leases. Santa Barbara News-Press. September 11: Santa Barbara, CA. <http://www.newspress.com/Top/Article/article.jsp?Section=LOCAL&ID=565366384431857748&Archive=true>.
- Paulsen, K., H. Molotch and W. Freudenburg. 1996. Ventura County: oil, fruit, commute, and commute. U.S. Dept. of the Interior, Minerals Management Service, Pacific OCS Region, Camarillo, CA. OCS Study MMS 96-0035.
- Paulsen, K., H. Molotch and W. Freudenburg. 2002. Data happen, but how? *American Sociological Review* 67(6):917-924.
- Plater, J., J. Kelley, W. Wade and R. Mott. 2000. Economic effects of coastal Alabama and Destin Dome offshore natural gas exploration, development, and production. U.S. Dept. of the Interior, Minerals Management Service, Gulf of Mexico Region. New Orleans, LA. OCS Study MMS 2000-044.
- Preston, B. 2008. Thousand-gallon spill in Santa Barbara waters. *The Santa Barbara Independent*. September 11: Santa Barbara, CA. <http://www.independent.com/news/2008/dec/11/thousand-gallon-spill-santa-barbara-waters/>.
- Project on Government Oversight. 1995. Department of Interior Looks the Other Way: The Government's Slick Deal for the Oil Industry. Washington, D.C.,
- Project on Government Oversight. 1996. With A Wink And A Nod: How the Oil Industry and the Department of Interior Are Cheating the American Public and California School Children. Washington, D.C.,
- Public Policy Institute of California. 2003. It's A beach state...of mind: Despite tumultuous times, California's Golden Coast still captures hearts. Press Release. April 1, 2009. <http://www.ppic.org/main/pressreleaseindex.asp>.

- Resources Agency of California. 1997. California's Ocean Resources: An Agenda for the Future. Ocean Resources Management Program, The Resources Agency of California. Sacramento, CA.
- Romo, J. 2000. Women on the rigs: A gender accomplishment. Master's Thesis, University of California, Santa Barbara.
- Rothback, D. 2007. Rigs to reefs: Refocusing the debate in California. Duke Environmental Law and Policy Forum 17:283-295.
- Santa Barbara City Council. 2008. Federal Moratorium On Offshore Oil Leases. Santa Barbara City Council. Santa Barbara, CA
- Santa Barbara County Board of Supervisors. 2008. Energy Crisis. Santa Barbara County Board of Supervisors. Santa Barbara, CA.
- Santa Barbara News-Press. 2004a. Fish farms offshore? Santa Barbara News-Press. August 24:Santa Barbara, California.
<http://www.newspress.com/Top/Article/article.jsp?Section=ARCHIVESW&ID=564229918905466928&Archive=true>
- Santa Barbara News-Press. 2004b. Fish farm proposed for old oil platform. Santa Barbara News-Press. February 14:Santa Barbara, CA.
<http://www.newspress.com/Top/Article/article.jsp?Section=ARCHIVESW&ID=564229918905466928&Archive=true>
- Savage, C. 2002. Sex, drug use and graft cited in Interior Department. The New York Times. September 11:New York, NY.
<http://www.nytimes.com/2008/09/11/washington/11royalty.html?pagewanted=print>
- Schmitt, R., J. Dugan and M. Adamson. 2003. Industrial activity and its socioeconomic impacts: Oil and three coastal California counties. U.S. Dept. of the Interior, Minerals Management Service, Pacific OCS Region, Camarillo, CA. OCS Study MMS 2002-049.
- Schoch, D. 2006. In Long Beach, oil industry is an art form. Los Angeles Times. September 17: Los Angeles, CA.
<http://the.honoluluadvertiser.com/article/2006/Sep/17/bz/FP609170308.html>.
- Scholz, A., C. Steinback, S. Kruse, M. Mertens and M. Weber. 2008. Commercial and recreational fishing grounds and their relative importance off the North Central Coast of California. Ecotrust. Portland, OR.
- Schroeder, D.M. and M.S. Love. 2004. Ecological and political issues surrounding decommissioning of offshore oil facilities in the Southern California Bight. Ocean and Coastal Management 47(1-2):21-48.

- Second International Workshop on Human Factors in Offshore Operations. 2002. 2nd International Workshop on Human Factors in Offshore Operations.
- Showalter, M. 2005. As Oil rigs multiply, workers are scarce; Oil rig companies look to attract workers with better pay and benefits. *Investor's Business Daily*. August 22:Los Angeles, CA. <http://nl.newsbank.com/nl-search/we/Archives>.
- Shrimpton, M. and K. Storey. 2001. The effects of offshore employment in the petroleum industry: A cross-national perspective. U.S. Dept. of the Interior, Minerals Management Service, Environmental Studies Program, Herndon, VA. OCS MMS Study 2001-041.
- Smith, E. 1995. Trends in public opinion on offshore oil development in California: Final technical summary. U.S. Dept. of the Interior, Minerals Management Service, Environmental Studies Program. Santa Barbara, CA. OCS Study, MMS 95-0037.
- Smith, E. 2002. *Energy, the environment, and public opinion*. Lanham, MD: Rowman & Littlefield Publishers, Inc.
- Smith, E. 2003. Support for Offshore Oil and Gas Drilling Among the California Public.
- Smith, E., J. Carlisle and K. Michaud. 2005. Public attitudes toward oil and gas drilling among Californians: Support, risk perceptions, trust, and nimbyism. U.S. Dept. of the Interior, Minerals Management Service, Pacific OCS Region, Camarillo, CA. OCS Study MMS 2005-004.
- Smith, E. and S. Garcia. 1995. Evolving California opinion on offshore oil development. *Ocean and Coastal Management* 26(1):41-56.
- Smith, E. and K. Michaud. 2004. Public Opinion about Energy Development: Nimbyism vs. Environmentalism, Annual Meeting of the American Association of Public Opinion Research, Phoenix, AZ.
- Sollen, R. 1998. *An ocean of oil: A century of political struggle over petroleum off the California coast*. Juneau, AK: Denali Press.
- Southern California Trawlers Association. 1998. Southern California Trawlers Association perspective. In: Manago, F. and B. Williamson. *Proceedings: Public Workshop, Decommissioning and Removal of Oil and Gas Facilities Offshore California: Recent Experiences and Future Deepwater Challenges*. Santa Barbara, CA: Coastal Research Center, Marine Science Institute, University of California.
- State of California v. Gale Norton. 2002. United States Court of Appeals for the Ninth Circuit. December 2.
- Steinback, C. and S. Kruse. 2009. Overview of fisheries uses and values project in support of the Marine Life Protection Act (MLPA) Initiative (North Coast Study Region). Ecotrust. Portland, OR.

- The Subcommittee on Royalty Management. 2007. Report to the Royalty Policy Committee Mineral Revenue Collection from Federal and Indian Lands and the Outer Continental Shelf.
- Thompson, M. 2009. Response to Bush Administration proposal for drilling. Press Releases. <http://mikethompson.house.gov/PRArticle.aspx?NewsID=311>.
- Tuholski, N., H. Gluver, C.A. Cornell, B. Gerwick and R. Patev. 2002. Risk Assessment Procedures for Innovative Navigation Projects.
- Twachtman, R. 1997. Offshore-platform decommissioning perceptions change. Oil & Gas Journal 95(49):38-41.
- U.S. Congress, House Committee on Government Reform and Oversight. 1996. Crude Oil Undervaluation: The Ineffective Response of the Minerals Management Service. U.S. Congress, House Committee on Government Reform and Oversight. Washington, D.C.
- U.S. Dept. of the Interior, Minerals Management Service (MMS). 2001. Delineation Drilling Activities in Federal Waters Offshore Santa Barbara County, California Draft Environmental Impact Statement. U.S. Dept. of the Interior, Minerals Management Service, Pacific OCS Region. Camarillo, CA. OCS EIS/EA MMS 2001-046.
- U.S. Dept. of the Interior, Minerals Management Service (MMS). 2008. Collisions - Statistics and Summaries. May 5, 2009. <http://www.mms.gov/incidents/collisions.htm>.
- U. S. Dept. of the Interior, Office of Inspector General. 2007a. Investigative Report: Minerals Management Service False Claims Allegations. U.S. Dept. of the Interior, Office of Inspector General. Washington, D.C.
- U. S. Dept. of the Interior, Office of Inspector General. 2007b. Investigative Report: On the Lack of Price Thresholds in Gulf of Mexico Oil and Gas Leases. U. S. Dept. of the Interior, Office of Inspector General. Washington, D.C.
- U. S. Dept. of the Interior, Office of Inspector General. 2008. Investigative Report: MMS Oil Marketing Group Lakewood. U.S. Dept. of the Interior, Office of Inspector General. Washington, D.C.
- U.S. Dept. of Justice. 2001. Unocal to pay U.S. more than \$21 million for underpayment of oil royalties. Press Release. http://www.usdoj.gov/opa/pr/2001/December/01_civ_624.htm.
- U.S. General Accounting Office. 1998. Federal Oil Valuation: Efforts to Revise Regulations and an Analysis of Royalties In Kind. U.S. General Accounting Office. Washington, D.C. GAO/RCED-98-242.
- Vesseltracker.Com. 2009. May 5, 2009. <http://www.vesseltracker.com/app>.
- Wallace, N. 2000. Chevron suggests a Sing-Sing at sea. Santa Barbara News-Press. October 1:Santa Barbara, CA.

<http://www.newspress.com/Top/Article/article.jsp?Section=ARCHIVESW&ID=563126558986993677&Archive=true>.

Walters, H. 2003. Trip to Long Beach oil fields. Business Weekly. February 3:http://www.businessweek.com/innovate/next/archives/2009/02/trip_to_thums_1.html.

Weintraub, D. 2008. Don't expect new drilling off the coast anytime soon. Sacramento Bee. July 16: Sacramento, CA. <http://www.sacbee.com/opinion/v-print/story/1085460.html>

Welch, W. 2008. Calif.'s memories of 1969 oil disaster far from faded. USA Today. July 14: Arlington, VA. <http://nl.newsbank.com/nl-search/we/Archives>.

Wiley, P., V. Leeworthy and E. Stone. 2006. Economic Impact of Beach Closures and Changes in Water Quality for Beaches in Southern California. National Oceanic and Atmospheric Administration, National Ocean Service, Special Projects. Silver Spring, MD.

28. SUMMARY OF OIL AND GAS IMPACTS

The development of oil and gas will lead to a set of disturbances to the physical and biological components of the Southern Study Area. Some activities may not result in noticeable effects; however, all alterations to the environment must be considered in order to accurately assess the changes these anthropogenic activities will produce.

28.1 INSTALLATION, OPERATION, AND REMOVAL

Installation of offshore platforms includes surveying, pile driving, dredging, and pipeline laying, all of which result in increased noise levels, degradation of water quality, and increased vessel traffic. Increased turbidity may result from construction activities; the degree of impact depends on suspended sediment concentration, sediment type (grain size), and length of exposure. Vessel traffic results in a multitude of alterations to the environment which have the potential to cause impacts; increased anchoring and mooring lines, increased potential for ship strikes, and increased entrainment and impingement of organisms, among other factors, have the potential to negatively impact individual organisms, species, and the food web on the whole. Removal of offshore platforms includes many of the same procedures as their installation. The structures and decks above the surface are taken apart and shuttled to disposal sites via barges, which generates increased vessel traffic. The platform legs, wellheads, flare piles, conductors, submerged wells, caissons, and all other submerged structures then need to be removed to at least five meters below the sea floor.

Operational impacts may occur, resulting from fuel leaks and spills; discharge of drill cuttings, fluids, and produced water; habitat alteration due to increased structure; and the leaching of chemicals from the installed structures (e.g., paints, antifouling agents). Drilling cuttings and fluids are discharged as part of exploratory and developmental drilling. While oil-based drilling fluids have never been permitted for discharge, cuttings and water-based fluids could decrease water quality locally by increasing suspended sediment and pollutant concentrations and reducing light availability. Produced water, a waste product of oil production, is also discharged into the surrounding environment. This fluid, which contains more salt than seawater and may also contain a multitude of contaminants, has been shown to negatively affect the fouling community on structures nearby. The added structure resulting from installed platforms promotes the establishment of artificial reef habitat. This can influence biological processes both above and below the water surface. This habitat alteration has been observed and is well documented at several previously installed offshore structures in the Southern Study Area. Oil development produces hydrogen sulfide (H₂S), an odorless, toxic gas. H₂S is produced naturally during the decay of organic material and is found in petroleum. Antifouling paints and coatings are used to keep organisms from growing on structures submerged in the water. The use of antifouling paint has the potential to impact the water quality by leaching chemicals that can bioaccumulate in lower trophic organisms in the immediate vicinity.

28.2 OIL SPILLS

Spills of any kind, large or small, can have impacts on marine organisms and can affect the environment through several pathways. One way is through physical contact and the uptake of

toxic dissolved chemicals. The effects of physical oiling include smothering, irritation, impaired locomotion, contamination of offspring, inadvertent consumption, and death. The most sensitive groups to oil spills are birds and fur-bearing mammals; contact with only a small amount of oil can impair the thermal regulation barriers of mammals (fur) and birds (feathers).

In addition to physical impairments resulting from being coated in oil, organisms can also be affected by changing water quality conditions and toxic effects of hydrocarbons. The toxicity of oil to plankton, as well as to larger organisms, is largely due to exposure to and uptake of polycyclic aromatic hydrocarbons (PAHs), with the effects of the mixture of hydrocarbons being additive. This influx of PAH has the potential to affect the chemical composition of the area, in addition to its effects on the biological community by direct toxicity and bioaccumulation throughout the food web.

29. SUMMARY OF DATA GAPS

This chapter summarizes the data gaps for each oceanographic discipline covered in the report, including both resources and impacts, which are identified separately within each discipline, where sufficient detail warrants. For more detail, refer to the “Summary and Data Gaps” section of each chapter.

29.1 PHYSICAL OCEANOGRAPHY

29.1.1 Resource Data Gaps

Winds and currents have a distinct seasonal cycle, and scientists are learning more about the shorter-term variations, such as short-term coastally trapped wind reversals, and longer-term cycles that are influenced by the larger Pacific Ocean setting. Predictions of the circulation of currents in the Southern Study Area work well in the mean, but sudden shifts or reversals in winds and currents can be challenging if not impossible to predict. Further understanding of the dynamics related to both longer and shorter circulation time scales could improve simulations and predictions of changes in dependent biological systems and trajectories of any potential oil spills.

Information at a variety of scales in extending our understanding of long-term trends and providing information on seasonal transitions in the Southern California Current System (SCCS). Continuing long-term observations, such as the CalCOFI data, will improve our understanding of changes in the SCCS. Observations are needed to confirm how changes in the California Current System overall related to changes in the Southern California Bight.

29.1.2 Impact Data Gaps

Subtidal temperature changes are correlated with the large scale along-shore pressure gradient while upper ocean CalCOFI temperature trends are correlated with PDO. Salinity, though not correlated with the PDO, is correlated with the NPGO. The latter correlation suggests that sea surface temperature may be locally forced (by wind and heat flux), while salinity is forced more remotely. More observational data at a variety of scales is needed to understand the connection between cyclical variations (e.g. El Niño, PDO, NPGO), water column properties, and the dynamics in the SCB.

Development of efficient computation codes to allow engineers to test proposed structures with the local circulation would allow agencies to evaluate structures before they are constructed. Engineering developments that allow oil and gas development with minimal infrastructure would also assist in reducing the secondary effects such as sediment scour, increases in local turbidity and habitat alteration that are caused by changes in water flows. The ability to extend this type of model to an array of structures would allow evaluation of the potential of invasives to utilize structures for migration.

29.2 GEOLOGICAL OCEANOGRAPHY

29.2.1 Resource Data Gaps

Data gaps include: (a) high-resolution bathymetric mapping of offshore features and identification and dating of mass-wasting features; (b) quantification of erosion and sediment-distribution changes related to climate change; (c) causes and temporal changes in fluid and gas expulsion related to leakage of hydrocarbon structures or hydrate disassociation; (d) determination of the effects of bedform migration on the shallow shelf; and (e) understanding the sustainable limits of oil and gas removal in areas of natural seeps; in particular, the levels at which removal will begin to mobilize underwater slides.

29.2.2 Impact Data Gaps

Sediment transport could be affected by oil and gas facilities, resulting in changes to some bedforms and turbidity currents, which in turn could affect some geological processes including the movement of sediment in and out of submarine canyons, and shoreline forms subject to erosion. Observations and analysis are needed to understand the role storms play in forcing sediment mobilization and transport and the effect of storm stress on the seafloor in the vicinity of oil and gas seafloor infrastructure.

There is a concern that if sufficient oil and gas reserves, and associated water and sediment, are removed, then slides and mass movements of sediment could occur. Since no observations have been done to determine this cause and effect, monitoring infrastructure and potential slide areas is needed. In addition, sufficient removal of reserves could result in localized seafloor collapse, so monitoring is needed.

Additional data is needed in order to understand the sustainable limits of oil and gas removal in areas of natural seeps; in particular, to understand the levels at which removal will begin to mobilize underwater slides.

29.3 CHEMICAL OCEANOGRAPHY

29.3.1 Resource Data Gaps

While the waters of the inner shelf in the study region have been thoroughly explored, the outer shelf and basins of the study region have been remarkably poorly explored. Recent discoveries of massive hydrate mounds, pockmarks, asphalt volcanoes and chemosynthetic communities in the study region underscore this point. The application of modern technology, such as autonomous underwater vehicle (AUV)-based imaging surveys, along with submarine and remotely operative vehicle (ROV)-based exploration, would greatly increase knowledge of the deep benthic communities and ecosystems that exist in the study region.

With the exception of the well-studied Coal Oil Point seeps, the literature concerning the locations and nature of offshore seepage for the study regions is insufficient by modern standards. A concerted effort to positively identify and precisely locate seeps, and to collect oil

and gas samples therefrom, would provide several benefits. Regions that are particularly poorly documented include the Santa Maria Basin and the offshore basins throughout the study region.

Methane is a potent greenhouse gas, with a global warming potential approximately 25-fold greater than that of CO₂ when averaged over the lifetime of the molecule. Distinguishing natural versus industrial emissions and understanding the fate of submarine emissions from natural or production operations may prove beneficial to the BOEMRE. This would also provide important information about the biogeochemistry of methane in the sea.

The potential for formation of dead zones in the waters of the study region is remote but also important. This region contains a strong suboxic zone in the intermediate waters, and the potential for oxygen deprivation in the surface waters should be considered. The geologic record suggests that waters of the Santa Barbara Basin may have become sulfidic in the past.

29.3.2 Impact Data Gaps

The weathering patterns of complex organic materials such as well cuttings, crude oil, or components of produced water remain only partially understood. Key questions include the pathways by which many compounds are broken down, and the toxicity potential of numerous intermediates present at low concentration. Targeted studies are needed that consider the fate of such compounds, with an emphasis on the natural compounds present in the study region.

Hydrogen sulfide gas and its ionic forms—sulfide and bisulfide—are abundant in many offshore oil and gas reservoirs and are toxic to most organisms. The fate of sulfide released into the ocean as a result of offshore operations should be further considered. Furthermore, organosulfur compounds that are abundant in many native oils of the region should be further investigated to determine their fate and impacts.

Leaching of biologically active chemicals (e.g. from paints and antifouling coatings), including butyltins (DBT, MBT and TBT), cadmium, copper, manganese, nickel, and zinc is a concern in coastal waters and sediments. Previous work indicates that butyltins have the potential to be distributed widely, and deeper sediments should be investigated. Baseline and monitoring studies of release rates and accumulation copper, butyltin and potentially other trace metals in water, tissues, and sediment would help to fill this gap. Monitoring for effects needed to include not just mortality associated with these chemicals, but also changes in species abundance and movement.

Complete platform removal during decommissioning will lead to a local benthic species composition shift toward a soft sediment community (if the shell mound is removed) or to a community similar to one inhabiting areas with low-relief cobble (if the shell mound is left in place). Major issues identified include the likelihood that contaminated sediments are resuspended in the water column as well as the damage to soft sediment communities.

The negative effects of increased vessel traffic in the Southern California Bight include a higher risk of discharges and spills, leaching of bottom paints, and increased atmospheric pollution from ship exhausts. While the processes governing surface oil slicks have been studied for decades,

the weathering and transport processes of sinking oil are largely unstudied, particularly for oils denser than seawater. There is an information need to quantify the cumulative effects of toxic chemicals leaching from the hulls of ships and ship exhaust fumes from engines powered by fossil fuels.

Produced waters contain metals and dissolved hydrocarbons that must be reduced as much as possible before the effluent can be discharged to the sea. Studies show clearly that sublethal effects can occur at anticipated concentrations within 100 m of any produced water discharge in the offshore California OCS. Also, while radium isotopes have been identified in produced waters from oil production wells in the Gulf of Mexico and terrestrial locations throughout the United States, no data were available on produced waters in the SCB.

An issue of public interest is whether offshore oil production reduces rates of natural petroleum seepage and can thus be considered as a factor mitigating impacts of offshore oil activity. This issue requires additional scientific consideration.

29.4 PHYTOPLANKTON, ZOOPLANKTON, PELAGIC INVERTEBRATES

29.4.1 Resource Data Gaps

Cross-shelf comparisons of chlorophyll production and phytoplankton are common for this region. However, little work has been done to quantify the change in the zooplankton community over similar spatial scales. While it is noted that the offshore regions are fairly oligotrophic and do not support the same abundances, there has not been a comprehensive look at community dynamics. These dynamics are well-studied off the coasts of Oregon and Northern California, but they have not been widely investigated in the Southern California Bight.

Vertical spatial variability also needs to be further explored. The CalCOFI cruises sample for zooplankton by sampling over the entire water column. While this data set is an excellent resource, it does not allow for depth-stratified analyses. Further research would help to classify the neuston community in the Southern California Bight, which would be the most impacted portion of the plankton community in the event of an oil or gas spill.

Information on larger pelagic invertebrates is not complete. Gelatinous species are important parts of the marine food web as they can be predators and competitors with larval fish. Larger species represent a separate branch of the food web, in which production consumed becomes unavailable to fish and other members of the traditional food web. Information regarding this community is needed to fully assess production within the system and potential impacts of offshore oil and gas development.

29.4.2 Impact Data Gaps

Larger pelagic invertebrates are more susceptible to development activities and spills because they have slower growth rates and smaller populations, and may not continuously reproduce. Toxicity of oil and PAHs to this group has not been widely studied. This is an important data gap, as several species are commercially harvested.

29.5 MACROPHYTES

There is little updated information that describes seagrasses and other coastal macrophyte habitats in as much detail as presented in Murray and Bray (1993). In addition, more research is needed to determine the best methods for removing oil that do not significantly harm or alter the recovery rates of these highly productive, and increasingly rare, habitats.

29.6 BENTHOS

29.6.1 Resource Data Gaps

Further investigation of top-down and bottom-up ecological processes in rocky intertidal habitats is needed. Understanding these processes can be important in revealing determinants of community structure. Increased attention by researchers and funding agencies to benthic–pelagic coupling would dramatically enhance understanding of the dynamics of coastal rocky ecosystems. Such investigations will augment data existing on zonation of intertidal and subtidal rocky areas.

Further investigation of response to variation in the presence or loss of kelp in subtidal rocky habitats is necessary. This would increase understanding of the ecological processes that structure the Californian kelp forest communities. In addition, the large differences in benthic invertebrate recruitment rates across biogeographic scales highlight the need for better understanding of larval response to ocean circulation patterns.

Deep-sea habitat exploration and characterization are an important future research need especially when considering the effects of anthropogenic threats (i.e. increased deep-sea fishing, oil and gas exploration, and ocean warming).

29.6.2 Impact Data Gaps

Benthic recovery of disturbed habitats is an important area of research. An important ecological question is: Are the benthic communities that develop after a disturbance supply the same food web services (e.g. energy transfer) as the original communities? For this question to be answered, comprehensive information on pre- and post- disturbance processes must be documented. These data gaps should be the focus of future seabed recovery studies.

29.7 FISH

29.7.1 Resource Data Gaps

Further understanding of existing distributional patterns and fish biogeography in the Southern Study Area and regions to the north is needed. Assessment of effects of climate change on fish distributions will be dependent on quality of long-term data sets, species range data, ecosystem response information, and trends in short-term climatic regime shifts. Continued long-term, standardized, fisheries-independent quantitative studies should be undertaken, examining populations of groundfish and pelagic fish stocks.

Comparative studies of rocky intertidal fishes and their subtidal relatives is an important future research topic. It is important to understand how residents of the rocky intertidal differ and what adaptations have been developed to enable them to live in such a demanding environment. Future research should also include monitoring and measuring the response of rocky subtidal and intertidal fish communities to additive effects of development, oil spills, climate change, and climate regime shifts.

The effects of climate change on kelp forest species composition are an important data gap. As sea surface temperatures increase, and various species ranges are either limited or extended, it will be important to understand how kelp forest communities are affected, and how the loss of kelp habitat affects various associated fish species.

Trophic cascades, as well as top-down and bottom-up effects in the food web, are important research topics in addressing how fishery exploitation, climate change, and coastal and offshore development can impact ecosystems of the Southern Study Area.

29.7.2 Impact Data Gaps

Sensitivity of fish eggs and larvae to toxic, or potentially toxic, by-products of oil and gas development such as produced water and drill cuttings is an area of research needing further attention.

29.8 SEA TURTLES

29.8.1 Resource Data Gaps

While much more information about these long-lived species is becoming available with the advancement of satellite-telemetry technology, little remains known about their post-hatchling stages. Additionally, comprehensive population estimates are hard to compile because of the solitary nature and wide distribution of individuals.

29.8.2 Impact Data Gaps

There is a good body of literature that reports turtle life history and observations in the environment. It is also known that direct encounters with oil can adversely affect turtles. However, little information exists regarding specific behavioral changes that result from encountering floating oil, which might affect future exposure as well as migratory and reproductive behavior. Understanding how turtles respond to oil slicks would allow for much more accurate assessment of impacts. Both short- and long-term data are needed to completely address this issue, as these long-lived individuals could cease to return to a given location if an oil slick had previously been encountered.

29.9 BIRDS

29.9.1 Resource Data Gaps

Comprehensive reports on seabirds and shorebirds are readily available; however, the light-footed clapper rail is one of the only marshbirds for which there is a recurring census in the

Southern Study Area. Many bird populations have declined due to reduction and degradation of habitat, and therefore would benefit greatly from monitoring programs.

29.9.2 Impact Data Gaps

Avian mortality after oil spills continues to be difficult to quantify accurately because of the high motility of birds and the multiple pathways by which they are affected by oil exposure. Accurate impact assessments are necessary to quantify loss to ecosystems, and models have offered some assistance with this problem. However, because models are based on empirical data from historical spills, mortality estimates may still not be accurate for the situation at hand.

Assessments of the impacts of construction noise on birds are often not performed for environmental impact statements for oil and gas development. However, adverse impacts may occur as a result of the assumed behavior to vacate an area of high noise; thus, this is an important topic in sensitive areas such as feeding and nesting sites. These areas are integral in the breeding success of bird species and need to be considered. Furthermore, many sea birds spend time diving underwater. Sound travels much differently in the aqueous environment than in air, and the effects of sound on mammals and fish are of concern and so continue to be studied. These studies should also extend to birds that spend time underwater and therefore may be affected by increased sound.

29.10 MARINE MAMMALS

29.10.1 Resource Data Gaps

Key data gaps for marine mammals include: (a) continued assessments of marine mammal abundance due to their changes in population status; (b) better information on seasonal occurrence; (c) baseline data at finer spatial scales than currently available for locations where activities are planned; and (d) data on species with greater vulnerability to oil and gas activities or which are endangered, including sea otters and northern fur seals, coastal bottlenose dolphins, and blue, fin, and humpback whales.

29.10.2 Impact Data Gaps

Much of the research on the impacts of oil and gas on marine mammals took place in the 1970s and 1980s. Many of the data gaps identified then still remain. Areas requiring additional study are: (a) better understanding of long-term impacts of oil exposure; (b) better understanding of the impacts of underwater sound (some of this work should focus on the hearing sensitivity of marine mammal species); and (c) improved determination of ship strike threat and ways to reduce their occurrence.

29.11 ECOSYSTEM RELATIONSHIPS

29.11.1 Resource Data Gaps

Whole-ecosystem evaluations are uncommon because they require large data sets taken over many years to make analysis worthwhile. This is a time-consuming and expensive procedure. The Southern California Bight has been relatively well studied by projects including the

California Cooperative Oceanic Fisheries Investigation (CalCOFI) and the work done by the Channel Islands Marine Sanctuary. Continuation of these valuable studies will allow monitoring and analysis of the effects of climate change and further development of offshore oil and gas.

29.11.2 Impact Data Gaps

Ecosystem impacts of oil and gas production include loss of biomass after a spill or construction activities. Some modeling work has been performed to quantify this impact; however, more work quantifying this reduction is needed to fully understand the cascading effects. In general, the creation of artificial reefs is perceived as a positive impact of offshore development. This concept needs to be reevaluated in terms of bioinvasion pathways and the health of organisms found on these reefs. These reefs may provide nonnative and potentially invasive species with enough habitat to allow them to increase their range and move into pristine habitats. Additionally, fouling organisms found on these artificial structures could bioaccumulate toxins due to the close proximity to pollutants. These toxins have the potential to move up the food web as predators are attracted to the artificial reefs because of the high concentration of biomass.

29.12 AREAS OF SPECIAL CONCERN

In recent decades much of the sensitive land and water in the Southern Study Area has received protection in the form of sanctuaries and reserves. Similarly, artifacts of ancient and modern cultures can be found in this area and need to be protected and preserved. To prevent accidental disturbance of these sensitive areas they need to be accurately mapped. This can be a challenge as not all historical locations have been discovered.

29.13 SOCIOECONOMICS

The significance of space-use conflicts can be assessed, in the case of commercial fisheries, by examining the spatial and temporal nature of typical fishing activities. Databases maintained by the Pacific States Marine Fish Commission (PSMFC) are useful in this respect. The Pacific Fisheries Information Network (PacFIN) provides timely and accurate data essential for effective fisheries management.

The West Coast Groundfish Observer Program, operated by the National Marine Fisheries Service (NMFS) Northwest Fisheries Science Center, places observers on commercial fishing vessels to monitor and record catch data, including species composition of retained and discarded catch. The objective of this program is the provision of accurate accounts of total catch, bycatch, and discards associated with different fisheries and fish stocks.

Taken together, the above data sources facilitate evaluation of the potential impacts of offshore oil and gas development on commercial fisheries. While these data sets contain extensive catch information, there are limited data on fishing effort, catch per unit of effort and harvesting costs both spatially and temporally. Research to address these data gaps would improve the ability to evaluate the impacts of energy-related activities.

With respect to recreational fisheries, spatial conflicts can be assessed using the Pacific Recreational Fisheries Information Network (RecFIN) database. California and NMFS

contribute to the database maintained by the PSMFC. RecFIN is designed to integrate State and Federal marine recreational fishery sampling efforts into a single database that provides data on catch, effort, economics, and fisher demographics.

The Marine Recreational Fisheries Statistics Survey (MRFSS) generates independent estimates of effort and catch through two separate survey components, a bimonthly household telephone survey, and a continuous onsite, access-point intercept survey of angler fishing trips.